

ОБЩИЙ ПЕРЕЧЕНЬ

Полный ассортимент наших
промышленных подшипников





Опыт завода-производителя, Масштаб лидера

NTN-SNR ROULEMENTS, входит в состав третьей мировой корпорации по производству подшипников и является ведущим проектировщиком, разработчиком и производителем.

Благодаря сильным брендам компании, NTN-SNR активно работает в автомобильной отрасли, промышленности и авиастроении. Каждое подразделение отвечает ожиданиям глобального рынка и сконцентрировано на сегментах деятельности своих клиентов.



NTN-SNR предлагает техническую продукцию высшего качества и располагает профессиональными решениями.



Имея самый широкий ассортимент на рынке, наш коллектив отвечает и на другие требования. Так, инновации являются решающими в нашем развитии: предвидение новых решений, обогащение функциональности подшипника и т.д.

Более компактные, более лёгкие, более экономичные, более надежные, более высокопроизводительные, более экологичные... мы интенсивно вводим новшества с нашими клиентами и для них.

Компания NTN-SNR, решительно ориентированная на экологические рынки, известна как партнер-разработчик компаний будущего. Компания NTN-SNR готова использовать все возможности рынка.



Вместе мы строим мир будущего

Специфика компании NTN-SNR основана на крепких, конкретных и общепринятых ценностях.

Близость к клиентам, профессионализм, качество, мастерство: эти ценности нас вдохновляют вот уже около 100 лет.

Индивидуально и совместно мы берем на себя важные обязательства: внимательное обслуживание и эффективность для тех, с кем мы работаем, живем и кого мы обслуживаем.



NTN-SNR, With You (С вами)

Содержание

Подшипник: технические характеристики

• Обозначение.....	стр. 2
• Компоненты и терминология	стр. 4
• Стандартные серии и обозначение.....	стр. 5
• Вал и корпус	стр. 6
• Уплотнения	стр. 6
• Нагрузки	стр. 7
• Зазоры	стр. 8
• Инструменты для монтажа и демонтажа.....	стр. 9
• Решения в области систем смазывания: Системы смазывания Lub'Solutions	стр. 10
• Оказание услуг	стр. 11
• Теоретические таблицы соответствия.....	стр. 12
- Стандартные подшипники	
- Подшипниковые узлы с самоустанавливающимися шариковыми подшипниками	
- Игольчатые подшипники	
• Суффиксы NTN и SNR	стр. 19
• Руководство для пользователя	стр. 24

Обозначения подшипников

• Классификация по кодам	стр. 25
• Классификация по размеру	стр. 325



With You

В центре событий,
в центре обмена опытом





Обозначение

Код данных изделий указан в перечне настоящего каталога, что позволяет быстро идентифицировать конструкцию подшипника

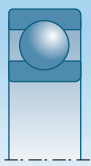

1

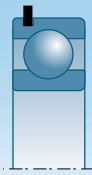

1-NR

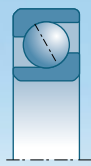

2

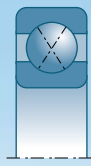

3

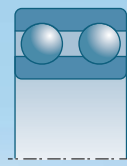

4

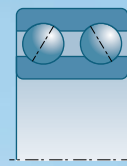

5

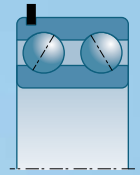

5-NR

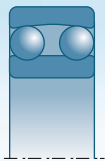

6

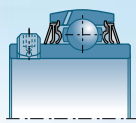

7

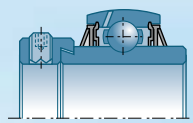

8



9

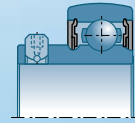

10

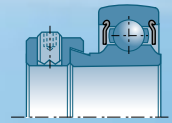

11

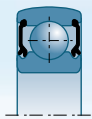

12

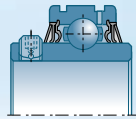

13

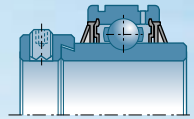

14

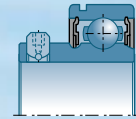

15

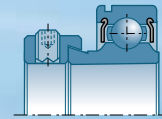

16

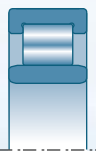

17

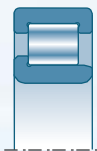

18

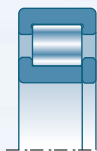

19

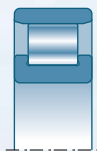

20



21



22

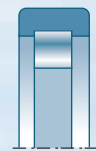

23



24

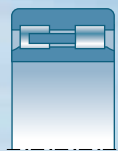

25

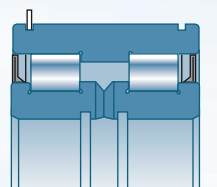

26

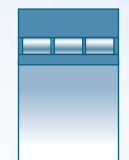

27

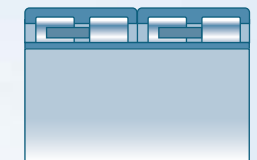

28

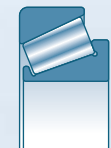

29



30

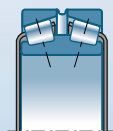

31

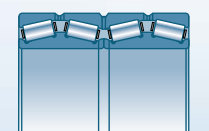

32



33



34

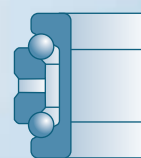

35



36



37

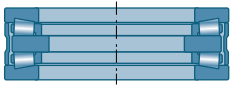

38

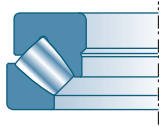

39



40

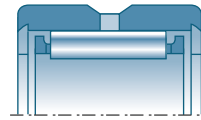

41

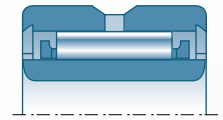

42

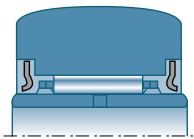

43

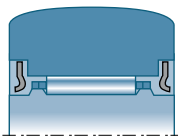

43A

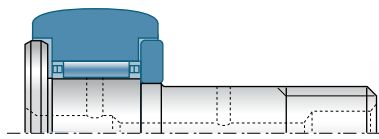

44



45

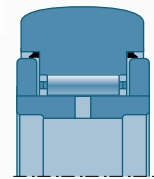

45-A



46



47



48



49



50

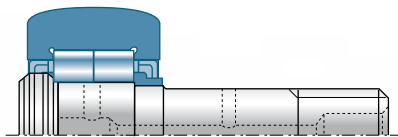

51

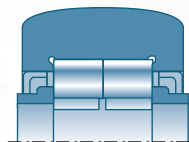

52

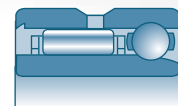

53

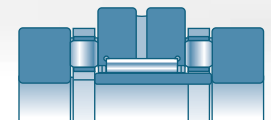

54



55

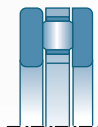

56

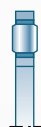

57



58



59

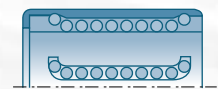



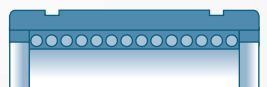





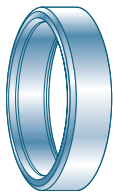
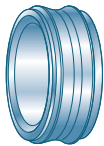



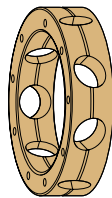
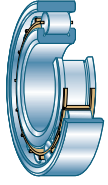
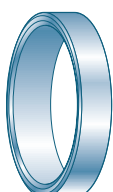

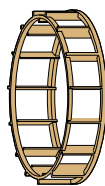

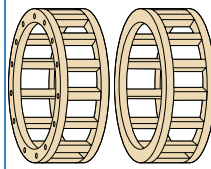
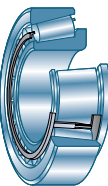
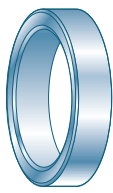
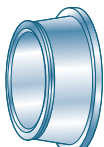



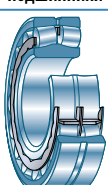
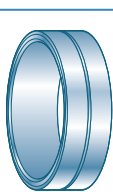
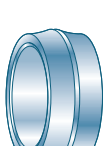

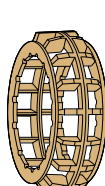
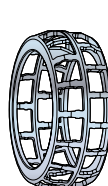
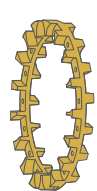
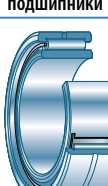
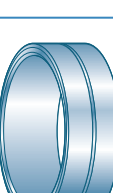
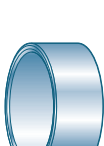

60

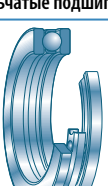
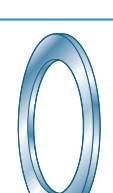

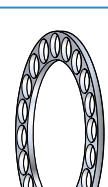
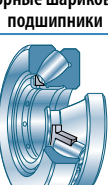
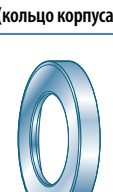
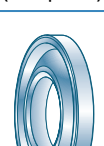
61

Компоненты и терминология

Тип	Наружное кольцо	Внутреннее кольцо	Тела качения	Сепараторы		
				Полимерный	Штампованный из стального листа	Массивный с механической обработкой
 Шариковые подшипники						
 Цилиндрические роликовые подшипники						
 Конические роликовые подшипники						
 Сферические роликовые подшипники						
 Игольчатые подшипники						
 Упорные шариковые подшипники						
 Упорный сферический роликовый подшипник						

Стандартные серии и обозначение

60 10

		КОД ОТВЕРСТИЯ	ДИАМЕТР ОТВЕРСТИЯ (мм)		
	Радиальные одно- или двухрядные шариковые подшипники Стандартный Защитная пластина с одной или двух сторон Одно- или двухстороннее уплотнение Со стопорным кольцом NR Двухрядный шариковый	КОД СЕРИИ Однорядный 600 16000 620 6000 630 6200 6300 6300 6400 6400 6700 6700 6800 6800 6900 6900	КОД СЕРИИ Двухрядный 4200 4300	3	3
		КОД СЕРИИ Однорядный 7000 С или Н* 7200 В, С или Н* 7300 В, С или Н* 71900 или 7900С или Н или АD 7800 (*высокоточный)	КОД СЕРИИ Двухрядный 3200 3300 5200 (открытый или с уплотнением) 5300 (открытый или с уплотнением)	4	4
	Радиально-упорные одно- или двухрядные шариковые подшипники Тип В α = 40° Тип С α = 15° Тип Н α = 25° Однорядный (α = Стандартный = 30°) Двухрядный			5	5
		Двухрядные самоустанавливающиеся шариковые подшипники Цилиндрическое отверстие Коническое отверстие К С уплотнением		КОД СЕРИИ 1200 - 1300 2200 - 2300 (открытый или с уплотнением)	6
	Одно- или многорядные цилиндрические роликовые подшипники Тип N NU NJ NUP NN SL 4R Однорядный Двухрядный Четырехрядный	КОД СЕРИИ Однорядный N, NU, NJ, NUP, NF 200 - 300 - 400 1000 2200 - 2300 доступный в исполнении К	КОД СЕРИИ Двухрядный NN, NNU 3000 3900 4000 4900 SL доступный в исполнении К	8	8
		КОД СЕРИИ МЕТРИЧЕСКИЕ РАЗМЕРЫ 30200 30300 31300 или 32300 В 30300 D 32000 32200 32200 В Серия по ISO 355	КОД СЕРИИ ДЮЙМОВЫЕ РАЗМЕРЫ А Е ЕЕ Н НН НМ ЛМ М JM, JNM, JLM...	9	9
	Конические роликовые подшипники Однорядный Двухрядный Четырехрядный			00	10
		Сферические роликовые подшипники Без буртика Без центрального буртика С буртиком С уплотнением		КОД СЕРИИ Двухрядный 21300 23900 22200 24000 22300 24100 23000 24800 23100 24900 23200 23300 23800	01
	Упорные шариковые, упорно-радиальные роликовые или сферические подшипники Шариковый Роликовый	КОД СЕРИИ шарикового подшипника 51100 51200 51300	КОД СЕРИИ роликового подшипника 29300 29400 29300 E 29400 E	02	15
		Игольчатые подшипники - Кулачковые ролики Кулачковый ролик с осью Кулачковый ролик без оси Игольчатый подшипник	Игольчатые подшипники Игольчатые втулки Сепараторы с иголками Упорные игольчатые подшипники Комбинированные игольчатые подшипники Кулачковые ролики с осью или без оси	03	17
	Подшипниковые узлы 	Корпуса подшипников Разъёмный корпус типа SNC Специальный корпус	Разъёмные корпуса для шариковых или роликовых подшипников.	04	04x5 = 20
			Самоустанавливающиеся подшипниковые узлы со сферической наружной поверхностью наружного кольца подшипника.	51100 51200 51300	29300 29400 29300 E 29400 E
				06	06x5 = 30
				07	07x5 = 35
				08	08x5 = 40
				...	
				/500	500
				...	
				/1200	1200

Вал и корпус

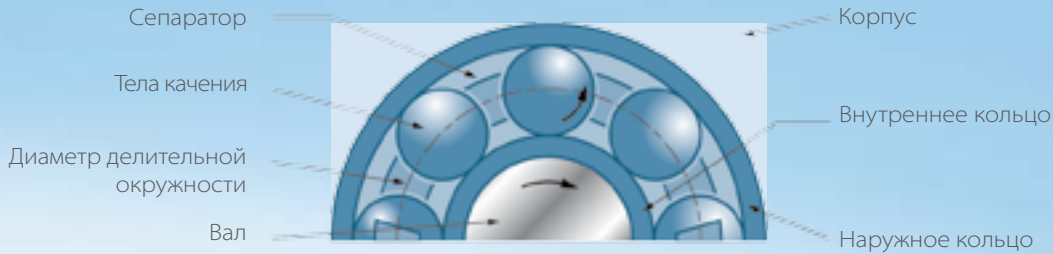

Уплотнения

Тип уплотнения	Характеристики	Суффиксы	
Защитная пластина	Металлическая Стальная штампованная	-Z / -ZZ (NTN) 	-Z / -ZZ (SNR)
Уплотнение	Стандартное контактное Нитрил	-LU / -LLU (NTN) T°: -25°C / +120°C	-E / -EE (SNR) T°: -25°C / +120°C
Уплотнение	Бесконтактное (с лабиринтным эффектом) Нитрил	-LB / -LLB (NTN) T°: -25°C / +120°C	
Уплотнение	Контактное с пониженным трением и системой уравнивания контактного давления Нитрил	-LH / -LLH (NTN) T°: -25°C / +120°C	
Уплотнение	Стандартное контактное высокотемпературное (+150 °C) Полиакрил	-LUA / -LLUA (NTN) 	
Уплотнение	Стандартное контактное для ультравысоких температур (+200 °C) Фторкаучук	-LUA1 / LLUA1 (NTN) 	E3 (SNR)
Уплотнение	Стандартное контактное для экстремальных температур (от -100 до +200 °C) Силиконкаучук	-LUA2 / -LLUA2 	

Нагрузки

РАСПРЕДЕЛЕНИЕ НАГРУЗОК НА ПОДШИПНИКЕ

РАДИАЛЬНЫЕ НАГРУЗКИ

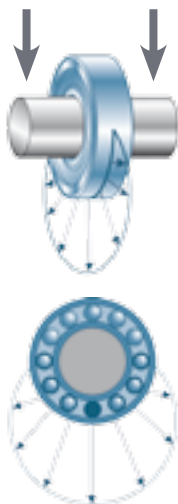

Сектор не более 180°

ОСЕВЫЕ НАГРУЗКИ

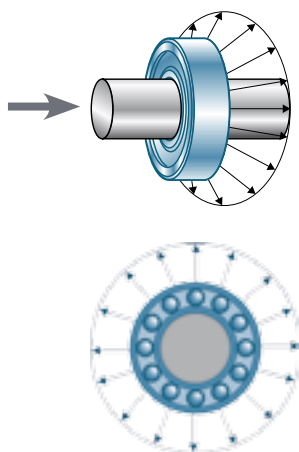

Распределение по окружности 360°

КОМБИНИРОВАННЫЕ НАГРУЗКИ

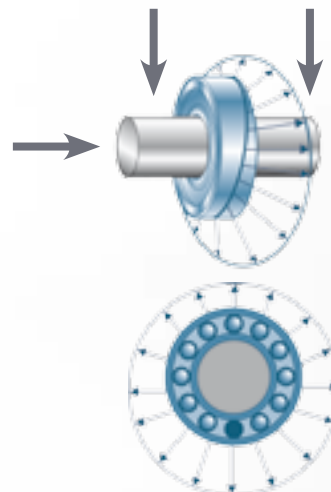

Неравномерное распределение

НАГРУЗОЧНАЯ СПОСОБНОСТЬ РАЗЛИЧНЫХ ПОДШИПНИКОВ

ШАРИКОВЫЕ ПОДШИПНИКИ

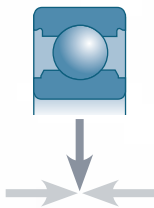

Умеренные радиальная и осевые нагрузки

РАДИАЛЬНО-УПОРНЫЕ ОДНО- ИЛИ ДВУХРЯДНЫЕ ШАРИКОВЫЕ ПОДШИПНИКИ

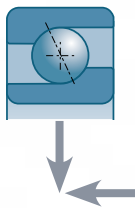

Комбинированные радиальная и осевая нагрузки (в одном направлении)

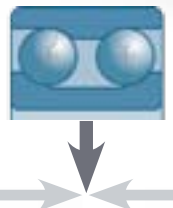

Радиальная нагрузка/осевая нагрузка (в двух направлениях)

САМОУСТАНОВЛИВАЮЩИЕСЯ ДВУХРЯДНЫЕ ШАРИКОВЫЕ ПОДШИПНИКИ

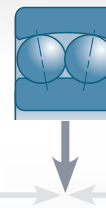

Умеренная радиальная нагрузка
Небольшая осевая нагрузка (в двух направлениях)
Несоосность допускается

ЦИЛИНДРИЧЕСКИЕ РОЛИКОВЫЕ ПОДШИПНИКИ

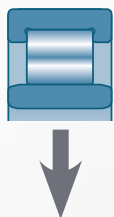

Очень высокая радиальная нагрузка
Нулевая осевая нагрузка

КОНИЧЕСКИЕ РОЛИКОВЫЕ ПОДШИПНИКИ

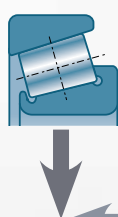

Очень высокая радиальная нагрузка
Высокая осевая нагрузка (в одном направлении)

СФЕРИЧЕСКИЕ РОЛИКОВЫЕ ПОДШИПНИКИ



Очень высокая радиальная нагрузка
Умеренная осевая нагрузка (в двух направлениях)
Несоосность допускается

УПОРНЫЕ ШАРИКОВЫЕ ПОДШИПНИКИ

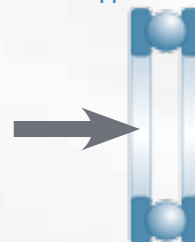

Очень высокая осевая нагрузка
Нулевая радиальная нагрузка

Зазоры

Нормативные требования к внутреннему зазору подшипников относятся только к радиальному зазору.

Стандарт ISO 5753.

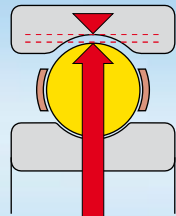

ДА

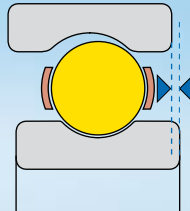

НЕТ

Этот радиальный зазор необходим, чтобы компенсировать следующие факторы:

- Деформации колец подшипника при монтаже вследствие наличия посадок

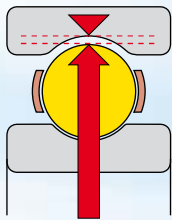

Начальный радиальный зазор

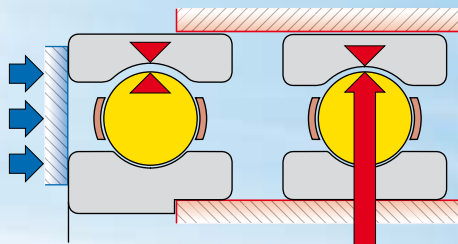

Остаточный радиальный зазор после монтажа

- Различная степень расширения внутреннего и наружного колец из-за различия рабочих температур.

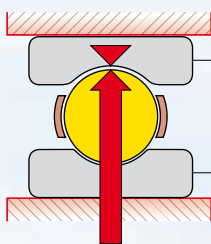

Рабочий радиальный зазор

Зазоры, используемые в станках, или высокая точность

- C9 уменьшенный зазор меньше C0
- C0 уменьшенный зазор меньше C1
- C1 уменьшенный зазор меньше C2

Стандарт ISO 5753

- C2 уменьшенный зазор
- CN нормальный зазор
- C3 увеличенный зазор
- C4 увеличенный зазор больше C3
- C5 увеличенный зазор больше C4

Специальные зазоры (NTN)

- CS специальный зазор
- CM специальный зазор (специально для электрических моторов)

Инструменты для монтажа и демонтажа

Монтаж и демонтаж подшипника — это основные этапы, которые определяют срок службы и работоспособность вашего оборудования.

**Experts
& Tools**



Монтаж в холодном состоянии:

Набор инструментов для безопасного, быстрого и точного монтажа подшипников.



Монтаж в горячем состоянии:

Индукционный нагрев: быстрый, практичный, простой, безопасный, надежный, экологичный и т. д.



Гидравлический монтаж:

Точный, не требующий приложения излишних усилий за счет использования гидравлической гайки, всегда готов к применению с функцией автоматического отвода поршня.



Инструменты для демонтажа:

Гидравлический или механический демонтаж:

Все типы съёмников (2 или 3 захвата) обеспечивают надёжный и чистый демонтаж независимо от расположения или размеров подшипника.



Инструменты:

Простое, безопасное и точное измерение рабочей температуры вашего оборудования за счет применения лазерного термометра.

И многие другие инструменты для монтажа и работ с подшипниками ...

Решения в области систем смазывания: Системы смазывания Lub'Solutions

LUB'SOLUTIONS: мы участвуем в смазывании от теории до практики, предлагая вам подобранные специально для вас смазочные материалы, а также системы одноточечной или многоточечной смазки, подходящие к параметрам и потребностям вашего технологического процесса.

Пластичные смазки

Они соответствуют специфике ваших условий и обеспечивают оптимальную работу ваших подшипников.



Universal



Heavy Duty



Vib



High Temp



Ultra High Temp



Food



High Speed+



Chain Oil



Автоматические одноточечные лубрикатеры



В рамках расширенного технического предложения в области систем смазки для подшипников мы предлагаем также решения, наиболее адаптированное к вашим условиям. Мы реагируем на все ваши потребности.



Централизованные системы смазки



Для централизованной подачи масла или консистентной смазки, предусмотренной вашим промышленным процессом, мы предлагаем различные типы насосов и вспомогательное оборудование: объёмная, поступательная, распылительная системы, циркуляционная, многолинейная или двухлинейная системы смазки. Сделайте свой выбор!



Проектирование и установка системы смазки



Специалисты LUB'SOLUTIONS всегда к вашим услугам для реализации ваших проектов смазки под ключ — от проектирования до монтажа. Никогда еще смазывание не было таким простым процессом!

Оказание услуг

Обучение



Предоставьте вашим сотрудникам (конструкторскому бюро, службе техобслуживания и т. д.) возможность пройти обучение по подбору и техобслуживанию подшипников. Предлагаем проведение индивидуализированного обучения, необходимого каждому клиенту в различной степени, которое объединяет теорию и практику, в нашем учебном центре или у вас на месте с использованием нашего спецавтомобиля VEBOX.

Кроме того, мы применяем дифференцированные методы обучения!

Диагностика подшипников



В нашей лаборатории или у вас на месте вы сможете узнать вместе с нашими экспертами причины отказов ваших подшипников. Их компетентность и предоставленные рекомендации позволят вам повысить производительность вашего оборудования.

Восстановление подшипников и ремонт шпинделей станков



Доверьте восстановление ваших промышленных подшипников и ремонт шпинделей станков предприятию, специализирующемуся на ремонте подшипников для машиностроения, авиационной промышленности и железнодорожного транспорта.

Техническая помощь выверка валов

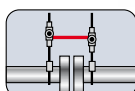

Вы можете доверить нашим экспертам контроль обслуживания: установка и демонтаж подшипников, установка и настройка систем смазывания, лазерная выверка валов.

Вместе с нашим спецавтомобилем-мастерской VEBOX наши специалисты приедут прямо к вам!

Аудит технического обслуживания



Воспользуйтесь преимуществами, полученными от беспристрастной оценки вашей организации технического обслуживания и ремонта, которая будет выполнена нашими специалистами по промышленному техобслуживанию. Повысьте производительность за счет плана действий, предлагаемого NTN-SNR.

Аренда инструмента



Служба Experts & Tools предлагает аренду широкого ассортимента крупного инструмента для техобслуживания ваших подшипников: индукционных нагревателей, гидравлических гаек и т. д.

Теоретические таблицы соответствия

Стандартные подшипники

Тип подшипника	Техническая характеристика	NTN	SNR	FAG	SKF	NSK
Однорядные шариковые Серии 6000-6700-6800 (61800)-6900(61900)-6000-6200-6300-6400 200-300-16000-16100 / BL200-BL300	Одна или две штампованные защитные пластины	Z / ZZ	Z / ZZ	ZR / ZZR	Z / ZZ	Z / ZZ
	Одно или два контактных уплотнения	LU / LLU	E / EE	RSR / ZRSR	RS1 / ZRS1	DU / DDU
	Одно или два бесконтактных уплотнения	LB / LLB		RSR / ZRSR	RZ / ZRZ	V / VV
	Канавка без стопорного кольца/со стопорным кольцом	N / NR	N / NR	N / NR	N / NR	N / NR
	Внутренний зазор (если отличается от нормального радиального зазора)	C2 / C3 и т.д.	C2 / C3 и т.д.	C2 / C3 и т.д.	C2 / C3 и т.д.	C2 / C3 и т.д.
Двухрядные шариковые Серии 4200-4300	Полиамидный сепаратор		Без суффикса		TN9	TNG
	Без паза для заполнения		A		A	B
	Внутренний зазор (если отличается от нормального радиального зазора)		J20 / J30 и т.д.		C2 / C3 и т.д.	C2 / C3 и т.д.
Радиально-упорные однорядные шариковые подшипники (стандартная серия) Серии 7000-7800(71800)-7900(71900)-7200-7300-7400	Угол контакта 40°	B	B	B	B	B
	Угол контакта 15°	C	C		E	C
	Полиамидный сепаратор	T2	A	TVP	P	T85/TYN
	Штампованный стальной сепаратор	Без суффикса			J	W
	Массивный латунный сепаратор	L1	M	MP	M	Без суффикса
	Для установки в тандем	G	G	UA / UO	CB / G	G / SU
Двухрядные самоустанавливающиеся шариковые подшипники Серии 1200-1300 2200-2300-100 11200-11300-11500	Штампованный стальной сепаратор	J	Без суффикса		Без суффикса	Без суффикса
	Полиамидный сепаратор	T2	G15	TV	TN, TN9	TNG
	Два контактных уплотнения		EE	2RS	2RS1	2RS
	Внутренний зазор (если отличается от нормального радиального зазора)	C2 / C3 и т.д.	J20 / J30 и т.д.	C2 / C3 и т.д.	C2 / C3 и т.д.	C2 / C3 и т.д.
	Коническое отверстие 1:12	K	K	K	K	K
Радиально-упорные однорядные шариковые подшипники Серии 3200-3300 Серии 5200-5300	Угол контакта от 32 до 35° с пазом	Отсутствует 3xxx	A	Без суффикса	Без суффикса	Без суффикса
	Угол контакта от 25 до 32° с пазом	3xxxS	B	B	A	B
	Полиамидный сепаратор	T2	G15	TVH / TVP	TN9	TNG
	Штампованный стальной сепаратор	Без суффикса	Без суффикса	Без суффикса	Без суффикса	J
	Одна или две штампованные защитные пластины	5xxxSCZZ	5000 ZZ	ZR / ZZR	Z / ZZ	Z / ZZ
	Одно или два контактных уплотнения	5xxxSCLLD/LLU	5000 EE	RSR / ZRSR	RS1 / ZRS1	DU / DDU
	Одно или два бесконтактных уплотнения	5xxxSCLLM	5000 EE	RSR / ZRSR	RS1 / ZRS1	V / VV
	Внутренний зазор (если отличается от нормального радиального зазора)	C2 / C3 и т.д.	J20 / J30 и т.д.	C2 / C3 и т.д.	C2 / C3 и т.д.	C2 / C3 и т.д.
Упорные шариковые однорядные подшипники двустороннего действия Серии 51100-51200-51300-51400	Штампованный стальной сепаратор	J	Без суффикса	Без суффикса	Без суффикса	Без суффикса
	Массивный латунный сепаратор			M, MP	Без суффикса	M
	Полиамидный сепаратор	T2				
Однорядные шариковые с 4-х точечным контактом Серии QJ2000 - QJ300	Полиамидный сепаратор		G15	TVP	TN, TN9	
	Массивный сепаратор	L1	MA	MPA	Без суффикса	M, MA
	Внутренний зазор (если отличается от нормального радиального зазора)	C2 / C3 и т.д.	J20 / J30 и т.д.	C2 / C3 и т.д.	C2 / C3 и т.д.	C2 / C3 и т.д.
Цилиндрические роликовые однорядные Серии N, NU, NUP, NU / 200 - 300 - 400 Серии N, NU, NUP, NU / 1000 - 2200 - 2300	Полиамидный сепаратор	T2 или T2X	G15	TVP2	P	T
	Стальной сепаратор	Без суффикса	Без суффикса	Без суффикса	J	W
	Массивный сепаратор	G1, L1	M	M, M1	M	M
	Повышенная нагрузочная способность	E	E	E	EC	E
	Внутренний зазор (если отличается от нормального радиального зазора)	C2 / C3 и т.д.	J20 / J30 и т.д.	C2 / C3 и т.д.	C2 / C3 и т.д.	C2 / C3 и т.д.
Цилиндрические роликовые двухрядные Серии NN, NNU, ...	Внутренний зазор для сдвоенных колец	C1NA, CONA и т.д.				
Однорядные конические роликоподшипники Серии 30200/300-31300 32000/200/300	Стальной сепаратор	Без суффикса	Без суффикса	Без суффикса	Без суффикса	Без суффикса
	Повышенная нагрузочная способность	Префикс 4T, ET	A, V	Без суффикса	Без суффикса	Префикс HR
	Полиамидный сепаратор	T2				
Сферические роликоподшипники Серия 21300 22200 - 22300 23000 - 23100 Серия 23200 - 23900 24000 - 24100	Полиамидный сепаратор	T2	EG15	TVPB		-
	Штампованный стальной сепаратор		EA	Без суффикса	C, CC, EC, ECC, E	C, CD, EA
	Массивный латунный сепаратор	L1	EM, MB	M, MA, MB	CA, CAC, ECA, ECAC	M
	Повышенная нагрузочная способность	Ultage	E, Ultage	E1, X-life	E, Explorer	HPS
	Внутренний зазор (если отличается от нормального радиального зазора)	C2 / C3 и т.д.	C2 / C3 и т.д.	C2 / C3 и т.д.	C2 / C3 и т.д.	C2 / C3 и т.д.
	Коническое отверстие/конусность 1:12	K	K	K	K	K
	Коническое отверстие/конусность 1:30	K30	K30	K30	K30	K30
	Смазочная канавка и смазочные отверстия	D1	W33	Без суффикса, S	Без суффикса	E4
	Стабилизирующая термообработка	TS	Без суффикса	Без суффикса	Без суффикса	Без суффикса, S11
	Исполнение для вибротехники/грохотов	UAVS1, UAVS2	F800, F801	T41A, T41D	VA005	U15VS
Упорно-радиальные однорядные сферические роликоподшипники Серии 29300-29400	Штампованный стальной сепаратор			Без суффикса	Без суффикса	Без суффикса
	Массивный латунный сепаратор	Без суффикса		MB	Без суффикса	M
	Повышенная нагрузочная способность		E	E	E	E

Подшипниковые самоустанавливающиеся узлы из серого чугуна

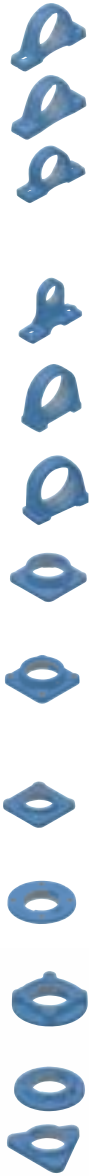
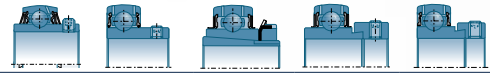
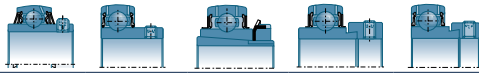

SNR	UCPE	USPE	UKPE..H	EXPE	ESPE
INA	RASEY	PASEY	-	RASE..N	PASE..N
SKF	SY..TF	-	SYJ..KF	SY..WF	SY..FM
RHP	NP	NP..A	NP10...K	NP..DEC	NP..EC
SNR	UCPLE	USPLE	UKPLE..H	EXPLE	ESPLE
RHP	SL	-	-	-	SL..EC
NTN	UCP..D1*	ASP	UKP..D1,H23..X*	UEL..D1W3**	AELP..D1
SNR	UCP**	USP	UKP..H**	EXP**	ESP
NSK	UCP	-	UKP..+H23..	EWP	EMP
ASAHI	UCP	-	UKP..+H23..	-	-
INA	RASEY - JIS	-	-	-	-
KOYO/TEKT	UCP	-	UKP	NAP..M	SAP..M
NTN	UCHP..D1	-	-	UELHP..D1W3	-
SNR	UCPH	USPH	UKPH..H	EXPH	ESPH
NSK	UCPH	-	UKPH..+H23..	-	-
ASAHI	UCPH	-	-	-	-
KOYO/TEKT	UCPH	-	-	-	-
SNR	UCPAE	USPAE	UKPAE..H	EXPAE	ESPAE
INA	RSHEY	PSHEY	-	RSHE..N	PSHE..N
SKF	SVF..TF	-	-	SVF..FM	-
RHP	SNP	SNP..A	-	SNP..DEC	SNP..EC
NTN	UCUP..D1	ASUP..	UKUP..D1,H23..X	UELUP..D1W3	AELUP..D1
SNR	UCPA/UCPG	USPA/USPG	UKPA..H/UKPG..H	EXPA/EXPG	ESPA/ESPG
NSK	UCPA	UBPA	-	EWPA	-
ASAHI	UCPA	-	-	-	-
KOYO/TEKT	UCPA	-	-	-	-
SNR	UCFE	USFE	UKFE..H	EXFE	ESFE
INA	RCJY	PCJY	-	RCJ..N	PCJ..N
SKF	FY..TF	-	FYJ..KF	FY..WF	FY..FM
RHP	SF	SF..A	MSF..K	SF..DEC	SF..EC
NTN	UCF..D1*	ASF..D1	UKF..D1,H23..X*	UEL..D1W3**	AELF..D1
SNR	UCF**	USF	UKF..H**	EXP**	ESF
NSK	UCF	-	UKF..H23..	EFW	-
ASAHI	UCF	-	UKF..H23..	-	-
INA	RCJY..JIS	-	-	-	-
KOYO/TEKT	UCF	-	UKF	-	SAF..FM
NTN	UCFS..D1	-	UKFS..D1,H23..X	UELFS..D1W3	-
SNR	UCFS	-	UKFS..H	EXFS	-
NSK	UCFS	-	UKFS..H23..	-	-
ASAHI	UCFS	-	-	-	-
KOYO/TEKT	UCFS	-	UKFS	-	-
SNR	UCFCE	USFCE	UKFCE..H	EXFCE	ESFCE
INA	RMEY	PMEY	-	RME	PME
RHP	FC	FC..A	-	FC..DEC	FC..EC
NTN	UCFC..D1***	ASFC..D1	UKFC..D1,H23..X***	UELFC..D1W3	AELFC..D1
SNR	UCFC	USFC	UKFC..H	EXFC	ESFC
SKF	FYC..TF	-	FYC..WF	FYC..FM	-
NSK	UCFC	-	UKFC..+H23..	EWFC	-
ASAHI	UCFC	-	UKFC..+H	-	KHFC
KOYO/TEKT	UCFC	-	UKFC	-	-
SNR	-	USFEE	-	-	ESFEE
INA	-	-	-	RFE	-
SNR	-	USFTE	-	-	ESFTE
INA	-	-	-	-	PCFTR

SNR	UCFLE	USFLE	UKFLE..H	EXFLE	ESFLE
INA	RCJTY	PCJTY	-	RCJTY..N	PCJTY..N
SKF	FYTB..TF	-	FYTD..KF	FYTB..WF	FYTB..FM
RHP	SFT	SFT..A	MSFT..K	SFT..DEC	SFT..EC
NTN	UCFL..D1*	ASFL..D1	UKFL..D1,H23..X*	UELFL..D1W3**	AELFL..D1
SNR	UCFL**	USFL	UKFL..H**	EXFL**	ESFL
NSK	UCFL	UBFL	UKFL..+H23..	EWFL	-
INA	RCJTY..JIS	-	-	-	-
ASAHI	UCFL	BFL	UKFL..+H	-	KHFL
KOYO/TEKT	UCFL	-	UKFL	-	SAFL..FM
SNR	UCFLZ	USFLZ	UKFLZ..H	EXFLZ	ESFLZ
INA	-	-	-	RCJTYZ	-
NTN	-	ASFLD..D1	-	-	AELFLD..D1
SNR	-	USFD	-	-	ESFD
INA	-	FLCTEY	-	-	GLCTE
NSK	-	UBFD	-	-	ENFD
ASAHI	-	BLCTE	-	-	ENFD
RHP	-	LFTCLA	-	-	LFTC..EC
SNR	-	USFAE	-	-	ESFAE
INA	-	-	-	-	PSFT
NTN	UCFA..D1	-	UKFA..D1,H23..X	-	AELFA..D1
SNR	UCFA	USFA	UKFA..H	EXFA	ESFA
NSK	UCFA	-	-	-	-
ASAHI	UCFA	-	-	-	-
KOYO/TEKT	UCFA	-	-	-	-
NTN	UCT..D1*	AST..D1	UKT..D1,H23..X*	UEL..D1W3**	AELT..D1
SNR	UCT**	UST	UKT..H**	EXT**	EST
INA	RTUEY	PTUEY	-	-	PTUE
SKF	TUL..TF	-	-	RTUE	TUL..FM
RHP	ST	ST..A	MSL..K	-	ST..EC
NSK	UCT	-	UKT..+H23..	ST..DEC	-
ASAHI	UCT	-	UKT..+H	EWT	KHT
KOYO/TEKT	UCT	-	UKT	-	-
NTN	UCT..-D1	UKT..-D1	-	-	-
SNR	UCT..+WB	UST..+WB	UKT..H..+WB	EXT..+WB	EST..+WB
NSK	UCT..+WB	-	-	-	-
ASAHI	UCT..+WB	-	-	-	-
NTN	-	ASPT2..-10	-	-	AELPT2..-10
SNR	UCSP	USSP	UKSP..H	EXSP	ESSP
RHP	BT	BT..A	-	-	BT..EC
SNR	SPR1	SPR11&21	SPR12&22	SPR14&24	-
RHP	BT	HUSE..	-	-	-
NTN	UCHB..D1	-	-	-	-
SNR	UCHE	USEHE	UKEHE..H	EXEHE	ESEHE
RHP	SCH	-	-	-	-
INA	-	PHEY	-	RHE	PHE
NSK	UCCH	-	-	-	-
ASAHI	UCCH	-	-	-	-
NTN	UCC..D1	ASC..	UKC..D1,H23..X*	UEL..D1W3**	AELC..D1
SNR	UCC	USC	UKC..H**	EXC**	ESC
NSK	UCC	-	UKC..+H23..	-	-
ASAHI	UCC	-	-	-	-
KOYO/TEKT	UCC	-	UKC	-	-

*Есть также в серии 300 и X (средний размер) / **Есть также в серии 300 / ***Есть также в серии X (средний размер) (1) Для SP есть 4 варианта корпуса

Специальные подшипники Корпусные подшипники

Квадратное, цилиндрическое и шестигранное отверстия



NTN	1AS... ⁽¹⁾	3SAS... ⁽¹⁾
NBCA	DC..	DS..
NSK-BSC	W2..PPB../GW2..PPB..	W2..PPB../GW2..PPB..
INA	GVK...KT-B / VK...KT-B (A.H.)	-
Fafnir	W2..PPB../GW2..PPB..	W2..PPB../GW2..PPB..

NTN	1AH... ⁽¹⁾	2AH... ⁽¹⁾
NBCA	HPC	HPS
NSK-BSC	..KRR..	..KRRB..
INA	-	SK...KRR-B
Fafnir	..KRR..	..KRRB..

NTN	1AC... ⁽¹⁾	3AC... ⁽¹⁾
NBCA	DC2..	DS2..
NSK-BSC	W2..PPB../GW2..PPB..	W2..PPB../GW2..PPB..
Fafnir	W2..PPB../GW2..PPB..	W2..PPB../GW2..PPB..

С цилиндрическим наружным кольцом



NTN	UCS2..D1**	UCS2..D1N	UELS2..D1**	UELS2..D1N	AELS2..NW3	AELS2..D1NW3	ASS2..N	ASS2..D1N
SNR	-	CUC2..	-	CEX2..	CES2..	-	CUS2..	-
RHP	-	UR2..	ENR2..	-	13...EC	13...ECG	13...-	-
RHP	11...-	11...CG	11...DEC	11...DECG	-	-	-	-
KOYO/TEKT	RB..	ER..	-	-	-	-	-	-
ASAHI	-	SER2..	-	-	KHR2..	-	-	-
INA	-	-	E..KRR	-	RAE..NPP NR	-	-	-

** - есть также в серии 300

Температуры

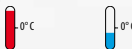

NTN	..HT2	..CT1
SNR	..T20	..T04
INA	..FA164.1	..FA101T
SKF	..VA201	..VA201
ASAHI	..HR 5	..CR 2A
RHP	..HLT	..HLT
NSK	..HT2	..CT1

Уплотнения



NTN	..LLJ	..L4
SNR	..L3	-
INA	..KPP(B)-3	-
SKF	-	..2RF
ASAHI	-	-
RHP	T...-	FS
NSK	..LLJ	-
KOYO/TEKT	..L3	-

(1) Для SP есть 4 варианта корпуса

Подшипниковые самоустанавливающиеся узлы

Нержавеющая сталь



NTN	F-UCPM...	-
SNR	SUCP	SESP
ASAHI	MUCP	-
DODGE	P2B-SCEZ	-
NTN	F-UCFM...LP03	-
SNR	SUCFL	SESL
ASAHI	MUCFL	-
DODGE	F2B-SCEZ	-
SNR	SUCPA	SESPA
ASAHI	MUCPA	-



SNR	SUCF	SESF
ASAHI	MUCF	-
DODGE	F4B-SCEZ	-
SNR	SUCT	SEST
ASAHI	MUCT	-

Подшипниковые самоустанавливающиеся узлы

Термопластик



NTN	F-UCPR2...**	-
SNR	GNP	-
SKF	SYK...TH/GFA	-
INA	RASEY...TN VA	-
RHP	PNP...CR	-
NTN	F-UCFR2...LP03*	-
SNR	GSF	-
SKF	FYK...TH/GFA	-
INA	RCJY...TN VA	-
RHP	PSF...CR	-



NTN	F-UCFLR2...LP03**	-
SNR	GSFT	-
SKF	FYTBK...TH/GFA	-
INA	RCJTY...TN VA	-
RHP	PSFT...CR	-

*: чёрный
**: белый или чёрный

Подшипниковые самоустанавливающиеся узлы

Листовая сталь

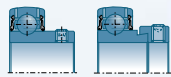
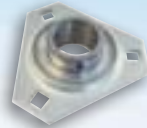

NTN	ASPP	AELPP..W3
SNR	USPP	ESPP
INA	PBY	PB
SKF	P..RM	P..FM
RHP	-	LPB..EC
ASAHI	BPP...Z2	KNPP...Z2
KOYO/JTEKT	SBPP	SAPP..FM
SNR	USPFT	ESPFT
INA	RATRY	RATR
SKF	PF..RM	PF..FM
RHP	SLFT..A	SLFT..EC
ASAHI	BPFT	-

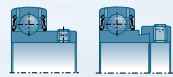

NTN	ASPFL	AELPFL
SNR	USPFL	ESPFL
INA	RATY	RAT
SKF	PFT..RM	PFT..FM
RHP	SLFL..A	SLFL..EC
NSK	UBPFL	ENPFL
ASAHI	BPFL	KNPFL
KOYO/JTEKT	SBPFL	SAPP..FM
SNR	USPFE	ESPFE
INA	-	MSTU
NTN	ASPF	AELPF..W3
SNR	USPF	ESPF
INA	RAY	RA
SKF	PF..RM	PF..FM
RHP	SLFE..A	SLFE..EC
NSK	UBPF	ENPF
ASAHI	PBF	KNPF
KOYO/JTEKT	SBPF	SAPP..FM

Торцевые крышки



Материалы		NTN	SNR	KOYO/JTEKT	ASAHI	RHP	INA	SKF
Стальная крышка (нерж.)	Закрытая	SM-	SCC./SCCE.	D..	E	-	-	-
	Открытая	S-	SCO./SCOE.	C	C	-	-	-
Чугунная крышка	Закрытая	CM-	-	FD	C	-	-	-
	Открытая	C-	-	FC	CE	-	-	-
Крышка штампованная	Закрытая	-	PCC..	-	-	..P	KASK	ECY..
	Открытая	-	PCO..	-	-	-	-	-
Крышка из термопласта	Закрытая	RM	CF..	-	-	-	-	ECL..
	Открытая	R	CV..	-	-	-	-	ECYB..

Крышки для корпусов из
A: чугун — нерж. сталь/B: чугун/C: чугун/D: термопласт

Корпусные подшипники



	Серии 200	Серии 300	Серии X
NTN	UC2..D1	UC3..D1	UCX..D1
SNR	UC2..G2	UC3..G2	-
INA	GYE..KRRB / GYE..KRRB-FA107	-	-
SKF	YAR2..2F	-	-
RHP	10..G	-	10...G
NSK	UC2...D1	UC2...D1	UC2...D1
ASAHI	UC2	UC3	UCX
KOYO/JTEKT	UC2	UC3	UCX
NTN	UEL2..D1W3	UEL3..D1W3	-
SNR	EX2..G2	EX3..G2	-
INA	GE..KRRB	-	-
SKF	YEL2..2F	-	-
RHP	10..DECG	-	-
NSK	EW2	-	-
ASAHI	UC2..+ER	-	-
KOYO/JTEKT	NA2	-	-
NTN	UK2..D1, H23..X	UK3..D1, H23..X	UKX...H23..X
SNR	UK2..G2H	UK3..G2H	-
SKF	YSA2...2FK, H23	-	-
RHP	10..KG, H3	-	-
NSK	UK2...+H23	UK3...H23	UKX...H23
ASAHI	UK2...+H23	UK3	UKX
KOYO/JTEKT	UK2...H23..X	UK3...H23..X	UKX...H23X
NTN	AS2	-	-
SNR	US2..G2	-	-
INA	GAY..NPPB	-	-
SKF	YAT2	-	-
RHP	12..G	-	-
NSK	AS2	-	-
ASAHI	B	-	-
KOYO/JTEKT	SB2	-	-
NTN	AEL2..W3D1	-	-
SNR	ES2..G2	-	-
INA	GRAE..NPPB	-	-
SKF	YET2	-	-
RHP	12..ECG	-	-
NSK	AEL2..W3D1	-	-
ASAHI	KH2..AE	-	-
KOYO/JTEKT	SA2	-	-
NTN	F-UC2..D1	-	-
SNR	SUC2	-	-
DODGE	SCEZ	-	-
ASAHI	MUC2	-	-
KOYO/JTEKT	UC2..S6	-	-
NTN	-	-	-
SNR	SES2	-	-
ASAHI	-	-	-
DODGE	-	-	-
NTN	F-UC2..D1	-	-
SNR	MUC2..FD	-	-
SKF	YAR2...2RF/HVGFA	-	-
INA	GYE..KRRB VA	-	-
RHP	J10...GCR	-	-
NTN	CS2..LLU	-	-
SNR	62..SEE	-	-
INA	2..NPPB	-	-
SKF	17262..2RS1	-	-
RHP	17262..2RS1	-	-
NSK	CS2..LLU	-	-
KOYO/JTEKT	CB2	-	-
FAG	762..2RSR	-	-

	Корпусной подшипник, резиновое кольцо	Корпусной подшипник	Резиновое кольцо
SNR	ESR2..B	ES2..SRS	SRB2
INA	RABR-B	RAE..NPPB	RABR
SKF	-	YET	RIS
NSK	-	AEL	T2066
SNR	CESR2..A	CES2..SRS	SRCA2
INA	RCSM-B	RAE..NPP	RCSM

- ▲ Адаптирован для корпуса из нерж. стали
- Адаптирован для корпуса из чугуна
- ✗ Адаптирован для штампованного корпуса
- Адаптирован для корпуса из термопласта

В таблице представлена информация о сопоставимых корпусах. Точная взаимозаменяемость по размерам не гарантирована.

Игольчатые подшипники



	NTN	INA	IKO	TORRINGTON	NADELLA	KOYO	SKF	Mc GILL	
мм	NK (Fw < 14 mm)	NK	TAF	NK	NB	NQ	NK	-	
	NK...R	-	-	-	-	-	-	-	
	NK...T2	NK...TV	-	NK...TN	-	-	NK...TN	-	
	RNA48	RNA48	RNA48	RNA48	-	-	RNA48	-	
	RNA49 (Fw < 14 mm)	RNA49	RNA49	RNA49	RNA49	RNA49...R	RNA49	-	
	RNA49...R	-	-	-	-	-	-	-	
	RNA49...L	RNA49...RSR	RNA49...U	RNA49...RS	-	-	RNA49...RS	-	
	RNA49...LL	RNA49...2RSR	RNA49...UU	RNA49...2RS	-	-	RNA49...2RS	-	
	RNA59	-	-	-	-	RNA59	-	-	
	RNA69 (Fw < 14 mm)	RNA69 (Fw < 40 mm)	RNA69	RNA69	-	RNA69	RNA69	-	
	RNA69...R	RNA69...ZW	RNA69 (Fw <= 35 mm: Однорядный) (Fw > 35 mm: Двухрядный)	RNA69 (Fw < 40 mm: Однорядный) (Fw >= 40 mm: Двухрядный)	-	-	-	-	
	NKS	NKS	TR	NKS	-	NQ5	NKS	-	
	RPNA	RPNA	-	-	-	-	RPNA	-	
	NK+1R (Fw < 14 mm)	NKI	TAF1	NKJ	NBI	NQJ	NKI	-	
	NK...R+1R	-	-	-	-	-	-	-	
	NK...T2+1R	NKI...TV	-	NKJ...TN	-	-	NKI...TN	-	
	NA48	NA48	NA48	NA48	-	-	NA48	-	
	NA49 (d < 10 mm)	NA49	NA49	NA49	-	NA49, NA49...R	NA49	-	
	NA49...R	-	-	-	-	-	-	-	
	NA49...L	NA49...RSR	NA49...U	-	-	-	NA49...RS	-	
	NA49...LL	NA49...2RSR	NA49...UU	-	-	NA49...UU	NA49...2RS	-	
	NA59	-	-	-	-	NA59	-	-	
	NA69 (Fw < 10 mm)	NA69 (Fw < 32 mm)	NA69	NA69	-	NA69	NA69	-	
	NA69...R	NA69...ZW	NA69 (Fw <= 30 mm: Однорядный) (Fw > 30 mm: Двухрядный)	NA69 (Fw < 32 mm: Однорядный) (Fw >= 32 mm: Двухрядный)	-	-	-	-	
	NKS+1R	NKI5	TRI	NKJ5	-	NQJ5	NKI5	-	
	PNA	PNA	-	-	-	-	-	-	
	1R	IR	IRT	JR, JRZ	IM...P	IRM	IR	-	
	1R...D	IR...IS1	-	JR...JS1	-	-	IR...IS1	-	
	RNAO	RNAO	RNAF	RNAO	-	-	RNAO	-	
	RNAO...T2	RNAO...TV	RNAF...N	RNAO...TN	-	-	RNAO...TN	-	
	RNAO...ZW	RNAO...ZW-ASR1	RNAFW	-	-	-	-	-	
	NAO	NAO	NAF	NAO	-	-	NAO	-	
	NAO...T2	NAO...TV	-	NAO...TN	-	-	NAO...TN	-	
	NAO...ZW	NAO...ZW-ASR1	NAFW	-	-	-	-	-	
	дюйм	MR	NCS	BR	HJ	-	-	-	MR
		MR+MI	NCS+PI	BRI	HJ+IR	-	-	-	MR+MI
		MI	PI	IRB	IR	-	-	-	MI

Комбинированные игольчатые подшипники



	NTN	INA	IKO	TORRINGTON	NADELLA	KOYO	SKF	Mc GILL
мм	NKX	NKX	NAX	-	-	-	NKX	-
	NKX...Z	NKX...Z	NAX...Z	-	-	-	NKX...Z	-
	NKX+1R	NKX+1R	NAXI	-	-	-	-	-
	NKX...Z+1R	NKX...Z+1R	NAXI...Z	-	-	-	-	-
	NKIA59	NKIA59	NATA59	-	-	-	NKIA59	-
	NKIB59...R	NKIB59	NATB59	-	-	-	NKIB59	-
	NKXR	NKXR	-	-	-	-	-	-
	NKXR...Z	NKXR...Z	NBX...Z	NAXR...Z	-	-	NKXR...Z	-
	NKXR+1R	NKXR+1R	-	-	-	-	-	-
	NKXR...Z+1R	NKXR...Z+1R	NBXI...Z	-	-	-	-	-
	AXN	-	-	-	AXNB	-	-	-
	ARN	ZARN	-	-	ARNB	-	-	-



Сепараторы с иглами в сборе

	NTN	INA	IKO	TORRINGTON	NADELLA	KOYO	SKF	Mc GILL
мм	K	K	KT	K, K...F	B	R, RS	K	-
	K...T2	K...TV	KTN	K...TN	-	RFN	K...TN	-
	KMU	-	-	-	-	V, VS	-	-
	PK	KZK	KT...EG	K...BE, WK...BE	-	VS...P	-	-
	KBK	KBK	KTV...EG	K...SE	-	R...P, UR...P	-	-
	GPK, GK	-	-	-	MB	RFNU	-	-
	K...ZW	K...ZW	KTW	K...ZW	BB	WR, WRS	K...ZW	-
	дюйм	PCJ	C	-	WJ, WJC	-	-	-



Игольчатые втулки

	NTN	INA	IKO	TORRINGTON	NADELLA	KOYO	SKF	Mc GILL	
мм	HK, HK...F(M)	HK	TLA...Z	HK	HK, (DB)	BTM	HK	-	
	HK...T2	HK...TV	-	-	-	BFNM	HK...TN	-	
	HK...L	HK...RS	-	HK...RS	HK...E, (DB...E)	BTM...U	HK...RS	-	
	HK...LL	HK...2RS	TLA...UU	HK...2RS	-	BTM...UU	HK...2RS	-	
	HK...ZWD	HK...ZW	TLAW...Z	-	-	-	HK...ZW	-	
	HK...D	HK...A51	-	HK...A51	-	BTM...OH	-	-	
	HMK	-	TA...Z	-	-	BHTM	-	-	
	HMK...L	-	-	-	-	BHTM...U	-	-	
	HMK...LL	-	-	-	-	BHTM...UU	-	-	
	HMK...ZWD	-	TAW...Z	-	-	-	-	-	
	BK	BK	TLAM	BK	BK, (DBF)	MKM	BK	-	
	BK...T2	BK...TV	-	-	-	-	BK...TN	-	
	BK...L	BK...RS	-	BK...RS	-	MKM...U	BK...RS	-	
	BK...ZWD	BK...ZW	TLAMW	-	-	-	-	-	
	дюйм	DCL, DCL...T2	SCE, SCE...TV	BA...Z	J, JH	-	BT	-	-
		DCL...L	SCE...P	-	JT	-	-	-	-
		DCL...LL	SCE...PP	-	JTT	-	-	-	-
DCH		SCH	BHA...Z	JH	-	BHT	-	-	



Аксессуары

	NTN	INA	IKO	TORRINGTON	NADELLA	KOYO	SKF	Mc GILL
MM	F	NRB	F	NRO.B	AIG...BP	LF	RN...BF	-
	A	-	A	NRO	AIG...BR	LA	RN...B	-
	WR	WR	WR	-	-	-	SW	-
	BR	BR	AR	-	-	-	BR	-
	G	G	OS	-	ET	-	G	-
	GD	SD	DS	-	-	-	SD	-



Кулачковые ролики с осью

	NTN	INA	IKO	TORRINGTON	NADELLA	KOYO	SKF	Mc GILL	
MM	KR	KR (<22mm)	CF...R	KR	-	KM...R	KR	MCFR	
	KR...H	KR...SK (<22mm) KR (>= 22 mm)	CF...BR	KR...SK	-	-	KR...SK	MCFR...B	
	KRT	-	CF-RU1	-	-	-	-	-	
	KR...X	KR...X (<22mm)	CF	KR...DZ	-	KM	KR...X	MCFR...X	
	KR...XH	KR...SKX (<22mm) KR...X (>= 22 mm)	CF...B	-	-	-	-	MCFR...BX	
	KRT...X	-	-	-	-	-	-	-	
	KR...LL	KR...PP (<22mm)	CF...UUR	KR...ZRS	-	KM...UUR	KR...PP	MCFR...S	
	KR...LLH	KR...PPSK (<22mm) KR...PP (>= 22 mm)	CF...BUUR	-	-	-	KR...PPSK	MCFR...SB	
	KRT...LL	-	-	-	-	-	-	-	
	KR...XLL	KR...XPP (<22mm)	CF...UU	KR...DZ.ZRS	-	KM...UU	KR...PPX	MCFR...SX	
	KR...XLLH	KR...XPPSK (<22mm) KR...XPP (>= 22 mm)	CF...BUU	-	-	-	-	MCFR...SBX	
	KRT...XLL	-	-	-	-	-	-	-	
	KRV...H	KRV (>= 22 mm)	CF...VBR	-	-	-	KRV...SK	MCF...B	
	KRVT	-	-	-	-	-	-	-	
	KRV...XH	KRV...SKX (<22 mm) KRV...X (>= 22mm)	CF...VB	-	-	-	-	MCF...BX	
	KRVT...X	-	-	-	-	-	-	-	
	KRV	KRV (<22mm)	CF...VR	KRV	GC	CM...R	KRV	MCF	
	KRV...X	KRV...X (<22mm)	CF...V	KRV...DZ	GCL	CM	KRV...X	MCF...X	
	KRV...LL	KRV...PP (<22mm)	CF...VUUR	KRV...ZRS	GC...EE	CM...UUR	KRV...PP	MCF...S	
	KRV...LLH	KRV...PPSK (<22 mm) KRV...PP (>= 22mm)	CF...VBUUR	-	-	-	KRV...PPSK	MCF...SB	
	KRVT...LL	-	-	-	-	-	-	-	
	KRV...XLL	KRV...XPP (<22mm)	CF...VUU	KRV...DZ.ZRS	GCL...EE	CM...UU	KRV...PPX	MCF...SX	
	KRV...XLLH	KRV...XPPSK (<22 mm) KRV...XPP (>= 22mm)	CF...VBUU	-	-	-	-	MCF...SBX	
	KRVT...XLL	-	-	-	-	-	-	-	
	KRMV...XH	-	CF...V	-	GC	-	-	-	
	NUKR	-	NUCF...R	NUKR	-	DKM...R	NUKR	MCFD	
	NUKR...H	NUKR	-	NUKR...2.SK	-	-	-	-	
	NUKR...X	-	-	NUKR...DZ	-	-	-	-	
	NUKR...XH	NUKR...X	-	-	-	-	-	-	
	NUKRT	-	-	-	-	-	-	-	
	NUKRT...X	-	-	-	-	-	-	-	
	KRM...XH	-	CF...S	-	-	-	-	-	
	KRX	-	CF-SFU	-	-	-	-	-	
	KRU	-	CFES...R	-	-	-	-	-	
	KRU...X	-	CFES	-	-	-	-	-	
	KRU...LL	-	CFES...UUR	-	-	-	-	-	
	KRU...XLL	-	CFES...UU	-	-	-	-	-	
	KRVU	-	CFES...VR	-	-	-	-	-	
	KRVU...X	-	CFES...V	-	-	-	-	-	
	KRVU...LL	-	CFES...VUUR	-	-	-	-	-	
	KRVU...XLL	-	CFES...VUU	-	-	-	-	-	
	NUKRU	-	-	-	-	-	-	-	
	NUKRU...X	-	-	-	-	-	-	-	
	Дюйм	CR	-	CR...R	-	-	-	-	
		CR...X	-	CR	-	-	-	-	
		CR...H	-	CR...BR	-	-	-	-	
		CR...XH	-	CR...B	-	-	-	-	
		CR...LL	-	CR...UUR	-	-	-	-	
		CR...XLL	-	CR...UU	-	-	-	-	
		CR...LLH	-	CR...BUUR	-	-	-	-	
		CR...XLLH	-	CR...BUU	-	-	-	-	
		CRV	CF...Y	CR...VR	CRC	-	-	-	CCF
		CRV...X	CF	CR...V	CR	-	CR	-	CF
		CRV...H	-	CR...VBR	CRCB	-	-	-	CCF...B
		CRV...XH	-	CR...VB	CRB	-	-	-	CF...B
CRV...LL		CF...YPP	CR...VUUR	CRCV	-	-	-	CCF...S	
CRV...XLL		CF...PP	CR...VUU	CRS	-	-	-	CF...S	
CRV...LLH		-	CR...VBUUR	CRCVB	-	-	-	CCF...SB	
CRV...XLLH		-	CR...VBUU	CRCVB	-	-	-	CF...SB	



Упорные игольчатые и роликовые подшипники

	NTN	INA	IKO	TORRINGTON	NADELLA	KOYO	SKF	Mc GILL	
мм	AXK11	AXK	NTB	AXK	-	TP	AXK	-	
	K811	K811...M	AZK	K811...LPB	-	-	K811...M	-	
	K811...T2	K811...TV	-	K811...TVP	-	-	K811...TN	-	
	K812	K812...M	AZK	K812...LPB	-	-	K812...M	-	
	K812...T2	K812...TV	-	K812...TVP	-	-	K812...TN	-	
	K874	K874	-	-	-	-	-	-	
	K893	K893...M	-	-	-	-	K893...M	-	
	A511	A5	A5	A5	-	W	A5	-	
	WS811	WS811	WS	WS811	-	-	WS811	-	
	WS812	WS812	WS	WS812	-	-	WS812	-	
	WS874	WS874	-	-	-	-	-	-	
	WS893	WS893	-	-	-	-	WS893	-	
	GS811	GS811	GS	GS811	-	-	GS811	-	
	GS812	GS812	GS	GS812	-	-	GS812	-	
	GS874	GS874	-	-	-	-	-	-	
	GS893	GS893	-	-	-	-	GS893	-	
	811	811...M	AZ	811...LPB	-	-	811...M	-	
	811...T2	811...TV	-	811...TVP	-	-	811...TN	-	
	812	812...M	AZ	812...LPB	-	-	812...M	-	
	812...T2	812...TV	-	812...TVP	-	-	812...TN	-	
	874	874	-	-	-	-	-	-	
	893	893...M	-	-	-	-	893...M	-	
	дюйм	NTC	TC	-	NTA	-	-	-	-
		NWA	TWA	-	TRA	-	-	-	-
		NWB	TWB	-	TRB	-	-	-	-
		NWC	TWC	-	TRC	-	-	-	-
		NWD	TWD	-	TRD	-	-	-	-



Кулачковые ролики без оси

	NTN	INA	IKO	TORRINGTON	NADELLA	KOYO	SKF	Mc GILL	
мм	RNAB2	RSTO	RNAST...R	RSTO	-	-	RSTO	-	
	RNAB2...X	RSTO...X	RNAST	RSTO...DZ	-	-	RSTO...X	-	
	NAB2	STO	NAST...R	STO	-	-	STO	-	
	NAB2...X	STO...X	NAST	STO...DZ	-	-	STO...X	-	
	NABR	-	NAST...ZZR	-	-	CZM...R	NAST...ZZ	-	
	RNA22...LL	RNA22...2RSR	-	RNA22...2RS	-	-	RNA22...2RS	-	
	RNA22...XLL	RNA22...2RSRX	-	RNA22...2RS.DZ	-	-	RNA22...2RSX	-	
	NA22...LL	NA22...2RSR	-	NA22...2RS	-	-	NA22...2RS	-	
	NA22...XLL	NA22...2RSRX	-	NA22...2RS.DZ	-	-	NA22...2RSX	-	
	NATR	NATR	NART...R	NATR	-	CXM...R	NATR	MCYRR	
	NATR...X	NATR...X	NART	NATR...DZ	-	CXM	NATR...X	MCYRR...X	
	NATR...LL	NATR...PP	-	-	-	CXM...UUR	NATR...PP	MCYRR...S	
	NATR...XLL	NATR...PPX	-	-	-	CXM...UU	NATR...PPX	MCYRR...SX	
	NATV	NATV	NART...VR	-	FG	CYM...R	NATV	MCYR	
	NATV...X	NATV...X	-	-	FGL	CYM	NATV...X	MCYR...X	
	NATV...LL	NATV...PP	NART...VUUR	-	FG...EE	CYM...UUR	NATV...PP	MCYR...S	
	NATV...XLL	NATV...PPX	-	-	FGL...EE	CYM...UU	NATV...PPX	MCYR...SX	
	NUTR	NUTR	NURT...R	NUTR	FGU	DCZM...R	NUTR	MCYRD	
	NUTR...X	NUTR...X	NURT	NUTR...DZ	FGUL	-	NUTR...X	-	
	NUTW	-	-	-	-	-	-	-	
	NUTW...X	-	-	-	-	-	-	-	
	дюйм	NACV	RF...Y	CRY...VR	-	-	-	-	CCYR
		NACV...X	RF	CRY...V	YCR	-	-	-	CYR
		NACV...LL	RF...YPP	CRY...VUUR	-	-	-	-	CCYR...S
		NACV...XLL	RF...PP	CRY...VUU	YCRS	-	-	-	CYR...S

Префиксы NTN и SNR

Марка	Префиксы	Описание
NTN	AC	Подшипники с компенсацией теплового расширения
SNR	CH	Гибридный подшипник, стальные кольца, керамические шарики
NTN	E	Подшипники из цементированной стали
NTN	EA	Подшипники из стали с нитроцементацией
NTN	EC	Подшипники с компенсацией теплового расширения
NTN	EC1	Подшипники с компенсацией теплового расширения, версия для высоких температур
NTN	ECO	Конические роликовые подшипники с увеличенным сроком службы
NTN	ET	Конические роликовые подшипники из цементуемой стали
NTN	ETA	Конические роликовые подшипники из нитроцементуемой стали
NTN	F	Подшипники из нержавеющей стали
NTN	FL	Подшипники с буртиком на наружном кольце
NTN	HL	Поверхностное упрочнение
NTN	LH	Сферические роликовые подшипники с увеличенным сроком службы
NTN	M	Подшипники с поверхностным упрочнением
SNR	ML	Радиально-упорный прецизионный шариковый подшипник для высоких скоростей вращения
SNR	MLCH	Радиально-упорный прецизионный шариковый подшипник с керамическими шариками для высоких скоростей вращения
SNR	MLE	Радиально-упорный прецизионный шариковый подшипник для высоких скоростей вращения с двухсторонним бесконтактным уплотнением
SNR	MLECH	Радиально-упорный прецизионный шариковый подшипник с керамическими шариками для высоких скоростей вращения с двухсторонним бесконтактным уплотнением
NTN	MX-	Антикоррозионная обработка
NTN	N	Специальная сталь
NTN	TA	Подшипники из азотированной стали
NTN	TM	Подшипники из стали со специальной обработкой
NTN	TS	Подшипники для высоких рабочих температур
NTN	TS2	Стабилизирующая термическая обработка для рабочих температур выше 160 °C
NTN	TS3	Стабилизирующая термическая обработка для рабочих температур выше 200 °C
NTN	TS4	Стабилизирующая термическая обработка для рабочих температур выше 250 °C
NTN	4T	Конические роликовые подшипники из стали, упрочненной цементацией
NTN	SS	Подшипники с керамическими телами качения

Суффиксы NTN и SNR

Марка	Суффиксы	Описание
NTN	A	Модификация внутренней конструкции
SNR	A	Радиальные однорядные шариковые подшипники с повышенной нагрузочной способностью
SNR	A	Радиально-упорные однорядные шариковые подшипники с полиамидным сепаратором
SNR	A	Радиальные двухрядные шариковые подшипники, без паза, с полиамидным сепаратором
SNR	A	Радиально-упорные двухрядные шариковые подшипники без канавки, с полиамидным сепаратором
SNR	A	Уплотнение V-Ring версия A для корпусного подшипника SNC (опционно с уплотнением FS)
NTN	AD	Угол контакта 25°
SNR	A1	Одиночный радиально-упорный шарикоподшипник
NTN	B	Стандартное исполнение сферических роликовых подшипников
NTN	B	Угол контакта 40° для радиально-упорного шарикового подшипника
SNR	B	- 32° для радиально-упорных шариковых двухрядных подшипников
SNR	B	- 40° для радиально-упорных однорядных подшипников
SNR	B	- 20° для конических роликовых подшипников
SNR	BG	Радиально-упорные шариковые однорядные подшипники для установки в тандем без предварительного нагружения
NTN	B3, B5, B7	Точность согласно нормам ABEC 3, 5 или 7
NTN	C	Угол контакта 15° для радиально-упорного шарикового подшипника
NTN	C	Увеличенный угол контакта для конических роликовых подшипников
NTN	C9, C0, C1	Специальные зазоры высокой точности
NTN / SNR	C2	Внутренний зазор меньше, чем нормальный зазор
NTN / SNR	C3	Внутренний зазор больше, чем нормальный зазор
NTN / SNR	C4	Внутренний зазор больше C3
NTN / SNR	C5	Внутренний зазор больше C4
NTN	CMxx	Средний зазор в микронах для шариковых подшипников диаметром от 10 до 50 мм
NTN	CM09	специальный внутренний зазор, среднее значение от 5 до 13 мкм
NTN	CM13	специальный внутренний зазор, среднее значение от 9 до 17 мкм
NTN	CM17	специальный внутренний зазор, среднее значение от 13 до 21 мкм
NTN	CM21	специальный внутренний зазор, среднее значение от 17 до 25 мкм
NTN	CM25	специальный внутренний зазор, среднее значение от 21 до 29 мкм
NTN	CM30	специальный внутренний зазор, среднее значение от 25 до 35 мкм
NTN	CM35	специальный внутренний зазор, среднее значение от 30 до 40 мкм
NTN	CM40	специальный внутренний зазор, среднее значение от 35 до 45 мкм
NTN	CM45	специальный внутренний зазор, среднее значение от 40 до 50 мкм
NTN	CM50	специальный внутренний зазор, среднее значение от 45 до 55 мкм
NTN	CSxx	Средний внутренний зазор в микронах (1 микрон = 1 мкм = 0,001 мм)
NTN	CT1	Корпусной подшипник для низких температур: -60 °C
NTN	CxNA	Уменьшенные допуски на зазор (но средний зазор идентичен), сдвоенные кольца
NTN	CNL, CNS	Внутренние зазоры для миниатюрных прецизионных подшипников
SNR	C/C12	Тип внутренней конструкции конических роликовых подшипников
SNR	CC	Закрытая торцевая крышка из нержавеющей стали для корпусных самоустанавливающихся подшипников
SNR	CO	Открытая торцевая крышка из нержавеющей стали для корпусных самоустанавливающихся подшипников
NTN	D	Увеличенный угол контакта для конических роликовых подшипников
NTN	D	Смазочные отверстия (без канавок)
SNR	D	Радиально-упорные прецизионные шариковые подшипники, смазываемые
NTN	DB	Установка по схеме O
NTN	DF	Установка по схеме X
SNR	D**	Смазки SNR
SNR	DS	Двуххромочное уплотнение корпуса подшипника SNC

Марка	Суффиксы	Описание
NTN	DT	Установка в тандем
NTN	D0	Отсутствие канавки и смазочных отверстий (в стандартном исполнении)
NTN	D1	Канавка и смазочные отверстия на наружном кольце
NTN	D2	D1 + фиксирующий шарик на наружном кольце для корпусных подшипников
NTN / SNR	E	Повышенная нагрузочная способность для цилиндрических роликовых подшипников и для сферических роликовых подшипников
NTN / SNR	EA	Сферические роликовые подшипники повышенной нагрузочной способности со штампованным сепаратором
NTN / SNR	EM	Сферические роликовые подшипники повышенной нагрузочной способности с массивным сепаратором
SNR	EE/2RS	Двухстороннее уплотнение
SNR	EC	Торцевая крышка корпусов SNC
NTN	En	Специальная выпуклая форма роликов
NTN	F	Корпус подшипника со сплошным основанием и без отверстий. Например, SNS20F
NTN	F1	Корпус подшипника со сплошным основанием и с отверстиями. Например: UCP320F1
NTN	F2	Корпус подшипника без отверстий крепления. Например, UCP322F2
SNR	FD	Смазка пластичная пищевая
SNR	FS	Сальник войлочный для корпуса подшипника SNC
SNR	FT150	Подшипники с уплотнением для высоких температур до +150 °C
SNR	FT150ZZ	Подшипники с защитными пластинами для высоких температур до +150 °C
NTN	F1	Массивный стальной сепаратор
NTN	F3	Механически обработанный стальной сепаратор
SNR	F600	Подшипники для высоких температур для тележек загрузки печей
SNR	F604	Подшипники для высоких температур, смазываемые, с защитными пластинами, для тележек загрузки печей
SNR	F800	Сферический роликовый подшипник повышенной грузоподъемности для вибрирующих машин
NTN	-G	Внутреннее кольцо + ролики (+ сепаратор) для конических роликовых подшипников
NTN	#G	Наружное кольцо отдельно для конических роликовых подшипников
NTN	G	Универсальное исполнение
SNR	G	Стяжная втулка: модифицированная резьба в соответствии с ИСО 2982-1
NTN	G	Корпус с подшипником, не требующий стопорного кольца. Например, SD3130G
NTN	G(n)	Корпус подшипника со специальными отверстиями крепления (№ 1, 2, 3 и т. д.). Например, UCHB204G6
NTN	GD2	Два сдвоенных универсальных подшипника
NTN	GL GN GM GH	Предварительная нагрузка (малая, нормальная, средняя, высокая)
NTN	G1	Массивный латунный сепаратор
SNR	G2	Система повторного смазывания корпусных подшипников
SNR	G14	Полиамидный сепаратор
SNR	G15	Полиамидный сепаратор, армированный стекловолокном наполнителем
SNR	H	Стяжная втулка с элементами подачи масла (например, AH24T48H)
NTN	HT	Специальная внутренняя конструкция цилиндрических роликовых подшипников для восприятия осевых нагрузок
NTN	HT2	Подшипниковый узел для высоких температур: +200 °C
SNR	HT200	Подшипники с уплотнением для высоких температур до +200 °C
SNR	HT200ZZ	Подшипники с защитными стальными пластинами для высоких температур до +200 °C
SNR	HVZZ	Подшипники с защитными стальными пластинами для высокой скорости вращения до 700 000 N.Dm
NTN	J	Штампованный стальной сепаратор
NTN / SNR	K	Коническое отверстие 1/12
NTN / SNR	K30	Коническое отверстие 1/30
NTN	-L	Роликовый подшипник NUP без шайбы - буртика
NTN	#L	Шайба - буртик для роликового подшипника NUP
NTN	L1	Корпус подшипника со смазчиком и сливным отверстием. Например: SNS15L1Z
NTN	L5	Корпус подшипника с отверстием под смазчик и сливным отверстием
SNR	LA	Лабиринтное уплотнение для корпуса подшипника SNC
NTN	LLJ	Подшипниковый узел с трёхкромочным уплотнением с малым контактным давлением
NTN	LLS	Подшипниковый узел с трёхкромочным уплотнением с большим контактным давлением
SNR	LT	Подшипники с уплотнением для низких температур до -40 °C
SNR	LTZZ	Подшипники с защитными стальными пластинами для низких температур до -60 °C

Марка	Суффиксы	Описание
NTN	LU, LLU	Контактное нитрильное уплотнение (от -20 до +120 °C)
NTN	LUA, LLUA	Уплотнение полиакриловое контактное (от -15 до +150 °C)
NTN	LUA1, LLUA1	Уплотнение из фторкаучука контактное (от -30 до +230 °C)
NTN	LUA2, LLUA2	Уплотнение силиконовое контактное (от -60 до +200 °C)
NTN	LUA4, LLUA4	Уплотнение из высокомолекулярного нитрила контактное (от -20 до +140 °C)
NTN	LUAX12, LLUAX12	Контактное полиакриловое уплотнение (от -15 до +175 °C)
NTN	LB, LLB	Бесконтактное нитрильное уплотнение (от -25 до +120 °C)
NTN	LBA, LLBA	Бесконтактное полиакриловое уплотнение (от -10 до +150 °C)
NTN	LBA1, LLBA1	Бесконтактное уплотнение из фторированного эластомера (от -30 до +200 °C)
NTN	LBA2, LLBA2	Бесконтактное силиконовое уплотнение (от -100 до +200 °C)
NTN	LH, LLH	Контактное нитрильное уплотнение с низким моментом сопротивления (от -25 до +120 °C)
NTN	LHA, LLHA	Контактное полиакриловое уплотнение с низким моментом сопротивления (от -10 до +150 °C)
NTN	LHA1, LLHA1	Уплотнение из фторкаучука контактное с малым контактным давлением (от -30 до +220 °C)
NTN	LHA2, LLHA2	Уплотнение силиконовое контактное с малым контактным давлением (от -100 до +230 °C)
NTN	LHA4, LLHA4	Уплотнение из высокомолекулярного нитрила к с малым контактным давлением (от -20 до +130 °C)
NTN	LHAX12, LLHAX12	Уплотнение из высокомолекулярного полиакрила с малым контактным давлением (от -10 до +150 °C)
NTN	LP03	Смазка консистентная стандартная (от -20 до +80 °C)
NTN	LP05	Смазка консистентная высокотемпературная (от -20 до +120 °C)
NTN	LP06	Смазка консистентная пищевая от -10 до +100 °C (80 °C в постоянном режиме работы)
NTN	LP08	Смазка консистентная высокотемпературная для игольчатых подшипников (от -20 до +120 °C)
NTN	LX	Специальное уплотнение
NTN	L1	Массивный латунный клепанный сепаратор
SNR	L3	Трёхромбическое уплотнение для корпусных подшипников
NTN	L417	Смазка: Kyodo Yushi/ES (от -30 до +180 °C)
NTN	L453	Смазка: Klüber/Asonic HQ72-102 (от -40 до +180 °C)
NTN	L627	Смазка: Exxon/Polytex EM/Polytec (от -25 до +170 °C)
SNR	M	Массивный сепаратор, центрированный на телax качения
NTN	-N	Внутреннее кольцо + ролики (+ сепаратор) для цилиндрических роликовых подшипников
NTN	#N	Внутреннее кольцо отдельно для цилиндрических роликовых подшипников
NTN / SNR	N	Канавка для стопорного кольца на наружном кольце подшипника
NTN	N	Стальной подшипниковый узел. Например, P315N
NTN	N1	Чугунный подшипниковый узел GS. Например, P315N1
NTN / SNR	NR	Канавка и стопорное кольцо на наружном кольце подшипника
NTN	NRS	-NR с противоположной стороны от стандартного положения
NTN / SNR	N2	Фиксирующий паз на наружном кольце подшипника
NTN	PM	Специальная точность подшипников для электродвигателей
NTN / SNR	P42	Класс точности JIS 4 на размеры и JIS 2 на радиальное биение
NTN	P63E	Класс точности P6 и зазор C3/норма DIN на электродвигатели
NTN / SNR	P6	Класс точности JIS 6
NTN / SNR	P5	Класс точности JIS 5
NTN / SNR	P4	Класс точности JIS 4/BAS 4 для конических роликов
NTN	PK	Класс точности K для конических роликов, серия J
NTN / SNR	PXn	Специальные отклонения (в соответствии с чертежом)
NTN	QD	Заполнение смазкой: от 5 до 10%
NTN	QE	Заполнение смазкой: от 7,5 до 12,5%
NTN	QF	Заполнение смазкой: от 10 до 15%
NTN	QG	Заполнение смазкой: от 12,5 до 17,5%
NTN	QH	Заполнение смазкой: от 15 до 20%
NTN	QJ	Заполнение смазкой: от 17,5 до 22,5%
NTN	QK	Заполнение смазкой: от 20 до 25%
NTN	QL	Заполнение смазкой: от 22,5 до 27,5%
NTN	QM	Заполнение смазкой: от 25 до 30%
NTN	QP	Заполнение смазкой: от 27,5 до 32,5%

Марка	Суффиксы	Описание
NTN	QQ	Заполнение смазкой: от 30 до 40%
NTN	QR	Заполнение смазкой: от 35 до 45%
NTN	QS	Заполнение смазкой: от 40 до 50%
NTN	QT	Заполнение смазкой: более 50%
SNR	S	Наружный сферический диаметр
NTN	Snn	Специальный контроль (S20: Железнодорожный транспорт/S30: Ветровая энергетика)
NTN	ST	Модифицированная внутренняя конструкция (малый момент)
NTN	STVn	Модифицированная внутренняя конструкция (№ 1, 2, 3 и т. д.) (малый момент)
SNR	SV	Уплотнение V-Ring в комплекте для корпусного подшипника SNC
SNR	TA	Уплотнение Taconite для корпусного подшипника SNC
NTN	TKBAnnnn	Специальная распорная втулка. Nnnp: номер заказа
NTN	TKZnnnn	Специальная распорная втулка. Nnnp: номер заказа
NTN	TKBNnnnn	Специальная распорная втулка. Nnnp: номер заказа
NTN	T1	Текстолитовый сепаратор
NTN	T2	Сепаратор из пластика, нейлона или тефлона
NTN	T2X	Специальный полиамидный сепаратор для шариковых подшипников с уплотнением
NTN	T2X	Сепаратор из полиамида 4.6 для цилиндрических роликовых подшипников
NTN	T6	Сепаратор Peek для подшипников NN
SNR	T04	Корпусные подшипники для рабочих температур до -40 °C
SNR	T20	Корпусные подшипники для рабочих температур до +200 °C
NTN	U	Усиленная версия конических роликовых подшипников
NTN	UA	Сферический роликовый подшипник повышенной грузоподъемности для вибрирующих машин
NTN	UP	Сверхвысокая точность
SNR	V	Внутренняя конструкция сферических роликовых подшипников
NTN	V	Бессепараторные цилиндрические роликовые подшипники
NTN	Vn	Специальный: объединяет другие суффиксы (№ 1, 2, 3 и т. д.)
NTN	VS1, VS2	Специальный допуск для подшипников грохотов
NTN	W3	Корпусной подшипник с установочным винтом
NTN	W5	Корпусной подшипник с установочным винтом, который отличается от W3
NTN	W6	Корпусной подшипник с установочным винтом, который отличается от W5
SNR	W33	Канавка и смазочные отверстия на наружном кольце
NTN	Xn	Специальная фаска № 1, 2 и т. д.
SNR	Y	Штампованный латунный сепаратор для шариковых подшипников тонкого сечения
NTN	Z	Корпус подшипника с резиновым уплотнением типа Z
NTN / SNR	Z	Защитная пластина из листовой стали с одной стороны
NTN	ZZ	Корпус подшипника с войлочным уплотнением
NTN / SNR	ZZ	Защитная пластина из листовой стали с двух сторон
NTN	ZA, ZZA	Защитная пластина из листовой стали
NTN	Z1, ZZ1	Защитная пластина из нержавеющей стали
NTN	2AS	Смазка: Shell/Alvania Grease S2 (от -25 до +120 °C)
NTN	3AS	Смазка: Shell/Alvania Grease S3 (от -25 до +135 °C)
NTN	-3, -2, -0	Класс точности согласно нормам AFBMA для дюймовых конических роликовых подшипников
NTN	5C	Смазка: Chevron/SRI-2 (от -29 до +177 °C)
NTN	5K	Смазка: Kyodo Yushi/Multemp SRL (от -40 до +150 °C)
NTN	5S	Смазка: Shell/Aero Shell Grease 7 (от -73 до +149 °C)
NTN	6K	Смазка: Kluber/Isoflex Super LDS 18 (от -60 до +130 °C)



Руководство для пользователя

Графические символы на перечнях продуктов



Обозначения подшипников

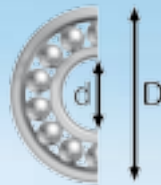

Отверстие: d
Наружный диаметр: D
Размеры в мм

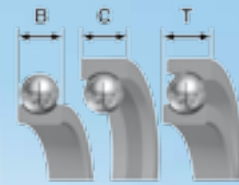

Ширина:
Внутреннее кольцо: B
Наружное кольцо: C
Общая: T
Размеры в мм

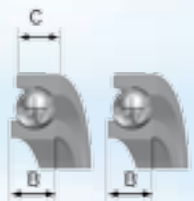

Ширина:
Внутреннее кольцо: B
Наружное кольцо: C
Размеры в мм



Общая масса в кг



Обозначение
Номер рисунка направляет к изображениям на клапанах обложки

Несмотря на то что общий каталог разрабатывался скрупулезно, ошибки или упущения, которые могли остаться незамеченными, не накладывают никаких обязательств на компанию NTN-SNR ROULEMENTS.

Придерживаясь последовательной политики в области научных исследований и конструкторских разработок, производитель оставляет за собой право изменять целиком или частично продукты и технические характеристики, названные в настоящем документе, без предварительного уведомления.

Соответствия между обозначениями, указанные в этом документе, приведены в информационных целях. Для большей уверенности обратитесь к представителю NTN-SNR в вашем регионе.

NTN-SNR Copyright International 2013.

В настоящем документе представлена вся наша продукция серийного изготовления. Этот документ заменяет и аннулирует наши предыдущие каталоги продукции.

 Ball bearing

 Rillenkugellager

 Rodamientos de bolas

 Шарикоподшипники

 Roulements à billes

 Cuscinetti a sfera

 Rolamentos de esferas

 Łożyska kulkowe



Classification by references – Classification par références
Klassifizierung nach Referenzen – Classificazione per codice
Clasificación por referencias – Classificação por referências
Классификация по кодам – Klasyfikacja wg numerów katalogowych



Reference	d	D	B	Kg		Brands
11204G15	20,000	47,000	14 / 40	0,18	6	SNR
11205G15	25,000	52,000	15 / 44	0,22	6	SNR
11206G15	30,000	62,000	16 / 48	0,35	6	SNR
11207G15	35,000	72,000	17 / 52	0,54	6	SNR
11208G15	40,000	80,000	18 / 56	0,72	6	SNR
11209G15	45,000	85,000	19 / 58	0,79	6	SNR
11210G15	50,000	90,000	20 / 58	0,85	6	SNR
11211G15	55,000	100,000	21 / 60	1,13	6	SNR
11212G15	60,000	110,000	22 / 62	1,51	6	SNR
11305G15	25,000	62,000	17 / 48	0,42	6	SNR
11306G15	30,000	72,000	19 / 52	0,60	6	SNR
11308G15	40,000	90,000	23 / 58	1,08	6	SNR
1200G15	10,000	30,000	9,000	0,03	6	SNR
1200S	10,000	30,000	9,000	0,03	6	NTN
1201G15	12,000	32,000	10,000	0,05	6	SNR
1201S	12,000	32,000	10,000	0,04	6	NTN
1202G15	15,000	35,000	11,000	0,05	6	SNR
1202S	15,000	35,000	11,000	0,05	6	NTN
1203G15	17,000	40,000	12,000	0,08	6	SNR
1203S	17,000	40,000	12,000	0,07	6	NTN
1204	20,000	47,000	14,000	0,12	6	SNR
1204S	20,000	47,000	14,000	0,12	6	NTN
1204SK	20,000	47,000	14,000	0,12	6	NTN
1205	25,000	52,000	15,000	0,15	6	SNR
1205K	25,000	52,000	15,000	0,13	6	SNR
1205S	25,000	52,000	15,000	0,14	6	NTN
1205SK	25,000	52,000	15,000	0,14	6	NTN
1206	30,000	62,000	16,000	0,23	6	SNR
1206G14	30,000	62,000	16,000	0,22	6	SNR
1206K	30,000	62,000	16,000	0,22	6	SNR
1206KG14	30,000	62,000	16,000	0,22	6	SNR
1206S	30,000	62,000	16,000	0,22	6	NTN
1206SK	30,000	62,000	16,000	0,22	6	NTN
1207	35,000	72,000	17,000	0,33	6	SNR
1207K	35,000	72,000	17,000	0,32	6	SNR
1207S	35,000	72,000	17,000	0,32	6	NTN
1207SK	35,000	72,000	17,000	0,32	6	NTN
1208	40,000	80,000	18,000	0,43	6	SNR
1208K	40,000	80,000	18,000	0,42	6	SNR
1208S	40,000	80,000	18,000	0,42	6	NTN
1208SK	40,000	80,000	18,000	0,42	6	NTN
1209	45,000	85,000	19,000	0,47	6	SNR
1209K	45,000	85,000	19,000	0,46	6	SNR
1209S	45,000	85,000	19,000	0,47	6	NTN
1209SK	45,000	85,000	19,000	0,47	6	NTN
1210	50,000	90,000	20,000	0,53	6	SNR
1210K	50,000	90,000	20,000	0,53	6	SNR
1210S	50,000	90,000	20,000	0,53	6	NTN
1210SK	50,000	90,000	20,000	0,53	6	NTN

Reference	d	D	B	Kg		Brands
1211	55,000	100,000	21,000	0,71	6	SNR
1211G15	55,000	100,000	21,000	0,70	6	SNR
1211K	55,000	100,000	21,000	0,69	6	SNR
1211S	55,000	100,000	21,000	0,71	6	NTN
1211SK	55,000	100,000	21,000	0,71	6	NTN
1212G15	60,000	110,000	22,000	0,89	6	SNR
1212KG15	60,000	110,000	22,000	0,89	6	SNR
1212S	60,000	110,000	22,000	0,90	6	NTN
1212SK	60,000	110,000	22,000	0,90	6	NTN
1213	65,000	120,000	23,000	1,13	6	SNR
1213K	65,000	120,000	23,000	1,12	6	SNR
1213S	65,000	120,000	23,000	1,15	6	NTN
1213SK	65,000	120,000	23,000	1,15	6	NTN
1214S	70,000	125,000	24,000	1,30	6	NTN
1215	75,000	130,000	25,000	1,38	6	SNR
1215K	75,000	130,000	25,000	1,37	6	SNR
1215S	75,000	130,000	25,000	1,41	6	NTN
1215SK	75,000	130,000	25,000	1,41	6	NTN
1216	80,000	140,000	26,000	1,65	6	SNR
1216K	80,000	140,000	26,000	1,63	6	SNR
1216S	80,000	140,000	26,000	1,73	6	NTN
1216SK	80,000	140,000	26,000	1,73	6	NTN
1217	85,000	150,000	28,000	2,16	6	SNR
1217K	85,000	150,000	28,000	2,09	6	SNR
1217S	85,000	150,000	28,000	2,09	6	NTN
1217SK	85,000	150,000	28,000	2,09	6	NTN
1218	90,000	160,000	30,000	2,55	6	SNR
1218K	90,000	160,000	30,000	2,56	6	SNR
1218S	90,000	160,000	30,000	2,55	6	NTN
1218SK	90,000	160,000	30,000	2,55	6	NTN
1219	95,000	170,000	32,000	3,16	6	SNR
1219K	95,000	170,000	32,000	3,12	6	SNR
1219S	95,000	170,000	32,000	3,21	6	NTN
1219SK	95,000	170,000	32,000	3,21	6	NTN
1220	100,000	180,000	34,000	3,77	6	SNR
1220K	100,000	180,000	34,000	3,71	6	SNR
1220S	100,000	180,000	34,000	3,82	6	NTN
1220SK	100,000	180,000	34,000	3,82	6	NTN
1221S	105,000	190,000	36,000	4,52	6	NTN
1222	110,000	200,000	38,000	5,21	6	SNR
1222K	110,000	200,000	38,000	5,16	6	SNR
1222S	110,000	200,000	38,000	5,33	6	NTN
1222SK	110,000	200,000	38,000	5,33	6	NTN
1300S	10,000	35,000	11,000	0,06	6	NTN
1301G14	12,000	37,000	12,000	0,07	6	SNR
1301S	12,000	37,000	12,000	0,07	6	NTN
1302G14	15,000	42,000	13,000	0,10	6	SNR
1302S	15,000	42,000	13,000	0,09	6	NTN

Reference	d	D	B	Kg	Brands
1303G14	17,000	47,000	14,000	0,13	6 SNR
1303S	17,000	47,000	14,000	0,13	6 NTN
1304G15	20,000	52,000	15,000	0,16	6 SNR
1304S	20,000	52,000	15,000	0,15	6 NTN
1304SK	20,000	52,000	15,000	0,15	6 NTN
1305G15	25,000	62,000	17,000	0,25	6 SNR
1305KG15	25,000	62,000	17,000	0,26	6 SNR
1305S	25,000	62,000	17,000	0,26	6 NTN
1305SK	25,000	62,000	17,000	0,26	6 NTN
1306	30,000	72,000	19,000	0,40	6 SNR
1306K	30,000	72,000	19,000	0,40	6 SNR
1306S	30,000	72,000	19,000	0,39	6 NTN
1306SK	30,000	72,000	19,000	0,39	6 NTN
1307G15	35,000	80,000	21,000	0,50	6 SNR
1307KG15	35,000	80,000	21,000	0,50	6 SNR
1307S	35,000	80,000	21,000	0,51	6 NTN
1307SK	35,000	80,000	21,000	0,51	6 NTN
1308	40,000	90,000	23,000	0,72	6 SNR
1308K	40,000	90,000	23,000	0,72	6 SNR
1308S	40,000	90,000	23,000	0,72	6 NTN
1308SK	40,000	90,000	23,000	0,72	6 NTN
1309	45,000	100,000	25,000	0,98	6 SNR
1309K	45,000	100,000	25,000	0,97	6 SNR
1309S	45,000	100,000	25,000	0,96	6 NTN
1309SK	45,000	100,000	25,000	0,96	6 NTN
1310G15	50,000	110,000	27,000	1,23	6 SNR
1310KG15	50,000	110,000	27,000	1,22	6 SNR
1310S	50,000	110,000	27,000	1,25	6 NTN
1310SK	50,000	110,000	27,000	1,25	6 NTN
1311G15	55,000	120,000	29,000	1,64	6 SNR
1311KG15	55,000	120,000	29,000	1,54	6 SNR
1311S	55,000	120,000	29,000	1,60	6 NTN
1311SK	55,000	120,000	29,000	1,60	6 NTN
1312	60,000	130,000	31,000	2,01	6 SNR
1312K	60,000	130,000	31,000	1,99	6 SNR
1312S	60,000	130,000	31,000	2,03	6 NTN
1312SK	60,000	130,000	31,000	2,03	6 NTN
1313S	65,000	140,000	33,000	2,54	6 NTN
1313SK	65,000	140,000	33,000	2,54	6 NTN
1314S	70,000	150,000	35,000	3,19	6 NTN
1315	75,000	160,000	37,000	3,64	6 SNR
1315K	75,000	160,000	37,000	3,58	6 SNR
1315S	75,000	160,000	37,000	3,65	6 NTN
1315SK	75,000	160,000	37,000	3,65	6 NTN
1316S	80,000	170,000	39,000	4,31	6 NTN
1316SK	80,000	170,000	39,000	4,31	6 NTN
1317	85,000	180,000	41,000	5,05	6 SNR
1317K	85,000	180,000	41,000	4,85	6 SNR

Reference	d	D	B	Kg	Brands
1317S	85,000	180,000	41,000	5,13	6 NTN
1317SK	85,000	180,000	41,000	5,13	6 NTN
1318S	90,000	190,000	43,000	5,94	6 NTN
1318SK	90,000	190,000	43,000	5,94	6 NTN
1319S	95,000	200,000	45,000	6,84	6 NTN
1319SK	95,000	200,000	45,000	6,84	6 NTN
1320	100,000	215,000	47,000	8,70	6 SNR
1320K	100,000	215,000	47,000	8,30	6 SNR
1320S	100,000	215,000	47,000	8,46	6 NTN
1320SK	100,000	215,000	47,000	8,46	6 NTN
1321S	105,000	225,000	49,000	10,00	6 NTN
1322S	110,000	240,000	50,000	12,00	6 NTN
1322SK	110,000	240,000	50,000	12,00	6 NTN
16001	12,000	28,000	7,000	0,02	1 NTN
16002	15,000	32,000	8,000	0,03	1 NTN-SNR
16003	17,000	35,000	8,000	0,03	1 NTN-SNR
16003/16	16,000	35,000	8,000	0,03	1 NTN
16004	20,000	42,000	8,000	0,05	1 NTN-SNR
16004/22	22,000	42,000	8,000	0,04	1 NTN
16005	25,000	47,000	8,000	0,06	1 NTN-SNR
16005/50	25,000	50,000	8,000	0,07	1 NTN
16006	30,000	55,000	9,000	0,09	1 NTN-SNR
16007	35,000	62,000	9,000	0,11	1 NTN-SNR
16007/36	36,000	62,000	9,000	0,11	1 NTN
16008	40,000	68,000	9,000	0,13	1 NTN-SNR
16009	45,000	75,000	10,000	0,17	1 NTN-SNR
16010	50,000	80,000	10,000	0,18	1 NTN-SNR
16011	55,000	90,000	11,000	0,25	1 NTN-SNR
16012	60,000	95,000	11,000	0,28	1 NTN-SNR
16013	65,000	100,000	11,000	0,29	1 NTN-SNR
16014	70,000	110,000	13,000	0,44	1 NTN-SNR
16015	75,000	115,000	13,000	0,47	1 NTN-SNR
16016	80,000	125,000	14,000	0,60	1 NTN-SNR
16017	85,000	130,000	14,000	0,66	1 NTN-SNR
16018	90,000	140,000	16,000	0,85	1 NTN-SNR
16019	95,000	145,000	16,000	0,92	1 NTN
16020	100,000	150,000	16,000	0,91	1 NTN-SNR
16021	105,000	160,000	18,000	1,23	1 NTN
16022	110,000	170,000	19,000	1,46	1 NTN-SNR
16024	120,000	180,000	19,000	1,58	1 NTN-SNR
16024N	120,000	180,000	19,000	1,42	1-MR NTN
16026	130,000	200,000	22,000	2,31	1 NTN-SNR
16028	140,000	210,000	22,000	2,48	1 NTN-SNR
16030	150,000	225,000	24,000	3,07	1 NTN
16032	160,000	240,000	25,000	3,73	1 NTN-SNR
16034	170,000	260,000	28,000	4,93	1 NTN-SNR



Reference	d	D	B	Kg		Brands
16038	190,000	290,000	31,000	6,77	1	NTN-SNR
16040	200,000	310,000	34,000	9,03	1	NTN-SNR
16044	220,000	340,000	37,000	11,30	1	NTN
16048	240,000	360,000	37,000	14,10	1	NTN
16052	260,000	400,000	44,000	18,50	1	NTN
16056	280,000	420,000	44,000	23,90	1	NTN
16060	300,000	460,000	50,000	32,50	1	NTN
16064	320,000	480,000	50,000	34,20	1	NTN
16068	340,000	520,000	57,000	47,10	1	NTN
16072	360,000	540,000	57,000	49,30	1	NTN
16076	380,000	560,000	57,000	50,10	1	NTN
16080	400,000	600,000	63,000	65,80	1	NTN
16101	12,000	30,000	8,000	0,03	1	NTN
2200G14	10,000	30,000	14,000	0,05	6	SNR
2200S	10,000	30,000	14,000	0,04	6	NTN
2201EEG15	12,000	32,000	14,000	0,06	6	SNR
2201G15	12,000	32,000	14,000	0,05	6	SNR
2201S	12,000	32,000	14,000	0,05	6	NTN
2202EEG15	15,000	35,000	14,000	0,06	6	SNR
2202G15	15,000	35,000	14,000	0,06	6	SNR
2202S	15,000	35,000	14,000	0,06	6	NTN
2203EEG15	17,000	40,000	16,000	0,10	6	SNR
2203G15	17,000	40,000	16,000	0,09	6	SNR
2203S	17,000	40,000	16,000	0,09	6	NTN
2204EEG15	20,000	47,000	18,000	0,15	6	SNR
2204G15	20,000	47,000	18,000	0,14	6	SNR
2204KEEG15	20,000	47,000	18,000	0,16	6	SNR
2204S	20,000	47,000	18,000	0,13	6	NTN
2204SK	20,000	47,000	18,000	0,13	6	NTN
2205	25,000	52,000	18,000	0,17	6	SNR
2205EEG15	25,000	52,000	18,000	0,16	6	SNR
2205G15	25,000	52,000	18,000	0,16	6	SNR
2205K	25,000	52,000	18,000	0,16	6	SNR
2205KEEG15	25,000	52,000	18,000	0,17	6	SNR
2205S	25,000	52,000	18,000	0,15	6	NTN
2205SK	25,000	52,000	18,000	0,15	6	NTN
2206	30,000	62,000	20,000	0,28	6	SNR
2206EEG15	30,000	62,000	20,000	0,27	6	SNR
2206K	30,000	62,000	20,000	0,26	6	SNR
2206KEEG15	30,000	62,000	20,000	0,28	6	SNR
2206S	30,000	62,000	20,000	0,25	6	NTN
2206SK	30,000	62,000	20,000	0,25	6	NTN
2207	35,000	72,000	23,000	0,41	6	SNR
2207EEG15	35,000	72,000	23,000	0,42	6	SNR
2207K	35,000	72,000	23,000	0,40	6	SNR
2207KEEG15	35,000	72,000	23,000	0,46	6	SNR
2207S	35,000	72,000	23,000	0,38	6	NTN
2207SK	35,000	72,000	23,000	0,38	6	NTN
2208EEG15	40,000	80,000	23,000	0,51	6	SNR
2208G15	40,000	80,000	23,000	0,48	6	SNR
2208KEEG15	40,000	80,000	23,000	0,50	6	SNR

Reference	d	D	B	Kg		Brands
2208K615	40,000	80,000	23,000	0,47	6	SNR
2208S	40,000	80,000	23,000	0,48	6	NTN
2208SK	40,000	80,000	23,000	0,48	6	NTN
2209	45,000	85,000	23,000	0,56	6	SNR
2209EEG15	45,000	85,000	23,000	0,54	6	SNR
2209K	45,000	85,000	23,000	0,55	6	SNR
2209KEEG15	45,000	85,000	23,000	0,53	6	SNR
2209S	45,000	85,000	23,000	0,52	6	NTN
2209SK	45,000	85,000	23,000	0,52	6	NTN
2210	50,000	90,000	23,000	0,61	6	SNR
2210EEG15	50,000	90,000	23,000	0,60	6	SNR
2210K	50,000	90,000	23,000	0,58	6	SNR
2210KEEG15	50,000	90,000	23,000	0,59	6	SNR
2210S	50,000	90,000	23,000	0,56	6	NTN
2210SK	50,000	90,000	23,000	0,56	6	NTN
2211	55,000	100,000	25,000	0,79	6	SNR
2211K	55,000	100,000	25,000	0,77	6	SNR
2211KEEG15	55,000	100,000	25,000	0,79	6	SNR
2211S	55,000	100,000	25,000	0,75	6	NTN
2211SK	55,000	100,000	25,000	0,75	6	NTN
2212	60,000	110,000	28,000	1,08	6	SNR
2212EEG15	60,000	110,000	28,000	1,16	6	SNR
2212K	60,000	110,000	28,000	1,08	6	SNR
2212S	60,000	110,000	28,000	1,03	6	NTN
2212SK	60,000	110,000	28,000	1,03	6	NTN
2213	65,000	120,000	31,000	1,49	6	SNR
2213K	65,000	120,000	31,000	1,45	6	SNR
2213S	65,000	120,000	31,000	1,40	6	NTN
2213SK	65,000	120,000	31,000	1,40	6	NTN
2214	70,000	125,000	31,000	1,58	6	SNR
2214S	70,000	125,000	31,000	1,52	6	NTN
2215	75,000	130,000	31,000	1,63	6	SNR
2215K	75,000	130,000	31,000	1,61	6	SNR
2215S	75,000	130,000	31,000	1,60	6	NTN
2215SK	75,000	130,000	31,000	1,60	6	NTN
2216	80,000	140,000	33,000	2,07	6	SNR
2216K	80,000	140,000	33,000	2,06	6	SNR
2216S	80,000	140,000	33,000	1,97	6	NTN
2216SK	80,000	140,000	33,000	1,97	6	NTN
2217S	85,000	150,000	36,000	2,48	6	NTN
2217SK	85,000	150,000	36,000	2,48	6	NTN
2218	90,000	160,000	40,000	3,28	6	SNR
2218K	90,000	160,000	40,000	3,21	6	SNR
2218S	90,000	160,000	40,000	3,13	6	NTN
2218SK	90,000	160,000	40,000	3,13	6	NTN
2219S	95,000	170,000	43,000	3,87	6	NTN
2219SK	95,000	170,000	43,000	3,87	6	NTN
2220	100,000	180,000	46,000	4,80	6	SNR
2220K	100,000	180,000	46,000	4,72	6	SNR
2220S	100,000	180,000	46,000	4,53	6	NTN

Reference	d	D	B	Kg	Brands
2220SK	100,000	180,000	46,000	4,53	6 NTN
2221S	105,000	190,000	50,000	5,64	6 NTN
2222S	110,000	200,000	53,000	6,64	6 NTN
2222SK	110,000	200,000	53,000	6,64	6 NTN
2300S	10,000	35,000	17,000	0,08	6 NTN
2301S	12,000	37,000	17,000	0,08	6 NTN
2302G15	15,000	42,000	17,000	0,11	6 SNR
2302S	15,000	42,000	17,000	0,11	6 NTN
2303EEG14	17,000	47,000	19,000	0,17	6 SNR
2303G14	17,000	47,000	19,000	0,16	6 SNR
2303S	17,000	47,000	19,000	0,15	6 NTN
2304EEG15	20,000	52,000	21,000	0,22	6 SNR
2304S	20,000	52,000	21,000	0,19	6 NTN
2304SK	20,000	52,000	21,000	0,19	6 NTN
2305EEG15	25,000	62,000	24,000	0,35	6 SNR
2305G15	25,000	62,000	24,000	0,33	6 SNR
2305KG15	25,000	62,000	24,000	0,33	6 SNR
2305S	25,000	62,000	24,000	0,32	6 NTN
2305SK	25,000	62,000	24,000	0,32	6 NTN
2306	30,000	72,000	27,000	0,51	6 SNR
2306EEG15	30,000	72,000	27,000	0,57	6 SNR
2306K	30,000	72,000	27,000	0,50	6 SNR
2306S	30,000	72,000	27,000	0,48	6 NTN
2306SK	30,000	72,000	27,000	0,48	6 NTN
2307EEG15	35,000	80,000	31,000	0,72	6 SNR
2307G15	35,000	80,000	31,000	0,66	6 SNR
2307KG15	35,000	80,000	31,000	0,65	6 SNR
2307S	35,000	80,000	31,000	0,64	6 NTN
2307SK	35,000	80,000	31,000	0,64	6 NTN
2308EEG15	40,000	90,000	33,000	1,05	6 SNR
2308G15	40,000	90,000	33,000	0,92	6 SNR
2308K	40,000	90,000	33,000	0,95	6 SNR
2308KG15	40,000	90,000	33,000	0,90	6 SNR
2308S	40,000	90,000	33,000	0,89	6 NTN
2308SK	40,000	90,000	33,000	0,89	6 NTN
2309EEG15	45,000	100,000	36,000	1,40	6 SNR
2309G15	45,000	100,000	36,000	1,21	6 SNR
2309K	45,000	100,000	36,000	1,24	6 SNR
2309KG15	45,000	100,000	36,000	1,19	6 SNR
2309S	45,000	100,000	36,000	1,20	6 NTN
2309SK	45,000	100,000	36,000	1,20	6 NTN
2310EEG15	50,000	110,000	40,000	1,89	6 SNR
2310G15	50,000	110,000	40,000	1,62	6 SNR
2310K	50,000	110,000	40,000	1,68	6 SNR
2310KG15	50,000	110,000	40,000	1,58	6 SNR
2310S	50,000	110,000	40,000	1,58	6 NTN
2310SK	50,000	110,000	40,000	1,58	6 NTN
2311G15	55,000	120,000	43,000	2,07	6 SNR

Reference	d	D	B	Kg	Brands
2311K	55,000	120,000	43,000	2,12	6 SNR
2311KG15	55,000	120,000	43,000	2,01	6 SNR
2311S	55,000	120,000	43,000	2,03	6 NTN
2311SK	55,000	120,000	43,000	2,03	6 NTN
2312	60,000	130,000	46,000	2,60	6 SNR
2312G15	60,000	130,000	46,000	2,64	6 SNR
2312K	60,000	130,000	46,000	2,63	6 SNR
2312KG15	60,000	130,000	46,000	2,52	6 SNR
2312S	60,000	130,000	46,000	2,57	6 NTN
2312SK	60,000	130,000	46,000	2,57	6 NTN
2313G15	65,000	140,000	48,000	3,17	6 SNR
2313K	65,000	140,000	48,000	3,15	6 SNR
2313KG15	65,000	140,000	48,000	3,07	6 SNR
2313S	65,000	140,000	48,000	3,20	6 NTN
2313SK	65,000	140,000	48,000	3,20	6 NTN
2314	70,000	150,000	51,000	3,97	6 SNR
2314S	70,000	150,000	51,000	3,90	6 NTN
2315	75,000	160,000	55,000	4,92	6 SNR
2315K	75,000	160,000	55,000	4,78	6 SNR
2315S	75,000	160,000	55,000	4,77	6 NTN
2315SK	75,000	160,000	55,000	4,77	6 NTN
2316S	80,000	170,000	58,000	5,54	6 NTN
2316SK	80,000	170,000	58,000	5,54	6 NTN
2317S	85,000	180,000	60,000	6,56	6 NTN
2317SK	85,000	180,000	60,000	6,56	6 NTN
2318	90,000	190,000	64,000	7,96	6 SNR
2318K	90,000	190,000	64,000	7,66	6 SNR
2318S	90,000	190,000	64,000	7,76	6 NTN
2318SK	90,000	190,000	64,000	7,76	6 NTN
2319S	95,000	200,000	67,000	9,01	6 NTN
2319SK	95,000	200,000	67,000	9,01	6 NTN
2320S	100,000	215,000	73,000	11,60	6 NTN
2320SK	100,000	215,000	73,000	11,60	6 NTN
2321S	105,000	225,000	77,000	14,40	6 NTN
2322S	110,000	240,000	80,000	17,40	6 NTN
2322SK	110,000	240,000	80,000	17,40	6 NTN
25TAG12	25,000	48,600	15,800	0,12	34 NTN
28TAG12	28,000	51,600	15,800	0,12	34 NTN
2J-DF07A02LLA4CS21/L417	35,000	55,000	20,000	0,144	5 NTN
2J-DF07A02LLA-N5CS30/L417	35,000	55,000	20,000	0,144	5 NTN
2J-DF07A52LA1X-GLRA-YCS38PX1/L453	35,000	62,000	25,500	0,292	5 NTN
2J-DF07A64LLAX4-BCS33/L325	35,000	52,000	20,000	0,106	5 NTN
2J-DF07R10LLA4X-GCS28/L417	35,000	52,000	20,000	0,105	5 NTN
2TS2-7MC3-QJ318L1BC4P6S20	90,000	190,000	43,000	5,018	3 NTN
2TS2-7MC3-QJ318L1BW-1C4P6S20	90,000	190,000	43,000	5,018	3 NTN
2TS2-DF067LLUCS21/7NQ1	30,000	55,000	23,000	0,203	5 NTN
2TS2-DF067LLHCS16PX1/5C	32,000	52,000	20,000	0,127	5 NTN
2TS2-DF06A78LLA4-BCS28PX1/L696	30,000	47,000	18,000	0,086	5 NTN



Reference	d	D	B	Kg		Brands
2TS2-DF06A78LLA4-BCS28PX1V1	30,000	47,000	18,000	0,087	5	NTN
2TS2-DF0716LLBSC47/2E	35,000	55,000	20,000	0,148	5	NTN
2TS2-DF0716LLHACS35/L283	35,000	55,000	20,000	0,148	5	NTN
2TS2-DF0719LLX2CS35/L310	35,000	55,000	20,000	0,144	5	NTN
2TS2-DF0719LLX2CS35/L417	35,000	55,000	20,000	0,144	5	NTN
2TS2-DF0719LLX2-GCS35/L310	35,000	55,000	20,000	0,144	5	NTN
2TS2-DF0785LLA4X-GCS33/L417	35,000	50,000	20,000	0,950	5	NTN
2TS2-DF07A02LLX2-GCS35/L417	35,000	55,000	20,000	0,144	5	NTN
2TS2-DF07R12LLHA1CS33/L325	35,000	62,000	24,000	0,249	5	NTN
2TS2-DF07R12LLUCS35/L417	35,000	62,000	24,000	0,249	5	NTN
2TS2-DF07R17LLA4X3-N1CS21/L417	35,000	50,000	20,000	0,109	5	NTN
2TS2-DF07R21LLA4-GCS33/L417	35,000	52,000	20,000	0,109	5	NTN
2TS2-DF0863LLACS56/5C	40,000	62,000	20,638	0,190	5	NTN
2TS2-DF0863LLHCS30/L310	40,000	62,000	20,638	0,190	5	NTN
2TS2-DF0865LLBSC45/5C	40,000	62,000	24,000	0,214	5	NTN
2TS2-DF08A18LLCS27/L417	40,000	66,000	24,000	0,250	5	NTN
2TS2-DF0954LLHA1CS67/2E	45,000	68,000	20,638	0,222	5	NTN
2TS2-QJ214AW-1C4PX2S20	70,000	125,000	24,000	1,076	3	NTN
2TS2-QJ215DW-4C4P6S10	75,000	130,000	25,000	1,185	3	NTN
3200A	10,000	30,000	14,000	0,05	5	SNR
3201A	12,000	32,000	15,900	0,06	5	SNR
3202A	15,000	35,000	15,900	0,07	5	SNR
3203A	17,000	40,000	17,500	0,13	5	SNR
3204A	20,000	47,000	20,600	0,17	5	SNR
3205B	25,000	52,000	20,600	0,20	5	SNR
3206B	30,000	62,000	23,800	0,32	5	SNR
3207B	35,000	72,000	27,000	0,49	5	SNR
3208B	40,000	80,000	30,200	0,65	5	SNR
3209A	45,000	85,000	30,200	0,66	5	SNR
3210A	50,000	90,000	30,200	0,69	5	SNR
3211A	55,000	100,000	33,300	0,97	5	SNR
3212A	60,000	110,000	36,500	1,36	5	SNR
3213A	65,000	120,000	38,100	1,65	5	SNR
3214A	70,000	125,000	39,700	1,89	5	SNR
3215A	75,000	130,000	41,300	1,91	5	SNR
3216A	80,000	140,000	44,400	2,45	5	SNR
3217	85,000	150,000	49,200	3,60	5	SNR
3218	90,000	160,000	52,400	4,40	5	SNR
32TAG12	32,000	57,000	17,000	0,17	34	NTN
3302A	15,000	42,000	19,000	0,13	5	SNR
3303A	17,000	47,000	22,200	0,19	5	SNR
3304B	20,000	52,000	22,200	0,24	5	SNR
3305B	25,000	62,000	25,400	0,37	5	SNR
3306B	30,000	72,000	30,200	0,60	5	SNR
3307B	35,000	80,000	34,900	0,80	5	SNR
3308B	40,000	90,000	36,500	1,06	5	SNR
3309A	45,000	100,000	39,700	1,34	5	SNR
3310A	50,000	110,000	44,400	1,77	5	SNR
3311A	55,000	120,000	49,200	2,53	5	SNR
3311B	55,000	120,000	49,200	2,66	5	SNR
3312A	60,000	130,000	54,000	3,37	5	SNR

Reference	d	D	B	Kg		Brands
3313A	65,000	140,000	58,700	4,20	5	SNR
3314B	70,000	150,000	63,500	5,10	5	SNR
3316	80,000	170,000	68,300	6,89	5	SNR
3318	90,000	190,000	73,000	9,22	5	SNR
3TM-DF05A35NX16RX3W3-5CS25	25,000	52,000	20,600	0,186	5	NTN
3TM-DF07A24CS25	33,000	62,000	26,000	0,303	5	NTN
4200A	10,000	30,000	14,000	0,06	4	SNR
4201A	12,000	32,000	14,000	0,06	4	SNR
4202A	15,000	35,000	14,000	0,07	4	SNR
4203A	17,000	40,000	16,000	0,10	4	SNR
4204A	20,000	47,000	18,000	0,16	4	SNR
4205A	25,000	52,000	18,000	0,17	4	SNR
4206A	30,000	62,000	20,000	0,26	4	SNR
4207A	35,000	72,000	23,000	0,41	4	SNR
4208A	40,000	80,000	23,000	0,51	4	SNR
4209A	45,000	85,000	23,000	0,56	4	SNR
4210A	50,000	90,000	23,000	0,58	4	SNR
4211A	55,000	100,000	25,000	0,82	4	SNR
4212A	60,000	110,000	28,000	1,10	4	SNR
4213A	65,000	120,000	31,000	1,45	4	SNR
4214A	70,000	125,000	31,000	1,51	4	SNR
4215A	75,000	130,000	31,000	1,81	4	SNR
4216A	80,000	140,000	33,000	2,28	4	SNR
4217A	85,000	150,000	36,000	2,51	4	SNR
4302A	15,000	42,000	17,000	0,12	4	SNR
4303A	17,000	47,000	19,000	0,17	4	SNR
4304A	20,000	52,000	21,000	0,21	4	SNR
4305A	25,000	62,000	24,000	0,34	4	SNR
4306A	30,000	72,000	27,000	0,52	4	SNR
4307A	35,000	80,000	31,000	0,70	4	SNR
4308A	40,000	90,000	33,000	0,93	4	SNR
4309A	45,000	100,000	36,000	1,24	4	SNR
4310A	50,000	110,000	40,000	1,64	4	SNR
4311A	55,000	120,000	43,000	2,08	4	SNR
4312A	60,000	130,000	46,000	2,56	4	SNR
4313A	65,000	140,000	48,000	3,22	4	SNR
45TAG12	45,000	75,400	21,200	0,37	34	NTN
50TAG12	50,000	80,400	23,200	0,43	34	NTN
511/530	530,000	640,000	85,000	55,80	34	NTN
511/560	560,000	670,000	85,000	59,40	34	NTN
511/630	630,000	750,000	95,000	82,50	34	NTN
511/710	710,000	850,000	112,000	124,87	34	NTN
51100	10,000	24,000	9,000	0,02	34	NTN-SNR
51101	12,000	26,000	9,000	0,02	34	NTN-SNR
51102	15,000	28,000	9,000	0,02	34	NTN-SNR
51103	17,000	30,000	9,000	0,02	34	NTN-SNR
51103J	17,000	30,000	9,000	0,03	34	NTN
51104	20,000	35,000	10,000	0,03	34	NTN-SNR
51105	25,000	42,000	11,000	0,05	34	NTN-SNR
51105J	25,000	42,000	11,000	0,06	34	NTN

Reference	d	D	B	Kg		Brands
51106	30,000	47,000	11,000	0,06	34	NTN-SNR
51106J	30,000	47,000	11,000	0,06	34	NTN
51107	35,000	52,000	12,000	0,08	34	NTN-SNR
51107J	35,000	52,000	12,000	0,08	34	NTN
51108	40,000	60,000	13,000	0,12	34	NTN-SNR
51109	45,000	65,000	14,000	0,14	34	NTN-SNR
51110	50,000	70,000	14,000	0,15	34	NTN-SNR
51111	55,000	78,000	16,000	0,23	34	NTN-SNR
51112	60,000	85,000	17,000	0,27	34	NTN-SNR
51113	65,000	90,000	18,000	0,31	34	NTN
51114	70,000	95,000	18,000	0,36	34	NTN-SNR
51115	75,000	100,000	19,000	0,40	34	NTN-SNR
51116	80,000	105,000	19,000	0,40	34	NTN-SNR
51117	85,000	110,000	19,000	0,44	34	NTN-SNR
51118	90,000	120,000	22,000	0,65	34	NTN-SNR
51120	100,000	135,000	25,000	0,96	34	NTN-SNR
51122	110,000	145,000	25,000	1,04	34	NTN-SNR
51124	120,000	155,000	25,000	1,21	34	NTN-SNR
51126	130,000	170,000	30,000	1,64	34	NTN-SNR
51128	140,000	180,000	31,000	1,78	34	NTN
51130	150,000	190,000	31,000	1,93	34	NTN-SNR
51132	160,000	200,000	31,000	2,05	34	NTN-SNR
51134	170,000	215,000	34,000	2,78	34	NTN
51136	180,000	225,000	34,000	2,72	34	NTN
51138	190,000	240,000	37,000	3,52	34	NTN
51140	200,000	250,000	37,000	3,74	34	NTN
51144	220,000	270,000	37,000	4,00	34	NTN
51148	240,000	300,000	45,000	6,48	34	NTN
51152	260,000	320,000	45,000	6,91	34	NTN
51156	280,000	350,000	53,000	11,10	34	NTN
51160	300,000	380,000	62,000	17,50	34	NTN
51164	320,000	400,000	63,000	17,40	34	NTN
51168	340,000	420,000	64,000	18,60	34	NTN
51172	360,000	440,000	65,000	19,98	34	NTN
51176	380,000	460,000	65,000	21,00	34	NTN
51180	400,000	480,000	65,000	21,90	34	NTN
51184	420,000	500,000	65,000	22,94	34	NTN
51188	440,000	540,000	80,000	38,08	34	NTN
51192	460,000	560,000	80,000	41,60	34	NTN
51200	10,000	26,000	10,000	0,03	34	NTN
51200J	10,000	26,000	10,000	0,03	34	NTN
51201	12,000	28,000	11,000	0,03	34	NTN
51201J	12,000	28,000	11,000	0,03	34	NTN
51202	15,000	32,000	12,000	0,04	34	NTN-SNR
51203	17,000	35,000	12,000	0,05	34	NTN-SNR
51203J	17,000	35,000	12,000	0,05	34	NTN
51204	20,000	40,000	14,000	0,08	34	NTN-SNR
51205	25,000	47,000	15,000	0,11	34	NTN-SNR
51205J	25,000	47,000	15,000	0,11	34	NTN
51206	30,000	52,000	16,000	0,13	34	NTN-SNR
51206J	30,000	52,000	16,000	0,14	34	NTN

Reference	d	D	B	Kg		Brands
51207	35,000	62,000	18,000	0,20	34	NTN-SNR
51208	40,000	68,000	19,000	0,26	34	NTN-SNR
51209	45,000	73,000	20,000	0,32	34	NTN-SNR
51210	50,000	78,000	22,000	0,37	34	NTN-SNR
51211	55,000	90,000	25,000	0,59	34	NTN-SNR
51212	60,000	95,000	26,000	0,67	34	NTN
51213	65,000	100,000	27,000	0,74	34	NTN-SNR
51214	70,000	105,000	27,000	0,79	34	NTN-SNR
51215	75,000	110,000	27,000	0,83	34	NTN-SNR
51216	80,000	115,000	28,000	0,91	34	NTN-SNR
51217	85,000	125,000	31,000	1,28	34	NTN-SNR
51218	90,000	135,000	35,000	1,69	34	NTN
51220	100,000	150,000	38,000	2,23	34	NTN
51222	110,000	160,000	38,000	2,42	34	NTN
51224	120,000	170,000	39,000	2,66	34	NTN
51226	130,000	190,000	45,000	4,08	34	NTN
51228	140,000	200,000	46,000	4,43	34	NTN
51230	150,000	215,000	50,000	5,71	34	NTN
51232	160,000	225,000	51,000	6,15	34	NTN
51234	170,000	240,000	55,000	7,48	34	NTN
51236	180,000	250,000	56,000	8,07	34	NTN
51238	190,000	270,000	62,000	10,80	34	NTN
51240	200,000	280,000	62,000	11,40	34	NTN
51244	220,000	300,000	63,000	12,50	34	NTN
51248	240,000	340,000	78,000	21,60	34	NTN
51252	260,000	360,000	79,000	23,40	34	NTN
51256	280,000	380,000	80,000	26,10	34	NTN
51260	300,000	420,000	95,000	38,70	34	NTN
51264	320,000	440,000	95,000	42,30	34	NTN
51268	340,000	460,000	96,000	43,40	34	NTN
51272	360,000	500,000	110,000	63,90	34	NTN
51292	460,000	620,000	130,000	106,00	34	NTN
51304	20,000	47,000	18,000	0,14	34	NTN
51305	25,000	52,000	18,000	0,16	34	NTN-SNR
51306	30,000	60,000	21,000	0,26	34	NTN-SNR
51307	35,000	68,000	24,000	0,38	34	NTN-SNR
51308	40,000	78,000	26,000	0,53	34	NTN-SNR
51309	45,000	85,000	28,000	0,67	34	NTN-SNR
51310	50,000	95,000	31,000	0,92	34	NTN
51311	55,000	105,000	35,000	1,28	34	NTN-SNR
51314	70,000	125,000	40,000	1,99	34	NTN
51315	75,000	135,000	44,000	2,57	34	NTN
51316	80,000	140,000	44,000	2,71	34	NTN
51317	85,000	150,000	49,000	3,49	34	NTN
51318	90,000	155,000	50,000	3,74	34	NTN
51320	100,000	170,000	55,000	4,97	34	NTN
51322	110,000	190,000	63,000	7,25	34	NTN
51324	120,000	210,000	70,000	9,88	34	NTN
51326	130,000	220,000	75,000	12,70	34	NTN
51328	140,000	240,000	80,000	14,50	34	NTN
51330	150,000	250,000	80,000	15,30	34	NTN
51332	160,000	270,000	87,000	19,90	34	NTN



Reference	d	D	B	Kg		Brands
51334	170,000	280,000	87,000	20,80	34	NTN
51336	180,000	300,000	95,000	25,80	34	NTN
51338	190,000	320,000	105,000	33,60	34	NTN
51340	200,000	340,000	110,000	40,20	34	NTN
51405	25,000	60,000	24,000	0,32	34	NTN-SNR
51406	30,000	70,000	28,000	0,52	34	NTN-SNR
51407	35,000	80,000	32,000	0,76	34	NTN-SNR
51408	40,000	90,000	36,000	1,09	34	NTN
51409	45,000	100,000	39,000	1,43	34	NTN-SNR
51410	50,000	110,000	43,000	1,88	34	NTN
51410A	50,000	110,000	43,000	1,88	34	NTN
51411	55,000	120,000	48,000	2,55	34	NTN
51412	60,000	130,000	51,000	3,17	34	NTN
51413	65,000	140,000	56,000	4,03	34	NTN
51414	70,000	150,000	60,000	4,94	34	NTN
51415	75,000	160,000	65,000	5,97	34	NTN
51416	80,000	170,000	68,000	7,42	34	NTN-SNR
51417	85,000	180,000	72,000	8,68	34	NTN
51418	90,000	190,000	77,000	10,20	34	NTN
51420	100,000	210,000	85,000	13,70	34	NTN
51432	160,000	320,000	130,000	49,00	34	NTN
51434	170,000	340,000	135,000	55,80	34	NTN
5200S	10,000	30,000	14,300	0,05	5	NTN
5200SCLLD	10,000	30,000	14,300	0,05	5	NTN
5200SCLLM	10,000	30,000	14,300	0,05	5	NTN
5200SCZZ	10,000	30,000	14,300	0,05	5	NTN
5201EEG15	12,000	32,000	15,900	0,06	5	SNR
5201S	12,000	32,000	15,900	0,06	5	NTN
5201SCLLD	12,000	32,000	15,900	0,06	5	NTN
5201SCLLM	12,000	32,000	15,900	0,06	5	NTN
5201SCZZ	12,000	32,000	15,900	0,06	5	NTN
5201ZZG15	12,000	32,000	15,900	0,06	5	SNR
5202EEG15	15,000	35,000	15,900	0,07	5	SNR
5202NRZZG15	15,000	35,000	15,900	0,07	5-NR	SNR
5202S	15,000	35,000	15,900	0,07	5	NTN
5202SCLLD	15,000	35,000	15,900	0,07	5	NTN
5202SCLLM	15,000	35,000	15,900	0,07	5	NTN
5202SCZZ	15,000	35,000	15,900	0,07	5	NTN
5202ZZG15	15,000	35,000	15,900	0,07	5	SNR
5203EEG15	17,000	40,000	17,500	0,10	5	SNR
5203NRZZG15	17,000	40,000	17,500	0,10	5-NR	SNR
5203S	17,000	40,000	17,500	0,09	5	NTN
5203SCLLD	17,000	40,000	17,500	0,11	5	NTN
5203SCLLM	17,000	40,000	17,500	0,11	5	NTN
5203SCZZ	17,000	40,000	17,500	0,11	5	NTN
5203ZZG15	17,000	40,000	17,500	0,10	5	SNR
5204EEG15	20,000	47,000	20,600	0,16	5	SNR
5204NRZZG15	20,000	47,000	20,600	0,16	5-NR	SNR
5204S	20,000	47,000	20,600	0,12	5	NTN
5204SCLLD	20,000	47,000	20,600	0,12	5	NTN
5204SCLLM	20,000	47,000	20,600	0,12	5	NTN
5204SCZZ	20,000	47,000	20,600	0,12	5	NTN
5204ZZG15	20,000	47,000	20,600	0,14	5	SNR

Reference	d	D	B	Kg		Brands
5205EEG15EE	25,000	52,000	20,600	0,17	5	SNR
5205NREEG15	25,000	52,000	20,600	0,19	5-NR	SNR
5205NRZZG15	25,000	52,000	20,600	0,19	5-NR	SNR
5205S	25,000	52,000	20,600	0,19	5	NTN
5205SCLLD	25,000	52,000	20,600	0,19	5	NTN
5205SCLLM	25,000	52,000	20,600	0,19	5	NTN
5205SCZZ	25,000	52,000	20,600	0,19	5	NTN
5205ZZG15	25,000	52,000	20,600	0,18	5	SNR
5206EEG15EE	30,000	62,000	23,800	0,29	5	SNR
5206NRZZG15	30,000	62,000	23,800	0,30	5-NR	SNR
5206S	30,000	62,000	23,800	0,29	5	NTN
5206SCLLD	30,000	62,000	23,800	0,29	5	NTN
5206SCLLM	30,000	62,000	23,800	0,29	5	NTN
5206SCZZ	30,000	62,000	23,800	0,29	5	NTN
5206ZZG15	30,000	62,000	23,800	0,29	5	SNR
5207EEG15	35,000	72,000	27,000	0,45	5	SNR
5207NRZZG15	35,000	72,000	27,000	0,46	5-NR	SNR
5207S	35,000	72,000	27,000	0,43	5	NTN
5207SCLLD	35,000	72,000	27,000	0,43	5	NTN
5207SCLLM	35,000	72,000	27,000	0,43	5	NTN
5207SCZZ	35,000	72,000	27,000	0,43	5	NTN
5207ZZG15	35,000	72,000	27,000	0,46	5	SNR
5208EEG15	40,000	80,000	30,200	0,60	5	SNR
5208NRZZG15	40,000	80,000	30,200	0,62	5-NR	SNR
5208S	40,000	80,000	30,200	0,57	5	NTN
5208SCLLD	40,000	80,000	30,200	0,57	5	NTN
5208SCLLM	40,000	80,000	30,200	0,57	5	NTN
5208SCZZ	40,000	80,000	30,200	0,57	5	NTN
5208ZZG15	40,000	80,000	30,200	0,59	5	SNR
5209EEG15	45,000	85,000	30,200	0,64	5	SNR
5209NRZZG15	45,000	85,000	30,200	0,71	5-NR	SNR
5209S	45,000	85,000	30,200	0,62	5	NTN
5209ZZG15	45,000	85,000	30,200	0,65	5	SNR
5210EEG15	50,000	90,000	30,200	0,70	5	SNR
5210NRZZG15	50,000	90,000	30,200	0,76	5-NR	SNR
5210S	50,000	90,000	30,200	0,67	5	NTN
5210ZZG15	50,000	90,000	30,200	0,69	5	SNR
5211EEG15	55,000	100,000	33,300	0,95	5	SNR
5211NRZZG15	55,000	100,000	33,300	0,98	5-NR	SNR
5211S	55,000	100,000	33,300	0,96	5	NTN
5211ZZG15	55,000	100,000	33,300	0,88	5	SNR
5212EEG15	60,000	110,000	36,500	1,28	5	SNR
5212NRZZG15	60,000	110,000	36,500	1,29	5-NR	SNR
5212S	60,000	110,000	36,500	1,35	5	NTN
5212ZZG15	60,000	110,000	36,500	1,18	5	SNR
5213EEG15	65,000	120,000	38,100	1,64	5	SNR
5213NRZZG15	65,000	120,000	38,100	1,67	5-NR	SNR
5213S	65,000	120,000	38,100	1,65	5	NTN
5213ZZG15	65,000	120,000	38,100	1,63	5	SNR
5214EEG15	70,000	125,000	39,700	1,81	5	SNR
5214NRZZG15	70,000	125,000	39,700	1,84	5-NR	SNR
5214S	70,000	125,000	39,700	1,80	5	NTN
5214ZZG15	70,000	125,000	39,700	1,80	5	SNR

Reference	d	D	B	Kg	Brands	
5215S	75,000	130,000	41,300	1,90	5	NTN
5216S	80,000	140,000	44,400	2,50	5	NTN
5217S	85,000	150,000	49,200	3,40	5	NTN
52TMK804	52,400	94,000	20,000	0,49	34	NTN
5302EEG15	15,000	42,000	19,000	0,13	5	SNR
5302S	15,000	42,000	19,000	0,11	5	NTN
5303EEG15	17,000	47,000	22,200	0,19	5	SNR
5303NRZZG15	17,000	47,000	22,200	0,19	5-NR	SNR
5303S	17,000	47,000	22,200	0,14	5	NTN
5303SCLLD	17,000	47,000	22,200	0,09	5	NTN
5303SCLLM	17,000	47,000	22,200	0,09	5	NTN
5303SCZZ	17,000	47,000	22,200	0,09	5	NTN
5303ZZG15	17,000	47,000	22,200	0,19	5	SNR
5304EEG15	20,000	52,000	22,200	0,22	5	SNR
5304NRZZG15	20,000	52,000	22,200	0,23	5-NR	SNR
5304S	20,000	52,000	22,200	0,23	5	NTN
5304ZZG15	20,000	52,000	22,200	0,22	5	SNR
5305EEG15	25,000	62,000	25,400	0,35	5	SNR
5305NRZZG15	25,000	62,000	25,400	0,42	5-NR	SNR
5305S	25,000	62,000	25,400	0,34	5	NTN
5305SCLLD	25,000	62,000	25,400	0,34	5	NTN
5305SCLLM	25,000	62,000	25,400	0,34	5	NTN
5305SCZZ	25,000	62,000	25,400	0,34	5	NTN
5305ZZG15	25,000	62,000	25,400	0,36	5	SNR
5306EEG15	30,000	72,000	30,200	0,56	5	SNR
5306NRZZG15	30,000	72,000	30,200	0,57	5-NR	SNR
5306S	30,000	72,000	30,200	0,51	5	NTN
5306SCLLD	30,000	72,000	30,200	0,51	5	NTN
5306SCLLM	30,000	72,000	30,200	0,51	5	NTN
5306SCZZ	30,000	72,000	30,200	0,51	5	NTN
5306ZZG15	30,000	72,000	30,200	0,51	5	SNR
5307EEG15	35,000	80,000	34,900	0,75	5	SNR
5307NRZZG15	35,000	80,000	34,900	0,84	5-NR	SNR
5307S	35,000	80,000	34,900	0,79	5	NTN
5307SCLLD	35,000	80,000	34,900	0,79	5	NTN
5307SCLLM	35,000	80,000	34,900	0,79	5	NTN
5307SCZZ	35,000	80,000	34,900	0,79	5	NTN
5307ZZG15	35,000	80,000	34,900	0,74	5	SNR
5308EEG15	40,000	90,000	36,500	1,00	5	SNR
5308NRZZG15	40,000	90,000	36,500	1,02	5-NR	SNR
5308S	40,000	90,000	36,500	1,05	5	NTN
5308SCLLD	40,000	90,000	36,500	1,05	5	NTN
5308SCLLM	40,000	90,000	36,500	1,05	5	NTN
5308SCZZ	40,000	90,000	36,500	1,05	5	NTN
5308ZZG15	40,000	90,000	36,500	1,01	5	SNR
5309EEG15	45,000	100,000	39,700	1,33	5	SNR
5309NRZZG15	45,000	100,000	39,700	1,34	5-NR	SNR
5309S	45,000	100,000	39,700	1,40	5	NTN
5309ZZG15	45,000	100,000	39,700	1,33	5	SNR
5310EEG15	50,000	110,000	44,400	1,80	5	SNR
5310NRZZG15	50,000	110,000	44,400	1,80	5-NR	SNR
5310S	50,000	110,000	44,400	1,95	5	NTN

Reference	d	D	B	Kg	Brands	
5310ZZG15	50,000	110,000	44,400	1,93	5	SNR
5311NRZZG15	55,000	120,000	49,200	2,35	5-NR	SNR
5311S	55,000	120,000	49,200	2,30	5	NTN
5311ZZG15	55,000	120,000	49,200	2,31	5	SNR
5312NRZZG15	60,000	130,000	54,000	2,93	5-NR	SNR
5312S	60,000	130,000	54,000	3,15	5	NTN
5312ZZG15	60,000	130,000	54,000	2,70	5	SNR
5313NRZZG15	65,000	140,000	58,700	3,68	5-NR	SNR
5313S	65,000	140,000	58,700	3,85	5	NTN
5313ZZG15	65,000	140,000	58,700	3,59	5	SNR
5314S	70,000	150,000	63,500	4,90	5	NTN
55TMK804X	55,000	88,000	19,600	0,37	34	NTN
55TNK29	55,000	82,000	16,000	0,23	34	NTN
55TRK30A	55,000	92,000	25,500	0,51	34	NTN
591/670	670,000	800,000	78,000	71,10	34	NTN
598/592B	92,075	158,468	39,688	2,90	34	NTN
60/1000	1 000,000	1 420,000	185,000	945,00	1	NTN
60/1060	1 060,000	1 500,000	195,000	1 126,00	1	NTN
60/1120	1 120,000	1 580,000	200,000	1 258,00	1	NTN
60/1250	1 250,000	1 750,000	218,000	1 450,00	1	NTN
60/15	1,500	6,000	2,500	0,001	1	NTN
60/22	22,000	44,000	12,000	0,08	1	NTN
60/22LLB	22,000	44,000	12,000	0,07	1	NTN
60/22LLU	22,000	44,000	12,000	0,07	1	NTN
60/22LU	22,000	44,000	12,000	0,07	1	NTN
60/22N	22,000	44,000	12,000	0,07	1-NR	NTN
60/22Z	22,000	44,000	12,000	0,07	1	NTN
60/22ZZ	22,000	44,000	12,000	0,08	1	NTN
60/22ZZNR	22,000	44,000	12,000	0,08	1-NR	NTN
60/25	2,500	8,000	2,800	0,72	1	NTN
60/28	28,000	52,000	12,000	0,10	1	NTN
60/28/29	29,000	52,000	12,000	0,09	1	NTN
60/28LLB	28,000	52,000	12,000	0,09	1	NTN
60/28LLU	28,000	52,000	12,000	0,10	1	NTN
60/28LLUNR	28,000	52,000	12,000	0,09	1-NR	NTN
60/28LU	28,000	52,000	12,000	0,09	1	NTN
60/28LUNR	28,000	52,000	12,000	0,10	1-NR	NTN
60/28NR	28,000	52,000	12,000	0,10	1-NR	NTN
60/28NRD2	28,000	52,000	24,000	0,20	1-NR	NTN
60/28Z	28,000	52,000	12,000	0,09	1	NTN
60/28ZZ	28,000	52,000	12,000	0,10	1	NTN
60/28ZZNR	28,000	52,000	12,000	0,09	1-NR	NTN
60/32	32,000	58,000	13,000	0,13	1	NTN
60/32LLB	32,000	58,000	13,000	0,13	1	NTN
60/32LLU	32,000	58,000	13,000	0,13	1	NTN
60/32LU	32,000	58,000	13,000	0,13	1	NTN
60/32ZZ	32,000	58,000	13,000	0,13	1	NTN
60/32ZZNR	32,000	58,000	13,000	0,14	1-NR	NTN
60/500	500,000	720,000	100,000	112,00	1	NTN
60/530	530,000	780,000	112,000	178,00	1	NTN
60/560	560,000	820,000	115,000	172,00	1	NTN



Reference	d	D	B	Kg		Brands
60/600	600,000	870,000	118,000	228,00	1	NTN
60/630	630,000	920,000	128,000	280,00	1	NTN
60/670	670,000	980,000	136,000	336,00	1	NTN
60/710	710,000	1 030,000	140,000	379,00	1	NTN
60/750	750,000	1 090,000	150,000	457,00	1	NTN
60/800	800,000	1 150,000	155,000	522,00	1	NTN
60/850	850,000	1 220,000	165,000	615,00	1	NTN
60/900	900,000	1 280,000	170,000	685,00	1	NTN
60/950	950,000	1 360,000	180,000	855,00	1	NTN
6000	10,000	26,000	8,000	0,02	1	NTN-SNR
6000E	10,000	26,000	8,000	0,02	1	SNR
6000EE	10,000	26,000	8,000	0,01	1	SNR
6000FT150	10,000	26,000	8,000	0,02	1	SNR
6000FT150ZZ	10,000	26,000	8,000	0,02	1	SNR
6000HVZZ	10,000	26,000	8,000	0,02	1	SNR
6000J	10,000	26,000	8,000	0,02	1	NTN
6000JLLB	10,000	26,000	8,000	0,02	1	NTN
6000J2LLH	10,000	26,000	8,000	0,02	1	NTN
6000LB	10,000	26,000	8,000	0,02	1	NTN
6000LLB	10,000	26,000	8,000	0,02	1	NTN
6000LLH	10,000	26,000	8,000	0,02	1	NTN
6000LLU	10,000	26,000	8,000	0,02	1	NTN
6000LT	10,000	26,000	8,000	0,11	1	SNR
6000LTZZ	10,000	26,000	8,000	0,11	1	SNR
6000LU	10,000	26,000	8,000	0,02	1	NTN
6000Z	10,000	26,000	8,000	0,02	1	NTN-SNR
6000ZZ	10,000	26,000	8,000	0,02	1	NTN-SNR
6000ZG15	10,000	26,000	8,000	0,02	1	SNR
6001	12,000	28,000	8,000	0,02	1	NTN-SNR
6001E	12,000	28,000	8,000	0,02	1	SNR
6001EE	12,000	28,000	8,000	0,02	1	SNR
6001F579	12,000	28,000	8,000	0,02	1	SNR
6001FT150	12,000	28,000	8,000	0,03	1	SNR
6001FT150ZZ	12,000	28,000	8,000	0,02	1	SNR
6001G15	12,000	28,000	8,000	0,02	1	SNR
6001HVZZ	12,000	28,000	8,000	0,02	1	SNR
6001LB	12,000	28,000	8,000	0,02	1	NTN
6001LH	12,000	28,000	8,000	0,02	1	NTN
6001LLB	12,000	28,000	8,000	0,02	1	NTN
6001LLH	12,000	28,000	8,000	0,02	1	NTN
6001LLU	12,000	28,000	8,000	0,02	1	NTN
6001LT	12,000	28,000	8,000	0,02	1	SNR
6001LTZZ	12,000	28,000	8,000	0,03	1	SNR
6001LU	12,000	28,000	8,000	0,02	1	NTN
6001Z	12,000	28,000	8,000	0,02	1	NTN-SNR
6001ZZ	12,000	28,000	8,000	0,02	1	NTN-SNR
6001ZZD2	12,000	28,000	16,000	0,04	1	NTN
6002	15,000	32,000	9,000	0,03	1	NTN-SNR
6002E	15,000	32,000	9,000	0,03	1	SNR
6002EE	15,000	32,000	9,000	0,03	1	SNR
6002FT150	15,000	32,000	9,000	0,02	1	SNR
6002FT150ZZ	15,000	32,000	9,000	0,03	1	SNR
6002HVZZ	15,000	32,000	9,000	0,03	1	SNR
6002LB	15,000	32,000	9,000	0,03	1	NTN
6002LLB	15,000	32,000	9,000	0,03	1	NTN
6002LLBNR	15,000	32,000	9,000	0,03	1-NR	NTN
6002LLU	15,000	32,000	9,000	0,03	1	NTN
6002LLUN	15,000	32,000	9,000	0,03	1-NR	NTN

Reference	d	D	B	Kg		Brands
6002LLUNR	15,000	32,000	9,000	0,03	1-NR	NTN
6002LT	15,000	32,000	9,000	0,03	1	SNR
6002LTZZ	15,000	32,000	9,000	0,03	1	SNR
6002LU	15,000	32,000	9,000	0,03	1	NTN
6002N	15,000	32,000	9,000	0,03	1-NR	SNR
6002NR	15,000	36,700	9,000	0,03	1-NR	NTN
6002NZZ	15,000	32,000	9,000	0,03	1-NR	SNR
6002Z	15,000	32,000	9,000	0,03	1	NTN-SNR
6002ZNR	15,000	32,000	9,000	0,03	1-NR	NTN
6002ZZ	15,000	32,000	9,000	0,03	1	NTN-SNR
6002ZZNR	15,000	32,000	9,000	0,03	1-NR	NTN
6003	17,000	35,000	10,000	0,04	1	NTN-SNR
6003E	17,000	35,000	10,000	0,04	1	SNR
6003EE	17,000	35,000	10,000	0,05	1	SNR
6003FT150	17,000	35,000	10,000	0,04	1	SNR
6003FT150ZZ	17,000	35,000	10,000	0,05	1	SNR
6003HVZZ	17,000	35,000	10,000	0,04	1	SNR
6003LB	17,000	35,000	10,000	0,04	1	NTN
6003LBU	17,000	35,000	10,000	0,04	1	NTN
6003LBZ	17,000	35,000	10,000	0,04	1	NTN
6003LLB	17,000	35,000	10,000	0,04	1	NTN
6003LLBNR	17,000	35,000	10,000	0,04	1-NR	NTN
6003LLH	17,000	35,000	10,000	0,04	1	NTN
6003LLU	17,000	35,000	10,000	0,04	1	NTN
6003LLUN	17,000	35,000	10,000	0,04	1-NR	NTN
6003LLUNR	17,000	35,000	10,000	0,04	1-NR	NTN
6003LT	17,000	35,000	10,000	0,05	1	SNR
6003LTZZ	17,000	35,000	10,000	0,05	1	SNR
6003LU	17,000	35,000	10,000	0,04	1	NTN
6003NR	17,000	35,000	10,000	0,04	1-NR	NTN
6003NREE	17,000	35,000	10,000	0,05	1-NR	SNR
6003Z	17,000	35,000	10,000	0,04	1	NTN-SNR
6003ZNR	17,000	35,000	10,000	0,04	1-NR	NTN
6003ZZ	17,000	35,000	10,000	0,04	1	NTN-SNR
6003ZZN	17,000	35,000	10,000	0,04	1-NR	NTN
6003ZZNR	17,000	35,000	10,000	0,04	1-NR	NTN
6004	20,000	42,000	12,000	0,07	1	NTN-SNR
6004D2	20,000	42,000	24,000	0,14	1	NTN
6004E	20,000	42,000	12,000	0,07	1	SNR
6004EE	20,000	42,000	12,000	0,07	1	SNR
6004F600	20,000	42,000	12,000	0,07	1	SNR
6004F604	20,000	42,000	12,000	0,08	1	SNR
6004F605	20,000	42,000	12,000	0,07	1	SNR
6004FT150	20,000	42,000	12,000	0,07	1	SNR
6004FT150ZZ	20,000	42,000	12,000	0,07	1	SNR
6004HT200	20,000	42,000	12,000	0,07	1	SNR
6004HVZZ	20,000	42,000	12,000	0,07	1	SNR
6004LB	20,000	42,000	12,000	0,07	1	NTN
6004LLB	20,000	42,000	12,000	0,07	1	NTN
6004LLBNR	20,000	42,000	12,000	0,07	1-NR	NTN
6004LLU	20,000	42,000	12,000	0,07	1	NTN
6004LLUNR	20,000	42,000	12,000	0,07	1-NR	NTN
6004LT	20,000	42,000	12,000	0,07	1	SNR
6004LTZZ	20,000	42,000	12,000	0,07	1	SNR
6004LU	20,000	42,000	12,000	0,07	1	NTN
6004NEE	20,000	42,000	12,000	0,07	1-NR	SNR
6004NR	20,000	42,000	12,000	0,07	1-NR	NTN-SNR
6004NREE	20,000	42,000	12,000	0,08	1-NR	SNR
6004NRZZ	20,000	42,000	12,000	0,08	1-NR	SNR
6004Z	20,000	42,000	12,000	0,07	1	NTN-SNR

Reference	d	D	B	Kg	Brands
6004ZNR	20,000	42,000	12,000	0,07	1-NR NTN
6004ZZ	20,000	42,000	12,000	0,07	1 NTN-SNR
6004ZZNR	20,000	42,000	12,000	0,07	1-NR NTN
6005	25,000	47,000	12,000	0,08	1 NTN-SNR
6005E	25,000	47,000	12,000	0,08	1 SNR
6005EE	25,000	47,000	12,000	0,08	1 SNR
6005FT150	25,000	47,000	12,000	0,08	1 SNR
6005FT150ZZ	25,000	47,000	12,000	0,08	1 SNR
6005G15	25,000	47,000	12,000	0,08	1 SNR
6005HVZZ	25,000	47,000	12,000	0,08	1 SNR
6005LB	25,000	47,000	12,000	0,08	1 NTN
6005LLB	25,000	47,000	12,000	0,08	1 NTN
6005LLBNR	25,000	47,000	12,000	0,08	1-NR NTN
6005LLH	25,000	47,000	12,000	0,08	1 NTN
6005LLU	25,000	47,000	12,000	0,08	1 NTN
6005LLUNR	25,000	47,000	12,000	0,08	1-NR NTN
6005LT	25,000	47,000	12,000	0,09	1 SNR
6005LTZZ	25,000	47,000	12,000	0,09	1 SNR
6005LU	25,000	47,000	12,000	0,08	1 NTN
6005LU/50	25,000	50,000	12,000	0,10	1 NTN
6005LUZ	25,000	47,000	12,000	0,08	1 NTN
6005N	25,000	47,000	12,000	0,08	1-NR NTN-SNR
6005NR	25,000	47,000	12,000	0,08	1-NR NTN
6005Z	25,000	47,000	12,000	0,08	1 NTN-SNR
6005ZNR	25,000	47,000	12,000	0,08	1-NR NTN
6005ZZ	25,000	47,000	12,000	0,08	1 NTN-SNR
6005ZZNR	25,000	47,000	12,000	0,08	1-NR NTN
6006	30,000	55,000	13,000	0,12	1 NTN-SNR
6006E	30,000	55,000	13,000	0,12	1 SNR
6006EE	30,000	55,000	13,000	0,12	1 SNR
6006FT150	30,000	55,000	13,000	0,12	1 SNR
6006FT150ZZ	30,000	55,000	13,000	0,12	1 SNR
6006HVZZ	30,000	55,000	13,000	0,12	1 SNR
6006LB	30,000	55,000	13,000	0,11	1 NTN
6006LLB	30,000	50,000	13,000	0,12	1 NTN
6006LLBNR	30,000	55,000	13,000	0,12	1-NR NTN
6006LLH	30,000	55,000	13,000	0,11	1 NTN
6006LLU	30,000	55,000	13,000	0,12	1 NTN
6006LLUN	30,000	55,000	13,000	0,11	1-NR NTN
6006LLUNR	30,000	55,000	13,000	0,12	1-NR NTN
6006LT	30,000	55,000	13,000	0,12	1 SNR
6006LTZZ	30,000	55,000	13,000	0,12	1 SNR
6006LU	30,000	55,000	13,000	0,11	1 NTN
6006N	30,000	55,000	13,000	0,12	1-NR SNR
6006NR	30,000	55,000	13,000	0,12	1-NR NTN-SNR
6006NREE	30,000	55,000	13,000	0,12	1-NR SNR
6006NRZZ	30,000	55,000	13,000	0,13	1-NR SNR
6006Z	30,000	55,000	13,000	0,11	1 NTN-SNR
6006ZNR	30,000	55,000	13,000	0,11	1-NR NTN
6006ZZ	30,000	55,000	13,000	0,12	1 NTN-SNR
6006ZZNR	30,000	55,000	13,000	0,11	1-NR NTN
6007	35,000	62,000	14,000	0,16	1 NTN-SNR
6007C	35,000	62,000	14,000	0,15	1 NTN
6007E	35,000	62,000	14,000	0,16	1 SNR
6007EE	35,000	62,000	14,000	0,16	1 SNR
6007F600	35,000	62,000	14,000	0,15	1 SNR
6007F604	35,000	62,000	14,000	0,16	1 SNR
6007FT150	35,000	62,000	14,000	0,16	1 SNR
6007FT150ZZ	35,000	62,000	14,000	0,16	1 SNR

Reference	d	D	B	Kg	Brands
6007HVZZ	35,000	62,000	14,000	0,16	1 SNR
6007LB	35,000	62,000	14,000	0,14	1 NTN
6007LLB	35,000	62,000	14,000	0,15	1 NTN
6007LLBNR	35,000	62,000	14,000	0,16	1-NR NTN
6007LLU	35,000	62,000	14,000	0,15	1 NTN
6007LLUN	35,000	62,000	14,000	0,15	1-NR NTN
6007LLUNR	35,000	62,000	14,000	0,15	1-NR NTN
6007LTZZ	35,000	62,000	14,000	0,16	1 SNR
6007LU	35,000	62,000	14,000	0,15	1 NTN
6007N	35,000	62,000	14,000	0,16	1-NR SNR
6007NR	35,000	62,000	14,000	0,16	1-NR NTN-SNR
6007NRZZ	35,000	62,000	14,000	0,16	1-NR SNR
6007Z	35,000	62,000	14,000	0,15	1 NTN-SNR
6007ZNR	35,000	62,000	14,000	0,15	1-NR NTN
6007ZZ	35,000	62,000	14,000	0,15	1 NTN-SNR
6007ZZNR	35,000	62,000	14,000	0,16	1-NR NTN
6008	40,000	68,000	15,000	0,19	1 NTN-SNR
6008E	40,000	68,000	15,000	0,19	1 SNR
6008EE	40,000	68,000	15,000	0,20	1 SNR
6008F600	40,000	68,000	15,000	0,19	1 SNR
6008FT150	40,000	68,000	15,000	0,20	1 SNR
6008FT150ZZ	40,000	68,000	15,000	0,19	1 SNR
6008HT200	40,000	68,000	15,000	0,20	1 SNR
6008HVZZ	40,000	68,000	15,000	0,18	1 SNR
6008LB	40,000	68,000	15,000	0,18	1 NTN
6008LLB	40,000	68,000	15,000	0,19	1 NTN
6008LLBN	40,000	68,000	15,000	0,18	1-NR NTN
6008LLBNR	40,000	68,000	15,000	0,20	1-NR NTN
6008LLU	40,000	68,000	15,000	0,18	1 NTN
6008LLUNR	40,000	68,000	15,000	0,19	1-NR NTN
6008LU	40,000	68,000	15,000	0,18	1 NTN
6008LUZ	40,000	68,000	15,000	0,19	1 NTN
6008N	40,000	68,000	15,000	0,19	1-NR NTN
6008NR	40,000	68,000	15,000	0,20	1-NR NTN-SNR
6008NRZZ	40,000	68,000	15,000	0,19	1-NR SNR
6008Z	40,000	68,000	15,000	0,18	1 NTN-SNR
6008ZD2	40,000	68,000	30,000	0,42	1 NTN
6008ZNR	40,000	68,000	15,000	0,19	1-NR NTN
6008ZZ	40,000	68,000	15,000	0,19	1 NTN-SNR
6008ZZNR	40,000	68,000	15,000	0,19	1-NR NTN
6009	45,000	75,000	16,000	0,24	1 NTN-SNR
6009E	45,000	75,000	16,000	0,25	1 SNR
6009EE	45,000	75,000	16,000	0,25	1 SNR
6009FT150	45,000	75,000	16,000	0,25	1 SNR
6009FT150ZZ	45,000	75,000	16,000	0,25	1 SNR
6009HVZZ	45,000	75,000	16,000	0,24	1 SNR
6009LB	45,000	75,000	16,000	0,24	1 NTN
6009LLB	45,000	75,000	16,000	0,24	1 NTN
6009LLBNR	45,000	75,000	16,000	0,25	1-NR NTN
6009LLU	45,000	75,000	16,000	0,24	1 NTN
6009LLUN	45,000	75,000	16,000	0,24	1-NR NTN
6009LLUNR	45,000	75,000	16,000	0,25	1-NR NTN
6009LU	45,000	75,000	16,000	0,24	1 NTN
6009N	45,000	75,000	16,000	0,24	1-NR NTN
6009NR	45,000	75,000	16,000	0,25	1-NR NTN-SNR
6009Z	45,000	75,000	16,000	0,23	1 NTN-SNR
6009ZNR	45,000	75,000	16,000	0,24	1-NR NTN
6009ZZ	45,000	75,000	16,000	0,21	1 NTN-SNR
6009ZZNR	45,000	75,000	16,000	0,24	1-NR NTN



Reference	d	D	B	Kg		Brands
6010	50,000	80,000	16,000	0,27	1	NTN-SNR
6010E	50,000	80,000	16,000	0,26	1	SNR
6010EE	50,000	80,000	16,000	0,27	1	SNR
6010FT150	50,000	80,000	16,000	0,27	1	SNR
6010FT150ZZ	50,000	80,000	16,000	0,27	1	SNR
6010HVZZ	50,000	80,000	16,000	0,27	1	SNR
6010LB	50,000	80,000	16,000	0,25	1	NTN
6010LLB	50,000	80,000	16,000	0,26	1	NTN
6010LLBNR	50,000	80,000	16,000	0,27	1-NR	NTN
6010LLC	50,000	80,000	16,000	0,25	1	NTN
6010LLH	50,000	80,000	16,000	0,25	1	NTN
6010LLU	45,000	85,000	19,000	0,26	1	NTN
6010LLUNR	50,000	80,000	16,000	0,26	1-NR	NTN
6010LU	50,000	80,000	16,000	0,25	1	NTN
6010N	50,000	80,000	16,000	0,24	1-NR	NTN-SNR
6010NEE	50,000	80,000	16,000	0,28	1-NR	SNR
6010NR	50,000	80,000	16,000	0,25	1-NR	NTN-SNR
6010NREE	50,000	80,000	16,000	0,28	1-NR	SNR
6010NRZ	50,000	80,000	16,000	0,27	1-NR	SNR
6010NRZZ	50,000	80,000	16,000	0,29	1-NR	SNR
6010Z	50,000	80,000	16,000	0,25	1	NTN-SNR
6010ZNR	50,000	80,000	16,000	0,26	1-NR	NTN
6010ZZ	50,000	80,000	16,000	0,26	1	NTN-SNR
6010ZZNR	50,000	80,000	16,000	0,27	1-NR	NTN
6011	55,000	90,000	18,000	0,39	1	NTN-SNR
6011D2	55,000	90,000	36,000	0,78	1	NTN
6011E	55,000	90,000	18,000	0,40	1	SNR
6011EE	55,000	90,000	18,000	0,39	1	SNR
6011HVZZ	55,000	90,000	18,000	0,38	1	SNR
6011LB	55,000	90,000	18,000	0,38	1	NTN
6011LLB	55,000	90,000	18,000	0,39	1	NTN
6011LLBNR	55,000	90,000	18,000	0,40	1-NR	NTN
6011LLU	55,000	90,000	18,000	0,39	1	NTN
6011LLUNR	55,000	90,000	18,000	0,40	1-NR	NTN
6011LU	55,000	90,000	18,000	0,38	1	NTN
6011N	55,000	90,000	18,000	0,39	1-NR	NTN
6011NR	55,000	90,000	18,000	0,39	1-NR	NTN
6011NREE	55,000	90,000	18,000	0,41	1-NR	SNR
6011Z	55,000	90,000	18,000	0,38	1	NTN-SNR
6011ZNR	55,000	90,000	18,000	0,39	1-NR	NTN
6011ZZ	55,000	90,000	18,000	0,39	1	NTN-SNR
6011ZZNR	55,000	90,000	18,000	0,40	1-NR	NTN
6012	60,000	95,000	18,000	0,42	1	NTN-SNR
6012D2	60,000	95,000	36,000	0,83	1	NTN
6012E	60,000	95,000	18,000	0,43	1	SNR
6012EE	60,000	95,000	18,000	0,42	1	SNR
6012LB	60,000	95,000	18,000	0,40	1	NTN
6012LLB	60,000	95,000	18,000	0,41	1	NTN
6012LLBNR	60,000	95,000	18,000	0,43	1-NR	NTN
6012LLU	60,000	95,000	18,000	0,41	1	NTN
6012LLUNR	60,000	95,000	18,000	0,43	1-NR	NTN
6012LU	60,000	95,000	18,000	0,40	1	NTN
6012LUZ	60,000	95,000	18,000	0,41	1	NTN
6012N	60,000	95,000	18,000	0,40	1-NR	NTN
6012NR	60,000	95,000	18,000	0,40	1-NR	NTN
6012Z	60,000	95,000	18,000	0,40	1	NTN-SNR
6012ZNR	60,000	95,000	18,000	0,42	1-NR	NTN
6012ZZ	60,000	95,000	18,000	0,41	1	NTN-SNR
6012ZZNR	60,000	95,000	18,000	0,43	1-NR	NTN

Reference	d	D	B	Kg		Brands
6013	65,000	100,000	18,000	0,42	1	NTN-SNR
6013D2	65,000	100,000	36,000	0,88	1	NTN
6013E	65,000	100,000	18,000	0,45	1	SNR
6013EE	65,000	100,000	18,000	0,44	1	SNR
6013FT150	65,000	100,000	18,000	0,45	1	SNR
6013LB	65,000	100,000	18,000	0,43	1	NTN
6013LLB	65,000	100,000	18,000	0,44	1	NTN
6013LLBNR	65,000	100,000	18,000	0,46	1-NR	NTN
6013LLHA	65,000	100,000	18,000	0,44	1	NTN
6013LLU	65,000	100,000	18,000	0,44	1	NTN
6013LU	65,000	100,000	18,000	0,43	1	NTN
6013NR	65,000	100,000	18,000	0,46	1-NR	NTN-SNR
6013NRZ	65,000	100,000	18,000	0,44	1-NR	SNR
6013Z	65,000	100,000	18,000	0,43	1	NTN-SNR
6013ZNR	65,000	100,000	18,000	0,44	1-NR	NTN
6013ZZ	65,000	100,000	18,000	0,44	1	NTN-SNR
6013ZZNR	65,000	100,000	18,000	0,46	1-NR	NTN
6014	70,000	110,000	20,000	0,61	1	NTN-SNR
6014EE	70,000	110,000	20,000	0,63	1	SNR
6014LB	70,000	110,000	20,000	0,60	1	NTN
6014LLB	70,000	110,000	20,000	0,62	1	NTN
6014LLU	70,000	110,000	20,000	0,61	1	NTN
6014LU	70,000	110,000	20,000	0,59	1	NTN
6014NR	70,000	110,000	20,000	0,63	1-NR	NTN-SNR
6014NREE	70,000	110,000	20,000	0,64	1-NR	SNR
6014Z	70,000	110,000	20,000	0,60	1	NTN-SNR
6014ZNR	70,000	110,000	20,000	0,61	1-NR	NTN
6014ZZ	70,000	110,000	20,000	0,61	1	NTN-SNR
6014ZZNR	70,000	110,000	20,000	0,63	1-NR	NTN
6015	75,000	115,000	20,000	0,65	1	NTN-SNR
6015E	75,000	115,000	20,000	0,66	1	SNR
6015EE	75,000	115,000	20,000	0,65	1	SNR
6015LB	75,000	115,000	20,000	0,63	1	NTN
6015LLB	75,000	115,000	20,000	0,65	1	NTN
6015LLU	75,000	115,000	20,000	0,65	1	NTN
6015LU	75,000	115,000	20,000	0,63	1	NTN
6015NR	75,000	115,000	20,000	0,67	1-NR	NTN
6015Z	75,000	115,000	20,000	0,63	1	NTN-SNR
6015ZNR	75,000	115,000	20,000	0,65	1-NR	NTN
6015ZZ	75,000	115,000	20,000	0,65	1	NTN-SNR
6015ZZNR	75,000	115,000	20,000	0,66	1-NR	NTN
6016	80,000	125,000	22,000	0,85	1	NTN-SNR
6016EE	80,000	125,000	22,000	0,86	1	SNR
6016LB	80,000	125,000	22,000	0,83	1	NTN
6016LLB	80,000	125,000	22,000	0,86	1	NTN
6016LLU	80,000	125,000	22,000	0,86	1	NTN
6016LU	80,000	125,000	22,000	0,83	1	NTN
6016N	80,000	125,000	22,000	0,85	1-NR	NTN
6016NR	80,000	125,000	22,000	0,89	1-NR	NTN
6016Z	80,000	125,000	22,000	0,83	1	NTN
6016ZNR	80,000	125,000	22,000	0,87	1-NR	NTN
6016ZZ	80,000	125,000	22,000	0,86	1	NTN-SNR
6016ZZNR	80,000	125,000	22,000	0,89	1-NR	NTN
6017	85,000	130,000	22,000	0,89	1	NTN-SNR
6017EE	85,000	130,000	22,000	0,90	1	SNR
6017K	85,000	130,000	22,000	0,88	1	NTN
6017LLB	85,000	130,000	22,000	0,91	1	NTN
6017LLU	85,000	130,000	22,000	0,91	1	NTN

Reference	d	D	B	Kg		Brands
6017LU	85,000	130,000	22,000	0,87	1	NTN
6017NR	85,000	130,000	22,000	0,93	1-NR	NTN
6017NRZZ	85,000	130,000	22,000	0,97	1-NR	SNR
6017Z	85,000	130,000	22,000	0,88	1	NTN-SNR
6017ZNR	85,000	130,000	22,000	0,91	1-NR	NTN
6017ZZ	85,000	130,000	22,000	0,91	1	NTN-SNR
6017ZZNR	85,000	130,000	22,000	0,94	1-NR	NTN
6018	90,000	140,000	24,000	1,17	1	NTN-SNR
6018EE	90,000	140,000	24,000	1,15	1	SNR
6018LB	90,000	140,000	24,000	1,13	1	NTN
6018LLB	90,000	140,000	24,000	1,17	1	NTN
6018LLU	90,000	140,000	24,000	1,17	1	NTN
6018LLUNR	90,000	140,000	24,000	1,02	1-NR	NTN
6018LU	90,000	140,000	24,000	1,13	1	NTN
6018NR	90,000	140,000	24,000	1,17	1-NR	NTN-SNR
6018NREE	90,000	140,000	24,000	1,18	1-NR	SNR
6018Z	90,000	140,000	24,000	1,13	1	NTN
6018ZNR	90,000	140,000	24,000	1,17	1-NR	NTN
6018ZZ	90,000	140,000	24,000	1,17	1	NTN-SNR
6018ZZNR	90,000	140,000	24,000	1,21	1-NR	NTN
6019	95,000	145,000	24,000	1,08	1	NTN-SNR
6019EE	95,000	145,000	24,000	1,22	1	SNR
6019LLB	95,000	145,000	24,000	1,22	1	NTN
6019LLU	95,000	145,000	24,000	1,22	1	NTN
6019LU	95,000	145,000	24,000	1,18	1	NTN
6019NR	95,000	145,000	24,000	1,27	1-NR	NTN
6019Z	95,000	145,000	24,000	1,18	1	NTN
6019ZNR	95,000	145,000	24,000	1,22	1-NR	NTN
6019ZZ	95,000	145,000	24,000	1,20	1	NTN-SNR
6019ZZNR	95,000	145,000	24,000	1,22	1-NR	NTN
602	2,000	7,000	2,800	0,001	1	NTN
6020	100,000	150,000	24,000	1,27	1	NTN-SNR
6020EE	100,000	150,000	24,000	1,28	1	SNR
6020LLB	100,000	150,000	24,000	1,26	1	NTN
6020LLU	100,000	150,000	24,000	1,26	1	NTN
6020LU	100,000	150,000	24,000	1,23	1	NTN
6020NR	100,000	150,000	24,000	1,31	1-NR	NTN-SNR
6020Z	100,000	150,000	24,000	1,23	1	NTN
6020ZNR	100,000	150,000	24,000	1,27	1-NR	NTN
6020ZZ	100,000	150,000	24,000	1,26	1	NTN-SNR
6020ZZNR	100,000	150,000	24,000	1,30	1-NR	NTN
6021	105,000	160,000	26,000	1,58	1	NTN-SNR
6021EE	105,000	160,000	26,000	1,61	1	SNR
6021LLB	105,000	160,000	26,000	1,60	1	NTN
6021LLU	105,000	160,000	26,000	1,59	1	NTN
6021LU	105,000	160,000	26,000	1,59	1	NTN
6021Z	105,000	160,000	26,000	1,59	1	NTN
6021ZZ	105,000	160,000	26,000	1,60	1	NTN
6021ZZNR	105,000	160,000	26,000	1,64	1-NR	NTN
6022	110,000	170,000	28,000	1,96	1	NTN-SNR
6022EE	110,000	170,000	28,000	2,03	1	SNR
6022K	110,000	170,000	28,000	1,96	1	NTN
6022LLB	110,000	170,000	28,000	1,98	1	NTN
6022LLU	110,000	170,000	28,000	1,98	1	NTN
6022LU	110,000	170,000	28,000	1,96	1	NTN
6022NR	110,000	170,000	28,000	2,04	1-NR	NTN
6022Z	110,000	170,000	28,000	1,94	1	NTN

Reference	d	D	B	Kg		Brands
6022ZNR	110,000	170,000	28,000	2,05	1-NR	NTN
6022ZZ	110,000	170,000	28,000	1,98	1	NTN
6022ZZNR	110,000	170,000	28,000	2,06	1-NR	NTN
6024	120,000	180,000	28,000	2,10	1	NTN-SNR
6024E	120,000	180,000	28,000	2,19	1	SNR
6024EE	120,000	180,000	28,000	2,15	1	SNR
6024LLB	120,000	180,000	28,000	2,03	1	NTN
6024LLU	120,000	180,000	28,000	2,13	1	NTN
6024LU	120,000	180,000	28,000	2,11	1	NTN
6024NR	120,000	180,000	28,000	2,16	1-NR	NTN-SNR
6024Z	120,000	180,000	28,000	2,10	1	NTN
6024ZZ	120,000	180,000	28,000	2,12	1	NTN
6024ZZNR	120,000	180,000	28,000	2,20	1-NR	NTN
6026	130,000	200,000	33,000	3,16	1	NTN-SNR
6026LLB	130,000	200,000	33,000	3,19	1	NTN
6026LLU	130,000	200,000	33,000	3,28	1	NTN
6026NR	130,000	200,000	33,000	3,19	1-NR	NTN
6026Z	130,000	200,000	33,000	3,19	1	NTN
6026ZZ	130,000	200,000	33,000	3,27	1	NTN
6026ZZNR	130,000	200,000	33,000	3,26	1-NR	NTN
6028	140,000	210,000	33,000	3,49	1	NTN-SNR
6028EE	140,000	210,000	33,000	3,62	1	SNR
6028LLU	140,000	210,000	33,000	3,49	1	NTN
6028LU	140,000	210,000	33,000	3,35	1	NTN
6028Z	140,000	210,000	33,000	3,30	1	NTN
6028ZZ	140,000	210,000	33,000	3,48	1	NTN
603	3,000	9,000	3,000	0,001	1	NTN
6030	150,000	225,000	35,000	4,08	1	NTN-SNR
6030LLB	150,000	225,000	35,000	4,15	1	NTN
6030LLU	150,000	225,000	35,000	4,26	1	NTN
6030Z	150,000	225,000	35,000	4,22	1	NTN
6030ZZ	150,000	225,000	35,000	4,16	1	NTN
6032	160,000	240,000	38,000	5,19	1	NTN
6032EE	160,000	240,000	38,000	5,35	1	SNR
6032LLU	160,000	240,000	38,000	5,26	1	NTN
6032M	160,000	240,000	38,000	6,10	1	SNR
6032Z	160,000	240,000	38,000	5,20	1	NTN
6032ZZ	160,000	240,000	38,000	5,24	1	NTN
6034	170,000	260,000	42,000	6,76	1	NTN
6034M	170,000	260,000	42,000	8,20	1	SNR
6034Z	170,000	260,000	42,000	6,96	1	NTN
6034ZZ	170,000	260,000	42,000	7,06	1	NTN
6036	180,000	280,000	46,000	8,80	1	NTN
6036/1803	180,300	280,000	46,000	9,10	1	NTN
6036LLU	180,000	280,000	46,000	9,23	1	NTN
6036M	180,000	280,000	46,000	10,60	1	SNR
6036Z	180,000	280,000	46,000	9,03	1	NTN
6036ZZ	180,000	280,000	46,000	9,10	1	NTN
6038	190,000	290,000	46,000	9,18	1	NTN
6038M	190,000	290,000	46,000	11,03	1	SNR
6038Z	190,000	290,000	46,000	9,47	1	NTN
6038ZZ	190,000	290,000	46,000	9,56	1	NTN
604	4,000	12,000	4,000	0,002	1	NTN
6040	200,000	310,000	51,000	11,90	1	NTN



Reference	d	D	B	Kg	?	Brands
6040M	200,000	310,000	51,000	14,18	1	SNR
6040Z	200,000	310,000	51,000	12,10	1	NTN
6040ZZ	200,000	310,000	51,000	12,30	1	NTN
6044	220,000	340,000	56,000	15,70	1	NTN
6044Z	220,000	340,000	56,000	16,22	1	NTN
6044ZZ	220,000	340,000	56,000	16,40	1	NTN
6048	240,000	360,000	56,000	16,80	1	NTN
6048D2	240,000	360,000	112,000	33,60	1	NTN
6048Z	240,000	360,000	56,000	17,39	1	NTN
6048ZZ	240,000	360,000	56,000	17,40	1	NTN
604ZZ	4,000	12,000	4,000	0,002	1	NTN
605	5,000	14,000	5,000	0,004	1	NTN
6052	260,000	400,000	65,000	25,00	1	NTN
6056	280,000	420,000	65,000	31,90	1	NTN
605Z	5,000	14,000	5,000	0,003	1	NTN
605ZZ	5,000	14,000	5,000	0,003	1	NTN
606	6,000	17,000	6,000	0,01	1	NTN
6060	300,000	460,000	74,000	43,80	1	NTN
6064	320,000	480,000	74,000	46,24	1	NTN
6068	340,000	520,000	82,000	61,80	1	NTN
606LLH	6,000	17,000	6,000	0,01	1	NTN
606Z	6,000	17,000	6,000	0,01	1	NTN
606ZZ	6,000	17,000	6,000	0,01	1	NTN
607	7,000	19,000	6,000	0,01	1	NTN-SNR
6072	360,000	540,000	82,000	65,80	1	NTN
6076	380,000	560,000	82,000	67,50	1	NTN
607EE	7,000	19,000	6,000	0,01	1	SNR
607LB	7,000	19,000	6,000	0,01	1	NTN
607LLB	7,000	19,000	6,000	0,01	1	NTN
607LLU	7,000	19,000	6,000	0,01	1	NTN
607Z	7,000	19,000	6,000	0,01	1	NTN-SNR
607ZZ	7,000	19,000	6,000	0,01	1	NTN-SNR
607ZZD2	7,000	19,000	12,000	0,02	1	NTN
608	8,000	22,000	7,000	0,01	1	NTN-SNR
608/560	560,000	680,000	37,000	44,16	1	NTN
6080	400,000	600,000	90,000	87,60	1	NTN
6084	420,000	620,000	90,000	91,10	1	NTN
6088	440,000	650,000	94,000	104,00	1	NTN
6088/450	450,000	650,000	94,000	99,70	1	NTN
608EE	8,000	22,000	7,000	0,01	1	SNR
608FT150	8,000	22,000	7,000	0,02	1	SNR
608LB	8,000	22,000	7,000	0,01	1	NTN
608LLB	8,000	22,000	7,000	0,01	1	NTN
608LLH	8,000	22,000	7,000	0,01	1	NTN
608LLU	8,000	22,000	7,000	0,01	1	NTN
608LU	8,000	22,000	7,000	0,01	1	NTN
608Z	8,000	22,000	7,000	0,01	1	NTN-SNR
608ZZ	8,000	22,000	7,000	0,01	1	NTN-SNR
609	9,000	24,000	7,000	0,01	1	NTN-SNR
6092	460,000	680,000	100,000	122,00	1	NTN
6096	480,000	700,000	100,000	126,00	1	NTN

Reference	d	D	B	Kg	?	Brands
609EE	9,000	24,000	7,000	0,02	1	SNR
609J	9,000	24,000	7,000	0,01	1	NTN
609JLLB	9,000	24,000	7,000	0,02	1	NTN
609JX2	9,000	24,000	7,000	0,01	1	NTN
609JX2LLU	9,000	24,000	7,000	0,02	1	NTN
609JX2LUZ	9,000	24,000	7,000	0,01	1	NTN
609JX2Z	9,000	24,000	7,000	0,01	1	NTN
609LLU	9,000	24,000	7,000	0,02	1	NTN
609Z	9,000	24,000	7,000	0,02	1	SNR
609ZZ	9,000	24,000	7,000	0,02	1	SNR
62/22	22,000	50,000	14,000	0,12	1	NTN
62/22C	22,000	50,000	14,000	0,12	1	NTN
62/22LB	22,000	50,000	14,000	0,12	1	NTN
62/22LLB	22,000	50,000	14,000	0,11	1	NTN
62/22LLH	22,000	50,000	14,000	0,12	1	NTN
62/22LLU	22,000	50,000	14,000	0,12	1	NTN
62/22LU	22,000	50,000	14,000	0,12	1	NTN
62/22N	22,000	50,000	14,000	0,12	1-NR	NTN
62/22NR	22,000	50,000	14,000	0,12	1-NR	NTN
62/22ZZ	22,000	50,000	14,000	0,11	1	NTN
62/22ZZNR	22,000	50,000	14,000	0,11	1-NR	NTN
62/28	28,000	58,000	16,000	0,17	1	NTN
62/28/25	25,000	58,000	16,000	0,18	1	NTN
62/28LLB	28,000	58,000	16,000	0,17	1	NTN
62/28LLH	28,000	58,000	16,000	0,17	1	NTN
62/28LLU	28,000	58,000	16,000	0,17	1	NTN
62/28LLUNR	28,000	58,000	16,000	0,17	1-NR	NTN
62/28LU	28,000	58,000	16,000	0,17	1	NTN
62/28NR	28,000	58,000	16,000	0,17	1-NR	NTN
62/28ZZ	28,000	58,000	16,000	0,17	1	NTN
62/28ZZNR	28,000	58,000	16,000	0,17	1-NR	NTN
62/32	32,000	65,000	17,000	0,23	1	NTN
62/32LLU	32,000	65,000	17,000	0,22	1	NTN
62/32NR	32,000	65,000	17,000	0,23	1-NR	NTN
62/32ZNR	32,000	65,000	17,000	0,23	1-NR	NTN
62/32ZZ	32,000	65,000	17,000	0,23	1	NTN
6200	10,000	30,000	9,000	0,03	1	NTN-SNR
6200EE	10,000	30,000	9,000	0,03	1	SNR
6200FT150	10,000	30,000	9,000	0,03	1	SNR
6200FT150ZZ	10,000	30,000	9,000	0,03	1	SNR
6200LB	10,000	30,000	9,000	0,03	1	NTN
6200LLB	10,000	30,000	9,000	0,03	1	NTN
6200LLBNR	10,000	30,000	9,000	0,03	1-NR	NTN
6200LLH	10,000	30,000	9,000	0,03	1	NTN
6200LLU	10,000	30,000	9,000	0,03	1	NTN
6200LLUNR	10,000	30,000	9,000	0,03	1-NR	NTN
6200LT	10,000	30,000	9,000	0,05	1	SNR
6200LTZZ	10,000	30,000	9,000	0,04	1	SNR
6200LU	10,000	30,000	9,000	0,03	1	NTN
6200NRZZ	10,000	30,000	9,000	0,04	1-NR	SNR
6200Z	10,000	30,000	9,000	0,03	1	NTN-SNR
6200ZNR	10,000	30,000	9,000	0,03	1-NR	NTN
6200ZZ	10,000	30,000	9,000	0,03	1	NTN-SNR
6200ZZNR	10,000	30,000	9,000	0,03	1-NR	NTN
6201	12,000	32,000	10,000	0,04	1	NTN-SNR
6201E	12,000	32,000	10,000	0,04	1	SNR
6201EE	12,000	32,000	10,000	0,04	1	SNR

Reference	d	D	B	Kg	Brands
6201FT150	12,000	32,000	10,000	0,04	1 SNR
6201FT150ZZ	12,000	32,000	10,000	0,04	1 SNR
6201HT200ZZ	12,000	32,000	10,000	0,04	1 SNR
6201HVZZ	12,000	32,000	10,000	0,04	1 SNR
6201LB	12,000	32,000	10,000	0,04	1 NTN
6201LLB	12,000	32,000	10,000	0,04	1 NTN
6201LLB/127	12,700	32,000	10,000	0,04	1 NTN
6201LLBD2	12,000	32,000	20,000	0,07	1 NTN
6201LLBNR	12,000	32,000	10,000	0,04	1-NR NTN
6201LLH	12,000	32,000	10,000	0,04	1 NTN
6201LLHN	12,000	32,000	10,000	0,04	1-NR NTN
6201LLHNR	12,000	32,000	10,000	0,04	1-NR NTN
6201LLU	12,000	32,000	10,000	0,04	1 NTN
6201LLUNR	12,000	32,000	10,000	0,04	1-NR NTN
6201LT	12,000	32,000	10,000	0,04	1 SNR
6201LTZZ	12,000	32,000	10,000	0,04	1 SNR
6201LU	12,000	32,000	10,000	0,04	1 NTN
6201NR	12,000	32,000	10,000	0,04	1-NR NTN
6201NRZZ	12,000	32,000	10,000	0,04	1-NR SNR
6201Z	12,000	32,000	10,000	0,04	1 NTN-SNR
6201ZNR	12,000	32,000	10,000	0,04	1-NR NTN
6201ZZ	12,000	32,000	10,000	0,04	1 NTN-SNR
6201ZZN	12,000	32,000	10,000	0,04	1-NR NTN
6201ZZNR	12,000	32,000	10,000	0,04	1-NR NTN
6202	15,000	35,000	11,000	0,04	1 NTN-SNR
6202E	15,000	35,000	11,000	0,05	1 SNR
6202EE	15,000	35,000	11,000	0,05	1 SNR
6202FT150	15,000	35,000	11,000	0,05	1 SNR
6202FT150ZZ	15,000	35,000	11,000	0,05	1 SNR
6202HT200ZZ	15,000	35,000	11,000	0,05	1 SNR
6202HVZZ	15,000	35,000	11,000	0,05	1 SNR
6202LB	15,000	35,000	11,000	0,04	1 NTN
6202LLB	15,000	35,000	11,000	0,04	1 NTN
6202LLBNR	15,000	35,000	11,000	0,04	1-NR NTN
6202LLH	15,000	35,000	11,000	0,04	1 NTN
6202LLU	15,000	35,000	11,000	0,04	1 NTN
6202LLU/15875	15,875	35,000	11,000	0,04	1 NTN
6202LLUNR	15,000	35,000	11,000	0,05	1-NR NTN
6202LT	15,000	35,000	11,000	0,05	1 SNR
6202LTZZ	15,000	35,000	11,000	0,05	1 SNR
6202LU	15,000	35,000	11,000	0,04	1 NTN
6202NR	15,000	35,000	11,000	0,05	1-NR NTN-SNR
6202NREE	15,000	35,000	11,000	0,05	1-NR SNR
6202NRZZ	15,000	35,000	11,000	0,05	1-NR SNR
6202Z	15,000	35,000	11,000	0,04	1 NTN-SNR
6202ZG15B	15,000	35,000	11,000	0,05	1 SNR
6202ZNR	15,000	35,000	11,000	0,05	1-NR NTN
6202ZZ	15,000	35,000	11,000	0,04	1 NTN-SNR
6202ZZG15	15,000	35,000	11,000	0,04	1 SNR
6202ZZNR	15,000	35,000	11,000	0,05	1-NR NTN
6203	17,000	40,000	12,000	0,07	1 NTN-SNR
6203E	17,000	40,000	12,000	0,07	1 SNR
6203EE	17,000	40,000	12,000	0,07	1 SNR
6203FT150	17,000	40,000	12,000	0,07	1 SNR
6203FT150ZZ	17,000	40,000	12,000	0,07	1 SNR
6203G15	17,000	40,000	12,000	0,07	1 SNR
6203HT200ZZ	17,000	40,000	12,000	0,07	1 SNR
6203HVZZ	17,000	40,000	12,000	0,07	1 SNR
6203LB	17,000	40,000	12,000	0,06	1 NTN
6203LLB	17,000	40,000	12,000	0,06	1 NTN

Reference	d	D	B	Kg	Brands
6203LLBNR	17,000	40,000	12,000	0,07	1-NR NTN
6203LLH	17,000	40,000	12,000	0,06	1 NTN
6203LLU	17,000	40,000	12,000	0,06	1 NTN
6203LLU/15	15,000	40,000	12,000	0,07	1 NTN
6203LLU/15875	15,875	40,000	12,000	0,07	1 NTN
6203LLUNR	17,000	40,000	12,000	0,06	1-NR NTN
6203LT	17,000	40,000	12,000	0,07	1 SNR
6203LTZZ	17,000	40,000	12,000	0,07	1 SNR
6203LU	17,000	40,000	12,000	0,06	1 NTN
6203LUZ	17,000	40,000	12,000	0,06	1 NTN
6203N	17,000	40,000	12,000	0,07	1-NR NTN
6203NR	17,000	40,000	12,000	0,07	1-NR NTN-SNR
6203NREE	17,000	40,000	12,000	0,08	1-NR SNR
6203NRZZ	17,000	40,000	12,000	0,07	1-NR SNR
6203NZ	17,000	40,000	12,000	0,07	1-NR SNR
6203SEE	17,000	40,000	12,000	0,07	1 SNR
6203Z	17,000	40,000	12,000	0,06	1 NTN-SNR
6203ZNR	17,000	40,000	12,000	0,06	1-NR NTN
6203ZZ	17,000	40,000	12,000	0,06	1 NTN-SNR
6203ZZG15	17,000	40,000	12,000	0,07	1 SNR
6203ZZNR	17,000	40,000	12,000	0,07	1-NR NTN
6204	20,000	47,000	14,000	0,11	1 NTN-SNR
6204/22	22,000	47,000	14,000	0,10	1 NTN
6204C	20,000	47,000	14,000	0,11	1 NTN
6204E	20,000	47,000	14,000	0,11	1 SNR
6204EE	20,000	47,000	14,000	0,11	1 SNR
6204F600	20,000	47,000	14,000	0,11	1 SNR
6204F604	20,000	47,000	14,000	0,11	1 SNR
6204F605	20,000	47,000	14,000	0,11	1 SNR
6204FT150	20,000	47,000	14,000	0,11	1 SNR
6204FT150ZZ	20,000	47,000	14,000	0,11	1 SNR
6204G15	20,000	47,000	14,000	0,10	1 SNR
6204HT200	20,000	47,000	14,000	0,11	1 SNR
6204HT200ZZ	20,000	47,000	14,000	0,10	1 SNR
6204HVZZ	20,000	47,000	14,000	0,10	1 SNR
6204LB	20,000	47,000	14,000	0,10	1 NTN
6204LLB	20,000	47,000	14,000	0,10	1 NTN
6204LLBNR	20,000	47,000	14,000	0,10	1-NR NTN
6204LLH	20,000	47,000	14,000	0,10	1 NTN
6204LLU	20,000	47,000	14,000	0,10	1 NTN
6204LLU/22	22,000	47,000	14,000	0,10	1 NTN
6204LLUN	20,000	47,000	14,000	0,10	1-NR NTN
6204LLUNR	20,000	47,000	14,000	0,11	1-NR NTN
6204LT	20,000	47,000	14,000	0,11	1 SNR
6204LTZZ	20,000	47,000	14,000	0,11	1 SNR
6204LU	20,000	47,000	14,000	0,10	1 NTN
6204N	20,000	47,000	14,000	0,10	1-NR SNR
6204NR	20,000	47,000	14,000	0,11	1-NR NTN-SNR
6204NREE	20,000	47,000	14,000	0,11	1-NR SNR
6204NRZZ	20,000	47,000	14,000	0,11	1-NR SNR
6204SEE	20,000	47,000	14,000	0,13	1 SNR
6204Z	20,000	47,000	14,000	0,10	1 NTN-SNR
6204ZNR	20,000	47,000	14,000	0,10	1-NR NTN
6204ZZ	20,000	47,000	14,000	0,10	1 NTN-SNR
6204ZZNR	20,000	47,000	14,000	0,10	1-NR NTN
6205	25,000	52,000	15,000	0,13	1 NTN-SNR
6205/254	25,400	52,000	15,000	0,12	1 NTN
6205/26	26,000	52,000	15,000	0,11	1 NTN
6205/27	27,000	52,000	15,000	0,12	1 NTN
6205C	25,000	52,000	15,000	0,13	1 NTN



Reference	d	D	B	Kg	?	Brands
6205E	25,000	52,000	15,000	0,13	1	SNR
6205EE	25,000	52,000	15,000	0,14	1	SNR
6205F600	25,000	52,000	15,000	0,13	1	SNR
6205F604	25,000	52,000	15,000	0,13	1	SNR
6205FT150	25,000	52,000	15,000	0,14	1	SNR
6205FT150ZZ	25,000	52,000	15,000	0,14	1	SNR
6205G15	25,000	52,000	15,000	0,13	1	SNR
6205HT200	25,000	52,000	15,000	0,14	1	SNR
6205HT200ZZ	25,000	52,000	15,000	0,14	1	SNR
6205HVZZ	25,000	52,000	15,000	0,13	1	SNR
6205KEE	25,000	52,000	15,000	0,13	1	SNR
6205LB	25,000	52,000	15,000	0,12	1	NTN
6205LBU	25,000	52,000	15,000	0,12	1	NTN
6205LLB	25,000	52,000	15,000	0,12	1	NTN
6205LLBNR	25,000	52,000	15,000	0,13	1-NR	NTN
6205LLH	25,000	52,000	15,000	0,12	1	NTN
6205LLU	25,000	52,000	15,000	0,13	1	NTN
6205LLUN	25,000	52,000	15,000	0,12	1-NR	NTN
6205LLUNR	25,000	52,000	15,000	0,13	1-NR	NTN
6205LT	25,000	52,000	15,000	0,14	1	SNR
6205LTZZ	25,000	52,000	15,000	0,14	1	SNR
6205LU	25,000	52,000	15,000	0,12	1	NTN
6205LUZ	25,000	52,000	15,000	0,13	1	NTN
6205N	25,000	52,000	15,000	0,13	1-NR	NTN-SNR
6205NEE	25,000	52,000	15,000	0,13	1-NR	SNR
6205NR	25,000	52,000	15,000	0,13	1-NR	NTN-SNR
6205NREE	25,000	52,000	15,000	0,14	1-NR	SNR
6205NRZ	25,000	52,000	15,000	0,14	1-NR	SNR
6205NRZZ	25,000	52,000	15,000	0,13	1-NR	SNR
6205Z	25,000	52,000	15,000	0,12	1	NTN-SNR
6205ZNR	25,000	52,000	15,000	0,13	1-NR	NTN
6205ZZ	25,000	52,000	15,000	0,12	1	NTN-SNR
6205ZZN	25,000	52,000	15,000	0,13	1-NR	NTN
6205ZZNR	25,000	52,000	15,000	0,13	1-NR	NTN
6206	30,000	62,000	16,000	0,19	1	NTN-SNR
6206/25	25,000	62,000	16,000	0,22	1	NTN
6206C	30,000	62,000	16,000	0,20	1	NTN
6206D2	30,000	62,000	32,000	0,39	1	NTN
6206E	30,000	62,000	16,000	0,20	1	SNR
6206EE	30,000	62,000	16,000	0,20	1	SNR
6206F600	30,000	62,000	16,000	0,20	1	SNR
6206F604	30,000	62,000	16,000	0,20	1	SNR
6206FT150	30,000	62,000	16,000	0,20	1	SNR
6206FT150ZZ	30,000	62,000	16,000	0,21	1	SNR
6206G15	30,000	62,000	16,000	0,19	1	SNR
6206HT200	30,000	62,000	16,000	0,21	1	SNR
6206HT200ZZ	30,000	62,000	16,000	0,21	1	SNR
6206HVZZ	30,000	62,000	16,000	0,20	1	SNR
6206KEE	30,000	62,000	16,000	0,20	1	SNR
6206KZZ	30,000	62,000	16,000	0,20	1	SNR
6206LB	30,000	62,000	16,000	0,20	1	NTN
6206LLB	30,000	62,000	16,000	0,02	1	NTN
6206LLBNR	30,000	62,000	16,000	0,20	1-NR	NTN
6206LLH	30,000	62,000	16,000	0,17	1	NTN
6206LLHN	30,000	62,000	16,000	0,19	1-NR	NTN
6206LLU	30,000	62,000	16,000	0,17	1	NTN
6206LLUN	30,000	62,000	16,000	0,19	1-NR	NTN
6206LLUNR	30,000	62,000	16,000	0,20	1-NR	NTN
6206LT	30,000	62,000	16,000	0,20	1	SNR
6206LTZZ	30,000	62,000	16,000	0,20	1	SNR
6206LU	30,000	62,000	16,000	0,20	1	NTN

Reference	d	D	B	Kg	?	Brands
6206LUA/28	28,000	62,000	16,000	0,20	1	NTN
6206LUD2	30,000	62,000	32,000	0,39	1	NTN
6206N	30,000	62,000	16,000	0,19	1-NR	NTN-SNR
6206NEE	30,000	62,000	16,000	0,20	1-NR	SNR
6206NR	30,000	62,000	16,000	0,20	1-NR	NTN-SNR
6206NREE	30,000	62,000	16,000	0,21	1-NR	SNR
6206NRZ	30,000	62,000	16,000	0,20	1-NR	SNR
6206NRZZ	30,000	62,000	16,000	0,21	1-NR	SNR
6206Z	30,000	62,000	16,000	0,19	1	NTN-SNR
6206ZNR	30,000	62,000	16,000	0,20	1-NR	NTN
6206ZZ	30,000	62,000	16,000	0,17	1	NTN-SNR
6206ZZNR	30,000	62,000	16,000	0,17	1-NR	NTN
6207	35,000	72,000	17,000	0,29	1	NTN-SNR
6207/31	31,000	72,000	17,000	0,32	1	NTN
6207/33	33,000	72,000	17,000	0,30	1	NTN
6207C	35,000	72,000	17,000	0,27	1	NTN
6207CZ	35,000	72,000	17,000	0,28	1	NTN
6207D2	35,000	72,000	34,000	0,57	1	NTN
6207E	35,000	72,000	17,000	0,29	1	SNR
6207EE	35,000	72,000	17,000	0,30	1	SNR
6207F600	35,000	72,000	17,000	0,28	1	SNR
6207F604	35,000	72,000	17,000	0,30	1	SNR
6207F605	35,000	72,000	17,000	0,29	1	SNR
6207FT150	35,000	72,000	17,000	0,30	1	SNR
6207FT150ZZ	35,000	72,000	17,000	0,30	1	SNR
6207HT200	35,000	72,000	17,000	0,29	1	SNR
6207HT200ZZ	35,000	72,000	17,000	0,29	1	SNR
6207HVZZ	35,000	72,000	17,000	0,28	1	SNR
6207LB	35,000	72,000	17,000	0,29	1	NTN
6207LLB	35,000	72,000	17,000	0,27	1	NTN
6207LLBNR	35,000	72,000	17,000	0,29	1-NR	NTN
6207LLH	35,000	72,000	17,000	0,29	1	NTN
6207LLU	35,000	62,000	14,000	0,29	1	NTN
6207LLUNR	35,000	72,000	17,000	0,29	1-NR	NTN
6207LU	35,000	72,000	17,000	0,28	1	NTN
6207N	35,000	72,000	17,000	0,28	1-NR	NTN-SNR
6207NEE	35,000	72,000	17,000	0,29	1-NR	SNR
6207NR	35,000	72,000	17,000	0,29	1-NR	NTN-SNR
6207NREE	35,000	72,000	17,000	0,29	1-NR	SNR
6207NRZ	35,000	72,000	17,000	0,29	1-NR	SNR
6207NRZZ	35,000	72,000	17,000	0,31	1-NR	SNR
6207Z	35,000	72,000	17,000	0,28	1	NTN-SNR
6207ZNR	35,000	72,000	17,000	0,28	1-NR	NTN
6207ZZ	35,000	72,000	17,000	0,27	1	NTN-SNR
6207ZZNR	35,000	72,000	17,000	0,29	1-NR	NTN
6208	40,000	80,000	18,000	0,36	1	NTN-SNR
6208D2	40,000	80,000	36,000	0,73	1	NTN
6208E	40,000	80,000	18,000	0,42	1	SNR
6208EE	40,000	80,000	18,000	0,38	1	SNR
6208F600	40,000	80,000	18,000	0,35	1	SNR
6208F604	40,000	80,000	18,000	0,36	1	SNR
6208F605	40,000	80,000	18,000	0,35	1	SNR
6208FT150	40,000	80,000	18,000	0,38	1	SNR
6208FT150ZZ	40,000	80,000	18,000	0,36	1	SNR
6208HT200	40,000	80,000	18,000	0,37	1	SNR
6208HT200ZZ	40,000	80,000	18,000	0,38	1	SNR
6208HVZZ	40,000	80,000	18,000	0,35	1	SNR
6208KEE	40,000	80,000	18,000	0,37	1	SNR
6208LB	40,000	80,000	18,000	0,36	1	NTN
6208LH	40,000	80,000	18,000	0,36	1	NTN

Reference	d	D	B	Kg		Brands
6208LHA	40,000	80,000	18,000	0,36	1	NTN
6208LLB	40,000	80,000	18,000	0,37	1	NTN
6208LLBNR	40,000	80,000	18,000	0,38	1-NR	NTN
6208LLH	40,000	80,000	18,000	0,37	1	NTN
6208LLU	40,000	80,000	18,000	0,36	1	NTN
6208LLUD2	40,000	80,000	36,000	0,74	1	NTN
6208LLUK	40,000	80,000	18,000	0,36	1	NTN
6208LLUN	40,000	80,000	18,000	0,36	1-NR	NTN
6208LLUNR	40,000	80,000	18,000	0,36	1-NR	NTN
6208LU	40,000	80,000	18,000	0,36	1	NTN
6208N	40,000	80,000	18,000	0,36	1-NR	NTN-SNR
6208NR	40,000	80,000	18,000	0,37	1-NR	NTN-SNR
6208NREE	40,000	80,000	18,000	0,39	1-NR	SNR
6208NRZ	40,000	80,000	18,000	0,38	1-NR	SNR
6208NRZZ	40,000	80,000	18,000	0,39	1-NR	SNR
6208Z	40,000	80,000	18,000	0,36	1	NTN-SNR
6208ZNR	40,000	80,000	18,000	0,35	1-NR	NTN
6208ZZ	40,000	80,000	18,000	0,36	1	NTN-SNR
6208ZZD22	40,000	80,000	18,000	0,37	1	SNR
6208ZZNR	40,000	80,000	18,000	0,38	1-NR	NTN
6209	45,000	85,000	19,000	0,40	1	NTN-SNR
6209E	45,000	85,000	19,000	0,42	1	SNR
6209EE	45,000	85,000	19,000	0,41	1	SNR
6209F604	45,000	85,000	19,000	0,41	1	SNR
6209FT150	45,000	85,000	19,000	0,41	1	SNR
6209FT150ZZ	45,000	85,000	19,000	0,43	1	SNR
6209HT200	45,000	85,000	19,000	0,42	1	SNR
6209HT200ZZ	45,000	85,000	19,000	0,42	1	SNR
6209HVZZ	45,000	85,000	19,000	0,41	1	SNR
6209K	45,000	85,000	19,000	0,40	1	SNR
6209KEE	45,000	85,000	19,000	0,40	1	SNR
6209LB	45,000	85,000	19,000	0,39	1	NTN
6209LLB	45,000	85,000	19,000	0,40	1	NTN
6209LLBNR	45,000	85,000	19,000	0,41	1-NR	NTN
6209LLU	45,000	85,000	19,000	0,40	1	NTN
6209LLUD2	45,000	85,000	38,000	0,80	1	NTN
6209LLUNR	45,000	85,000	19,000	0,41	1-NR	NTN
6209LU	45,000	85,000	19,000	0,39	1	NTN
6209N	45,000	85,000	19,000	0,40	1-NR	SNR
6209NR	45,000	85,000	19,000	0,41	1-NR	NTN-SNR
6209NREE	45,000	85,000	19,000	0,43	1-NR	SNR
6209NRZ	45,000	85,000	19,000	0,41	1-NR	SNR
6209NRZZ	45,000	85,000	19,000	0,42	1-NR	SNR
6209SEE	45,000	85,000	19,000	0,41	1	SNR
6209Z	45,000	85,000	19,000	0,39	1	NTN-SNR
6209ZNR	45,000	85,000	19,000	0,40	1-NR	NTN
6209ZZ	45,000	85,000	19,000	0,40	1	NTN-SNR
6209ZZNR	45,000	85,000	19,000	0,41	1-NR	NTN
6210	50,000	90,000	20,000	0,44	1	NTN-SNR
6210E	50,000	90,000	20,000	0,47	1	SNR
6210EE	50,000	90,000	20,000	0,47	1	SNR
6210F600	50,000	90,000	20,000	0,46	1	SNR
6210F604	50,000	90,000	20,000	0,47	1	SNR
6210F605	50,000	90,000	20,000	0,45	1	SNR
6210FT150	50,000	90,000	20,000	0,47	1	SNR
6210FT150ZZ	50,000	90,000	20,000	0,47	1	SNR
6210HT200	50,000	90,000	20,000	0,48	1	SNR
6210HT200ZZ	50,000	90,000	20,000	0,47	1	SNR
6210HVZZ	50,000	90,000	20,000	0,47	1	SNR
6210LB	50,000	90,000	20,000	0,44	1	NTN

Reference	d	D	B	Kg		Brands
6210LBU	50,000	90,000	20,000	0,44	1	NTN
6210LLB	50,000	90,000	20,000	0,44	1	NTN
6210LLBNR	50,000	90,000	20,000	0,48	1-NR	NTN
6210LLU	50,000	90,000	20,000	0,46	1	NTN
6210LLUN	50,000	90,000	20,000	0,45	1-NR	NTN
6210LLUNR	50,000	90,000	20,000	0,47	1-NR	NTN
6210LU	50,000	90,000	20,000	0,44	1	NTN
6210LUNR	50,000	90,000	20,000	0,46	1-NR	NTN
6210N	50,000	90,000	20,000	0,45	1-NR	SNR
6210NR	50,000	90,000	20,000	0,47	1-NR	NTN-SNR
6210NREE	50,000	90,000	20,000	0,50	1-NR	SNR
6210NRZ	50,000	90,000	20,000	0,49	1-NR	SNR
6210NRZZ	50,000	90,000	20,000	0,45	1-NR	SNR
6210Z	50,000	90,000	20,000	0,44	1	NTN-SNR
6210ZNR	50,000	90,000	20,000	0,46	1-NR	NTN
6210ZZ	50,000	90,000	20,000	0,42	1	NTN-SNR
6210ZZNR	50,000	90,000	20,000	0,47	1-NR	NTN
6211	55,000	100,000	21,000	0,60	1	NTN-SNR
6211D2	55,000	100,000	42,000	1,21	1	NTN
6211E	55,000	100,000	21,000	0,62	1	SNR
6211EE	55,000	100,000	21,000	0,63	1	SNR
6211F600	55,000	100,000	21,000	0,58	1	SNR
6211F604	55,000	100,000	21,000	0,61	1	SNR
6211K	55,000	100,000	21,000	0,61	1	SNR
6211KEE	55,000	100,000	21,000	0,61	1	SNR
6211LB	55,000	100,000	21,000	0,59	1	NTN
6211LLB	55,000	100,000	21,000	0,58	1	NTN
6211LLBNR	55,000	100,000	21,000	0,63	1-NR	NTN
6211LLU	55,000	100,000	21,000	0,61	1	NTN
6211LLUNR	55,000	100,000	21,000	0,63	1-NR	NTN
6211LU	55,000	100,000	21,000	0,59	1	NTN
6211N	55,000	100,000	21,000	0,59	1-NR	NTN-SNR
6211NR	55,000	100,000	21,000	0,62	1-NR	NTN-SNR
6211NRZ	55,000	100,000	21,000	0,64	1-NR	SNR
6211NRZZ	55,000	100,000	21,000	0,66	1-NR	SNR
6211Z	55,000	100,000	21,000	0,59	1	NTN-SNR
6211ZNR	55,000	100,000	21,000	0,60	1-NR	NTN
6211ZZ	55,000	100,000	21,000	0,61	1	NTN-SNR
6211ZZNR	55,000	100,000	21,000	0,62	1-NR	NTN
6212	60,000	110,000	22,000	0,74	1	NTN-SNR
6212D2	60,000	110,000	44,000	1,53	1	NTN
6212E	60,000	110,000	22,000	0,78	1	SNR
6212EE	60,000	110,000	22,000	0,79	1	SNR
6212F600	60,000	110,000	22,000	0,76	1	SNR
6212LB	60,000	110,000	22,000	0,75	1	NTN
6212LLB	60,000	110,000	22,000	0,78	1	NTN
6212LLBNR	60,000	110,000	22,000	0,80	1-NR	NTN
6212LLU	60,000	110,000	22,000	0,78	1	NTN
6212LLUNR	60,000	110,000	22,000	0,79	1-NR	NTN
6212LU	60,000	110,000	22,000	0,76	1	NTN
6212N	60,000	110,000	22,000	0,78	1-NR	NTN-SNR
6212NR	60,000	110,000	22,000	0,78	1-NR	NTN-SNR
6212NRZ	60,000	110,000	22,000	0,79	1-NR	SNR
6212Z	60,000	110,000	22,000	0,75	1	NTN-SNR
6212ZNR	60,000	110,000	22,000	0,78	1-NR	NTN
6212ZZ	60,000	110,000	22,000	0,77	1	NTN-SNR
6212ZZNR	60,000	110,000	22,000	0,79	1-NR	NTN
6213	65,000	120,000	23,000	0,99	1	NTN-SNR
6213E	65,000	120,000	23,000	0,99	1	SNR



Reference	d	D	B	Kg		Brands
6213EE	65,000	120,000	23,000	1,02	1	SNR
6213F600	65,000	120,000	23,000	0,97	1	SNR
6213FT150	65,000	120,000	23,000	1,00	1	SNR
6213LB	65,000	120,000	23,000	0,99	1	NTN
6213LLB	65,000	120,000	23,000	0,98	1	NTN
6213LLBNR	65,000	120,000	23,000	0,98	1-NR	NTN
6213LLU	65,000	120,000	23,000	0,98	1	NTN
6213LLUNR	65,000	120,000	23,000	1,02	1-NR	NTN
6213LU	65,000	120,000	23,000	0,99	1	NTN
6213N	65,000	120,000	23,000	0,97	1-NR	NTN-SNR
6213NR	65,000	120,000	23,000	0,97	1-NR	NTN-SNR
6213Z	65,000	120,000	23,000	0,97	1	NTN-SNR
6213ZNR	65,000	120,000	23,000	1,01	1-NR	NTN
6213ZZ	65,000	120,000	23,000	0,98	1	NTN-SNR
6213ZZNR	65,000	120,000	23,000	1,02	1-NR	NTN
6214	70,000	125,000	24,000	1,05	1	NTN-SNR
6214E	70,000	125,000	24,000	1,08	1	SNR
6214EE	70,000	125,000	24,000	1,10	1	SNR
6214F600	70,000	125,000	24,000	1,08	1	SNR
6214LB	70,000	125,000	24,000	1,05	1	NTN
6214LLB	70,000	125,000	24,000	1,06	1	NTN
6214LLBNR	70,000	125,000	24,000	1,10	1-NR	NTN
6214LLU	70,000	125,000	24,000	1,06	1	NTN
6214LU	70,000	125,000	24,000	1,06	1	NTN
6214N	70,000	125,000	24,000	1,08	1-NR	SNR
6214NR	70,000	125,000	24,000	1,09	1-NR	NTN
6214Z	70,000	125,000	24,000	1,05	1	NTN-SNR
6214ZNR	70,000	125,000	24,000	1,08	1-NR	NTN
6214ZZ	70,000	125,000	24,000	1,06	1	NTN-SNR
6214ZZNR	70,000	125,000	24,000	1,10	1-NR	NTN
6215	75,000	130,000	25,000	1,18	1	NTN-SNR
6215/72	72,000	130,000	25,000	1,30	1	NTN
6215EE	75,000	130,000	25,000	1,19	1	SNR
6215LB	75,000	130,000	25,000	1,15	1	NTN
6215LLB	75,000	130,000	25,000	1,15	1	NTN
6215LLU	75,000	130,000	25,000	1,15	1	NTN
6215LLUNR	75,000	130,000	25,000	1,20	1-NR	NTN
6215LU	75,000	130,000	25,000	1,15	1	NTN
6215N	75,000	130,000	25,000	1,18	1-NR	NTN
6215NR	75,000	130,000	25,000	1,22	1-NR	NTN
6215Z	75,000	130,000	25,000	1,15	1	NTN
6215ZNR	75,000	130,000	25,000	1,19	1-NR	NTN
6215ZZ	75,000	130,000	25,000	1,12	1	NTN-SNR
6215ZZNR	75,000	130,000	25,000	1,20	1-NR	NTN
6216	80,000	140,000	26,000	1,39	1	NTN-SNR
6216E	80,000	140,000	26,000	1,41	1	SNR
6216EE	80,000	140,000	26,000	1,44	1	SNR
6216LB	80,000	140,000	26,000	1,38	1	NTN
6216LLB	80,000	140,000	26,000	1,39	1	NTN
6216LLU	80,000	140,000	26,000	1,39	1	NTN
6216LLUNR	80,000	140,000	26,000	1,35	1-NR	NTN
6216LU	80,000	140,000	26,000	1,38	1	NTN
6216NR	80,000	140,000	26,000	1,45	1-NR	NTN
6216Z	80,000	140,000	26,000	1,38	1	NTN
6216ZNR	80,000	140,000	26,000	1,42	1-NR	NTN
6216ZZ	80,000	140,000	26,000	1,39	1	NTN-SNR
6216ZZD2	80,000	140,000	52,000	2,78	1	NTN
6216ZZNR	80,000	140,000	26,000	1,44	1-NR	NTN

Reference	d	D	B	Kg		Brands
6217	85,000	150,000	28,000	1,79	1	NTN-SNR
6217EE	85,000	150,000	28,000	1,80	1	SNR
6217F600	85,000	150,000	28,000	1,79	1	SNR
6217LB	85,000	150,000	28,000	1,79	1	NTN
6217LLB	85,000	150,000	28,000	1,82	1	NTN
6217LLU	85,000	150,000	28,000	1,82	1	NTN
6217LU	85,000	150,000	28,000	1,80	1	NTN
6217N	85,000	150,000	28,000	1,78	1-NR	SNR
6217NR	85,000	150,000	28,000	1,84	1-NR	NTN
6217Z	85,000	150,000	28,000	1,80	1	NTN
6217ZNR	85,000	150,000	28,000	1,85	1-NR	NTN
6217ZZ	85,000	150,000	28,000	1,81	1	NTN-SNR
6217ZZNR	85,000	150,000	28,000	1,85	1-NR	NTN
6218	90,000	160,000	30,000	2,11	1	NTN-SNR
6218EE	90,000	160,000	30,000	2,23	1	SNR
6218LB	90,000	160,000	30,000	2,13	1	NTN
6218LLB	90,000	160,000	30,000	2,15	1	NTN
6218LLU	90,000	160,000	30,000	2,16	1	NTN
6218LLUD2	90,000	160,000	60,000	4,61	1	NTN
6218LU	90,000	160,000	30,000	2,13	1	NTN
6218NR	90,000	160,000	30,000	2,11	1-NR	NTN
6218Z	90,000	160,000	30,000	2,13	1	NTN
6218ZNR	90,000	160,000	30,000	2,19	1-NR	NTN
6218ZZ	90,000	160,000	30,000	2,11	1	NTN-SNR
6218ZZNR	90,000	160,000	30,000	2,21	1-NR	NTN
6219	95,000	170,000	32,000	2,62	1	NTN-SNR
6219EE	95,000	170,000	32,000	2,77	1	SNR
6219LLB	95,000	170,000	32,000	2,61	1	NTN
6219LLU	95,000	170,000	32,000	2,61	1	NTN
6219NR	95,000	170,000	32,000	2,70	1-NR	NTN
6219Z	95,000	170,000	32,000	2,57	1	NTN-SNR
6219ZZ	95,000	170,000	32,000	2,60	1	NTN-SNR
6219ZZNR	95,000	170,000	32,000	2,70	1-NR	NTN
6220	100,000	180,000	34,000	3,09	1	NTN-SNR
6220EE	10,000	30,000	14,000	0,05	1	SNR
6220ZZ	10,000	30,000	14,000	0,05	1	SNR
62201EE	12,000	32,000	14,000	0,05	1	SNR
62201LLU	12,000	32,000	14,000	0,05	1	NTN
62202EE	15,000	35,000	14,000	0,06	1	SNR
62203EE	17,000	40,000	16,000	0,09	1	SNR
62204EE	20,000	47,000	18,000	0,14	1	SNR
62205EE	25,000	52,000	18,000	0,16	1	SNR
62206EE	30,000	62,000	20,000	0,25	1	SNR
62207EE	35,000	72,000	23,000	0,40	1	SNR
62208EE	40,000	80,000	23,000	0,47	1	SNR
62209EE	45,000	85,000	23,000	0,49	1	SNR
6220D2	100,000	180,000	68,000	6,20	1	NTN
6220EE	100,000	180,000	34,000	3,22	1	SNR
6220LLB	100,000	180,000	34,000	3,13	1	NTN
6220LLU	100,000	180,000	34,000	1,32	1	NTN
6220LU	100,000	180,000	34,000	3,09	1	NTN
6220N	100,000	180,000	34,000	3,07	1-NR	NTN
6220NR	100,000	180,000	34,000	3,14	1-NR	NTN
6220Z	100,000	180,000	34,000	3,04	1	NTN
6220ZZ	100,000	180,000	34,000	3,01	1	NTN-SNR
6220ZZNR	100,000	180,000	34,000	3,23	1-NR	NTN
6221	105,000	190,000	36,000	3,70	1	NTN-SNR
62210EE	50,000	90,000	23,000	0,53	1	SNR

Reference	d	D	B	Kg		Brands
6221LLB	105,000	190,000	36,000	3,76	1	NTN
6221LLU	105,000	190,000	36,000	3,76	1	NTN
6221LLUNR	105,000	190,000	36,000	3,77	1-NR	NTN
6221NR	105,000	190,000	36,000	3,79	1-NR	NTN
6221Z	105,000	190,000	36,000	3,69	1	NTN
6221ZNR	105,000	190,000	36,000	3,78	1-NR	NTN
6221ZZ	105,000	190,000	36,000	3,74	1	NTN
6222	110,000	200,000	38,000	4,38	1	NTN-SNR
6222LLB	110,000	200,000	38,000	4,42	1	NTN
6222LLU	110,000	200,000	38,000	4,42	1	NTN
6222LLUNR	110,000	200,000	38,000	4,48	1-NR	NTN
6222LU	110,000	200,000	38,000	4,35	1	NTN
6222NR	110,000	200,000	38,000	4,46	1-NR	NTN
6222Z	110,000	200,000	38,000	4,37	1	NTN
6222ZZ	110,000	200,000	38,000	4,42	1	NTN
6224	120,000	215,000	40,000	5,15	1	NTN-SNR
6224LLB	120,000	215,000	40,000	5,32	1	NTN
6224LLU	120,000	215,000	40,000	5,32	1	NTN
6224Z	120,000	215,000	40,000	5,27	1	NTN
6224ZZ	120,000	215,000	40,000	5,35	1	NTN
6226	130,000	230,000	40,000	5,91	1	NTN-SNR
6226LLU	130,000	230,000	40,000	5,98	1	NTN
6226Z	130,000	230,000	40,000	5,90	1	NTN
6226ZZ	130,000	230,000	40,000	5,97	1	NTN
6228	140,000	250,000	42,000	7,57	1	NTN-SNR
6228LLU	140,000	250,000	42,000	6,20	1	NTN
6228Z	140,000	250,000	42,000	7,54	1	NTN
6228ZZ	140,000	250,000	42,000	7,62	1	NTN
623	3,000	10,000	4,000	0,002	1	NTN-SNR
623/22LLU/222	22,200	56,000	21,000	0,23	1	NTN
6230	150,000	270,000	45,000	9,41	1	NTN-SNR
62300EE	10,000	35,000	17,000	0,08	1	SNR
62301EE	12,000	37,000	17,000	0,07	1	SNR
62302EE	15,000	42,000	17,000	0,11	1	SNR
62303EE	17,000	47,000	19,000	0,15	1	SNR
62304EE	20,000	52,000	21,000	0,20	1	SNR
62304LLUA/17	17,000	52,000	21,000	0,22	1	NTN
62305EE	25,000	62,000	24,000	0,33	1	SNR
62306EE	30,000	72,000	27,000	0,49	1	SNR
62307EE	35,000	80,000	31,000	0,66	1	SNR
62308EE	40,000	90,000	33,000	0,90	1	SNR
6230LLU	150,000	270,000	45,000	10,06	1	NTN
6230Z	150,000	270,000	45,000	9,94	1	NTN
6230ZZ	150,000	270,000	45,000	10,04	1	NTN
6232	160,000	290,000	48,000	11,70	1	NTN
6232M	160,000	290,000	48,000	14,45	1	SNR
6232Z	160,000	290,000	48,000	12,74	1	NTN
6232ZZ	160,000	290,000	48,000	12,70	1	NTN
6234	170,000	310,000	52,000	15,90	1	NTN
6234M	170,000	310,000	52,000	17,70	1	SNR
6234Z	170,000	310,000	52,000	15,80	1	NTN
6234ZZ	170,000	310,000	52,000	14,50	1	NTN
6236	180,000	320,000	52,000	15,10	1	NTN
6236K	180,000	320,000	52,000	16,00	1	NTN

Reference	d	D	B	Kg		Brands
6236M	180,000	320,000	52,000	18,30	1	SNR
6236Z	180,000	320,000	52,000	15,80	1	NTN
6236ZZ	180,000	320,000	52,000	15,90	1	NTN
6238	190,000	340,000	55,000	19,20	1	NTN
6238M	190,000	340,000	55,000	22,20	1	SNR
6238Z	190,000	340,000	55,000	19,14	1	NTN
6238ZZ	190,000	340,000	55,000	19,17	1	NTN
623EE	3,000	10,000	4,000	0,002	1	SNR
623Z	3,000	10,000	4,000	0,002	1	SNR
623ZZ	3,000	10,000	4,000	0,002	1	NTN-SNR
624	4,000	13,000	5,000	0,003	1	NTN-SNR
6240	200,000	360,000	58,000	21,60	1	NTN
6240M	200,000	360,000	58,000	26,50	1	SNR
6240Z	200,000	360,000	58,000	23,40	1	NTN
6240ZZ	200,000	360,000	58,000	23,50	1	NTN
6244	220,000	400,000	65,000	33,00	1	NTN
6248	240,000	440,000	72,000	51,70	1	NTN
624EE	4,000	13,000	5,000	0,01	1	SNR
624ZZ	4,000	13,000	5,000	0,003	1	NTN-SNR
625	5,000	16,000	5,000	0,004	1	NTN-SNR
6252	260,000	480,000	80,000	65,70	1	NTN
6256	280,000	500,000	80,000	70,90	1	NTN
625EE	5,000	16,000	5,000	0,01	1	SNR
625LLB	5,000	16,000	5,000	0,005	1	NTN
625LLU	5,000	16,000	5,000	0,005	1	NTN
625Z	5,000	16,000	5,000	0,005	1	NTN-SNR
625ZZ	5,000	16,000	5,000	0,005	1	NTN-SNR
626	6,000	19,000	6,000	0,01	1	NTN-SNR
6260	300,000	540,000	85,000	88,90	1	NTN
6264	320,000	580,000	92,000	110,00	1	NTN
6268	340,000	620,000	92,000	129,00	1	NTN
626EE	6,000	19,000	6,000	0,01	1	SNR
626LLB	6,000	19,000	6,000	0,01	1	NTN
626LLU	6,000	19,000	6,000	0,01	1	NTN
626Z	6,000	19,000	6,000	0,01	1	NTN-SNR
626ZZ	6,000	19,000	6,000	0,01	1	NTN-SNR
627	7,000	22,000	7,000	0,01	1	NTN-SNR
6272	360,000	650,000	95,000	145,00	1	NTN
627EE	7,000	22,000	7,000	0,02	1	SNR
627LLB	7,000	22,000	7,000	0,01	1	NTN
627LLU	7,000	22,000	7,000	0,01	1	NTN
627Z	7,000	22,000	7,000	0,01	1	NTN-SNR
627ZZ	7,000	22,000	7,000	0,01	1	NTN-SNR
628LLB	8,000	24,000	8,000	0,02	1	NTN
628LLH	8,000	24,000	8,000	0,02	1	NTN
628LU	8,000	24,000	8,000	0,02	1	NTN
628Z	8,000	24,000	8,000	0,02	1	NTN
628ZZ	8,000	24,000	8,000	0,02	1	NTN
629	9,000	26,000	8,000	0,02	1	SNR
629EE	9,000	26,000	8,000	0,02	1	SNR
629X50	9,000	26,000	8,000	20,00	1	NTN
629X50LLB	9,000	26,000	8,000	0,02	1	NTN
629X50LLU	9,000	26,000	8,000	0,02	1	NTN
629X50Z	9,000	26,000	8,000	0,02	1	NTN



Reference	d	D	B	Kg		Brands
629X50ZZ	9,000	26,000	8,000	0,02	1	NTN
629ZZ	9,000	26,000	8,000	0,02	1	SNR
63/22	22,000	56,000	16,000	0,18	1	NTN
63/22C/20	20,000	56,000	16,000	0,18	1	NTN
63/22LLU	22,000	56,000	16,000	0,14	1	NTN
63/22LU	22,000	56,000	16,000	0,17	1	NTN
63/22N	22,000	56,000	16,000	0,18	1-NR	NTN
63/22NR	22,000	56,000	16,000	0,18	1-NR	NTN
63/22X	22,000	56,000	16,000	0,18	1	NTN
63/22Z	22,000	56,000	16,000	0,14	1	NTN
63/22ZZ	22,000	56,000	16,000	0,14	1	NTN
63/22ZZNR	22,000	56,000	16,000	0,14	1-NR	NTN
63/28	28,000	68,000	18,000	0,28	1	NTN
63/28LLB	28,000	68,000	18,000	0,29	1	NTN
63/28LLHN	28,000	68,000	18,000	0,28	1-NR	NTN
63/28LLU	28,000	68,000	18,000	0,29	1	NTN
63/28LLUNR	28,000	68,000	18,000	0,28	1-NR	NTN
63/28NR	28,000	68,000	18,000	0,26	1-NR	NTN
63/28Z	28,000	68,000	18,000	0,28	1	NTN
63/28ZZ	28,000	68,000	18,000	0,29	1	NTN
63/32	32,000	75,000	20,000	0,39	1	NTN
63/32LLU	32,000	75,000	20,000	0,39	1	NTN
63/32LLUNR	32,000	75,000	20,000	0,40	1-NR	NTN
63/32N	32,000	75,000	20,000	0,39	1-NR	NTN
63/32NR	32,000	75,000	20,000	0,40	1-NR	NTN
63/32Z	32,000	75,000	20,000	0,38	1	NTN
63/32ZNR	32,000	75,000	20,000	0,39	1-NR	NTN
63/32ZZ	20,000	42,000	16,000	0,09	1	NTN
6300	10,000	35,000	11,000	0,05	1	NTN-SNR
6300EE	10,000	26,000	12,000	0,03	1	SNR
63001EE	12,000	28,000	12,000	0,03	1	SNR
63002EE	15,000	32,000	13,000	0,05	1	SNR
63003EE	17,000	35,000	14,000	0,06	1	SNR
63004EE	20,000	42,000	16,000	0,09	1	SNR
63005EE	25,000	47,000	16,000	0,11	1	SNR
63006EE	30,000	55,000	19,000	0,17	1	SNR
63007EE	35,000	62,000	20,000	0,22	1	SNR
63008EE	40,000	68,000	21,000	0,26	1	SNR
6300EE	10,000	35,000	11,000	0,06	1	SNR
6300FT150ZZ	10,000	35,000	11,000	0,05	1	SNR
6300LLB	10,000	35,000	11,000	0,05	1	NTN
6300LLU	10,000	35,000	11,000	0,05	1	NTN
6300LU	10,000	35,000	11,000	0,05	1	NTN
6300Z	10,000	35,000	11,000	0,05	1	NTN
6300ZZ	10,000	35,000	11,000	0,05	1	NTN-SNR
6300ZZNR	10,000	35,000	11,000	0,05	1-NR	NTN
6301	12,000	37,000	12,000	0,06	1	NTN-SNR
6301EE	12,000	37,000	12,000	0,07	1	SNR
6301FT150ZZ	12,000	37,000	12,000	0,06	1	SNR
6301LLB	12,000	37,000	12,000	0,06	1	NTN
6301LLH	12,000	37,000	12,000	0,06	1	NTN
6301LLU	12,000	37,000	12,000	0,06	1	NTN
6301LLUNR	12,000	37,000	12,000	0,06	1-NR	NTN
6301LU	12,000	37,000	12,000	0,06	1	NTN
6301Z	12,000	37,000	12,000	0,06	1	NTN-SNR
6301ZZ	12,000	37,000	12,000	0,06	1	NTN-SNR

Reference	d	D	B	Kg		Brands
6301ZZNR	12,000	37,000	12,000	0,06	1-NR	NTN
6302	15,000	42,000	13,000	0,08	1	NTN-SNR
6302E	15,000	42,000	13,000	0,09	1	SNR
6302EE	15,000	42,000	13,000	0,09	1	SNR
6302FT150ZZ	15,000	42,000	13,000	0,09	1	SNR
6302LB	15,000	42,000	13,000	0,08	1	NTN
6302LLB	15,000	42,000	13,000	0,08	1	NTN
6302LLBNR	15,000	42,000	13,000	0,08	1-NR	NTN
6302LLH	15,000	42,000	13,000	0,08	1	NTN
6302LLU	15,000	42,000	13,000	0,08	1	NTN
6302LLUNR	15,000	42,000	13,000	0,08	1-NR	NTN
6302LU	15,000	42,000	13,000	0,08	1	NTN
6302NR	15,000	42,000	13,000	0,08	1-NR	NTN
6302Z	15,000	42,000	13,000	0,08	1	NTN-SNR
6302ZNR	15,000	42,000	13,000	0,08	1-NR	NTN
6302ZZ	15,000	42,000	13,000	0,08	1	NTN-SNR
6302ZZN	15,000	42,000	13,000	0,08	1-NR	NTN
6302ZZNR	15,000	42,000	13,000	0,08	1-NR	NTN
6303	17,000	47,000	14,000	0,12	1	NTN-SNR
6303E	17,000	47,000	14,000	0,12	1	SNR
6303EE	17,000	47,000	14,000	0,11	1	SNR
6303FT150	17,000	47,000	14,000	0,12	1	SNR
6303FT150ZZ	17,000	47,000	14,000	0,12	1	SNR
6303G15	17,000	47,000	14,000	0,11	1	SNR
6303LB	17,000	47,000	14,000	0,11	1	NTN
6303LLB	17,000	47,000	14,000	0,12	1	NTN
6303LLBNR	17,000	47,000	14,000	0,12	1-NR	NTN
6303LLH	17,000	47,000	14,000	0,11	1	NTN
6303LLU	17,000	47,000	14,000	0,11	1	NTN
6303LLUNR	17,000	47,000	14,000	0,12	1-NR	NTN
6303LU	17,000	47,000	14,000	0,11	1	NTN
6303LUZ	17,000	47,000	14,000	0,12	1	NTN
6303NR	17,000	47,000	14,000	0,12	1-NR	NTN
6303Z	17,000	47,000	14,000	0,11	1	NTN-SNR
6303ZNR	17,000	47,000	14,000	0,11	1-NR	NTN
6303ZZ	17,000	47,000	14,000	0,11	1	NTN-SNR
6303ZZNR	17,000	47,000	14,000	0,12	1-NR	NTN
6304	20,000	52,000	15,000	0,14	1	NTN-SNR
6304/22	22,000	52,000	15,000	0,13	1	NTN
6304E	20,000	52,000	15,000	0,14	1	SNR
6304EE	20,000	52,000	15,000	0,15	1	SNR
6304FT150	20,000	52,000	15,000	0,15	1	SNR
6304FT150ZZ	20,000	52,000	15,000	0,15	1	SNR
6304G15	20,000	52,000	15,000	0,14	1	SNR
6304HT200	20,000	52,000	15,000	0,15	1	SNR
6304HT200ZZ	20,000	52,000	15,000	0,15	1	SNR
6304LB	20,000	52,000	15,000	0,14	1	NTN
6304LLB	20,000	52,000	15,000	0,15	1	NTN
6304LLBNR	20,000	52,000	15,000	0,15	1-NR	NTN
6304LLH	20,000	52,000	15,000	0,14	1	NTN
6304LLU	20,000	52,000	15,000	0,14	1	NTN
6304LLUNR	20,000	52,000	15,000	0,15	1-NR	NTN
6304LTZZ	20,000	52,000	15,000	0,14	1	SNR
6304LU	20,000	52,000	15,000	0,14	1	NTN
6304NEE	20,000	52,000	15,000	0,15	1-NR	SNR
6304NR	20,000	52,000	15,000	0,15	1-NR	NTN-SNR
6304NREE	20,000	52,000	15,000	0,15	1-NR	SNR
6304NRZ	20,000	52,000	15,000	0,14	1-NR	SNR
6304Z	20,000	52,000	15,000	0,14	1	NTN-SNR

Reference	d	D	B	Kg		Brands
6304ZNR	20,000	52,000	15,000	0,14	1-NR	NTN
6304ZZ	20,000	52,000	15,000	0,14	1	NTN-SNR
6304ZZN	20,000	52,000	15,000	0,14	1-NR	NTN
6304ZZNR	20,000	52,000	15,000	0,14	1-NR	NTN
6305	25,000	62,000	17,000	0,23	1	NTN-SNR
6305/65	25,000	65,000	17,000	0,27	1	NTN
6305C	25,000	62,000	17,000	0,22	1	NTN
6305E	25,000	62,000	17,000	0,23	1	SNR
6305EE	25,000	62,000	17,000	0,23	1	SNR
6305F600	25,000	62,000	17,000	0,24	1	SNR
6305FT150	25,000	62,000	17,000	0,24	1	SNR
6305FT150ZZ	25,000	62,000	17,000	0,23	1	SNR
6305HT200	25,000	62,000	17,000	0,23	1	SNR
6305HT200ZZ	25,000	62,000	17,000	0,23	1	SNR
6305LB	25,000	62,000	17,000	0,23	1	NTN
6305LLB	25,000	62,000	17,000	0,22	1	NTN
6305LLBNR	25,000	62,000	17,000	0,24	1-NR	NTN
6305LLH	25,000	62,000	17,000	0,22	1	NTN
6305LLU	25,000	62,000	17,000	0,22	1	NTN
6305LLUNR	25,000	62,000	17,000	0,24	1-NR	NTN
6305LU	25,000	62,000	17,000	0,22	1	NTN
6305N	25,000	62,000	17,000	0,23	1-NR	NTN-SNR
6305NR	25,000	62,000	17,000	0,23	1-NR	NTN-SNR
6305NREE	25,000	62,000	17,000	0,23	1-NR	SNR
6305NRZ	25,000	62,000	17,000	0,24	1-NR	SNR
6305NRZZ	25,000	62,000	17,000	0,24	1-NR	SNR
6305Z	25,000	62,000	17,000	0,22	1	NTN-SNR
6305Z/22	22,000	62,000	17,000	0,24	1	NTN
6305ZNR	25,000	62,000	17,000	0,24	1-NR	NTN
6305ZZ	25,000	62,000	17,000	0,22	1	NTN-SNR
6305ZZD2	25,000	62,000	34,000	0,46	1	NTN
6305ZZNR	25,000	62,000	17,000	0,22	1-NR	NTN
6306	30,000	72,000	19,000	0,34	1	NTN-SNR
6306C	30,000	72,000	19,000	0,34	1	NTN
6306D2	30,000	72,000	38,000	0,68	1	NTN
6306E	30,000	72,000	19,000	0,35	1	SNR
6306EE	30,000	72,000	19,000	0,36	1	SNR
6306EG15	30,000	72,000	19,000	0,34	1	SNR
6306F600	30,000	72,000	19,000	0,35	1	SNR
6306FT150	30,000	72,000	19,000	0,36	1	SNR
6306FT150ZZ	30,000	72,000	19,000	0,36	1	SNR
6306HT200	30,000	72,000	19,000	0,37	1	SNR
6306HT200ZZ	30,000	72,000	19,000	0,35	1	SNR
6306LB	30,000	72,000	19,000	0,36	1	NTN
6306LLB	30,000	72,000	19,000	0,33	1	NTN
6306LLBNR	30,000	72,000	19,000	0,37	1-NR	NTN
6306LLH	30,000	72,000	19,000	0,35	1	NTN
6306LLU	30,000	72,000	19,000	0,33	1	NTN
6306LLUNR	30,000	72,000	19,000	0,36	1-NR	NTN
6306LU	30,000	72,000	19,000	0,34	1	NTN
6306N	30,000	72,000	19,000	0,34	1-NR	NTN-SNR
6306NR	30,000	72,000	19,000	0,35	1-NR	NTN-SNR
6306NREE	30,000	72,000	19,000	0,36	1-NR	SNR
6306NRZ	30,000	72,000	19,000	0,36	1-NR	SNR
6306NRZZ	30,000	72,000	19,000	0,37	1-NR	SNR
6306Z	30,000	72,000	19,000	0,34	1	NTN-SNR
6306ZNR	30,000	72,000	19,000	0,33	1-NR	NTN
6306ZZ	30,000	72,000	19,000	0,33	1	NTN-SNR
6306ZZD2	30,000	72,000	38,000	0,71	1	NTN
6306ZZNR	30,000	72,000	19,000	0,36	1-NR	NTN

Reference	d	D	B	Kg		Brands
6307	35,000	80,000	21,000	0,46	1	NTN-SNR
6307E	35,000	80,000	21,000	0,46	1	SNR
6307EE	35,000	80,000	21,000	0,46	1	SNR
6307FT150	35,000	80,000	21,000	0,46	1	SNR
6307FT150ZZ	35,000	80,000	21,000	0,45	1	SNR
6307HT200	35,000	80,000	21,000	0,48	1	SNR
6307HT200ZZ	35,000	80,000	21,000	0,47	1	SNR
6307LB	35,000	80,000	21,000	0,45	1	NTN
6307LLB	35,000	80,000	21,000	0,45	1	NTN
6307LLBNR	35,000	80,000	21,000	0,47	1-NR	NTN
6307LLH	35,000	80,000	21,000	0,46	1	NTN
6307LLU	35,000	80,000	21,000	0,46	1	NTN
6307LLUN	35,000	80,000	21,000	0,46	1-NR	NTN
6307LLUNR	35,000	80,000	21,000	0,47	1-NR	NTN
6307LU	35,000	80,000	21,000	0,45	1	NTN
6307N	35,000	80,000	21,000	0,45	1-NR	NTN-SNR
6307NR	35,000	80,000	21,000	0,46	1-NR	NTN-SNR
6307NREE	35,000	80,000	21,000	0,48	1-NR	SNR
6307NRZ	35,000	80,000	21,000	0,45	1-NR	SNR
6307NRZZ	35,000	80,000	21,000	0,45	1-NR	SNR
6307Z	35,000	80,000	21,000	0,45	1	NTN-SNR
6307ZNR	35,000	80,000	21,000	0,46	1-NR	NTN
6307ZZ	35,000	80,000	21,000	0,46	1	NTN-SNR
6307ZZD2	35,000	80,000	42,000	0,92	1	NTN
6307ZZK+H307X	35,000	80,000	35,000	0,60	1	NTN
6307ZZNR	35,000	80,000	21,000	0,47	1-NR	NTN
6308	40,000	90,000	23,000	0,63	1	NTN-SNR
6308E	40,000	90,000	23,000	0,64	1	SNR
6308EE	40,000	90,000	23,000	0,64	1	SNR
6308FT150	40,000	90,000	23,000	0,63	1	SNR
6308FT150ZZ	40,000	90,000	23,000	0,61	1	SNR
6308HT200	40,000	90,000	23,000	0,65	1	SNR
6308HT200ZZ	40,000	90,000	23,000	0,65	1	SNR
6308HVZZ	40,000	90,000	23,000	0,63	1	SNR
6308LB	40,000	90,000	23,000	0,62	1	NTN
6308LH	40,000	90,000	23,000	0,60	1	NTN
6308LLB	40,000	90,000	23,000	0,61	1	NTN
6308LLBNR	40,000	90,000	23,000	0,65	1-NR	NTN
6308LLH	40,000	90,000	23,000	0,64	1	NTN
6308LLU	40,000	90,000	23,000	0,64	1	NTN
6308LLUNR	40,000	90,000	23,000	0,60	1-NR	NTN
6308LU	40,000	90,000	23,000	0,63	1	NTN
6308LUNR	40,000	90,000	23,000	0,75	1-NR	NTN
6308N	40,000	90,000	23,000	0,62	1-NR	NTN-SNR
6308NR	40,000	90,000	23,000	0,65	1-NR	NTN-SNR
6308NREE	40,000	90,000	23,000	0,61	1-NR	SNR
6308NRZ	40,000	90,000	23,000	0,61	1-NR	SNR
6308NRZZ	40,000	90,000	23,000	0,67	1-NR	SNR
6308Z	40,000	90,000	23,000	0,62	1	NTN-SNR
6308ZNR	40,000	90,000	23,000	0,64	1-NR	NTN
6308ZZ	40,000	90,000	23,000	0,61	1	NTN-SNR
6308ZZD2	40,000	90,000	46,000	1,27	1	NTN
6308ZZNR	40,000	90,000	23,000	0,65	1-NR	NTN
6309	45,000	100,000	25,000	0,81	1	NTN-SNR
6309/40	40,000	100,000	25,000	0,88	1	NTN
6309D2	45,000	100,000	50,000	1,63	1	NTN
6309E	45,000	100,000	25,000	0,86	1	SNR
6309EE	45,000	100,000	25,000	0,87	1	SNR
6309F600	45,000	100,000	25,000	0,83	1	SNR
6309F603	45,000	100,000	25,000	0,83	1	SNR



Reference	d	D	B	Kg		Brands
6309FT150	45,000	100,000	25,000	0,86	1	SNR
6309FT150ZZ	45,000	100,000	25,000	0,85	1	SNR
6309HT200	45,000	100,000	25,000	0,86	1	SNR
6309HT200ZZ	45,000	100,000	25,000	0,86	1	SNR
6309KEE	45,000	100,000	25,000	0,86	1	SNR
6309LB	45,000	100,000	25,000	0,81	1	NTN
6309LLB	45,000	100,000	25,000	0,80	1	NTN
6309LLBNR	45,000	100,000	25,000	0,85	1-NR	NTN
6309LLH	45,000	100,000	25,000	0,83	1	NTN
6309LLU	45,000	100,000	25,000	0,83	1	NTN
6309LLUNR	45,000	100,000	25,000	0,82	1-NR	NTN
6309LU	45,000	100,000	25,000	0,80	1	NTN
6309N	45,000	100,000	25,000	0,84	1-NR	SNR
6309NR	45,000	100,000	25,000	0,83	1-NR	NTN-SNR
6309NREE	45,000	100,000	25,000	0,88	1-NR	SNR
6309NRZ	45,000	100,000	25,000	0,83	1-NR	SNR
6309NRZZ	45,000	100,000	25,000	0,83	1-NR	SNR
6309SEE	45,000	100,000	25,000	0,83	1	SNR
6309Z	45,000	100,000	25,000	0,80	1	NTN-SNR
6309ZNR	45,000	100,000	25,000	0,82	1-NR	NTN
6309ZZ	45,000	100,000	25,000	0,79	1	NTN-SNR
6309ZZD2	45,000	100,000	50,000	1,65	1	NTN
6309ZZNR	45,000	100,000	25,000	0,84	1-NR	NTN
6310	50,000	110,000	27,000	1,05	1	NTN-SNR
6310C	50,000	110,000	27,000	1,07	1	NTN
6310D2	50,000	110,000	54,000	2,10	1	NTN
6310E	50,000	110,000	27,000	1,10	1	SNR
6310EE	50,000	110,000	27,000	1,12	1	SNR
6310FT150	50,000	110,000	27,000	1,11	1	SNR
6310FT150ZZ	50,000	110,000	27,000	1,11	1	SNR
6310HT200	50,000	110,000	27,000	1,12	1	SNR
6310HT200ZZ	50,000	110,000	27,000	1,11	1	SNR
6310LB	50,000	110,000	27,000	1,05	1	NTN
6310LH	50,000	110,000	27,000	1,08	1	NTN
6310LLB	50,000	110,000	27,000	1,08	1	NTN
6310LLBNR	50,000	110,000	27,000	1,12	1-NR	NTN
6310LLU	50,000	110,000	27,000	1,08	1	NTN
6310LLUNR	50,000	110,000	27,000	1,08	1-NR	NTN
6310LU	50,000	110,000	27,000	1,05	1	NTN
6310N	50,000	110,000	27,000	1,04	1-NR	NTN-SNR
6310NEE	50,000	110,000	27,000	1,08	1-NR	SNR
6310NR	50,000	110,000	27,000	1,08	1-NR	NTN-SNR
6310NREE	50,000	110,000	27,000	1,07	1-NR	SNR
6310NRZ	50,000	110,000	27,000	1,14	1-NR	SNR
6310NRZZ	50,000	110,000	27,000	1,07	1-NR	SNR
6310Z	50,000	110,000	27,000	1,05	1	NTN-SNR
6310ZNR	50,000	110,000	27,000	1,07	1-NR	NTN
6310ZZ	50,000	110,000	27,000	1,08	1	NTN-SNR
6310ZZD2	50,000	110,000	54,000	2,16	1	NTN
6310ZZNR	50,000	110,000	27,000	1,12	1-NR	NTN
6311	55,000	120,000	29,000	1,37	1	NTN-SNR
6311E	55,000	120,000	29,000	1,40	1	SNR
6311EE	55,000	120,000	29,000	1,40	1	SNR
6311F600	55,000	120,000	29,000	1,37	1	SNR
6311LB	55,000	120,000	29,000	1,30	1	NTN
6311LLB	55,000	120,000	29,000	1,31	1	NTN
6311LLBNR	55,000	120,000	29,000	1,40	1-NR	NTN
6311LLU	55,000	120,000	29,000	1,19	1	NTN
6311LLUNR	55,000	120,000	29,000	1,44	1-NR	NTN
6311LU	55,000	120,000	29,000	1,30	1	NTN

Reference	d	D	B	Kg		Brands
6311LUNR	55,000	120,000	29,000	3,92	1-NR	NTN
6311N	55,000	120,000	29,000	1,31	1-NR	NTN-SNR
6311NR	55,000	120,000	29,000	1,37	1-NR	NTN-SNR
6311Z	55,000	120,000	29,000	1,34	1	NTN
6311ZNR	55,000	120,000	29,000	1,38	1-NR	NTN
6311ZZ	55,000	120,000	29,000	1,34	1	NTN-SNR
6311ZZD2	55,000	120,000	58,000	2,69	1	NTN
6311ZZNR	55,000	120,000	29,000	1,40	1-NR	NTN
6312	60,000	130,000	31,000	1,67	1	NTN-SNR
6312D2	60,000	130,000	62,000	3,34	1	NTN
6312EE	60,000	130,000	31,000	1,74	1	SNR
6312LB	60,000	130,000	31,000	1,68	1	NTN
6312BLU	60,000	130,000	31,000	1,72	1	NTN
6312LLB	60,000	130,000	31,000	1,65	1	NTN
6312LLBNR	60,000	130,000	31,000	1,75	1-NR	NTN
6312LLU	60,000	130,000	31,000	1,71	1	NTN
6312LLUNR	60,000	130,000	31,000	1,77	1-NR	NTN
6312LU	60,000	130,000	31,000	1,68	1	NTN
6312LUNR	60,000	130,000	31,000	1,73	1-NR	NTN
6312N	60,000	130,000	31,000	1,63	1-NR	SNR
6312NR	60,000	130,000	31,000	1,72	1-NR	NTN
6312Z	60,000	130,000	31,000	1,68	1	NTN-SNR
6312ZNR	60,000	130,000	31,000	1,72	1-NR	NTN
6312ZZ	60,000	130,000	31,000	1,60	1	NTN-SNR
6312ZZD2	60,000	130,000	62,000	3,42	1	NTN
6312ZZNR	60,000	130,000	31,000	2,14	1-NR	NTN
6313	65,000	140,000	33,000	2,08	1	NTN-SNR
6313/60	60,000	140,000	33,000	2,22	1	NTN
6313D2	65,000	140,000	66,000	4,09	1	NTN
6313EE	65,000	140,000	33,000	2,16	1	SNR
6313BLU	65,000	140,000	33,000	2,09	1	NTN
6313LLB	65,000	140,000	33,000	2,03	1	NTN
6313LLBNR	65,000	140,000	33,000	2,13	1-NR	NTN
6313LLU	65,000	140,000	33,000	2,09	1	NTN
6313LLUNR	65,000	140,000	33,000	2,15	1-NR	NTN
6313LU	65,000	140,000	33,000	2,06	1	NTN
6313LUNR	65,000	140,000	33,000	2,12	1-NR	NTN
6313N	65,000	140,000	33,000	2,09	1-NR	SNR
6313NR	65,000	140,000	33,000	2,13	1-NR	NTN-SNR
6313Z	65,000	140,000	33,000	2,07	1	NTN-SNR
6313ZNR	65,000	140,000	33,000	2,12	1-NR	NTN
6313ZZ	65,000	140,000	33,000	2,02	1	NTN-SNR
6313ZZD2	65,000	140,000	66,000	4,04	1	NTN
6313ZZNR	65,000	140,000	33,000	2,14	1-NR	NTN
6314	70,000	150,000	35,000	2,55	1	NTN-SNR
6314D2	70,000	150,000	70,000	4,37	1	NTN
6314EE	70,000	150,000	35,000	2,60	1	SNR
6314LB	70,000	150,000	35,000	2,54	1	NTN
6314BLU	70,000	150,000	35,000	2,46	1	NTN
6314LLB	70,000	150,000	35,000	2,48	1	NTN
6314LLU	70,000	150,000	35,000	2,49	1	NTN
6314LU	70,000	150,000	35,000	2,54	1	NTN
6314NR	70,000	150,000	35,000	2,57	1-NR	NTN
6314Z	70,000	150,000	35,000	2,54	1	NTN-SNR
6314ZNR	70,000	150,000	35,000	2,59	1-NR	NTN
6314ZZ	70,000	150,000	35,000	2,48	1	NTN-SNR
6314ZZD2	70,000	150,000	70,000	5,01	1	NTN
6314ZZNR	70,000	150,000	35,000	2,62	1-NR	NTN

Reference	d	D	B	Kg		Brands
6315	75,000	160,000	37,000	3,02	1	NTN-SNR
6315EE	75,000	160,000	37,000	3,10	1	SNR
6315LB	75,000	160,000	37,000	3,01	1	NTN
6315LLB	75,000	160,000	37,000	3,05	1	NTN
6315LLU	75,000	160,000	37,000	3,05	1	NTN
6315LLUNR	75,000	160,000	37,000	3,12	1-NR	NTN
6315LU	75,000	160,000	37,000	3,01	1	NTN
6315NR	75,000	160,000	37,000	3,07	1-NR	NTN
6315Z	75,000	160,000	37,000	3,00	1	NTN
6315ZNR	75,000	160,000	37,000	3,06	1-NR	NTN
6315ZZ	75,000	160,000	37,000	3,04	1	NTN-SNR
6315ZZNR	75,000	160,000	37,000	3,10	1-NR	NTN
6316	80,000	170,000	39,000	3,61	1	NTN-SNR
6316D2	80,000	170,000	78,000	7,20	1	NTN
6316EE	80,000	170,000	39,000	3,65	1	SNR
6316LB	80,000	170,000	39,000	3,59	1	NTN
6316LBU	80,000	170,000	39,000	3,66	1	NTN
6316LLB	80,000	170,000	39,000	3,67	1	NTN
6316LLU	80,000	170,000	39,000	3,66	1	NTN
6316LU	80,000	170,000	39,000	3,61	1	NTN
6316NR	80,000	170,000	39,000	3,67	1-NR	NTN
6316Z	80,000	170,000	39,000	3,59	1	NTN
6316ZNR	80,000	170,000	39,000	3,67	1-NR	NTN
6316ZZ	80,000	170,000	39,000	3,53	1	NTN-SNR
6316ZZNR	80,000	170,000	39,000	3,74	1-NR	NTN
6317	85,000	180,000	41,000	4,23	1	NTN-SNR
6317EE	85,000	180,000	41,000	4,32	1	SNR
6317LLB	85,000	180,000	41,000	4,25	1	NTN
6317LLU	85,000	180,000	41,000	4,25	1	NTN
6317LU	85,000	180,000	41,000	4,20	1	NTN
6317NR	85,000	180,000	41,000	4,31	1-NR	NTN
6317Z	85,000	180,000	41,000	4,21	1	NTN
6317ZNR	85,000	180,000	41,000	4,30	1-NR	NTN
6317ZZ	85,000	180,000	41,000	4,26	1	NTN-SNR
6318	90,000	190,000	43,000	4,90	1	NTN-SNR
6318EE	90,000	190,000	43,000	5,02	1	SNR
6318LLB	90,000	190,000	43,000	4,96	1	NTN
6318LLU	90,000	190,000	43,000	4,96	1	NTN
6318LU	90,000	190,000	43,000	4,90	1	NTN
6318NR	90,000	190,000	43,000	5,00	1-NR	NTN
6318Z	90,000	190,000	43,000	4,91	1	NTN
6318ZNR	90,000	190,000	43,000	5,01	1-NR	NTN
6318ZZ	90,000	190,000	43,000	4,95	1	NTN-SNR
6318ZZNR	90,000	190,000	43,000	5,06	1-NR	NTN
6319	95,000	200,000	45,000	5,67	1	NTN-SNR
6319D2	95,000	200,000	90,000	11,84	1	NTN
6319LLB	95,000	200,000	45,000	5,85	1	NTN
6319LLU	95,000	200,000	45,000	5,83	1	NTN
6319NR	95,000	200,000	45,000	5,77	1-NR	NTN
6319Z	95,000	200,000	45,000	5,74	1	NTN
6319ZZ	95,000	200,000	45,000	5,82	1	NTN-SNR
6320	100,000	215,000	47,000	7,08	1	NTN-SNR
63202LLB	15,000	35,000	15,875	0,06	1	NTN
63202LLU	15,000	35,000	15,870	0,06	1	NTN
63202ZZ	15,000	35,000	15,875	0,06	1	NTN
63203LLB	17,000	40,000	17,462	0,09	1	NTN
63203LLU	17,000	40,000	17,462	0,09	1	NTN

Reference	d	D	B	Kg		Brands
63203ZZ	17,000	40,000	17,462	0,09	1	NTN
63204LLB	20,000	47,000	20,600	0,15	1	NTN
63204LLU	20,000	47,000	20,600	0,15	1	NTN
63204ZZ	20,000	47,000	20,600	0,15	1	NTN
63205LLB	25,000	52,000	20,600	0,17	1	NTN
63205LLU	25,000	52,000	20,600	0,17	1	NTN
63205ZZ	25,000	52,000	20,600	0,17	1	NTN
63206LLB	30,000	62,000	23,800	0,29	1	NTN
63206LLU	30,000	62,000	23,800	0,29	1	NTN
63206ZZ	30,000	62,000	23,800	0,29	1	NTN
63207LLB	35,000	72,000	26,987	0,44	1	NTN
63207LLU	35,000	72,000	26,987	0,44	1	NTN
63207ZZ	35,000	72,000	26,987	0,44	1	NTN
63208LLB	40,000	80,000	30,162	0,60	1	NTN
63208LLU	40,000	80,000	30,200	0,60	1	NTN
63208ZZ	40,000	80,000	30,162	0,60	1	NTN
63209LLB	45,000	85,000	30,162	0,63	1	NTN
63209LLU	45,000	85,000	30,162	0,63	1	NTN
63209ZZ	45,000	85,000	30,162	0,63	1	NTN
6320LLB	100,000	215,000	47,000	7,19	1	NTN
6320LLU	100,000	215,000	47,000	7,19	1	NTN
6320Z	100,000	215,000	47,000	7,10	1	NTN
6320ZZ	100,000	215,000	47,000	7,00	1	NTN-SNR
6321	105,000	225,000	49,000	8,05	1	NTN
63210LLB	50,000	90,000	30,162	0,68	1	NTN
63210LLU	50,000	90,000	30,162	0,68	1	NTN
63210ZZ	50,000	90,000	30,162	0,68	1	NTN
63211LLB	55,000	100,000	33,300	0,94	1	NTN
63214ZZ	70,000	125,000	39,700	1,77	1	NTN
6321LLU	105,000	225,000	49,000	8,19	1	NTN
6321Z	105,000	225,000	49,000	8,05	1	NTN
6321ZZ	105,000	225,000	49,000	8,19	1	NTN
6322	110,000	240,000	50,000	9,54	1	NTN-SNR
6322D2	110,000	240,000	100,000	19,80	1	NTN
6322LLB	110,000	240,000	50,000	9,54	1	NTN
6322LLU	110,000	240,000	50,000	9,66	1	NTN
6322Z	110,000	240,000	50,000	9,56	1	NTN
6322ZZ	110,000	240,000	50,000	9,64	1	NTN
6324	120,000	260,000	55,000	12,40	1	NTN
6324LLU	120,000	260,000	55,000	12,70	1	NTN
6324M	120,000	260,000	55,000	14,48	1	SNR
6324Z	120,000	260,000	55,000	12,40	1	NTN
6324ZZ	120,000	260,000	55,000	12,70	1	NTN
6326	130,000	280,000	58,000	15,30	1	NTN
6326LLU	130,000	280,000	58,000	15,50	1	NTN
6326M	130,000	280,000	58,000	18,12	1	SNR
6326Z	130,000	280,000	58,000	15,20	1	NTN
6326ZZ	130,000	280,000	58,000	15,30	1	NTN
6328	140,000	300,000	62,000	18,50	1	NTN
6328B	140,000	300,000	62,000	21,60	1	NTN
6328LLU	140,000	300,000	62,000	18,80	1	NTN
6328M	140,000	300,000	62,000	22,10	1	SNR
6328Z	140,000	300,000	62,000	18,52	1	NTN
6328ZZ	140,000	300,000	62,000	18,60	1	NTN
6330	150,000	320,000	65,000	23,00	1	NTN
63304LLB	20,000	52,000	22,200	0,21	1	NTN



Reference	d	D	B	Kg		Brands
63304LLU	20,000	52,000	22,200	0,21	1	NTN
63304ZZ	20,000	52,000	22,200	0,21	1	NTN
63305LLB	25,000	62,000	25,400	0,34	1	NTN
63305LLU	25,000	62,000	25,400	0,34	1	NTN
63305ZZ	25,000	62,000	25,400	0,34	1	NTN
63306LLB	30,000	72,000	30,162	0,54	1	NTN
63306LLU	30,000	72,000	30,200	0,54	1	NTN
63306ZZ	30,000	72,000	30,162	0,54	1	NTN
63307LLB	35,000	80,000	34,900	0,75	1	NTN
63307LLU	35,000	80,000	34,900	0,75	1	NTN
63307ZZ	35,000	80,000	34,900	0,75	1	NTN
63308LLB	40,000	90,000	36,500	0,99	1	NTN
63308LLU	40,000	90,000	36,500	0,99	1	NTN
63308ZZ	40,000	90,000	36,500	0,99	1	NTN
63309LLB	45,000	100,000	39,700	1,26	1	NTN
63309LLU	45,000	100,000	39,700	1,28	1	NTN
63309ZZ	45,000	100,000	39,687	1,27	1	NTN
6330M	150,000	320,000	65,000	26,60	1	SNR
6330Z	150,000	320,000	65,000	23,00	1	NTN
6330ZZ	150,000	320,000	65,000	23,30	1	NTN
63310LLB	50,000	110,000	44,400	1,71	1	NTN
63310LLU	50,000	110,000	44,400	1,71	1	NTN
63310ZZ	50,000	110,000	44,400	1,71	1	NTN
63311LLB	55,000	120,000	49,200	2,21	1	NTN
63311LLU	55,000	120,000	49,200	2,21	1	NTN
63311ZZ	55,000	120,000	49,200	2,20	1	NTN
63312LLB	60,000	130,000	53,975	2,85	1	NTN
63312LLU	60,000	130,000	53,975	2,86	1	NTN
63312ZZ	60,000	130,000	53,975	2,85	1	NTN
63313LLB	65,000	140,000	58,700	3,59	1	NTN
63313LLU	65,000	140,000	58,700	3,59	1	NTN
63313ZZ	65,000	140,000	58,700	3,59	1	NTN
63314LLB	70,000	150,000	63,500	4,48	1	NTN
63314ZZ	70,000	150,000	63,500	4,45	1	NTN
63315LLB	75,000	160,000	68,262	5,44	1	NTN
63316LLU	80,000	170,000	68,300	6,17	1	NTN
63316ZZ	80,000	170,000	68,262	6,17	1	NTN
63317ZZ	85,000	180,000	73,000	7,34	1	NTN
6332	160,000	340,000	68,000	26,00	1	NTN
63320LLB	100,000	215,000	82,600	13,60	1	NTN
63320ZZ	100,000	215,000	82,500	12,14	1	NTN
6332M	160,000	340,000	68,000	31,50	1	SNR
6334	170,000	360,000	72,000	30,80	1	NTN
6334K	170,000	360,000	72,000	30,30	1	NTN
6336	180,000	380,000	75,000	37,00	1	NTN
6338	190,000	400,000	78,000	41,00	1	NTN
634	4,000	16,000	5,000	0,01	1	NTN-SNR

Reference	d	D	B	Kg		Brands
6340	200,000	420,000	80,000	47,50	1	NTN
6344	220,000	460,000	88,000	60,80	1	NTN
6348	240,000	500,000	95,000	76,10	1	NTN
634EE	4,000	16,000	5,000	0,01	1	SNR
634Z	4,000	16,000	5,000	0,01	1	NTN
634ZZ	4,000	16,000	5,000	0,01	1	NTN-SNR
635	5,000	19,000	6,000	0,01	1	NTN
6352	260,000	540,000	102,000	116,00	1	NTN
6356	280,000	580,000	108,000	142,00	1	NTN
635LLB	5,000	19,000	6,000	0,01	1	NTN
635LLU	5,000	19,000	6,000	0,01	1	NTN
635ZZ	5,000	19,000	6,000	0,01	1	NTN-SNR
638Z	8,000	28,000	9,000	0,03	1	NTN
638ZZ	8,000	28,000	9,000	0,03	1	NTN
6403	17,000	62,000	17,000	0,26	1	NTN-SNR
6403ZZ	17,000	62,000	17,000	0,27	1	NTN
6404	20,000	72,000	19,000	0,40	1	NTN-SNR
6404Z	20,000	72,000	19,000	0,40	1	NTN
6404ZZ	20,000	72,000	19,000	0,41	1	NTN
6405	25,000	80,000	21,000	0,53	1	NTN-SNR
6405Z	25,000	80,000	21,000	0,51	1	NTN
6405ZZ	25,000	80,000	21,000	0,53	1	NTN
6406	30,000	90,000	23,000	0,74	1	NTN-SNR
6406ZZ	30,000	90,000	23,000	0,74	1	NTN
6407	35,000	100,000	25,000	0,95	1	NTN-SNR
6407Z	35,000	100,000	25,000	0,96	1	NTN
6407ZZ	35,000	100,000	25,000	0,96	1	NTN
6408	40,000	110,000	27,000	1,23	1	NTN-SNR
6408NR	40,000	110,000	27,000	1,26	1-NR	NTN
6408ZZ	40,000	110,000	27,000	1,25	1	NTN
6409	45,000	120,000	29,000	1,53	1	NTN-SNR
6409NR	45,000	120,000	29,000	1,49	1-NR	NTN
6409ZZ	45,000	120,000	29,000	1,53	1	NTN
6410	50,000	130,000	31,000	1,88	1	NTN-SNR
6410NR	50,000	130,000	31,000	1,86	1-NR	NTN
6410ZZ	50,000	130,000	31,000	1,53	1	NTN
6411	55,000	140,000	33,000	2,34	1	NTN-SNR
6411N	55,000	140,000	33,000	2,30	1-NR	SNR
6411NR	55,000	140,000	33,000	2,28	1-NR	NTN-SNR
6411ZZ	55,000	140,000	33,000	2,35	1	NTN
6412	60,000	150,000	35,000	2,77	1	NTN-SNR
6412NR	60,000	150,000	35,000	2,75	1-NR	NTN
6412ZZ	60,000	150,000	35,000	2,84	1	NTN
6413	65,000	160,000	37,000	3,36	1	NTN-SNR
6413NR	65,000	160,000	37,000	3,29	1-NR	NTN
6414	70,000	180,000	42,000	4,83	1	NTN-SNR
6414D2	70,000	180,000	84,000	9,62	1	NTN
6415	75,000	190,000	45,000	5,89	1	NTN

Reference	d	D	B	Kg	?	Brands
6416	80,000	200,000	48,000	6,76	1	NTN
6416M	80,000	200,000	48,000	8,07	1	SNR
6417	85,000	210,000	52,000	7,98	1	NTN
6418	90,000	225,000	54,000	9,56	1	NTN
6420	100,000	250,000	58,000	13,06	1	NTN
6426	130,000	340,000	78,000	32,00	1	NTN
67/25	2,500	5,000	1,500	0,11	1	NTN
6700	10,000	15,000	3,000	0,001	1	NTN
6701	12,000	18,000	4,000	0,002	1	NTN
6701LLF	12,000	18,000	4,000	0,003	1	NTN
6701ZZ	12,000	18,000	4,000	0,003	1	NTN
6702	15,000	21,000	4,000	0,003	1	NTN
6702LLF	15,000	21,000	4,000	0,003	1	NTN
6703	17,000	23,000	4,000	0,003	1	NTN
6703LLF	17,000	23,000	4,000	0,004	1	NTN
6704	20,000	27,000	4,000	0,01	1	NTN
6704LLF	20,000	27,000	4,000	0,01	1	NTN
6704ZZ	20,000	27,000	4,000	0,005	1	NTN
6705	25,000	32,000	4,000	0,01	1	NTN
6705LLF	25,000	32,000	4,000	0,01	1	NTN
6706	30,000	37,000	4,000	0,01	1	NTN
6706LLF	30,000	37,000	4,000	0,01	1	NTN
6707	35,000	44,000	5,000	0,02	1	NTN
6707LLF	35,000	44,000	5,000	0,02	1	NTN
6708	40,000	50,000	6,000	0,02	1	NTN
672	2,000	4,000	1,200	0,001	1	NTN
673	3,000	6,000	2,000	0,001	1	NTN
674A	4,000	7,000	2,000	0,28	1	NTN
675	5,000	8,000	2,000	0,002	1	NTN
676A	6,000	10,000	2,500	0,65	1	NTN
677	7,000	11,000	2,500	0,003	1	NTN
678A	8,000	12,000	2,500	0,75	1	NTN
679	9,000	14,000	3,000	0,004	1	NTN
679/16	9,000	16,000	3,000	2,36	1	NTN
68/1000	1 000,000	1 220,000	100,000	237,00	1	NTN
68/1060	1 060,000	1 280,000	100,000	214,00	1	NTN
68/1120	1 120,000	1 360,000	106,000	307,00	1	NTN
68/1180	1 180,000	1 420,000	106,000	322,00	1	NTN
68/1250	1 250,000	1 500,000	112,000	376,00	1	NTN
68/1320	1 320,000	1 600,000	122,000	495,00	1	NTN
68/15	1,500	4,000	1,200	0,07	1	NTN
68/22ZZ	22,000	34,000	7,000	0,02	1	NTN
68/25	2,500	6,000	1,800	0,22	1	NTN
68/500	500,000	620,000	56,000	36,74	1	NTN
68/530	530,000	650,000	56,000	39,50	1	NTN
68/560	560,000	680,000	56,000	40,20	1	NTN
68/600	600,000	730,000	60,000	51,70	1	NTN
68/630	630,000	780,000	69,000	71,60	1	NTN
68/670	670,000	820,000	69,000	75,10	1	NTN
68/710	710,000	870,000	74,000	92,60	1	NTN
68/750	750,000	920,000	78,000	107,00	1	NTN
68/800	800,000	980,000	82,000	127,00	1	NTN

Reference	d	D	B	Kg	?	Brands
68/850	850,000	1 030,000	82,000	135,00	1	NTN
68/850/1080	850,000	1 080,000	82,000	195,00	1	NTN
68/900	900,000	1 090,000	85,000	156,00	1	NTN
68/950	950,000	1 150,000	90,000	184,00	1	NTN
68/950/1200	950,000	1 200,000	90,000	258,00	1	NTN
6800	10,000	19,000	5,000	0,01	1	NTN
6800LLB	10,000	19,000	5,000	0,01	1	NTN
6800LLU	10,000	19,000	5,000	0,01	1	NTN
6800LUZ	10,000	19,000	5,000	0,01	1	NTN
6800Z	10,000	19,000	5,000	0,01	1	NTN
6800ZZ	10,000	19,000	5,000	0,01	1	NTN
6801	12,000	21,000	5,000	0,01	1	NTN
6801LBU	12,000	21,000	5,000	0,01	1	NTN
6801LLB	12,000	21,000	5,000	0,01	1	NTN
6801LLU	12,000	21,000	5,000	0,01	1	NTN
6801Z	12,000	21,000	5,000	0,01	1	NTN
6801ZZ	12,000	21,000	5,000	0,01	1	NTN
6802	15,000	24,000	5,000	0,01	1	NTN
6802LLB	15,000	24,000	5,000	0,01	1	NTN
6802LLU	15,000	24,000	5,000	0,01	1	NTN
6802Z	15,000	24,000	5,000	0,01	1	NTN
6802ZZ	15,000	24,000	5,000	0,01	1	NTN
6803	17,000	26,000	5,000	0,01	1	NTN
6803LB	17,000	26,000	5,000	0,01	1	NTN
6803LLB	17,000	26,000	5,000	0,01	1	NTN
6803LLU	17,000	26,000	5,000	0,01	1	NTN
6803Z	17,000	26,000	5,000	0,01	1	NTN
6803ZZ	17,000	26,000	5,000	0,01	1	NTN
6804	20,000	32,000	7,000	0,02	1	NTN
6804LLB	20,000	32,000	7,000	0,02	1	NTN
6804LLU	20,000	32,000	7,000	0,02	1	NTN
6804LLUNR	20,000	32,000	7,000	0,02	1-NR	NTN
6804LU	20,000	32,000	7,000	0,02	1	NTN
6804NR	20,000	32,000	7,000	0,02	1-NR	NTN
6804Z	20,000	32,000	7,000	0,02	1	NTN
6804ZZ	20,000	32,000	7,000	0,02	1	NTN
6804ZZ/42	20,000	42,000	7,000	0,05	1	NTN
6804ZZNR	20,000	32,000	7,000	0,02	1-NR	NTN
6805	25,000	37,000	7,000	0,02	1	NTN
6805LBU	25,000	37,000	7,000	0,02	1	NTN
6805LLB	25,000	37,000	7,000	0,02	1	NTN
6805LLU	25,000	37,000	7,000	0,02	1	NTN
6805LLUN	25,000	37,000	7,000	0,02	1-NR	NTN
6805LU	25,000	37,000	7,000	0,02	1	NTN
6805Z	25,000	37,000	7,000	0,02	1	NTN
6805ZZ	25,000	37,000	7,000	0,02	1	NTN
6805ZZNR	25,000	37,000	7,000	0,02	1-NR	NTN
6806	30,000	42,000	7,000	0,03	1	NTN
6806LLB	30,000	42,000	7,000	0,02	1	NTN
6806LLH	30,000	42,000	7,000	0,02	1	NTN
6806LLU	30,000	42,000	7,000	0,02	1	NTN
6806LLUN	30,000	42,000	7,000	0,02	1-NR	NTN
6806LLUNR	30,000	42,000	7,000	0,02	1-NR	NTN
6806ZZ	30,000	42,000	7,000	0,02	1	NTN
6806ZZNR	30,000	42,000	7,000	0,02	1-NR	NTN



Reference	d	D	B	Kg	?	Brands
6807	35,000	47,000	7,000	0,03	1	NTN
6807LLB	35,000	47,000	7,000	0,03	1	NTN
6807LLU	35,000	47,000	7,000	0,03	1	NTN
6807NR	35,000	47,000	7,000	0,03	1-NR	NTN
6807ZZ	35,000	47,000	7,000	0,03	1	NTN
6807ZZNR	35,000	47,000	7,000	0,03	1-NR	NTN
6808	40,000	52,000	7,000	0,03	1	NTN
6808LB	40,000	52,000	7,000	0,03	1	NTN
6808LLB	40,000	52,000	7,000	0,03	1	NTN
6808LLU	40,000	52,000	7,000	0,03	1	NTN
6808ZZ	40,000	52,000	7,000	0,03	1	NTN
6808ZZNR	40,000	52,000	7,000	0,03	1-NR	NTN
6809	45,000	58,000	7,000	0,03	1	NTN
6809D2	45,000	58,000	14,000	0,08	1	NTN
6809LLB	45,000	58,000	7,000	0,03	1	NTN
6809LLU	45,000	58,000	7,000	0,04	1	NTN
6809Z	45,000	58,000	7,000	0,03	1	NTN
6809ZZ	45,000	58,000	7,000	0,03	1	NTN
6810	50,000	65,000	7,000	0,05	1	NTN
6810LLB	50,000	65,000	7,000	0,05	1	NTN
6810LLU	50,000	65,000	7,000	0,05	1	NTN
6810ZZ	50,000	65,000	7,000	0,05	1	NTN
6811	55,000	72,000	9,000	0,08	1	NTN
6811LLB	55,000	72,000	9,000	0,08	1	NTN
6811LLU	55,000	72,000	9,000	0,08	1	NTN
6811LU	55,000	72,000	9,000	0,08	1	NTN
6811ZZ	55,000	72,000	9,000	0,08	1	NTN
6812	60,000	78,000	10,000	0,11	1	NTN
6812LLB	60,000	78,000	10,000	0,10	1	NTN
6812LLH	60,000	78,000	10,000	0,10	1	NTN
6812LLU	60,000	78,000	10,000	0,10	1	NTN
6812LU	60,000	78,000	10,000	0,10	1	NTN
6812ZZ	60,000	78,000	10,000	0,10	1	NTN
6813	65,000	85,000	10,000	0,13	1	NTN
6813LLB	65,000	85,000	10,000	0,12	1	NTN
6813LLU	65,000	85,000	10,000	0,12	1	NTN
6813ZZ	65,000	85,000	10,000	0,12	1	NTN
6814	70,000	90,000	10,000	0,14	1	NTN
6814LH	70,000	90,000	10,000	0,13	1	NTN
6814LLB	70,000	90,000	10,000	0,13	1	NTN
6814LLU	70,000	90,000	10,000	0,13	1	NTN
6814LU	70,000	90,000	10,000	0,13	1	NTN
6814ZZ	70,000	90,000	10,000	0,13	1	NTN
6815	75,000	95,000	10,000	0,14	1	NTN
6815LLB	75,000	95,000	10,000	0,14	1	NTN
6815LLU	75,000	95,000	10,000	0,14	1	NTN
6815ZZ	75,000	95,000	10,000	0,14	1	NTN
6816	80,000	100,000	10,000	0,15	1	NTN
6816LLB	80,000	100,000	10,000	0,15	1	NTN
6816LLU	80,000	100,000	10,000	0,15	1	NTN
6816ZZ	80,000	100,000	10,000	0,15	1	NTN
6817	85,000	110,000	13,000	0,26	1	NTN

Reference	d	D	B	Kg	?	Brands
6817LLB	85,000	110,000	13,000	0,26	1	NTN
6817LLU	85,000	110,000	13,000	0,26	1	NTN
6817ZZ	85,000	110,000	13,000	0,26	1	NTN
6818	90,000	115,000	13,000	0,29	1	NTN
6818LLB	90,000	115,000	13,000	0,27	1	NTN
6818LLU	90,000	115,000	13,000	0,27	1	NTN
6818ZZ	90,000	115,000	13,000	0,27	1	NTN
6819	95,000	120,000	13,000	0,29	1	NTN
6819LLB	95,000	120,000	13,000	0,28	1	NTN
6819LLU	95,000	120,000	13,000	0,28	1	NTN
6819ZZ	95,000	120,000	13,000	0,28	1	NTN
682	2,000	5,000	1,500	0,001	1	NTN
6820	100,000	125,000	13,000	0,31	1	NTN
6820LLB	100,000	125,000	13,000	0,30	1	NTN
6820LLU	100,000	125,000	13,000	0,30	1	NTN
6820ZZ	100,000	125,000	13,000	0,29	1	NTN
6821	105,000	130,000	13,000	0,31	1	NTN
6821LLU	105,000	130,000	13,000	0,31	1	NTN
6821ZZ	105,000	130,000	13,000	0,30	1	NTN
6822	110,000	140,000	16,000	0,51	1	NTN
6822LLB	110,000	140,000	16,000	0,50	1	NTN
6822LLU	110,000	140,000	16,000	0,50	1	NTN
6822ZZ	110,000	140,000	16,000	0,49	1	NTN
6824	120,000	150,000	16,000	0,55	1	NTN
6824LLU	120,000	150,000	16,000	0,54	1	NTN
6824NR	120,000	150,000	16,000	0,55	1-NR	NTN
6824ZZ	120,000	150,000	16,000	0,52	1	NTN
6826	130,000	165,000	18,000	0,77	1	NTN
6826LLB	130,000	165,000	18,000	0,74	1	NTN
6826LLU	130,000	165,000	18,000	0,75	1	NTN
6826ZZ	130,000	165,000	18,000	0,72	1	NTN
6828	140,000	175,000	18,000	0,85	1	NTN
6828LLU	140,000	175,000	18,000	0,80	1	NTN
6828ZZ	140,000	175,000	18,000	0,81	1	NTN
683	3,000	7,000	2,000	0,001	1	NTN
6830	150,000	190,000	20,000	1,13	1	NTN
6830ZZ	150,000	190,000	20,000	1,12	1	NTN
6832	160,000	200,000	20,000	1,21	1	NTN
6832LLU	160,000	200,000	20,000	1,18	1	NTN
6832ZZ	160,000	200,000	20,000	1,19	1	NTN
6834	170,000	215,000	22,000	1,63	1	NTN
6834ZZ	170,000	215,000	22,000	1,19	1	NTN
6836	180,000	225,000	22,000	1,96	1	NTN
6836AZZ	180,000	225,000	22,000	1,96	1	NTN
6838	190,000	240,000	24,000	2,62	1	NTN
6840	200,000	250,000	24,000	2,69	1	NTN
6840ALLU	200,000	250,000	24,000	2,52	1	NTN
6844	220,000	270,000	24,000	3,00	1	NTN

Reference	d	D	B	Kg		Brands
6848	240,000	300,000	28,000	4,51	1	NTN
6848C	240,000	300,000	28,000	3,78	1	NTN
6848LLB	240,000	300,000	28,000	4,13	1	NTN
684AX50	4,000	9,000	2,500	0,67	1	NTN
685	5,000	11,000	3,000	0,001	1	NTN
6852	260,000	320,000	28,000	5,00	1	NTN
6856	280,000	350,000	33,000	6,10	1	NTN
686	6,000	13,000	3,500	0,002	1	NTN
6860	300,000	380,000	38,000	10,50	1	NTN
6864	320,000	400,000	38,000	10,84	1	NTN
6868	340,000	420,000	38,000	11,50	1	NTN
6872	360,000	440,000	38,000	17,00	1	NTN
6876	380,000	480,000	46,000	19,70	1	NTN
687A	7,000	14,000	3,500	2,10	1	NTN
6880	400,000	500,000	46,000	20,50	1	NTN
6884	420,000	520,000	46,000	21,60	1	NTN
6884D2	420,000	520,000	145,000	59,00	1	NTN
6888	440,000	540,000	46,000	21,62	1	NTN
688A	8,000	16,000	4,000	3,10	1	NTN
689	9,000	17,000	4,000	0,003	1	NTN
6892	460,000	580,000	56,000	34,80	1	NTN
6892D2	460,000	580,000	180,000	101,00	1	NTN
6896	480,000	600,000	56,000	35,10	1	NTN
69/1000	1 000,000	1 320,000	140,000	506,00	1	NTN
69/1060	1 060,000	1 400,000	150,000	610,00	1	NTN
69/1120	1 120,000	1 460,000	150,000	640,00	1	NTN
69/1180	1 180,000	1 540,000	160,000	762,00	1	NTN
69/15A	1,500	5,000	2,000	0,18	1	NTN
69/22	22,000	39,000	9,000	0,04	1	NTN
69/25	2,500	7,000	2,500	0,43	1	NTN
69/500	500,000	670,000	78,000	75,50	1	NTN
69/530	530,000	710,000	82,000	89,10	1	NTN
69/560	560,000	750,000	85,000	101,40	1	NTN
69/600	600,000	800,000	90,000	122,00	1	NTN
69/630	630,000	850,000	100,000	158,00	1	NTN
69/670	670,000	900,000	103,000	178,20	1	NTN
69/710	710,000	950,000	106,000	205,00	1	NTN
69/750	750,000	1 000,000	112,000	238,00	1	NTN
69/800	800,000	1 060,000	115,000	272,00	1	NTN
69/850	850,000	1 120,000	118,000	311,50	1	NTN
69/900	900,000	1 180,000	122,000	346,00	1	NTN
69/950	950,000	1 250,000	132,000	424,00	1	NTN
6900	10,000	22,000	6,000	0,01	1	NTN
6900LLB	10,000	22,000	6,000	0,01	1	NTN
6900LLU	10,000	22,000	6,000	0,01	1	NTN
6900LLUNR	10,000	22,000	6,000	0,01	1-NR	NTN
6900NR	10,000	22,000	6,000	0,01	1-NR	NTN
6900Z	10,000	22,000	6,000	0,01	1	NTN
6900ZZ	10,000	22,000	6,000	0,01	1	NTN
6900ZZN	10,000	22,000	6,000	0,01	1-NR	NTN
6900ZZNR	10,000	22,000	6,000	0,01	1-NR	NTN
6901	12,000	24,000	6,000	0,01	1	NTN
6901LLB	12,000	24,000	6,000	0,01	1	NTN

Reference	d	D	B	Kg		Brands
6901LLU	12,000	24,000	6,000	0,01	1	NTN
6901LLUN	12,000	24,000	6,000	0,01	1-NR	NTN
6901LLUNR	12,000	24,000	6,000	0,01	1-NR	NTN
6901LU	12,000	24,000	6,000	0,01	1	NTN
6901N	12,000	24,000	6,000	0,01	1-NR	NTN
6901NR	12,000	24,000	6,000	0,01	1-NR	NTN
6901Z	12,000	24,000	6,000	0,01	1	NTN
6901ZZ	12,000	24,000	6,000	0,01	1	NTN
6901ZZNR	12,000	24,000	6,000	0,01	1-NR	NTN
6902	15,000	28,000	7,000	0,02	1	NTN
6902LLB	15,000	28,000	7,000	0,02	1	NTN
6902LLH	15,000	28,000	7,000	0,02	1	NTN
6902LLU	15,000	28,000	7,000	0,02	1	NTN
6902LLUNR	15,000	28,000	7,000	0,02	1-NR	NTN
6902LU	15,000	28,000	7,000	0,02	1	NTN
6902NR	15,000	28,000	7,000	0,02	1-NR	NTN
6902Z	15,000	28,000	7,000	0,02	1	NTN
6902ZZ	15,000	28,000	7,000	0,02	1	NTN
6902ZZNR	15,000	28,000	7,000	0,02	1-NR	NTN
6903	17,000	30,000	7,000	0,01	1	NTN
6903LLB	17,000	30,000	7,000	0,02	1	NTN
6903LLU	17,000	30,000	7,000	0,02	1	NTN
6903LLUNR	17,000	30,000	7,000	0,02	1-NR	NTN
6903Z	17,000	30,000	7,000	0,02	1	NTN
6903ZZ	17,000	30,000	7,000	0,02	1	NTN
6903ZZNR	17,000	30,000	7,000	0,02	1-NR	NTN
6904	20,000	37,000	9,000	0,04	1	NTN
6904LB	20,000	37,000	9,000	0,04	1	NTN
6904LLB	20,000	37,000	9,000	0,03	1	NTN
6904LLU	20,000	37,000	9,000	0,03	1	NTN
6904LLUNR	20,000	37,000	9,000	0,03	1-NR	NTN
6904LU	20,000	37,000	9,000	0,03	1	NTN
6904NR	20,000	37,000	9,000	0,04	1-NR	NTN
6904Z	20,000	37,000	9,000	0,03	1	NTN
6904ZZ	20,000	37,000	9,000	0,03	1	NTN
6904ZZNR	20,000	37,000	9,000	0,04	1-NR	NTN
6905	25,000	42,000	7,000	0,04	1	NTN
6905/257	25,700	42,000	9,000	0,04	1	NTN
6905LLB	25,000	42,000	9,000	0,04	1	NTN
6905LLH	25,000	42,000	9,000	0,04	1	NTN
6905LLU	25,000	42,000	9,000	0,04	1	NTN
6905LLUNR	25,000	42,000	9,000	0,04	1-NR	NTN
6905LU	25,000	42,000	9,000	0,04	1	NTN
6905NR	25,000	42,000	9,000	0,04	1-NR	NTN
6905Z	25,000	42,000	9,000	0,04	1	NTN
6905ZZ	25,000	42,000	9,000	0,04	1	NTN
6905ZZNR	25,000	42,000	9,000	0,04	1-NR	NTN
6906	30,000	47,000	9,000	0,05	1	NTN
6906/28	28,000	47,000	9,000	0,06	1	NTN
6906LB	30,000	47,000	9,000	0,05	1	NTN
6906LLB	30,000	47,000	9,000	0,05	1	NTN
6906LLH	30,000	47,000	9,000	0,04	1	NTN
6906LLU	30,000	47,000	9,000	0,04	1	NTN
6906LU	30,000	47,000	9,000	0,04	1	NTN
6906NR	30,000	47,000	9,000	0,05	1-NR	NTN
6906Z	30,000	47,000	9,000	0,04	1	NTN
6906ZZ	30,000	47,000	9,000	0,04	1	NTN



Reference	d	D	B	Kg		Brands
6906ZZN	30,000	47,000	9,000	0,05	1-NR	NTN
6906ZZNR	30,000	47,000	9,000	0,05	1-NR	NTN
6907	35,000	55,000	10,000	0,08	1	NTN
6907LLB	35,000	55,000	10,000	0,07	1	NTN
6907LLB/361	36,100	55,000	10,000	0,07	1	NTN
6907LLU	35,000	55,000	10,000	0,07	1	NTN
6907LU	35,000	55,000	10,000	0,07	1	NTN
6907LU/34	34,000	55,000	10,000	0,08	1	NTN
6907NR	35,000	55,000	10,000	0,07	1-NR	NTN
6907XLLH	35,000	55,000	10,000	0,07	1	NTN
6907Z	35,000	55,000	10,000	0,07	1	NTN
6907ZZ	35,000	55,000	10,000	0,07	1	NTN
6907ZZNR	35,000	55,000	10,000	0,08	1-NR	NTN
6908	40,000	62,000	12,000	0,11	1	NTN
6908LLB	40,000	62,000	12,000	0,11	1	NTN
6908LLH	40,000	62,000	12,000	0,11	1	NTN
6908LLU	40,000	62,000	12,000	0,11	1	NTN
6908LU	40,000	62,000	12,000	0,11	1	NTN
6908NR	40,000	62,000	12,000	0,11	1-NR	NTN
6908Z	40,000	62,000	12,000	0,11	1	NTN
6908ZZ	40,000	62,000	12,000	0,11	1	NTN
6908ZZNR	40,000	62,000	12,000	0,11	1-NR	NTN
6909	45,000	68,000	12,000	0,14	1	NTN
6909D2	45,000	68,000	24,000	0,27	1	NTN
6909LLB	45,000	68,000	12,000	0,13	1	NTN
6909LLU	45,000	68,000	12,000	0,13	1	NTN
6909LU	45,000	68,000	12,000	0,13	1	NTN
6909Z	45,000	68,000	12,000	0,13	1	NTN
6909ZZ	45,000	68,000	12,000	0,14	1	NTN
6909ZZNR	45,000	68,000	12,000	0,14	1-NR	NTN
6910	50,000	72,000	12,000	0,13	1	NTN
6910LLB	50,000	72,000	12,000	0,14	1	NTN
6910LLU	50,000	72,000	12,000	0,13	1	NTN
6910Z	50,000	72,000	12,000	0,13	1	NTN
6910ZZ	50,000	72,000	12,000	0,13	1	NTN
6910ZZNR	50,000	72,000	12,000	0,13	1-NR	NTN
6911	55,000	80,000	13,000	0,18	1	NTN
6911LLB	55,000	80,000	13,000	0,18	1	NTN
6911LLU	55,000	80,000	13,000	0,18	1	NTN
6911NR	55,000	80,000	13,000	0,19	1-NR	NTN
6911Z	55,000	80,000	13,000	0,18	1	NTN
6911ZZ	55,000	80,000	13,000	0,18	1	NTN
6911ZZNR	55,000	80,000	13,000	0,18	1-NR	NTN
6912	60,000	85,000	13,000	0,19	1	NTN
6912LLB	60,000	85,000	13,000	0,19	1	NTN
6912LLU	60,000	85,000	13,000	0,19	1	NTN
6912LU	60,000	85,000	13,000	0,19	1	NTN
6912Z	60,000	85,000	13,000	0,19	1	NTN
6912ZZ	60,000	85,000	13,000	0,19	1	NTN
6912ZZNR	60,000	85,000	13,000	0,19	1-NR	NTN
6913	65,000	90,000	13,000	0,19	1	NTN
6913LLB	65,000	90,000	13,000	0,21	1	NTN
6913LLU	65,000	90,000	13,000	0,21	1	NTN
6913Z	65,000	90,000	13,000	0,19	1	NTN
6913ZZ	65,000	90,000	13,000	0,20	1	NTN

Reference	d	D	B	Kg		Brands
6913ZZNR	65,000	90,000	13,000	0,21	1-NR	NTN
6914	70,000	100,000	16,000	0,33	1	NTN
6914LLB	70,000	100,000	16,000	0,33	1	NTN
6914LLU	70,000	100,000	16,000	0,33	1	NTN
6914ZZ	70,000	100,000	16,000	0,32	1	NTN
6915	75,000	105,000	16,000	0,36	1	NTN
6915LLB	75,000	105,000	16,000	0,35	1	NTN
6915LLU	75,000	105,000	16,000	0,34	1	NTN
6915LU	75,000	105,000	16,000	0,36	1	NTN
6915Z	75,000	105,000	16,000	0,33	1	NTN
6915ZZ	75,000	105,000	16,000	0,34	1	NTN
6916	80,000	110,000	16,000	0,37	1	NTN
6916LLB	80,000	110,000	16,000	0,36	1	NTN
6916LLU	80,000	110,000	16,000	0,37	1	NTN
6916ZZ	80,000	110,000	16,000	0,36	1	NTN
6917	85,000	120,000	18,000	0,54	1	NTN
6917LLU	85,000	120,000	18,000	0,53	1	NTN
6917NR	85,000	120,000	18,000	0,53	1-NR	NTN
6917ZZ	85,000	120,000	18,000	0,53	1	NTN
6918	90,000	125,000	18,000	0,55	1	NTN
6918LLB	90,000	125,000	18,000	0,56	1	NTN
6918LLBD2	90,000	125,000	36,000	1,13	1	NTN
6918LLU	90,000	125,000	18,000	0,56	1	NTN
6918Z	90,000	125,000	18,000	0,54	1	NTN
6918ZZ	90,000	125,000	18,000	0,56	1	NTN
6919	95,000	130,000	18,000	0,58	1	NTN
6919LLB	95,000	130,000	18,000	0,59	1	NTN
6919LLU	95,000	130,000	18,000	0,58	1	NTN
6919LUZ	95,000	130,000	18,000	0,58	1	NTN
6919ZZ	95,000	130,000	18,000	0,58	1	NTN
692	2,000	6,000	2,300	0,001	1	NTN
6920	100,000	140,000	20,000	0,78	1	NTN
6920LLB	100,000	140,000	20,000	0,79	1	NTN
6920LLU	100,000	140,000	20,000	0,80	1	NTN
6920NR	100,000	140,000	20,000	0,81	1-NR	NTN
6920Z	100,000	140,000	20,000	0,78	1	NTN
6920ZZ	100,000	140,000	20,000	0,79	1	NTN
6921	105,000	145,000	20,000	0,84	1	NTN
6921LLB	105,000	145,000	20,000	0,84	1	NTN
6921LLU	105,000	145,000	20,000	0,84	1	NTN
6921ZZ	105,000	145,000	20,000	0,83	1	NTN
6922	110,000	150,000	20,000	0,85	1	NTN
6922LLB	110,000	150,000	20,000	0,86	1	NTN
6922LLU	110,000	150,000	20,000	0,87	1	NTN
6922Z	110,000	150,000	20,000	0,87	1	NTN
6922ZZ	110,000	150,000	20,000	0,86	1	NTN
6924	120,000	165,000	22,000	1,19	1	NTN
6924LLU	120,000	165,000	22,000	1,19	1	NTN
6924NR	120,000	165,000	22,000	1,19	1-NR	NTN
6924ZZ	120,000	165,000	22,000	1,19	1	NTN
6926	130,000	180,000	24,000	1,52	1	NTN

Reference	d	D	B	Kg	?	Brands
6926LLU	130,000	180,000	24,000	1,56	1	NTN
6926LU	130,000	180,000	24,000	1,54	1	NTN
6926LUZ	130,000	180,000	24,000	1,55	1	NTN
6926Z	130,000	180,000	24,000	1,54	1	NTN
6926ZZ	130,000	180,000	24,000	1,55	1	NTN
6928	140,000	190,000	24,000	1,62	1	NTN
6928LLU	140,000	190,000	24,000	1,64	1	NTN
6928LU	140,000	190,000	24,000	1,67	1	NTN
6928ZZ	140,000	190,000	24,000	1,65	1	NTN
693	3,000	8,000	3,000	0,001	1	NTN
6930	150,000	210,000	28,000	2,47	1	NTN
6930LLU	150,000	210,000	28,000	2,57	1	NTN
6930Z	150,000	210,000	28,000	2,47	1	NTN
6930ZZ	150,000	210,000	28,000	2,55	1	NTN
6932	160,000	220,000	28,000	2,61	1	NTN
6932LLU	160,000	220,000	28,000	2,72	1	NTN
6932Z	160,000	220,000	28,000	2,61	1	NTN
6932ZZ	160,000	220,000	28,000	2,61	1	NTN
6934	170,000	230,000	28,000	2,74	1	NTN
6934Z	170,000	230,000	28,000	2,74	1	NTN
6934ZZ	170,000	230,000	28,000	2,90	1	NTN
6936	180,000	250,000	33,000	4,13	1	NTN
6936/2595	180,000	259,500	33,000	5,95	1	NTN
6936AZ	180,000	250,000	33,000	4,80	1	NTN
6936AZZ	180,000	250,000	33,000	4,81	1	NTN
6938	190,000	260,000	33,000	4,98	1	NTN
694	4,000	11,000	4,000	0,002	1	NTN
6940	200,000	280,000	38,000	6,07	1	NTN
6940/2795	200,000	279,500	38,000	7,11	1	NTN
6940/2895	200,000	289,500	38,000	8,24	1	NTN
6944	220,000	300,000	38,000	7,69	1	NTN
6944BZZ	220,000	300,000	38,000	7,70	1	NTN
6944LLU	220,000	300,000	38,000	7,69	1	NTN
6948	240,000	320,000	38,000	8,30	1	NTN
6948BLLB	240,000	320,000	38,000	8,58	1	NTN
6948BZZ	240,000	320,000	38,000	8,58	1	NTN
694ZZ	4,000	11,000	4,000	0,002	1	NTN
695	5,000	13,000	4,000	0,002	1	NTN
6952	260,000	360,000	46,000	13,90	1	NTN
6952/3695	260,000	369,500	46,000	16,20	1	NTN
6952D2	260,000	360,000	92,000	27,80	1	NTN
6956	280,000	380,000	46,000	14,40	1	NTN
6956/3895	280,000	389,500	46,000	14,00	1	NTN
6956BLB	280,000	380,000	46,000	12,60	1	NTN
6956BLLU	280,000	380,000	46,000	12,60	1	NTN
695A	5,000	13,000	4,000	0,002	1	NTN
695AZZ	5,000	13,000	4,000	0,002	1	NTN
696	6,000	15,000	5,000	0,004	1	NTN
6960	300,000	420,000	56,000	23,50	1	NTN

Reference	d	D	B	Kg	?	Brands
6960/4195	300,000	419,500	56,000	20,00	1	NTN
6964	320,000	440,000	56,000	25,34	1	NTN
6968	340,000	460,000	56,000	26,20	1	NTN
696LLU	6,000	15,000	5,000	0,004	1	NTN
696ZZ	6,000	15,000	5,000	0,003	1	NTN
696ZZA	6,000	15,000	5,000	0,004	1	NTN
697	7,000	17,000	5,000	0,01	1	NTN
6972	360,000	480,000	56,000	27,70	1	NTN
6972/4795	360,000	479,500	56,000	27,70	1	NTN
6976	380,000	520,000	65,000	39,80	1	NTN
6976/5195	380,000	519,500	65,000	39,80	1	NTN
697LLU	7,000	17,000	5,000	0,01	1	NTN
697Z	7,000	17,000	5,000	0,01	1	NTN
697ZZ	7,000	17,000	5,000	0,01	1	NTN
698	8,000	19,000	6,000	0,01	1	NTN
6980	400,000	540,000	65,000	42,10	1	NTN
6984	420,000	560,000	65,000	43,40	1	NTN
6988	440,000	600,000	74,000	61,20	1	NTN
698LLB	8,000	19,000	6,000	0,01	1	NTN
698LLU	8,000	19,000	6,000	0,01	1	NTN
698ZZ	8,000	19,000	6,000	0,01	1	NTN
698ZZD2	8,000	19,000	12,000	0,01	1	NTN
699	9,000	20,000	6,000	0,01	1	NTN
6992	460,000	620,000	74,000	62,20	1	NTN
6996	480,000	650,000	78,000	73,00	1	NTN
699BZZ	9,000	20,000	6,000	0,01	1	NTN
699Z	9,000	20,000	6,000	0,01	1	NTN
699ZZ	9,000	20,000	6,000	0,01	1	NTN
70/500	500,000	720,000	100,000	129,00	2	NTN
7000	10,000	26,000	8,000	0,02	2	NTN
7000DB	10,000	26,000	16,000	0,04	2	NTN
7000DF	10,000	26,000	16,000	0,04	2	NTN
7001	12,000	28,000	8,000	0,02	2	NTN
7001DB	12,000	28,000	16,000	0,04	2	NTN
7001DF	12,000	28,000	16,000	0,04	2	NTN
7001DT	12,000	28,000	16,000	0,05	2	NTN
7002	15,000	32,000	9,000	0,04	2	NTN
7002DB	15,000	32,000	18,000	0,09	2	NTN
7002DF	15,000	32,000	18,000	0,09	2	NTN
7002DT	15,000	32,000	18,000	0,09	2	NTN
7003	17,000	35,000	10,000	0,04	2	NTN
7003DB	17,000	35,000	20,000	0,09	2	NTN
7003DF	17,000	35,000	20,000	0,09	2	NTN
7003DFT	17,000	35,000	30,000	0,11	2	NTN
7003DT	17,000	35,000	20,000	0,09	2	NTN
7004	20,000	42,000	12,000	0,08	2	NTN
7004DB	20,000	42,000	24,000	0,15	2	NTN
7004DF	20,000	42,000	24,000	0,15	2	NTN
7004DT	20,000	42,000	24,000	0,13	2	NTN



Reference	d	D	B	Kg	?	Brands
7005	25,000	47,000	12,000	0,09	2	NTN
7005DB	25,000	47,000	24,000	0,18	2	NTN
7005DF	25,000	47,000	24,000	0,18	2	NTN
7005DT	25,000	47,000	24,000	0,18	2	NTN
7006	30,000	55,000	13,000	0,14	2	NTN
7006DB	30,000	55,000	26,000	0,26	2	NTN
7006DF	30,000	55,000	26,000	0,26	2	NTN
7006DT	30,000	55,000	26,000	0,26	2	NTN
7007	35,000	62,000	14,000	0,17	2	NTN
7007DB	35,000	62,000	28,000	0,35	2	NTN
7007DF	35,000	62,000	28,000	0,35	2	NTN
7007DT	35,000	62,000	28,000	0,35	2	NTN
7008	40,000	68,000	15,000	0,22	2	NTN
7008DB	40,000	68,000	30,000	0,42	2	NTN
7008DF	40,000	68,000	30,000	0,42	2	NTN
7008DT	40,000	68,000	30,000	0,42	2	NTN
7009	45,000	75,000	16,000	0,27	2	NTN
7009DB	45,000	75,000	32,000	0,54	2	NTN
7010	50,000	80,000	16,000	0,31	2	NTN
7010B	50,000	80,000	16,000	0,30	2	NTN
7010DB	50,000	80,000	32,000	0,60	2	NTN
7010DF	50,000	80,000	32,000	0,58	2	NTN
7011	55,000	90,000	18,000	0,37	2	NTN
7011DB	55,000	90,000	36,000	0,75	2	NTN
7011DF	55,000	90,000	36,000	0,75	2	NTN
7012	60,000	95,000	18,000	0,48	2	NTN
7012DB	60,000	95,000	36,000	0,94	2	NTN
7012DF	60,000	95,000	36,000	0,90	2	NTN
7013	65,000	100,000	18,000	0,43	2	NTN
7013DB	65,000	100,000	36,000	0,97	2	NTN
7013DF	65,000	100,000	36,000	0,88	2	NTN
7014	70,000	110,000	20,000	0,71	2	NTN
7014DB	70,000	110,000	40,000	1,29	2	NTN
7015	75,000	115,000	20,000	0,72	2	NTN
7015DB	75,000	115,000	40,000	1,44	2	NTN
7016	80,000	125,000	22,000	0,99	2	NTN
7016DB	80,000	125,000	44,000	1,86	2	NTN
7017	85,000	130,000	22,000	1,03	2	NTN
7017DB	85,000	130,000	44,000	2,07	2	NTN
7018	90,000	140,000	24,000	1,35	2	NTN
7018B	90,000	140,000	24,000	1,33	2	NTN
7018DB	90,000	140,000	48,000	2,66	2	NTN
7019	95,000	145,000	24,000	1,20	2	NTN
7019BDBT	95,000	145,000	72,000	3,66	2	NTN
7019DB	95,000	145,000	48,000	2,82	2	NTN
7019DF	95,000	145,000	48,000	2,82	2	NTN
7020	100,000	150,000	24,000	1,47	2	NTN

Reference	d	D	B	Kg	?	Brands
7020B	100,000	150,000	24,000	1,49	2	NTN
7020DB	100,000	150,000	48,000	2,86	2	NTN
7021	105,000	160,000	26,000	1,86	2	NTN
7021B	105,000	160,000	26,000	1,88	2	NTN
7021DB	105,000	160,000	52,000	3,72	2	NTN
7022	110,000	170,000	28,000	2,30	2	NTN
7022B	110,000	170,000	28,000	2,34	2	NTN
7022BDBT	110,000	170,000	84,000	5,94	2	NTN
7022DB	110,000	170,000	56,000	4,56	2	NTN
7022DF	110,000	170,000	56,000	4,42	2	NTN
7024	120,000	180,000	28,000	2,36	2	NTN
7024B	120,000	180,000	28,000	2,51	2	NTN
7024DB	120,000	180,000	56,000	4,73	2	NTN
7024DF	120,000	180,000	56,000	4,73	2	NTN
7026	130,000	200,000	33,000	3,73	2	NTN
7026B	130,000	200,000	33,000	3,78	2	NTN
7026BDB	130,000	200,000	66,000	7,38	2	NTN
7026DB	130,000	200,000	66,000	7,14	2	NTN
7028	140,000	210,000	33,000	3,80	2	NTN
7028B	140,000	210,000	33,000	4,01	2	NTN
7028BG	140,000	210,000	33,000	3,96	2	NTN
7028C	140,000	210,000	33,000	3,79	2	NTN
7028CDB	140,000	210,000	66,000	7,58	2	NTN
7028CG	140,000	210,000	33,000	3,79	2	NTN
7028DB	140,000	210,000	33,000	7,92	2	NTN
7028T1DT	140,000	210,000	66,000	7,92	2	NTN
7030	150,000	225,000	35,000	4,82	2	NTN
7030B	150,000	225,000	35,000	4,88	2	NTN
7030C	150,000	225,000	35,000	4,61	2	NTN
7030CDB	150,000	225,000	70,000	9,21	2	NTN
7030CDBT	150,000	225,000	105,000	13,82	2	NTN
7030CDT	150,000	225,000	70,000	9,21	2	NTN
7030CDTBT	150,000	225,000	140,000	18,43	2	NTN
7030CG	150,000	225,000	35,000	4,61	2	NTN
7030DB	150,000	225,000	70,000	9,24	2	NTN
7032	160,000	240,000	38,000	5,66	2	NTN
7032B	160,000	240,000	38,000	5,96	2	NTN
7032BDBT	160,000	240,000	114,000	17,88	2	NTN
7032C	160,000	240,000	38,000	5,65	2	NTN
7032CDB	160,000	240,000	76,000	11,30	2	NTN
7032CDF	160,000	240,000	76,000	11,30	2	NTN
7032CDTBT	160,000	240,000	152,000	23,84	2	NTN
7032CG	160,000	240,000	38,000	5,96	2	NTN
7032DB	160,000	240,000	76,000	10,15	2	NTN
7032DTBT	160,000	240,000	152,000	23,84	2	NTN
7034	170,000	260,000	42,000	7,96	2	NTN
7034B	170,000	260,000	42,000	8,02	2	NTN
7034BDBTT	170,000	260,000	168,000	31,84	2	NTN
7034C	170,000	260,000	42,000	7,62	2	NTN
7034CDB	170,000	260,000	84,000	15,24	2	NTN
7034CDBT	170,000	260,000	126,000	23,88	2	NTN
7034DB	170,000	260,000	84,000	15,00	2	NTN
7036	180,000	280,000	46,000	10,40	2	NTN

Reference	d	D	B	Kg		Brands
7036B	180,000	280,000	46,000	10,50	2	NTN
7036BDBT	180,000	280,000	138,000	31,20	2	NTN
7036DB	180,000	280,000	92,000	20,80	2	NTN
7036DF	180,000	280,000	92,000	20,80	2	NTN
7036G	180,000	280,000	46,000	10,40	2	NTN
7038	190,000	290,000	46,000	10,80	2	NTN
7038B	190,000	290,000	46,000	10,90	2	NTN
7038C	190,000	290,000	46,000	10,40	2	NTN
7038DB	190,000	290,000	46,000	21,60	2	NTN
7040	200,000	310,000	51,000	13,50	2	NTN
7040B	200,000	310,000	51,000	13,86	2	NTN
7040DB	200,000	310,000	102,000	27,00	2	NTN
7044	220,000	340,000	56,000	18,20	2	NTN
7044B	220,000	340,000	56,000	18,40	2	NTN
7044BDF	220,000	340,000	112,000	36,20	2	NTN
7044DF	220,000	340,000	112,000	36,40	2	NTN
7048	240,000	360,000	56,000	19,50	2	NTN
7048B	240,000	360,000	56,000	19,80	2	NTN
7052	260,000	400,000	65,000	28,70	2	NTN
7052B	260,000	400,000	65,000	29,00	2	NTN
7056	280,000	420,000	65,000	30,70	2	NTN
7056B	280,000	420,000	65,000	30,90	2	NTN
7056CDB	280,000	420,000	130,000	61,40	2	NTN
7056DB	280,000	420,000	130,000	61,40	2	NTN
7060	300,000	460,000	74,000	43,40	2	NTN
7060B	300,000	460,000	74,000	43,70	2	NTN
7060CDB	300,000	460,000	148,000	73,50	2	NTN
7060DB	300,000	460,000	148,000	86,80	2	NTN
7064	320,000	480,000	74,000	45,70	2	NTN
7068	340,000	520,000	82,000	61,10	2	NTN
7072	360,000	540,000	82,000	63,40	2	NTN
7076	380,000	560,000	82,000	66,30	2	NTN
7080	400,000	600,000	90,000	86,10	2	NTN
7080DB	400,000	600,000	180,000	85,00	2	NTN
7084	420,000	620,000	90,000	89,70	2	NTN
7088	440,000	650,000	94,000	103,00	2	NTN
7092	460,000	680,000	100,000	119,00	2	NTN
7096	480,000	700,000	100,000	123,00	2	NTN
7200	10,000	30,000	9,000	0,03	2	NTN
7200B	10,000	30,000	9,000	0,03	2	NTN
7200BG	10,000	30,000	9,000	0,03	2	NTN
7200DB	10,000	30,000	18,000	0,06	2	NTN
7200DF	10,000	30,000	18,000	0,06	2	NTN
7201	12,000	32,000	10,000	0,04	2	NTN
7201B	12,000	32,000	10,000	0,04	2	NTN
7201BDB	12,000	32,000	20,000	0,08	2	NTN
7201BG	12,000	32,000	10,000	0,04	2	NTN
7201DB	12,000	32,000	20,000	0,07	2	NTN
7201DT	12,000	32,000	20,000	0,07	2	NTN

Reference	d	D	B	Kg		Brands
7202	15,000	35,000	11,000	0,04	2	NTN
7202B	15,000	35,000	11,000	0,05	2	NTN
7202BA	15,000	35,000	11,000	0,04	2	SNR
7202BDB	15,000	35,000	22,000	0,09	2	NTN
7202BG	15,000	35,000	11,000	0,05	2	NTN
7202DB	15,000	35,000	22,000	0,09	2	NTN
7202DF	15,000	35,000	22,000	0,09	2	NTN
7203	17,000	40,000	12,000	0,06	2	NTN
7203B	17,000	40,000	12,000	0,07	2	NTN-SNR
7203BDB	17,000	40,000	24,000	0,13	2	NTN
7203BDF	17,000	40,000	24,000	0,13	2	NTN
7203BG	17,000	40,000	12,000	0,07	2	NTN
7203BGA	17,000	40,000	12,000	0,07	2	SNR
7203DB	17,000	40,000	24,000	0,13	2	NTN
7203DF	17,000	40,000	24,000	0,13	2	NTN
7203DT	17,000	40,000	24,000	0,13	2	NTN
7204	20,000	47,000	14,000	0,10	2	NTN
7204B	20,000	47,000	14,000	0,11	2	NTN
7204BA	20,000	47,000	14,000	0,11	2	SNR
7204BDB	20,000	47,000	28,000	0,21	2	NTN
7204BDF	20,000	47,000	28,000	0,21	2	NTN
7204BG	20,000	47,000	14,000	0,11	2	NTN
7204BGA	20,000	47,000	14,000	0,11	2	SNR
7204DB	20,000	47,000	28,000	0,21	2	NTN
7204DF	20,000	47,000	28,000	0,21	2	NTN
7204DT	20,000	47,000	28,000	0,21	2	NTN
7205BDB	25,000	52,000	30,000	0,26	2	NTN
7205BDF	25,000	52,000	30,000	0,26	2	NTN
7205BG	25,000	52,000	15,000	0,13	2	NTN
7205BGA	25,000	52,000	15,000	0,13	2	SNR
7205DB	25,000	52,000	30,000	0,25	2	NTN
7205DF	25,000	52,000	30,000	0,25	2	NTN
7205DT	25,000	52,000	30,000	0,25	2	NTN
7206	30,000	62,000	16,000	0,19	2	NTN-SNR
7206B	30,000	62,000	16,000	0,20	2	NTN
7206BDB	30,000	62,000	32,000	0,40	2	NTN
7206BDF	30,000	62,000	32,000	0,40	2	NTN
7206BG	30,000	62,000	16,000	0,20	2	NTN
7206BGA	30,000	62,000	16,000	0,20	2	SNR
7206DB	30,000	62,000	32,000	0,39	2	NTN
7206DF	30,000	62,000	32,000	0,39	2	NTN
7206DT	30,000	62,000	32,000	0,39	2	NTN
7207	35,000	72,000	17,000	0,28	2	NTN-SNR
7207B	35,000	72,000	17,000	0,28	2	NTN
7207BDB	35,000	72,000	34,000	0,58	2	NTN
7207BDF	35,000	72,000	34,000	0,58	2	NTN
7207BG	35,000	72,000	17,000	0,29	2	NTN
7207BGA	35,000	72,000	17,000	0,29	2	SNR
7207DB	35,000	72,000	34,000	0,35	2	NTN
7207DT	35,000	72,000	34,000	0,57	2	NTN
7208	40,000	80,000	18,000	0,36	2	NTN
7208B	40,000	80,000	18,000	0,38	2	NTN
7208BA	40,000	80,000	18,000	0,38	2	SNR
7208BDB	40,000	80,000	36,000	0,75	2	NTN
7208BDF	40,000	80,000	36,000	0,75	2	NTN
7208BDT	40,000	80,000	36,000	0,75	2	NTN



Reference	d	D	B	Kg	?	Brands
7208BG	40,000	80,000	18,000	0,36	2	NTN
7208BGA	40,000	80,000	18,000	0,38	2	SNR
7208BGM	40,000	80,000	18,000	0,42	2	SNR
7208DB	40,000	80,000	36,000	0,71	2	NTN
7208DF	40,000	80,000	36,000	0,74	2	NTN
7208DT	40,000	80,000	36,000	0,71	2	NTN
7209	45,000	85,000	19,000	0,40	2	NTN
7209B	45,000	85,000	19,000	0,41	2	NTN
7209BA	45,000	85,000	19,000	0,42	2	SNR
7209BDB	45,000	85,000	38,000	0,81	2	NTN
7209BDF	45,000	85,000	38,000	0,81	2	NTN
7209BG	45,000	85,000	19,000	0,41	2	NTN
7209BGA	45,000	85,000	19,000	0,42	2	SNR
7209BGM	45,000	85,000	19,000	0,47	2	SNR
7209DB	45,000	85,000	38,000	0,81	2	NTN
7209DF	45,000	85,000	38,000	0,81	2	NTN
7210	50,000	90,000	20,000	0,52	2	NTN-SNR
7210B	50,000	90,000	20,000	0,47	2	NTN
7210BDB	50,000	90,000	40,000	0,93	2	NTN
7210BDF	50,000	90,000	40,000	0,93	2	NTN
7210BDT	50,000	90,000	40,000	0,93	2	NTN
7210BG	50,000	90,000	20,000	0,47	2	NTN
7210BGA	50,000	90,000	20,000	0,44	2	SNR
7210BGM	50,000	90,000	20,000	0,52	2	SNR
7210DB	50,000	90,000	40,000	0,91	2	NTN
7210DF	50,000	90,000	40,000	0,91	2	NTN
7211	55,000	100,000	21,000	0,60	2	NTN
7211B	55,000	100,000	21,000	0,62	2	NTN
7211BA	55,000	100,000	21,000	0,61	2	SNR
7211BDB	55,000	100,000	42,000	1,23	2	NTN
7211BDF	55,000	100,000	42,000	1,23	2	NTN
7211BG	55,000	100,000	21,000	0,62	2	NTN
7211BGA	55,000	100,000	21,000	0,62	2	SNR
7211BGM	55,000	100,000	21,000	0,69	2	SNR
7211DB	55,000	100,000	42,000	1,21	2	NTN
7211DF	55,000	100,000	42,000	1,21	2	NTN
7212	60,000	110,000	22,000	0,78	2	NTN
7212B	60,000	110,000	22,000	0,80	2	NTN
7212BA	60,000	110,000	22,000	0,81	2	SNR
7212BDB	60,000	110,000	44,000	1,59	2	NTN
7212BDF	60,000	110,000	44,000	1,59	2	NTN
7212BG	60,000	110,000	22,000	0,80	2	NTN
7212BGA	60,000	110,000	22,000	0,78	2	SNR
7212BGM	60,000	110,000	22,000	0,23	2	SNR
7212DB	60,000	110,000	44,000	1,56	2	NTN
7212DF	60,000	110,000	44,000	1,56	2	NTN
7213	65,000	120,000	23,000	0,96	2	NTN
7213B	65,000	120,000	23,000	0,97	2	NTN
7213BA	65,000	120,000	23,000	1,03	2	SNR
7213BDB	65,000	120,000	46,000	2,06	2	NTN
7213BDF	65,000	120,000	46,000	2,05	2	NTN
7213BG	65,000	120,000	23,000	1,03	2	NTN
7213BGA	65,000	120,000	23,000	1,03	2	SNR
7213BGM	65,000	120,000	23,000	1,14	2	SNR
7213DB	65,000	120,000	46,000	2,04	2	NTN
7213DF	65,000	120,000	46,000	2,04	2	NTN

Reference	d	D	B	Kg	?	Brands
7214	70,000	125,000	24,000	1,10	2	NTN
7214B	70,000	125,000	24,000	1,11	2	NTN
7214BA	70,000	125,000	24,000	1,11	2	SNR
7214BDB	70,000	125,000	48,000	2,22	2	NTN
7214BG	70,000	125,000	24,000	1,11	2	NTN
7214BGA	70,000	125,000	24,000	1,11	2	SNR
7214BGM	70,000	125,000	24,000	1,23	2	SNR
7214DB	70,000	125,000	48,000	2,20	2	NTN
7214DF	70,000	125,000	48,000	2,20	2	NTN
7214DTBT	70,000	125,000	96,000	4,36	2	NTN
7215	75,000	130,000	25,000	1,17	2	NTN
7215B	75,000	130,000	25,000	1,19	2	NTN
7215BA	75,000	130,000	25,000	1,19	2	SNR
7215BDB	75,000	130,000	50,000	2,40	2	NTN
7215BDBT	75,000	130,000	75,000	3,63	2	NTN
7215BG	75,000	130,000	25,000	1,20	2	NTN
7215BGA	75,000	130,000	25,000	1,19	2	SNR
7215BGM	75,000	130,000	25,000	1,34	2	SNR
7215DB	75,000	130,000	50,000	2,36	2	NTN
7215DF	75,000	130,000	50,000	2,36	2	NTN
7216	80,000	140,000	26,000	1,45	2	NTN
7216B	80,000	140,000	26,000	1,49	2	NTN
7216BDB	80,000	140,000	52,000	2,98	2	NTN
7216BDF	80,000	140,000	52,000	2,86	2	NTN
7216BG	80,000	140,000	26,000	1,49	2	NTN
7216BGM	80,000	140,000	26,000	1,66	2	SNR
7216DB	80,000	140,000	52,000	2,90	2	NTN
7216DF	80,000	140,000	52,000	2,90	2	NTN
7217	85,000	150,000	28,000	1,78	2	NTN
7217B	85,000	150,000	28,000	1,82	2	NTN
7217BDB	85,000	150,000	56,000	3,71	2	NTN
7217BG	85,000	150,000	28,000	1,85	2	NTN
7217BGM	85,000	150,000	28,000	2,05	2	SNR
7217DB	85,000	150,000	56,000	3,64	2	NTN
7217DF	85,000	150,000	56,000	3,56	2	NTN
7218	90,000	160,000	30,000	2,24	2	NTN
7218B	90,000	160,000	30,000	2,22	2	NTN
7218BDB	90,000	160,000	60,000	4,46	2	NTN
7218BDF	90,000	160,000	60,000	4,46	2	NTN
7218BG	90,000	160,000	30,000	2,23	2	NTN
7218BGM	90,000	160,000	30,000	2,52	2	SNR
7218C	90,000	160,000	30,000	2,21	2	NTN
7218DB	90,000	160,000	60,000	4,48	2	NTN
7218DF	90,000	160,000	60,000	4,48	2	NTN
7219	95,000	170,000	32,000	2,67	2	NTN
7219B	95,000	170,000	32,000	2,72	2	NTN
7219BDB	95,000	170,000	64,000	4,48	2	NTN
7219BDF	95,000	170,000	64,000	4,48	2	NTN
7219BG	95,000	170,000	32,000	2,74	2	NTN
7219BGM	95,000	170,000	32,000	3,04	2	SNR
7219DB	95,000	170,000	64,000	5,34	2	NTN
7219DF	95,000	170,000	64,000	5,34	2	NTN
7220	100,000	180,000	34,000	3,20	2	NTN
7220B	100,000	180,000	34,000	3,24	2	NTN
7220BBG	100,000	180,000	34,000	2,97	2	NTN
7220BDB	100,000	180,000	68,000	6,48	2	NTN

Reference	d	D	B	Kg		Brands
7220BG	100,000	180,000	34,000	3,24	2	NTN
7220BGM	100,000	180,000	34,000	3,67	2	SNR
7220DB	100,000	180,000	68,000	6,40	2	NTN
7220DF	100,000	180,000	68,000	6,40	2	NTN
7221	105,000	190,000	36,000	3,79	2	NTN
7221B	105,000	190,000	36,000	3,87	2	NTN
7221BDB	105,000	190,000	72,000	7,74	2	NTN
7221BG	105,000	190,000	36,000	4,35	2	NTN
7221DB	105,000	190,000	72,000	7,75	2	NTN
7221DF	105,000	190,000	72,000	7,78	2	NTN
7222	110,000	200,000	38,000	4,41	2	NTN
7222B	110,000	200,000	38,000	4,54	2	NTN
7222BBG	110,000	200,000	38,000	4,48	2	NTN
7222BDB	110,000	200,000	76,000	9,12	2	NTN
7222BDF	110,000	200,000	76,000	8,82	2	NTN
7222BDFT	110,000	200,000	114,000	15,43	2	NTN
7222BG	110,000	200,000	38,000	4,56	2	NTN
7222BGM	110,000	200,000	38,000	5,07	2	SNR
7222DB	110,000	200,000	76,000	8,98	2	NTN
7222DF	110,000	200,000	76,000	8,98	2	NTN
7224	120,000	215,000	40,000	6,26	2	NTN
7224B	120,000	215,000	40,000	6,21	2	NTN
7224BDB	120,000	215,000	80,000	12,52	2	NTN
7224BDF	120,000	215,000	80,000	12,52	2	NTN
7224BG	120,000	215,000	40,000	6,21	2	NTN
7224BGM	120,000	215,000	40,000	6,10	2	SNR
7224C	120,000	215,000	40,000	5,35	2	NTN
7224CDB	120,000	215,000	80,000	10,70	2	NTN
7224CDTBT	120,000	215,000	160,000	20,64	2	NTN
7224DB	120,000	215,000	80,000	12,02	2	NTN
7224DF	120,000	215,000	80,000	12,02	2	NTN
7226	130,000	230,000	40,000	7,15	2	NTN
7226B	130,000	230,000	40,000	6,95	2	NTN
7226BDF	130,000	230,000	80,000	13,90	2	NTN
7226BG	130,000	230,000	40,000	6,95	2	NTN
7226BGM	130,000	230,000	40,000	6,98	2	SNR
7226C	130,000	230,000	40,000	5,83	2	NTN
7226CDB	130,000	230,000	80,000	11,66	2	NTN
7226DB	130,000	230,000	80,000	14,30	2	NTN
7226DF	130,000	230,000	80,000	13,60	2	NTN
7228	140,000	250,000	42,000	8,78	2	NTN
7228B	140,000	250,000	42,000	8,78	2	NTN
7228BDB	140,000	250,000	84,000	17,56	2	NTN
7228BDF	140,000	250,000	84,000	17,56	2	NTN
7228BG	140,000	250,000	42,000	8,78	2	NTN
7228BGM	140,000	250,000	42,000	8,86	2	SNR
7228C	140,000	250,000	42,000	7,30	2	NTN
7228DB	140,000	250,000	84,000	17,52	2	NTN
7228DF	140,000	250,000	84,000	17,56	2	NTN
7228DFT	140,000	250,000	126,000	26,30	2	NTN
7228DT	140,000	250,000	84,000	17,56	2	NTN
7230	150,000	270,000	45,000	11,20	2	NTN
7230B	150,000	270,000	45,000	11,30	2	NTN
7230BG	150,000	270,000	45,000	11,30	2	NTN
7230BGM	150,000	270,000	45,000	11,40	2	SNR
7230C	150,000	270,000	45,000	11,10	2	NTN

Reference	d	D	B	Kg		Brands
7232	160,000	290,000	48,000	13,70	2	NTN
7232B	160,000	290,000	48,000	14,10	2	NTN
7232BG	160,000	290,000	48,000	14,10	2	NTN
7232BGM	160,000	290,000	48,000	14,09	2	SNR
7232C	160,000	290,000	48,000	13,74	2	NTN
7234	170,000	310,000	52,000	17,00	2	NTN
7234B	170,000	310,000	52,000	18,60	2	NTN
7234BDFT	170,000	310,000	156,000	55,80	2	NTN
7234BG	170,000	310,000	52,000	17,40	2	NTN
7234BGM	170,000	310,000	52,000	17,75	2	SNR
7236	180,000	320,000	52,000	17,70	2	NTN
7236B	180,000	320,000	52,000	17,80	2	NTN
7236BG	180,000	320,000	52,000	17,80	2	NTN
7236DB	180,000	320,000	104,000	35,40	2	NTN
7238	190,000	340,000	55,000	18,20	2	NTN
7238B	190,000	340,000	55,000	22,10	2	NTN
7238BG	190,000	340,000	55,000	22,72	2	NTN
7238C	190,000	340,000	55,000	21,30	2	NTN
7238DF	190,000	340,000	110,000	44,00	2	NTN
7240	202,000	360,000	58,000	25,30	2	NTN
7240B	200,000	360,000	58,000	26,31	2	NTN
7240DB	200,000	360,000	116,000	51,30	2	NTN
7240DF	200,000	360,000	116,000	50,60	2	NTN
7240DT	200,000	360,000	116,000	50,60	2	NTN
7244	220,000	400,000	65,000	37,10	2	NTN
7244B	220,000	400,000	65,000	25,46	2	NTN
7248	240,000	440,000	72,000	49,80	2	NTN
7252	260,000	480,000	80,000	66,00	2	NTN
7252B	260,000	480,000	80,000	45,72	2	NTN
7256	280,000	500,000	80,000	69,70	2	NTN
7256DB	280,000	500,000	160,000	114,00	2	NTN
7260	300,000	540,000	85,000	87,20	2	NTN
7264	320,000	580,000	92,000	109,00	2	NTN
7268	340,000	620,000	92,000	127,00	2	NTN
7272	360,000	650,000	95,000	143,00	2	NTN
72964	320,000	440,000	72,000	30,00	1	NTN
7300	10,000	35,000	11,000	0,05	2	NTN
7300B	10,000	35,000	11,000	0,06	2	NTN
7300BDB	10,000	35,000	22,000	0,11	2	NTN
7300BDF	10,000	35,000	22,000	0,11	2	NTN
7300BG	10,000	35,000	11,000	0,05	2	NTN
7300DB	10,000	35,000	22,000	0,11	2	NTN
7301	12,000	37,000	12,000	0,04	2	NTN
7301B	12,000	37,000	12,000	0,06	2	NTN
7301BDB	12,000	37,000	24,000	0,12	2	NTN
7301BDF	12,000	37,000	24,000	0,12	2	NTN
7302	15,000	42,000	13,000	0,08	2	NTN
7302B	15,000	42,000	13,000	0,09	2	NTN
7302BDB	15,000	42,000	26,000	0,17	2	NTN
7302BDF	15,000	42,000	26,000	0,11	2	NTN
7302BG	15,000	42,000	13,000	0,08	2	NTN
7302DB	15,000	42,000	26,000	0,17	2	NTN



Reference	d	D	B	Kg	?	Brands
7302DF	15,000	42,000	26,000	0,17	2	NTN
7303	17,000	47,000	14,000	0,11	2	NTN
7303B	17,000	47,000	14,000	0,12	2	NTN
7303BDB	17,000	47,000	28,000	0,23	2	NTN
7303BG	17,000	47,000	14,000	0,12	2	NTN
7303DB	17,000	47,000	28,000	0,23	2	NTN
7303DF	17,000	47,000	28,000	0,23	2	NTN
7304	20,000	52,000	15,000	0,14	2	NTN
7304B	20,000	52,000	15,000	0,14	2	NTN-SNR
7304BDB	20,000	52,000	30,000	0,29	2	NTN
7304BDF	20,000	52,000	30,000	0,29	2	NTN
7304BG	20,000	52,000	15,000	0,15	2	NTN
7304BGA	20,000	52,000	15,000	0,15	2	SNR
7304DB	20,000	52,000	30,000	0,29	2	NTN
7304DF	20,000	52,000	30,000	0,28	2	NTN
7305	25,000	62,000	17,000	0,23	2	NTN-SNR
7305B	25,000	62,000	17,000	0,24	2	NTN
7305BDB	25,000	62,000	34,000	0,47	2	NTN
7305BDF	25,000	62,000	34,000	0,47	2	NTN
7305BDT	25,000	62,000	34,000	0,47	2	NTN
7305BG	25,000	62,000	17,000	0,23	2	NTN
7305BGA	25,000	62,000	17,000	0,23	2	SNR
7305DB	25,000	62,000	34,000	0,46	2	NTN
7305DF	25,000	62,000	34,000	0,46	2	NTN
7305DT	25,000	62,000	34,000	0,46	2	NTN
7306	30,000	72,000	19,000	0,39	2	NTN-SNR
7306B	30,000	72,000	19,000	0,35	2	NTN
7306BDB	30,000	72,000	38,000	0,71	2	NTN
7306BDF	30,000	72,000	38,000	0,71	2	NTN
7306BDT	30,000	72,000	38,000	0,71	2	NTN
7306BG	30,000	72,000	19,000	0,36	2	NTN
7306BGA	30,000	72,000	19,000	0,35	2	SNR
7306DB	30,000	72,000	38,000	0,70	2	NTN
7306DF	30,000	72,000	38,000	0,70	2	NTN
7307	35,000	80,000	21,000	0,46	2	NTN
7307B	35,000	80,000	21,000	0,47	2	NTN
7307BA	35,000	80,000	21,000	0,46	2	SNR
7307BDB	35,000	80,000	42,000	0,93	2	NTN
7307BDF	35,000	80,000	42,000	0,93	2	NTN
7307BDT	35,000	80,000	42,000	0,94	2	NTN
7307BG	35,000	80,000	21,000	0,46	2	NTN
7307BGA	35,000	80,000	21,000	0,46	2	SNR
7307DB	35,000	80,000	42,000	0,93	2	NTN
7307DF	35,000	80,000	42,000	0,93	2	NTN
7308	40,000	90,000	23,000	0,69	2	NTN
7308B	40,000	90,000	23,000	0,64	2	NTN
7308BA	40,000	90,000	23,000	0,31	2	SNR
7308BDB	40,000	90,000	46,000	1,28	2	NTN
7308BDF	40,000	90,000	46,000	1,28	2	NTN
7308BG	40,000	90,000	23,000	0,64	2	NTN
7308BGA	40,000	90,000	23,000	0,63	2	SNR
7308BGM	40,000	90,000	23,000	0,69	2	SNR
7308DB	40,000	90,000	23,000	1,39	2	NTN
7308DF	40,000	90,000	46,000	1,28	2	NTN
7309	45,000	100,000	25,000	0,84	2	NTN

Reference	d	D	B	Kg	?	Brands
7309B	45,000	100,000	25,000	0,85	2	NTN
7309BA	45,000	100,000	25,000	0,83	2	SNR
7309BBG	45,000	100,000	25,000	0,82	2	NTN
7309BDB	45,000	100,000	50,000	1,69	2	NTN
7309BDF	45,000	100,000	50,000	1,69	2	NTN
7309BDT	45,000	100,000	50,000	1,69	2	NTN
7309BG	45,000	100,000	25,000	0,85	2	NTN
7309BGA	45,000	100,000	25,000	0,83	2	SNR
7309BGM	45,000	100,000	25,000	0,93	2	SNR
7309DB	45,000	100,000	50,000	1,66	2	NTN
7309DF	45,000	100,000	50,000	1,66	2	NTN
7309DT	45,000	100,000	50,000	1,67	2	NTN
7310	50,000	110,000	27,000	1,08	2	NTN
7310B	50,000	110,000	27,000	1,11	2	NTN
7310BA	50,000	110,000	27,000	1,07	2	SNR
7310BBG	50,000	110,000	27,000	1,08	2	NTN
7310BDB	50,000	110,000	54,000	2,16	2	NTN
7310DBTT	50,000	110,000	108,000	4,44	2	NTN
7310BDF	50,000	110,000	54,000	2,18	2	NTN
7310BDT	50,000	110,000	54,000	1,05	2	NTN
7310BG	50,000	110,000	27,000	1,09	2	NTN
7310BGA	50,000	110,000	27,000	1,08	2	SNR
7310BGM	50,000	110,000	27,000	1,22	2	SNR
7310DB	50,000	110,000	54,000	2,14	2	NTN
7310DF	50,000	110,000	54,000	2,14	2	NTN
7310DT	50,000	110,000	54,000	2,18	2	NTN
7311	55,000	120,000	29,000	1,39	2	NTN
7311B	55,000	120,000	29,000	1,40	2	NTN
7311BA	55,000	120,000	29,000	1,41	2	SNR
7311BDB	55,000	120,000	58,000	2,82	2	NTN
7311DBTT	55,000	120,000	116,000	5,68	2	NTN
7311BDF	55,000	120,000	58,000	2,82	2	NTN
7311BDT	55,000	120,000	58,000	2,82	2	NTN
7311BG	55,000	120,000	29,000	1,41	2	NTN
7311BGA	55,000	120,000	29,000	1,41	2	SNR
7311BGM	55,000	120,000	29,000	1,56	2	SNR
7311DB	55,000	120,000	58,000	2,81	2	NTN
7311DF	55,000	120,000	58,000	2,81	2	NTN
7312	60,000	130,000	31,000	1,72	2	NTN
7312B	60,000	130,000	31,000	1,76	2	NTN
7312BA	60,000	130,000	31,000	1,74	2	SNR
7312BBG	60,000	130,000	31,000	1,72	2	NTN
7312BDB	60,000	130,000	62,000	3,43	2	NTN
7312BDF	60,000	130,000	62,000	3,52	2	NTN
7312BDT	60,000	130,000	62,000	3,52	2	NTN
7312BG	60,000	130,000	31,000	1,76	2	NTN
7312BGA	60,000	130,000	31,000	1,75	2	SNR
7312BGM	60,000	130,000	31,000	1,91	2	SNR
7312DB	60,000	130,000	62,000	3,43	2	NTN
7312DF	60,000	130,000	62,000	3,44	2	NTN
7313	65,000	140,000	33,000	2,11	2	NTN
7313B	65,000	140,000	33,000	2,15	2	NTN
7313BDB	65,000	140,000	66,000	4,09	2	NTN
7313BDF	65,000	140,000	66,000	4,09	2	NTN
7313BG	65,000	140,000	33,000	2,13	2	NTN
7313BGA	65,000	140,000	33,000	2,12	2	SNR
7313BGM	65,000	140,000	33,000	2,40	2	SNR
7313DB	65,000	140,000	66,000	4,20	2	NTN

Reference	d	D	B	Kg		Brands
7313DF	65,000	140,000	66,000	4,20	2	NTN
7314	70,000	150,000	35,000	2,90	2	NTN
7314B	70,000	150,000	35,000	2,57	2	NTN
7314BDB	70,000	150,000	70,000	4,37	2	NTN
7314BDF	70,000	150,000	70,000	4,37	2	NTN
7314BDT	70,000	150,000	70,000	4,37	2	NTN
7314BG	70,000	150,000	35,000	2,56	2	NTN
7314BGA	70,000	150,000	35,000	2,63	2	SNR
7314BGM	70,000	150,000	35,000	2,92	2	SNR
7314DB	70,000	150,000	70,000	5,16	2	NTN
7314DF	70,000	150,000	70,000	5,16	2	NTN
7314DTBT	70,000	150,000	140,000	10,24	2	NTN
7315	75,000	160,000	37,000	3,07	2	NTN
7315B	75,000	160,000	37,000	3,13	2	NTN
7315BBG	75,000	160,000	37,000	3,08	2	NTN
7315BDB	75,000	160,000	74,000	6,24	2	NTN
7315BDF	75,000	160,000	74,000	4,83	2	NTN
7315BG	75,000	160,000	37,000	3,12	2	NTN
7315BGM	75,000	160,000	37,000	3,52	2	SNR
7315DB	75,000	160,000	74,000	6,20	2	NTN
7315DF	75,000	160,000	74,000	6,20	2	NTN
7316	80,000	170,000	39,000	4,12	2	NTN
7316B	80,000	170,000	39,000	3,72	2	NTN
7316BDB	80,000	170,000	78,000	6,46	2	NTN
7316BDF	80,000	170,000	78,000	7,48	2	NTN
7316BG	80,000	170,000	39,000	3,74	2	NTN
7316BGM	80,000	170,000	39,000	4,15	2	SNR
7316DB	80,000	170,000	78,000	7,46	2	NTN
7316DF	80,000	170,000	78,000	7,46	2	NTN
7316G	80,000	170,000	39,000	3,66	2	NTN
7317	85,000	180,000	41,000	4,34	2	NTN
7317B	85,000	180,000	41,000	4,38	2	NTN
7317BDB	85,000	180,000	82,000	8,76	2	NTN
7317BDT	85,000	180,000	82,000	8,76	2	NTN
7317BG	85,000	180,000	41,000	4,38	2	NTN
7317BGM	85,000	180,000	41,000	4,88	2	SNR
7317DB	85,000	180,000	82,000	8,60	2	NTN
7317DF	85,000	180,000	82,000	8,76	2	NTN
7318	90,000	190,000	43,000	5,70	2	NTN
7318B	90,000	190,000	43,000	5,09	2	NTN
7318BDB	90,000	190,000	86,000	10,18	2	NTN
7318DBTBT	90,000	190,000	172,000	20,36	2	NTN
7318BDF	90,000	190,000	86,000	10,20	2	NTN
7318BDT	90,000	190,000	86,000	10,54	2	NTN
7318BDTBT	90,000	190,000	215,000	25,80	2	NTN
7318BG	90,000	190,000	43,000	5,09	2	NTN
7318BGM	90,000	190,000	43,000	5,68	2	SNR
7318DB	90,000	190,000	86,000	10,02	2	NTN
7318DF	90,000	190,000	86,000	10,00	2	NTN
7319	95,000	200,000	45,000	5,89	2	NTN
7319B	95,000	200,000	45,000	6,00	2	NTN
7319BDB	95,000	200,000	90,000	11,84	2	NTN
7319BG	95,000	200,000	45,000	5,80	2	NTN
7319BGM	95,000	200,000	45,000	6,24	2	SNR
7319DB	95,000	200,000	90,000	11,60	2	NTN
7320	100,000	215,000	47,000	8,10	2	NTN

Reference	d	D	B	Kg		Brands
7320B	100,000	215,000	47,000	7,34	2	NTN
7320BBG	100,000	215,000	47,000	7,32	2	NTN
7320BDB	100,000	215,000	94,000	14,68	2	NTN
7320BDBT	100,000	215,000	141,000	21,96	2	NTN
7320BG	100,000	215,000	47,000	7,34	2	NTN
7320BGM	100,000	215,000	47,000	8,19	2	SNR
7320C	100,000	215,000	47,000	6,90	2	NTN
7320CDB	100,000	215,000	94,000	13,80	2	NTN
7320DB	100,000	215,000	94,000	14,36	2	NTN
7320DF	100,000	215,000	94,000	14,36	2	NTN
7320DT	100,000	215,000	94,000	14,20	2	NTN
7321	105,000	225,000	49,000	8,20	2	NTN
7321B	105,000	225,000	49,000	8,36	2	NTN
7321BDB	105,000	225,000	98,000	16,72	2	NTN
7321BG	105,000	225,000	49,000	8,08	2	NTN
7321BGM	105,000	225,000	49,000	9,34	2	SNR
7321DB	105,000	225,000	98,000	16,42	2	NTN
7322	110,000	240,000	50,000	9,47	2	NTN
7322B	110,000	240,000	50,000	9,95	2	NTN
7322BBG	110,000	240,000	50,000	11,20	2	NTN
7322BDB	110,000	240,000	100,000	19,60	2	NTN
7322BDT	110,000	240,000	100,000	22,00	2	NTN
7322BG	110,000	240,000	50,000	9,95	2	NTN
7322BGM	110,000	240,000	50,000	11,22	2	SNR
7322C	110,000	240,000	50,000	9,59	2	NTN
7322CDB	110,000	240,000	100,000	19,18	2	NTN
7322DB	110,000	240,000	100,000	10,75	2	NTN
7322DF	110,000	240,000	100,000	21,40	2	NTN
7324	120,000	260,000	55,000	14,70	2	NTN
7324B	120,000	260,000	55,000	13,00	2	NTN
7324BDB	120,000	260,000	110,000	29,00	2	NTN
7324BDT	120,000	260,000	110,000	29,00	2	NTN
7324BG	120,000	260,000	55,000	14,50	2	NTN
7324BGM	120,000	260,000	55,000	14,20	2	SNR
7324DB	120,000	260,000	110,000	28,20	2	NTN
7326	130,000	280,000	58,000	17,70	2	NTN
7326B	130,000	280,000	58,000	17,60	2	NTN
7326BDB	130,000	280,000	116,000	35,20	2	NTN
7326BDF	130,000	280,000	116,000	35,10	2	NTN
7326BDT	130,000	280,000	116,000	35,20	2	NTN
7326BG	130,000	280,000	58,000	17,70	2	NTN
7326BGM	130,000	280,000	58,000	17,53	2	SNR
7326DB	130,000	280,000	116,000	34,00	2	NTN
7328	140,000	300,000	62,000	21,50	2	NTN
7328B	140,000	300,000	62,000	21,50	2	NTN
7328BDB	140,000	300,000	124,000	43,00	2	NTN
7328BG	140,000	300,000	62,000	21,60	2	NTN
7328BGM	140,000	300,000	62,000	21,42	2	SNR
7330	150,000	320,000	65,000	25,10	2	NTN
7330B	150,000	320,000	65,000	25,80	2	NTN
7330BDB	150,000	320,000	130,000	51,20	2	NTN
7330BG	150,000	320,000	65,000	25,70	2	NTN
7330BGM	150,000	320,000	65,000	25,60	2	SNR
7330DB	150,000	320,000	130,000	50,30	2	NTN
7332	160,000	340,000	68,000	29,80	2	NTN



Reference	d	D	B	Kg		Brands
7332B	160,000	340,000	68,000	30,40	2	NTN
7332BG	160,000	340,000	68,000	30,40	2	NTN
7332BGM	160,000	340,000	68,000	30,30	2	SNR
7334	170,000	360,000	72,000	35,80	2	NTN
7334B	170,000	360,000	72,000	35,89	2	NTN
7334BG	170,000	360,000	72,000	36,00	2	NTN
7334BGM	170,000	360,000	72,000	35,80	2	SNR
7334DB	170,000	360,000	144,000	71,60	2	NTN
7336	180,000	380,000	75,000	40,90	2	NTN
7336B	180,000	380,000	75,000	41,80	2	NTN
7338	190,000	400,000	78,000	47,00	2	NTN
7338B	190,000	400,000	78,000	47,00	2	NTN
7338BG	190,000	400,000	78,000	47,00	2	NTN
7340	204,000	420,000	80,000	53,10	2	NTN
7340B	200,000	420,000	80,000	54,20	2	NTN
7344	220,000	460,000	88,000	72,40	2	NTN
7348	240,000	500,000	95,000	92,20	2	NTN
7348BG	240,000	500,000	95,000	93,00	2	NTN
7352	260,000	540,000	102,000	115,00	2	NTN
7356	280,000	580,000	108,000	140,00	2	NTN
7406BG	30,000	90,000	23,000	0,82	2	NTN
7407	35,000	100,000	25,000	1,10	2	NTN
7407B	35,000	100,000	25,000	1,10	2	NTN
7407BG	35,000	100,000	25,000	1,10	2	NTN
7408	40,000	110,000	27,000	1,35	2	NTN
7408B	40,000	110,000	27,000	1,39	2	NTN
7408BDB	40,000	110,000	54,000	2,78	2	NTN
7408BG	40,000	110,000	27,000	1,39	2	NTN
7409	45,000	120,000	29,000	1,73	2	NTN
7409B	45,000	120,000	29,000	1,49	2	NTN
7409BDB	45,000	120,000	58,000	3,57	2	NTN
7409BG	45,000	120,000	29,000	1,77	2	NTN
7410	50,000	130,000	31,000	2,12	2	NTN
7410B	50,000	130,000	31,000	1,86	2	NTN
7410BDB	50,000	130,000	62,000	3,72	2	NTN
7410BG	50,000	130,000	31,000	1,86	2	NTN
7411	55,000	140,000	33,000	2,62	2	NTN
7411B	55,000	140,000	33,000	2,69	2	NTN
7411BDB	55,000	140,000	66,000	5,38	2	NTN
7411BG	55,000	140,000	33,000	2,69	2	NTN
7412	60,000	150,000	35,000	2,75	2	NTN
7412B	60,000	150,000	35,000	2,75	2	NTN
7412BG	60,000	150,000	35,000	3,27	2	NTN
7413	65,000	160,000	37,000	3,29	2	NTN
7413B	65,000	160,000	37,000	3,29	2	NTN
7413BG	65,000	160,000	37,000	3,29	2	NTN

Reference	d	D	B	Kg		Brands
7414	70,000	180,000	42,000	4,81	2	NTN
7414B	70,000	180,000	42,000	4,81	2	NTN
7414BG	70,000	180,000	42,000	5,70	2	NTN
7414DB	70,000	180,000	84,000	9,62	2	NTN
7415BG	75,000	190,000	45,000	5,71	2	NTN
7416	80,000	200,000	48,000	6,71	2	NTN
7416B	80,000	200,000	48,000	6,71	2	NTN
7416BG	80,000	200,000	48,000	6,71	2	NTN
7417BG	85,000	210,000	52,000	7,98	2	NTN
7418BG	90,000	225,000	54,000	9,56	2	NTN
742028	140,000	210,000	69,000	7,04	35	NTN
742030	150,000	225,000	75,000	8,78	35	NTN
742032	160,000	240,000	80,000	10,42	35	NTN
742036	180,000	280,000	100,000	18,50	35	NTN
78/1060	1 060,000	1 280,000	100,000	249,50	2	NTN
78/500	500,000	620,000	56,000	36,50	2	NTN
78/630A	630,000	780,000	69,000	72,20	2	NTN
78/670	670,000	820,000	69,000	76,30	2	NTN
78/670B	670,000	820,000	69,000	76,30	2	NTN
78/670BDB	670,000	820,000	138,000	152,60	2	NTN
7820	100,000	125,000	13,000	0,36	2	NTN
7821	105,000	130,000	13,000	0,37	2	NTN
7822	110,000	140,000	16,000	0,58	2	NTN
7824	120,000	150,000	16,000	0,63	2	NTN
7826	130,000	165,000	18,000	0,91	2	NTN
7828	140,000	175,000	18,000	0,97	2	NTN
7830	150,000	190,000	20,000	1,35	2	NTN
7832	160,000	200,000	20,000	1,42	2	NTN
7834	170,000	215,000	22,000	1,88	2	NTN
7836	180,000	225,000	22,000	1,98	2	NTN
7838	190,000	240,000	24,000	2,55	2	NTN
7840	200,000	250,000	24,000	2,70	2	NTN
7844	220,000	270,000	24,000	2,91	2	NTN
7848	240,000	300,000	28,000	4,49	2	NTN
7848DB	240,000	300,000	56,000	8,56	2	NTN
7852	260,000	320,000	28,000	4,83	2	NTN
7856	280,000	350,000	33,000	7,17	2	NTN
7860	300,000	380,000	38,000	10,10	2	NTN
7864	320,000	400,000	38,000	10,70	2	NTN
7868	340,000	420,000	38,000	11,30	2	NTN
7872	360,000	440,000	38,000	11,90	2	NTN
7876	380,000	480,000	46,000	19,50	2	NTN
7880	400,000	500,000	46,000	20,40	2	NTN
7884	420,000	520,000	46,000	21,10	2	NTN
7888	440,000	540,000	46,000	22,00	2	NTN
7892	460,000	580,000	56,000	33,50	2	NTN
7896	480,000	600,000	56,000	34,90	2	NTN
79/500	500,000	670,000	78,000	74,90	2	NTN
79/560	560,000	750,000	85,000	105,00	2	NTN
7905	25,000	42,000	9,000	0,05	2	NTN

Reference	d	D	B	Kg	?	Brands
7906	30,000	47,000	9,000	0,06	2	NTN
7906DB	30,000	47,000	18,000	0,10	2	NTN
7907	35,000	55,000	10,000	0,09	2	NTN
7908	40,000	62,000	12,000	0,13	2	NTN
7909	45,000	68,000	12,000	0,15	2	NTN
7910	50,000	72,000	12,000	0,13	2	NTN
7910DB	50,000	72,000	24,000	0,29	2	NTN
7911	55,000	80,000	13,000	0,21	2	NTN
7912	60,000	85,000	13,000	0,23	2	NTN
7913	65,000	90,000	13,000	0,25	2	NTN
7914	70,000	100,000	16,000	0,40	2	NTN
7914DB	70,000	100,000	32,000	0,64	2	NTN
7915	75,000	105,000	16,000	0,42	2	NTN
7916	80,000	110,000	16,000	0,44	2	NTN
7916DB	80,000	110,000	32,000	0,89	2	NTN
7917	85,000	120,000	18,000	0,63	2	NTN
7918	90,000	125,000	18,000	0,66	2	NTN
7919	95,000	130,000	18,000	0,58	2	NTN
7920	100,000	140,000	20,000	0,93	2	NTN
7920CDF	100,000	140,000	40,000	1,87	2	NTN
7920DB	100,000	140,000	40,000	1,87	2	NTN
7921	105,000	145,000	20,000	0,97	2	NTN
7922	110,000	150,000	20,000	1,01	2	NTN
7924	120,000	165,000	22,000	1,19	2	NTN
7924DB	120,000	165,000	44,000	2,69	2	NTN
7926	130,000	180,000	24,000	1,82	2	NTN
7928	140,000	190,000	24,000	1,94	2	NTN
7930	150,000	210,000	28,000	2,96	2	NTN
7930C	150,000	210,000	28,000	2,84	2	NTN
7930CDB	150,000	210,000	56,000	5,40	2	NTN
7930CG	150,000	210,000	28,000	2,70	2	NTN
7930DB	150,000	210,000	56,000	5,69	2	NTN
7932	160,000	220,000	28,000	3,13	2	NTN
7932CBG	160,000	220,000	28,000	2,80	2	NTN
7934	170,000	230,000	28,000	3,29	2	NTN
7934CDB	170,000	230,000	56,000	6,49	2	NTN
7934CDTBT	170,000	230,000	112,000	13,00	2	NTN
7934DF	170,000	230,000	56,000	6,70	2	NTN
7936	180,000	250,000	33,000	4,87	2	NTN
7936DB	180,000	250,000	66,000	9,74	2	NTN
7938	190,000	260,000	33,000	5,10	2	NTN
7938BDB	190,000	260,000	66,000	10,20	2	NTN
7940	200,000	280,000	38,000	7,15	2	NTN
7940B/279.5DB	200,000	279,500	76,000	13,90	2	NTN
7940BDF	200,000	280,000	76,000	14,00	2	NTN
7940DB	200,000	280,000	76,000	14,00	2	NTN

Reference	d	D	B	Kg	?	Brands
7944	220,000	300,000	38,000	7,74	2	NTN
7944DB	220,000	300,000	76,000	19,00	2	NTN
7948	240,000	320,000	38,000	8,34	2	NTN
7952	260,000	360,000	46,000	14,00	2	NTN
7952DB	260,000	360,000	92,000	28,00	2	NTN
7952DF	260,000	360,000	92,000	28,00	2	NTN
7956	280,000	380,000	46,000	14,80	2	NTN
7956DB	280,000	380,000	92,000	35,00	2	NTN
7960	300,000	420,000	56,000	23,70	2	NTN
7960/419.5DF	300,000	419,500	112,000	45,70	2	NTN
7964	320,000	440,000	56,000	24,70	2	NTN
7968	340,000	460,000	56,000	26,00	2	NTN
7968BDB	340,000	460,000	112,000	51,27	2	NTN
79724	360,000	480,000	56,000	27,30	2	NTN
7976	380,000	520,000	65,000	39,60	2	NTN
7976DB	380,000	520,000	130,000	79,20	2	NTN
7980	400,000	540,000	65,000	41,00	2	NTN
7984	420,000	560,000	65,000	42,80	2	NTN
7988	440,000	600,000	74,000	59,30	2	NTN
7992	460,000	620,000	74,000	61,60	2	NTN
7996	480,000	650,000	78,000	71,80	2	NTN
8502	15,000	35,000	12,700	0,04	1	NTN
8503	17,000	40,000	14,288	0,08	1	NTN
8505	25,000	52,000	15,875	0,13	1	NTN
8506	30,000	62,000	20,000	0,25	1	NTN
8507	35,000	72,000	21,000	0,29	1	NTN
87008	8,000	24,000	10,319	0,02	1	NTN
87013	13,000	32,000	12,700	0,04	1	NTN
87016	16,000	35,000	12,700	0,04	1	NTN
87500	10,000	30,000	12,700	0,03	1	NTN
87501	12,000	32,000	12,700	0,05	1	NTN
87502	15,000	35,000	12,700	0,05	1	NTN
87503	17,000	40,000	14,288	0,07	1	NTN
87505	25,000	52,000	15,875	0,18	1	NTN
87506	30,000	62,000	20,000	0,25	1	NTN
87507	35,000	72,000	21,000	0,34	1	NTN
88016	16,000	35,000	14,399	0,04	1	NTN
88026	26,000	52,000	16,749	0,13	1	NTN
88500	10,000	30,000	16,401	0,05	1	NTN
88501	12,000	32,000	15,400	0,04	1	NTN
88502	15,000	35,000	14,400	0,05	1	NTN
88503	17,000	40,000	16,601	0,07	1	NTN
88504	20,000	47,000	17,750	0,11	1	NTN
88506	30,000	62,000	24,000	0,21	1	NTN
88506/32	32,000	62,000	24,000	0,24	1	NTN
88507	35,000	72,000	25,000	0,33	1	NTN



Reference	d	D	B	Kg	Brands
88508	40,000	80,000	27,000	0,47	1 NTN
88509	45,000	85,000	27,000	0,49	1 NTN
88510	50,000	90,000	30,000	0,56	1 NTN
88604	20,000	52,000	23,000	0,22	1 NTN
A-2J-DF07A51LA1X-GLRA1-GCS38PX1/L453	35,000	62,000	25,500	0,292	5 NTN
A-2J-DF07A51LA1X-GLRA1-N1CS38PX1/LX16Q1	35,000	62,000	25,500	0,292	5 NTN
A-2J-DF07A68LA1-GLRAXC-S46PX1/LX16Q1	35,000	72,000	33,500	0,571	5 NTN
AEL201D1	12,000	40,000	28,6 / 19	0,12	11 NTN
AEL202D1	15,000	40,000	28,6 / 19	0,11	11 NTN
AEL203D1	17,000	40,000	28,6 / 19	0,10	11 NTN
AEL204D1	20,000	47,000	31 / 21,5	0,17	11 NTN
AEL205D1	25,000	52,000	31 / 21,5	0,20	11 NTN
AEL206D1	30,000	62,000	35,7 / 23,8	0,31	11 NTN
AEL207D1	35,000	72,000	38,9 / 25,4	0,49	11 NTN
AEL208D1	40,000	80,000	43,7 / 30,2	0,66	11 NTN
AELS201N	12,000	40,000	28,6 / 19	0,12	16 NTN
AELS202N	15,000	40,000	28,6 / 19	0,11	16 NTN
AELS203N	17,000	40,000	28,6 / 19	0,10	16 NTN
AELS204N	20,000	47,000	31 / 21,5	0,17	16 NTN
AELS205N	25,000	52,000	31 / 21,5	0,20	16 NTN
AELS206N	30,000	62,000	35,7 / 23,8	0,31	16 NTN
AELS207N	35,000	72,000	38,9 / 25,4	0,49	16 NTN
AELS208N	40,000	80,000	43,7 / 30,2	0,66	16 NTN
AELS210N	50,000	90,000	43,7 / 30,2	0,74	16 NTN
AS201D1	12,000	40,000	22 / 12	0,10	10 NTN
AS202D1	15,000	40,000	22 / 12	0,09	10 NTN
AS203D1	17,000	40,000	22 / 12	0,08	10 NTN
AS204D1	20,000	47,000	25 / 14	0,13	10 NTN
AS205D1	25,000	52,000	27 / 15	0,16	10 NTN
AS206D1	30,000	62,000	29 / 16	0,25	10 NTN
AS207D1	35,000	72,000	34 / 17	0,37	10 NTN
AS208D1	40,000	80,000	38 / 18	0,50	10 NTN
ASS201N	12,000	40,000	22 / 12	0,12	15 NTN
ASS202N	15,000	40,000	22 / 12	0,11	15 NTN
ASS203N	17,000	40,000	22 / 12	0,10	15 NTN
ASS204N	20,000	47,000	25 / 14	0,17	15 NTN
ASS205N	25,000	52,000	27 / 15	0,20	15 NTN
ASS206N	30,000	62,000	29 / 16	0,31	15 NTN
ASS207N	35,000	72,000	34 / 17	0,49	15 NTN
ASS208N	40,000	80,000	38 / 18	0,50	15 NTN
BC2-5	2,000	5,000	2,000	0,16	1 NTN
BC25-8	2,500	8,000	2,500	0,57	1 NTN
BC2-6	2,000	6,000	2,500	0,32	1 NTN
BC2-7A	2,000	7,000	2,500	0,44	1 NTN
BC3-8	3,000	8,000	2,500	0,52	1 NTN
BC3-9	3,000	9,000	2,500	0,71	1 NTN
BC4-10	4,000	10,000	3,000	1,00	1 NTN
BC4-8	4,000	8,000	2,000	0,38	1 NTN
BC5-10	5,000	10,000	3,000	0,88	1 NTN
BC5-9	5,000	9,000	2,500	0,55	1 NTN
BC6-12	6,000	12,000	3,000	1,30	1 NTN
BC6-16A	6,000	16,000	6,000	0,01	1 NTN

Reference	d	D	B	Kg	Brands
BC6-16AZZ	6,000	16,000	6,000	0,01	1 NTN
BC7-13	7,000	13,000	3,000	1,40	1 NTN
BC8-14	8,000	14,000	3,500	1,80	1 NTN
CES204	20,000	47,000	31 / 21,5	0,15	16 SNR
CES205	25,000	52,000	31 / 21,5	0,19	16 SNR
CES206	30,000	62,000	35,7 / 23,8	0,33	16 SNR
CES207	35,000	72,000	38,9 / 25,4	0,50	16 SNR
CES208	40,000	80,000	43,7 / 30,2	0,65	16 SNR
CES209	45,000	85,000	43,7 / 30,2	0,69	16 SNR
CES210	50,000	90,000	43,7 / 30,2	0,80	16 SNR
CEX204	20,000	47,000	43,7 / 34,2	0,22	14 SNR
CEX205	25,000	52,000	44,4 / 34,9	0,25	14 SNR
CEX206	30,000	62,000	48,4 / 36,5	0,41	14 SNR
CEX207	35,000	72,000	51,1 / 37,6	0,60	14 SNR
CEX208	40,000	80,000	56,3 / 42,8	0,78	14 SNR
CEX209	45,000	85,000	56,3 / 42,8	0,87	14 SNR
CEX210	50,000	90,000	62,7 / 49,2	1,01	14 SNR
CS200LLU	10,000	30,000	9,000	0,03	12 NTN
CS201LLU	12,000	32,000	10,000	0,04	12 NTN
CS202LLU	15,000	35,000	11,000	0,04	12 NTN
CS203(6203SEE)	17,000	40,000	12,000	0,06	12 SNR
CS203LLU	17,000	40,000	12,000	0,06	12 NTN
CS204(6204SEE)	20,000	47,000	14,000	0,10	12 SNR
CS204LLU	20,000	47,000	14,000	0,10	12 NTN
CS205(6205SEE)	25,000	52,000	15,000	0,13	12 SNR
CS205LLU	25,000	52,000	15,000	0,13	12 NTN
CS206(6206SEE)	30,000	62,000	16,000	0,20	12 SNR
CS206LLU	30,000	62,000	16,000	0,20	12 NTN
CS207(6207SEE)	35,000	72,000	17,000	0,29	12 SNR
CS207LLU	35,000	72,000	17,000	0,29	12 NTN
CS208(6208SEE)	40,000	80,000	18,000	0,37	12 SNR
CS208LLU	40,000	80,000	18,000	0,37	12 NTN
CS209(6209SEE)	45,000	85,000	19,000	0,40	12 SNR
CS209LLU	45,000	85,000	19,000	0,40	12 NTN
CS210(6210SEE)	50,000	90,000	20,000	0,47	12 SNR
CS210LLU	50,000	90,000	20,000	0,47	12 NTN
CS212(6212SEE)	60,000	110,000	22,000	0,78	12 SNR
CS212LLU	60,000	110,000	22,000	0,78	12 NTN
CS213LLU	65,000	120,000	23,000	0,97	12 NTN
CS305LLU	25,000	62,000	17,000	0,22	12 NTN
CS306LLU	30,000	72,000	19,000	0,34	12 NTN
CS307LLU	35,000	80,000	21,000	0,49	12 NTN
CS308(6308SEE)	40,000	90,000	23,000	0,62	12 SNR
CS308LLU	40,000	90,000	23,000	0,62	12 NTN
CS309(6309SEE)	45,000	100,000	25,000	0,80	12 SNR
CS309LLU	45,000	100,000	25,000	0,80	12 NTN
CS310LLU	50,000	110,000	27,000	1,06	12 NTN
CUC204	20,000	47,000	31 / 17	0,20	13 SNR

Reference	d	D	B	Kg	Brands
CUC205	25,000	52,000	34 / 17	0,21	13 SNR
CUC206	30,000	62,000	38,1 / 19	0,35	13 SNR
CUC207	35,000	72,000	42,9 / 20	0,47	13 SNR
CUC208	40,000	80,000	49,2 / 21	0,64	13 SNR
CUC209	45,000	85,000	49,2 / 22	0,68	13 SNR
CUC210	50,000	90,000	51,6 / 23	0,80	13 SNR
CUS204	20,000	47,000	25 / 14	0,13	15 SNR
CUS205	25,000	52,000	27 / 15	0,17	15 SNR
CUS206	30,000	62,000	30 / 16	0,27	15 SNR
CUS207	35,000	72,000	32 / 17	0,42	15 SNR
CUS208	40,000	80,000	34 / 18	0,48	15 SNR
CUS209	45,000	85,000	41,2 / 19	0,57	15 SNR
CUS210	50,000	90,000	43,5 / 20	0,66	15 SNR
DE2010	100,000	170,000	60,300	5,64	5 NTN
DE2208	110,000	169,500	56,000	4,61	5 NTN
DE2405	120,000	190,000	66,000	7,09	5 NTN
DE2409	120,000	190,000	66,000	7,09	5 NTN
DE2601	130,000	200,000	66,000	7,54	5 NTN
DE2806	140,000	210,000	66,000	7,76	5 NTN
DE2807	140,000	210,000	66,000	7,72	5 NTN
DE2812	140,000	210,000	66,000	8,00	5 NTN
DE3007	150,000	230,000	70,000	9,74	5 NTN
DE3009	150,000	225,000	73,000	9,69	5 NTN
DE3010	150,000	225,000	70,000	9,74	5 NTN
DE3011	150,000	225,000	70,000	9,74	5 NTN
DE3019	150,000	230,000	70,000	9,74	5 NTN
DE3201	160,000	240,000	76,000	12,00	5 NTN
DE3207	160,000	215,000	56,000	5,71	5 NTN
DE3402	170,000	260,000	84,000	16,10	5 NTN
DE3501	175,000	280,000	92,000	21,70	5 NTN
DE3502	175,000	280,000	92,000	21,70	5 NTN
DE3601	180,000	259,500	66,000	10,40	5 NTN
DE3603	180,000	259,500	66,000	10,70	5 NTN
DE3605	180,000	280,000	92,000	20,90	5 NTN
DE3606	180,000	250,000	66,000	9,83	5 NTN
DE3608	180,000	259,500	66,000	10,70	5 NTN
DE3609	180,000	250,000	70,000	10,40	5 NTN
DE3610	180,000	259,500	66,000	10,40	5 NTN
DE3612	180,000	259,500	66,000	10,40	5 NTN
DE3615	180,000	259,500	66,000	10,70	5 NTN
DE3801	190,000	269,500	66,000	11,90	5 NTN
DE3807	190,000	269,500	66,000	11,90	5 NTN
DE4002	200,000	289,500	76,000	16,40	5 NTN
DE4004	200,000	279,500	76,000	14,30	5 NTN
DE4007	200,000	310,000	102,000	28,30	5 NTN
DE4008	200,000	279,500	76,000	14,30	5 NTN
DE4009	200,000	289,500	76,000	16,40	5 NTN
DE4010	200,000	289,500	76,000	16,50	5 NTN
DE4012	200,000	289,500	76,000	16,40	5 NTN
DE4019	200,000	289,500	76,000	16,40	5 NTN
DE4403	220,000	309,500	76,000	17,80	5 NTN
DE4404	220,000	309,500	76,000	17,80	5 NTN

Reference	d	D	B	Kg	Brands
DE4406	220,000	319,500	92,000	24,40	5 NTN
DE4408	220,000	309,500	76,000	17,80	5 NTN
DE4409	220,000	319,500	92,000	24,40	5 NTN
DE4602	230,000	329,500	80,000	22,00	5 NTN
DE4603	230,000	329,500	80,000	22,00	5 NTN
DE4605	230,000	329,500	80,000	22,00	5 NTN
DE4803	240,000	359,500	112,000	39,70	5 NTN
DE5004	250,000	340,000	76,000	18,40	5 NTN
DE5211	260,000	369,500	92,000	31,30	5 NTN
DE5212	260,000	369,500	92,000	30,90	5 NTN
DE5213	260,000	369,500	92,000	31,30	5 NTN
DE5605	280,000	389,500	92,000	33,40	5 NTN
DE6001	300,000	429,500	112,000	52,40	5 NTN
DE7201	360,000	540,000	164,000	131,00	5 NTN
DF0109LLPX1/L627U0JD	12,700	38,200	15,900	0,097	5 NTN
DF0109LLPX1/L657	12,700	38,200	15,900	0,097	5 NTN
DF0109LLPX1/L738	12,700	38,200	15,900	0,097	5 NTN
DF0213LLU/2AS	15,000	35,000	20,000	0,083	5 NTN
DF0213LLU/L623	15,000	35,000	20,000	0,083	5 NTN
DF0213LLUA/LX03Q3	15,000	35,000	20,000	0,086	5 NTN
DF0261C3/2AS	15,000	32,000	15,900	0,054	5 NTN
DF0282LLH1CS23/L417	15,000	42,000	24,000	0,150	5 NTN
DF0484NX	22,000	48,000	20,600	0,166	5 NTN
DF0526NC3	25,000	52,000	20,600	0,172	5 NTN
DF0526NR	25,000	52,000	20,600	0,176	5 NTN
DF0526NRC3	25,000	52,000	20,600	0,177	5 NTN
DF0596N	23,000	57,000	25,400	0,285	5 NTN
DF0617LLUCS25/L417	30,000	55,000	23,017	0,209	5 NTN
DF0617LLU-N1/L417	30,000	55,000	23,017	0,205	5 NTN
DF0654LLUC4/5C	30,000	55,000	23,017	0,207	5 NTN
DF0679PX1	28,000	54,000	20,600	0,173	5 NTN
DF0680NV1	30,000	72,000	24,500	0,475	5 NTN
DF0693NV1	30,000	68,000	25,000	0,402	5 NTN
DF06A51	30,000	58,000	21,500	0,224	5 NTN
DF0766LLUACS32/5C	35,000	64,000	37,000	0,432	5 NTN
DF0766LLUACS32/L283	35,000	64,000	37,000	0,432	5 NTN
DF0768LLU/2AS	35,000	55,000	20,000	0,149	5 NTN
DF07A36	35,000	72,000	28,000	0,469	5 NTN
DF07A52LAX4-BLRA-BCS38PX1/L453	35,000	62,000	25,500	0,293	5 NTN
DF07A74CS16	35,000	72,000	21,000	0,417	5 NTN
DF0961CS15+TKZ0552	45,000	100,000	39,700	1,503	5 NTN
DF1024LLBCS27/L417	50,000	78,000	28,000	0,379	5 NTN
DF1024LLUACS35/L453	50,000	78,000	28,000	0,378	5 NTN
DF1411LLCS32PX1V1	70,000	95,000	40,000	0,670	5 NTN
EC-DF1160LUALACS40PX1/L325	55,000	90,000	40,000	0,762	5 NTN
ES201G2	12,000	40,000	28,6 / 19,1	0,14	11 SNR
ES202G2	15,000	40,000	28,6 / 19,1	0,13	11 SNR
ES203G2	17,000	40,000	28,6 / 19,1	0,13	11 SNR
ES204G2	20,000	47,000	30,9 / 21,4	0,15	11 SNR
ES205G2	25,000	52,000	30,9 / 21,4	0,19	11 SNR



Reference	d	D	B	Kg	Brands
ES206G2	30,000	62,000	35,7 / 23,8	0,33	11 SNR
ES207G2	35,000	72,000	38,9 / 25,4	0,50	11 SNR
ES208G2	40,000	80,000	43,7 / 30,2	0,65	11 SNR
ES209G2	45,000	85,000	43,7 / 30,2	0,69	11 SNR
ES210G2	50,000	90,000	43,7 / 30,2	0,80	11 SNR
ES211G2	55,000	100,000	48,4 / 32,5	0,87	11 SNR
ES212G2	60,000	110,000	49,3 / 33,4	1,20	11 SNR
EX201G2	12,000	47,000	43,5 / 34	0,29	8 SNR
EX202G2	15,000	47,000	43,5 / 34	0,27	8 SNR
EX203G2	17,000	47,000	43,5 / 34	0,25	8 SNR
EX204G2	20,000	47,000	43,5 / 34	0,22	8 SNR
EX205G2	25,000	52,000	44,3 / 34,8	0,25	8 SNR
EX206G2	30,000	62,000	48,3 / 36,4	0,41	8 SNR
EX207G2	35,000	72,000	51,1 / 37,6	0,60	8 SNR
EX208G2	40,000	80,000	56,3 / 42,8	0,78	8 SNR
EX209G2	45,000	85,000	56,3 / 42,8	0,87	8 SNR
EX210G2	50,000	90,000	62,7 / 49,2	1,01	8 SNR
EX211G2	55,000	100,000	71,3 / 55,4	1,39	8 SNR
EX212G2	60,000	110,000	77,7 / 61,8	1,87	8 SNR
EX213G2	65,000	120,000	85,7 / 68,2	2,41	8 SNR
EX214G2	70,000	125,000	85,7 / 68,2	2,57	8 SNR
EX215G2	75,000	130,000	92,1 / 74,6	2,84	8 SNR
EX216G2	80,000	140,000	95,2 / 74,6	3,12	8 SNR
EX217G2	85,000	150,000	73,2 / 53,2	3,72	8 SNR
EX218G2	90,000	160,000	72,5 / 55	4,90	8 SNR
EX305G2	25,000	62,000	46,8 / 34,9	0,43	8 SNR
EX306G2	30,000	72,000	50 / 36,5	0,68	8 SNR
EX307G2	35,000	80,000	51,6 / 38,1	0,80	8 SNR
EX308G2	40,000	90,000	57,1 / 41,3	1,08	8 SNR
EX309G2	45,000	100,000	58,7 / 42,9	1,45	8 SNR
EX310G2	50,000	110,000	66,6 / 49,2	1,86	8 SNR
EX311G2	55,000	120,000	73 / 55,6	2,30	8 SNR
EX312G2	60,000	130,000	79,4 / 61,9	2,89	8 SNR
EX313G2	65,000	140,000	85,7 / 65,1	3,66	8 SNR
EX314G2	70,000	150,000	92,1 / 68,3	4,50	8 SNR
EX315G2	75,000	160,000	100 / 74,6	5,34	8 SNR
EX316G2	80,000	170,000	106,4 / 81	6,70	8 SNR
EX317G2	85,000	180,000	109,5 / 84,1	7,96	8 SNR
EX318G2	90,000	190,000	115,9 / 87,3	9,10	8 SNR
EX319G2	95,000	200,000	122,3 / 93,7	10,40	8 SNR
EX320G2	100,000	215,000	128,6 / 100	13,00	8 SNR
F-6000J1LLU	10,000	26,000	8,000	0,02	1 NTN
F-6001J1LLU	12,000	28,000	8,000	0,02	1 NTN
F-6001J1ZZ	12,000	28,000	8,000	0,02	1 NTN
F-6005J1LLU	25,000	47,000	12,000	0,08	1 NTN
F-6006LLU	30,000	55,000	13,000	0,12	1 NTN
F-6008J1LLU	40,000	68,000	15,000	0,18	1 NTN
F-603	3,000	9,000	3,000	0,001	1 NTN
F-604ZZ	4,000	12,000	4,000	0,002	1 NTN
F-605ZZ	5,000	14,000	5,000	0,003	1 NTN
F-606ZZ	6,000	17,000	6,000	0,01	1 NTN
F-6080	400,000	600,000	90,000	87,60	1 NTN

Reference	d	D	B	Kg	Brands
F-608J1LLU	8,000	22,000	7,000	0,01	1 NTN
F-608LLU	8,000	22,000	7,000	0,01	1 NTN
F-6204	20,000	47,000	14,000	0,10	1 NTN
F-6205J1LLU	25,000	52,000	15,000	0,12	1 NTN
F-6207LLU	35,000	72,000	17,000	0,27	1 NTN
F-623ZZ	3,000	10,000	4,000	0,002	1 NTN
F-624ZZ	4,000	13,000	5,000	0,003	1 NTN
F-625ZZ	5,000	16,000	5,000	0,005	1 NTN
F-6304J1	20,000	52,000	15,000	0,14	1 NTN
F-673	3,000	6,000	2,000	0,000	1 NTN
F-674	4,000	7,000	2,000	0,000	1 NTN
F-675	5,000	8,000	2,000	0,000	1 NTN
F-676	6,000	10,000	2,500	0,001	1 NTN
F-677	7,000	11,000	3,000	0,001	1 NTN
F-678	8,000	12,000	2,500	0,001	1 NTN
F-679	9,000	13,000	3,000	0,001	1 NTN
F-682	2,000	5,000	1,500	0,000	1 NTN
F-683	3,000	7,000	2,000	0,000	1 NTN
F-684	4,000	9,000	2,500	0,001	1 NTN
F-685	5,000	11,000	3,000	0,001	1 NTN
F-686	6,000	13,000	3,500	0,002	1 NTN
F-687	7,000	14,000	3,500	0,002	1 NTN
F-688	8,000	16,000	4,000	0,003	1 NTN
F-689	9,000	17,000	4,000	0,003	1 NTN
F-6902J1LLU	15,000	28,000	7,000	0,02	1 NTN
F-6904LLU	20,000	37,000	9,000	0,03	1 NTN
F-692	2,000	6,000	2,300	0,000	1 NTN
F-693	3,000	8,000	3,000	0,001	1 NTN
F-694	4,000	11,000	4,000	0,002	1 NTN
F-694ZZ	4,000	11,000	4,000	0,002	1 NTN
F-6956F2	280,000	380,000	46,000	14,16	1 NTN
F-695AZZ	5,000	13,000	4,000	0,002	1 NTN
F-696	6,000	15,000	5,000	0,004	1 NTN
F-696ZZ	6,000	15,000	5,000	0,004	1 NTN
F-697	7,000	17,000	5,000	0,005	1 NTN
F-697LLU	7,000	17,000	5,000	0,005	1 NTN
F-698LLU	8,000	19,000	6,000	0,01	1 NTN
F-698ZZ	8,000	19,000	6,000	0,01	1 NTN
F-699LLU	9,000	20,000	6,000	0,01	1 NTN
F-699ZZ	9,000	20,000	6,000	0,01	1 NTN
F-699ZZ/22	9,000	20,000	6,000	0,01	1 NTN
F-7944DB	220,000	300,000	76,000	15,48	1 NTN
F-B-10	4,000	10,000	3,000	0,001	1 NTN
F-B-5	2,000	5,000	2,000	0,000	1 NTN
F-B-6	2,000	6,000	2,500	0,000	1 NTN
F-B-8	4,000	8,000	2,000	0,000	1 NTN
F-B-9	5,000	9,000	2,500	0,001	1 NTN
F-BC6-12	6,000	12,000	3,000	0,001	1 NTN
F-BC7-13	7,000	13,000	3,000	0,001	1 NTN
F-BC8-14	8,000	14,000	3,500	0,002	1 NTN
F-DF501ZZ	5,000	20,000	9,500	0,02	1 NTN
F-DF501ZZ1XGS12PX2/LX57Q1	5,000	20,000	9,500	0,016	5 NTN
F-FL604ZZ	4,000	12,000	4,000	0,002	1 NTN

Reference	d	D	B	Kg	?	Brands
F-FL605ZZ	5,000	14,000	5,000	0,004	1	NTN
F-FL606ZZ	6,000	17,000	6,000	0,01	1	NTN
F-FL623ZZ	3,000	10,000	4,000	0,002	1	NTN
F-FL686	6,000	13,000	3,500	0,002	1	NTN
F-FL688	8,000	16,000	4,000	0,004	1	NTN
F-FL693	3,000	8,000	3,000	0,001	1	NTN
F-FL694ZZ	4,000	11,000	4,000	0,002	1	NTN
F-FL695ZZ	5,000	13,000	4,000	0,003	1	NTN
F-FL696ZZ	6,000	15,000	5,000	0,004	1	NTN
F-FL697ZZ	7,000	17,000	5,000	0,01	1	NTN
F-FL698ZZ	8,000	19,000	6,000	0,01	1	NTN
F-FLAW678AZZ	8,000	12,000	3,500	0,001	1	NTN
F-FLAWB-10ZZ	4,000	10,000	4,000	0,001	1	NTN
F-FLAWBC6-12ZZ	6,000	12,000	4,000	0,002	1	NTN
F-FLAWBC7-13ZZ	7,000	13,000	4,000	0,002	1	NTN
F-FLB-10	5,000	10,000	3,000	0,001	1	NTN
F-FLB-8	4,000	8,000	2,000	0,001	1	NTN
F-FLBC6-12	6,000	12,000	3,000	0,001	1	NTN
F-FLW682SSA	2,000	5,000	2,300	0,000	1	NTN
F-FLW683ZZ	3,000	7,000	3,000	0,000	1	NTN
F-FLW684ASSA	4,000	9,000	4,000	0,001	1	NTN
F-FLW685ZZ	5,000	11,000	5,000	0,002	1	NTN
F-FLW686ZZ	6,000	13,000	5,000	0,003	1	NTN
F-FLW687AZZ	7,000	16,000	5,000	0,004	1	NTN
F-FLW688AZ	8,000	16,000	5,000	0,004	1	NTN
F-FLW688AZZ	8,000	16,000	5,000	0,004	1	NTN
F-FLW689ZZ	9,000	17,000	5,000	0,004	1	NTN
F-FLW693ZZ	3,000	8,000	4,000	0,001	1	NTN
F-FLWA673SSA	3,000	6,000	2,500	0,000	1	NTN
F-FLWA674ASSA	4,000	7,000	2,500	0,000	1	NTN
F-FLWA675ZZ	5,000	8,000	2,500	0,000	1	NTN
F-FLWA676AZZ	6,000	10,000	3,000	0,001	1	NTN
F-FLWB-11ZZ	5,000	11,000	4,000	0,002	1	NTN
F-FLWB-8ZZ	4,000	8,000	3,000	0,001	1	NTN
F-FLWB-9ZZ	5,000	9,000	3,000	0,001	1	NTN
F-FLWBC8-14LL	8,000	14,000	4,000	0,002	1	NTN
F-FLWBC8-14ZZ	8,000	14,000	4,000	0,002	1	NTN
FL605ZZ	5,000	16,000	5,000	0,004	1	NTN
FL606ZZ	6,000	17,000	6,000	0,01	1	NTN
FL625ZZ	5,000	18,000	5,000	0,01	1	NTN
FL698LLB	8,000	19,000	6,000	0,01	1	NTN
FL698Z	8,000	19,000	6,000	0,01	1	NTN
FL698ZZ	8,000	19,000	6,000	0,01	1	NTN
FLAW678AZZ	8,000	12,000	3,500	0,001	1	NTN
FLAWB-10ZZ	4,000	10,000	4,000	0,001	1	NTN
FLAWBC6-12ZZ	6,000	12,000	4,000	0,002	1	NTN
FLB-10	5,000	10,000	3,000	0,001	1	NTN
FLB-8	4,000	8,000	2,000	0,005	1	NTN
FLRA188ZZA	6,350	13,894	4,762	0,003	1	NTN
FLW688ALLU	8,000	16,000	5,000	0,004	1	NTN
FLWA674SSA	4,000	7,000	2,500	0,004	1	NTN

Reference	d	D	B	Kg	?	Brands
FLWA675ZZ	5,000	8,000	2,500	0,000	1	NTN
FLWA676ZZ	6,000	10,000	3,000	0,001	1	NTN
FLWB-13ZZ	5,000	15,000	5,000	0,004	1	NTN
FLWB-8ZZ	4,000	8,000	3,000	0,001	1	NTN
FLWBC8-14ZZ	8,000	14,000	4,000	0,002	1	NTN
F-R6	9,525	22,225	7,142	0,01	1	NTN
F-R6ZZ	9,525	22,225	7,142	0,01	1	NTN
F-S75	3,175	6,350	2,779	0,000	1	NTN
F-SC6A21	6,000	19,000	6,000	0,01	1	NTN
F-SX8A72LL	8,000	22,000	6,000	0,01	1	NTN
F-W603ZZ	3,000	9,000	5,000	0,002	1	NTN
F-W678AZZ	8,000	12,000	3,500	0,001	1	NTN
F-W679ZZ	9,000	14,000	4,500	0,002	1	NTN
F-W682SSA	2,000	5,000	2,300	0,000	1	NTN
F-W683ZZ	3,000	7,000	3,000	0,001	1	NTN
F-W684AZZ	4,000	9,000	4,000	0,001	1	NTN
F-W685Z1	5,000	11,000	5,000	0,002	1	NTN
F-W685ZZ	5,000	11,000	5,000	0,002	1	NTN
F-W686LL	6,000	13,000	5,000	0,003	1	NTN
F-W686ZZ	6,000	13,000	5,000	0,002	1	NTN
F-W687AZZ	7,000	14,000	5,000	0,003	1	NTN
F-W688ALLU	8,000	16,000	5,000	0,004	1	NTN
F-W688AZZ	8,000	16,000	5,000	0,004	1	NTN
F-W689Z1	9,000	17,000	5,000	0,004	1	NTN
F-W689ZZ	9,000	17,000	5,000	0,004	1	NTN
F-W69/15ASSA	1,500	5,000	2,000	0,002	1	NTN
F-W693ZZ	3,000	8,000	4,000	0,001	1	NTN
F-W693ZZS	3,000	8,000	4,000	0,001	1	NTN
F-WA673SSA	3,000	6,000	2,500	0,000	1	NTN
F-WA674ASSA	4,000	7,000	2,500	0,000	1	NTN
F-WA675ZZ	5,000	8,000	2,500	0,000	1	NTN
F-WA676AZZ	6,000	10,000	3,000	0,001	1	NTN
F-WA676ZZ	6,000	10,000	3,000	0,001	1	NTN
F-WA677ZZ	7,000	11,000	3,000	0,001	1	NTN
F-WB-10ZZ	4,000	10,000	4,000	0,001	1	NTN
F-WB-11ZZ	5,000	11,000	4,000	0,002	1	NTN
F-WB-13ZZ	5,000	13,000	5,000	0,003	1	NTN
F-WB-8ZZ	4,000	8,000	3,000	0,001	1	NTN
F-WB-9ZZ	5,000	9,000	3,000	0,001	1	NTN
F-WBC6-12LL	6,000	12,000	4,000	0,002	1	NTN
F-WBC6-12ZZ	6,000	12,000	4,000	0,002	1	NTN
F-WBC7-13ZZ	7,000	13,000	4,000	0,002	1	NTN
F-WBC8-14LL	8,000	14,000	4,000	0,002	1	NTN
F-WBC8-14ZZ	8,000	14,000	4,000	0,002	1	NTN
KRA100	254,000	266,700	6,350	0,20	1	NTN
KRC045	114,300	133,350	9,525	0,21	1	NTN
KRC055	139,700	158,750	9,525	0,25	1	NTN
KRJO55LL	139,700	158,750	12,700	0,34	1	NTN



Reference	d	D	B	Kg		Brands
KRJ060LL	152,400	171,450	12,700	0,37	1	NTN
KRJ065LL	165,100	184,150	12,700	0,38	1	NTN
KRJ070LL	177,800	196,850	12,700	0,42	1	NTN
KRJ075LL	190,500	209,550	12,700	0,44	1	NTN
KRJ090LL	228,600	247,650	12,700	0,47	1	NTN
KXA035	88,900	101,600	6,350	0,06	3	NTN
KXA042	107,950	120,650	6,350	0,09	3	NTN
KXA065	165,100	177,800	6,350	0,14	3	NTN
KXB090	228,600	244,475	7,938	0,25	3	NTN
KXC120	304,800	323,850	9,525	0,50	3	NTN
KXC140	355,600	374,650	9,525	0,77	3	NTN
KXD110	279,400	304,800	12,700	0,89	3	NTN
KXF100	254,000	292,100	19,050	1,65	3	NTN
KXF160	406,400	444,500	19,050	2,50	3	NTN
KXG140	355,600	406,400	25,400	4,09	3	NTN
KXG200	508,000	558,800	25,400	6,68	3	NTN
KXG350	889,000	939,800	25,400	9,90	3	NTN
KXJ065LL	165,100	184,150	12,700	0,38	3	NTN
KXS010	25,400	34,925	4,762	0,01	3	NTN
KYA020	50,800	63,500	6,350	0,04	2	NTN
KYA025	63,500	76,200	6,350	0,05	2	NTN
KYA030	76,200	88,900	6,350	0,06	2	NTN
KYA045	114,300	127,000	6,350	0,10	2	NTN
KYB025DB	63,500	79,375	15,876	0,17	2	NTN
KYD080DB	203,200	228,600	25,400	1,30	2	NTN
KYD100DB	254,000	279,400	25,400	1,70	2	NTN
KYF120	304,800	342,900	19,050	2,22	2	NTN
KYG090DF	228,600	279,400	50,800	3,24	2	NTN
KYS010DB	25,400	34,925	9,524	0,03	2	NTN
KYS015	38,100	47,620	4,760	0,02	2	NTN
QJ205	25,000	52,000	15,000	0,158	3	NTN
QJ210	50,000	90,000	20,000	0,58	3	NTN
QJ210C3	50,000	90,000	20,000	0,576	3	NTN
QJ211	55,000	100,000	21,000	0,74	3	NTN
QJ211T1	55,000	100,000	21,000	0,770	3	NTN
QJ212	60,000	110,000	22,000	0,97	3	NTN
QJ212C3	60,000	110,000	22,000	0,971	3	NTN
QJ213	65,000	120,000	23,000	1,24	3	NTN
QJ214CS136	70,000	125,000	24,000	1,360	3	NTN
QJ215	75,000	130,000	25,000	1,47	3	NTN
QJ215AL1BW-1C4P6S10	75,000	130,000	25,000	1,431	3	NTN
QJ215EX1C3U35K	75,000	130,000	25,000	1,471	3	NTN
QJ218	90,000	160,000	30,000	2,70	3	NTN
QJ218C4U35K	90,000	160,000	30,000	2,706	3	NTN
QJ218CS134	90,000	160,000	30,000	2,700	3	NTN
QJ218CS176U35K	90,000	160,000	30,000	2,707	3	NTN
QJ220	100,000	180,000	34,000	3,95	3	NTN
QJ220C3	100,000	180,000	34,000	3,951	3	NTN
QJ222	110,000	200,000	38,000	5,52	3	NTN
QJ222BWC3S30	110,000	200,000	38,000	5,620	3	NTN
QJ222X50C3	110,000	200,000	38,000	5,524	3	NTN
QJ224	120,000	215,000	40,000	6,56	3	NTN

Reference	d	D	B	Kg		Brands
QJ224ACS155	120,000	215,000	40,000	6,599	3	NTN
QJ224C3U35K	120,000	215,000	40,000	6,560	3	NTN
QJ224WC4	120,000	215,000	40,000	6,750	3	NTN
QJ226	130,000	230,000	40,000	7,50	3	NTN
QJ226WC4P36	130,000	230,000	40,000	7,750	3	NTN
QJ228WC4	140,000	250,000	42,000	9,720	3	NTN
QJ238	190,000	340,000	55,000	24,40	3	NTN
QJ238C3S30	190,000	340,000	55,000	24,400	3	NTN
QJ238WC3S30	190,000	340,000	55,000	24,400	3	NTN
QJ3/22AX2T2	22,000	56,000	16,000	0,190	3	NTN
QJ3/28	28,000	68,000	18,000	0,31	3	NTN
QJ3/28V1	28,000	68,000	18,000	0,309	3	NTN
QJ305	25,000	62,000	17,000	0,24	3	NTN
QJ305T2XC3	25,000	62,000	17,000	0,243	3	NTN
QJ306	30,000	72,000	19,000	0,327	3	NTN
QJ306MA	30,000	72,000	19,000	0,42	3	SNR
QJ307MA	35,000	80,000	21,000	0,58	3	SNR
QJ308	40,000	90,000	23,000	0,600	3	NTN
QJ308MA	40,000	90,000	23,000	0,77	3	SNR
QJ309MA	45,000	100,000	25,000	1,02	3	SNR
QJ310MA	50,000	110,000	27,000	1,38	3	SNR
QJ311	55,000	120,000	29,000	3,916	3	NTN
QJ311MA	55,000	120,000	29,000	1,68	3	SNR
QJ312MA	60,000	130,000	31,000	2,15	3	SNR
QJ312NR	60,000	130,000	31,000	1,717	3	NTN
QJ313MA	65,000	140,000	33,000	2,63	3	SNR
QJ314	70,000	150,000	35,000	3,17	3	NTN
QJ314C4U35K	70,000	150,000	35,000	3,170	3	NTN
QJ314MA	70,000	150,000	35,000	3,20	3	SNR
QJ314NR	70,000	150,000	35,000	2,56	3	NTN
QJ314NRCS138U35K	70,000	150,000	35,000	2,560	3	NTN
QJ315	75,000	160,000	37,000	3,081	3	NTN
QJ315N2MA	75,000	160,000	37,000	3,97	3	SNR
QJ316N2MA	80,000	170,000	39,000	4,52	3	SNR
QJ317N2MA	85,000	180,000	41,000	5,54	3	SNR
QJ318N2MA	90,000	190,000	43,000	6,44	3	SNR
QJ320	100,000	215,000	47,000	9,14	3	NTN
QJ320WC4	100,000	215,000	47,000	9,140	3	NTN
QJ321	105,000	225,000	49,000	10,40	3	NTN
QJ321WC4	105,000	225,000	49,000	10,400	3	NTN
QJ413	65,000	160,000	37,000	3,29	3	NTN
R10LLB	15,875	34,925	8,731	0,04	1	NTN
R10LLU	15,875	34,925	8,731	0,04	1	NTN
R10ZZ	15,875	34,925	8,731	0,04	1	NTN
R12LLB	19,050	41,275	11,112	0,07	1	NTN
R12LLU	19,050	41,275	11,112	0,07	1	NTN
R12ZZ	19,050	41,275	11,112	0,07	1	NTN
R133	2,380	7,938	2,779	0,12	1	NTN
R1-4	2,380	4,762	1,588	0,35	1	NTN
R144	3,175	7,938	2,779	0,27	1	NTN

Reference	d	D	B	Kg	Brands
R14LLB	22,225	47,625	12,700	0,10	1 NTN
R14LLU	22,225	47,625	12,700	0,10	1 NTN
R14ZZ	22,225	47,625	12,700	0,10	1 NTN
R1-5	3,175	6,350	2,380	0,69	1 NTN
R155	4,762	7,938	2,779	0,54	1 NTN
R156	4,762	9,525	3,175	0,44	1 NTN
R166	4,762	12,700	3,967	0,80	1 NTN
R166ZZ	4,762	9,525	3,175	0,001	1 NTN
R168A	6,350	12,700	3,175	0,60	1 NTN
R16LBLU	25,400	50,800	12,700	0,11	1 NTN
R16LLB	25,400	50,800	12,700	0,11	1 NTN
R16LLU	25,400	50,800	12,700	0,11	1 NTN
R16ZZ	25,400	50,800	12,700	0,11	1 NTN
R188	6,350	15,875	4,978	1,60	1 NTN
R18LLU	28,575	53,975	12,700	0,11	1 NTN
R18ZZ	28,575	53,975	12,700	0,11	1 NTN
R2	3,175	12,700	4,366	1,30	1 NTN
R20LL	31,750	57,150	12,700	0,13	1 NTN
R20LLB	31,750	57,150	12,700	0,13	1 NTN
R20ZZ	31,750	57,150	12,700	0,13	1 NTN
R2-5	3,175	9,525	2,779	0,61	1 NTN
R2-6	3,175	9,525	3,967	0,88	1 NTN
R2ZZA	3,175	9,525	3,967	0,001	1 NTN
R3	4,762	12,700	4,978	2,20	1 NTN
R4	6,350	15,875	4,978	0,004	1 NTN
R4LL	6,350	15,875	4,978	0,004	1 NTN
R4LLB	6,350	15,875	4,978	0,004	1 NTN
R4ZZ	6,350	15,875	4,978	0,004	1 NTN
R6LLB	9,525	22,220	7,140	0,01	1 NTN
R6LLU	9,525	22,220	7,140	0,01	1 NTN
R6Z	9,525	22,220	7,140	0,01	1 NTN
R6ZZ	9,525	22,225	7,142	0,01	1 NTN
RA188ZZ	6,350	12,700	4,762	0,002	1 NTN
RA2	3,967	7,938	2,779	2,50	1 NTN
RA3	6,350	9,525	3,175	2,40	1 NTN
RA3LL	4,762	12,700	4,978	0,003	1 NTN
RA3ZZ	4,762	12,700	4,978	0,003	1 NTN
S60002RS	10,000	26,000	8,000	0,02	1 SNR
S60012RS	12,000	28,000	8,000	0,02	1 SNR
S60022RS	15,000	32,000	9,000	0,03	1 SNR
S60032RS	17,000	35,000	10,000	0,07	1 SNR
S60042RS	20,000	42,000	12,000	0,07	1 SNR
S60052RS	25,000	47,000	12,000	0,08	1 SNR
S60062RS	30,000	55,000	13,000	0,12	1 SNR
S60072RS	35,000	62,000	14,000	0,16	1 SNR
S60082RS	40,000	68,000	15,000	0,19	1 SNR
S62002RS	10,000	30,000	9,000	0,03	1 SNR
S62012RS	12,000	32,000	10,000	0,03	1 SNR
S62022RS	15,000	35,000	11,000	0,05	1 SNR

Reference	d	D	B	Kg	Brands
S62032RS	17,000	40,000	12,000	0,07	1 SNR
S62042RS	20,000	47,000	14,000	0,11	1 SNR
S62052RS	25,000	52,000	15,000	0,13	1 SNR
S62062RS	30,000	62,000	16,000	0,20	1 SNR
S62072RS	35,000	72,000	17,000	0,28	1 SNR
S62082RS	40,000	80,000	18,000	0,37	1 SNR
S63002RS	10,000	35,000	11,000	0,05	1 SNR
S63012RS	12,000	37,000	12,000	0,06	1 SNR
S63042RS	20,000	52,000	15,000	0,15	1 SNR
S63052RS	25,000	62,000	17,000	0,23	1 SNR
SC0039ZZ	10,000	26,000	8,000	0,02	1 NTN
SC0046ZZ	10,000	26,000	8,000	0,02	1 NTN
SC0061ZZ	10,000	26,000	8,000	0,02	1 NTN
SC0077ZZA	10,000	15,000	4,000	0,002	1 NTN
SC00A18ZZ	10,000	26,000	8,000	0,02	1 NTN
SC01A21	11,000	16,000	4,000	0,002	1 NTN
SC01A33	13,000	32,000	7,000	0,03	1 NTN
SC01A36ZZ	12,000	21,000	5,000	0,01	1 NTN
SC01A38	13,000	28,000	6,350	0,02	1 NTN
SC0284	15,000	42,000	11,500	0,07	1 NTN
SC0288	15,000	35,000	8,500	0,04	1 NTN
SC0289LLH	15,000	32,000	10,000	0,03	1 NTN
SC0299LUZ	15,000	38,000	12,000	0,06	1 NTN
SC02A17	15,000	35,000	8,500	0,04	1 NTN
SC02A55	14,000	25,400	6,000	0,01	1 NTN
SC0342	17,000	47,000	11,500	0,10	1 NTN
SC0352LLUA	17,000	52,000	17,000	0,17	1 NTN
SC0390	17,000	52,000	12,000	0,14	1 NTN
SC0394	17,000	47,000	12,000	0,10	1 NTN
SC03A78	17,000	47,000	11,500	0,10	1 NTN
SC040	20,000	47,000	14,000	0,12	1 NTN
SC0409	20,000	42,000	9,000	0,05	1 NTN
SC041	22,000	33,500	7,000	0,02	1 NTN
SC041Z	22,000	33,500	7,000	0,02	1 NTN
SC041ZZ	22,000	33,500	7,000	0,01	1 NTN
SC0461	20,000	47,000	12,000	0,09	1 NTN
SC0493LLU	19,050	44,450	12,700	0,09	1 NTN
SC04A31	20,000	47,000	12,000	0,09	1 NTN
SC04A34	20,000	47,000	12,000	0,10	1 NTN
SC04A47	20,000	52,000	12,000	0,14	1 NTN
SC04A50	20,000	52,000	12,000	0,13	1 NTN
SC04A55LLB	21,300	35,000	7,000	0,03	1 NTN
SC04A73	22,000	56,000	15,000	0,17	1 NTN
SC04A84	20,000	47,000	10,500	0,08	1 NTN
SC04A89	22,000	56,000	14,000	0,16	1 NTN
SC04B16ZZ	22,225	40,000	12,000	0,07	1 NTN
SC04B19	20,000	56,000	12,000	0,17	1 NTN
SC04B25	20,000	55,000	11,000	0,13	1 NTN
SC04B27	20,000	52,000	12,000	0,14	1 NTN
SC04B66LLU	22,000	56,000	17,000	0,19	1 NTN
SC04C10	22,000	42,000	8,000	0,04	1 NTN
SC04C11	22,000	42,000	8,000	0,04	1 NTN



Reference	d	D	B	Kg	Brands
SC04C41	22,000	33,500	7,000	0,02	1 NTN
SC04C41Z	22,000	33,500	7,000	0,02	1 NTN
SC04C41ZZ	22,000	33,500	7,000	0,01	1 NTN
SC04C50	20,000	47,000	14,000	0,12	1 NTN
SC050LLUA	25,000	55,000	15,000	0,16	1 NTN
SC0555LU	25,000	58,000	16,000	0,18	1 NTN
SC0563	25,000	62,000	12,000	0,18	1 NTN
SC057	25,000	47,000	10,500	0,07	1 NTN
SC0596	24,000	37,000	6,000	0,02	1 NTN
SC05A51	25,000	52,000	13,000	0,12	1 NTN
SC05A58	26,000	64,000	16,000	0,24	1 NTN
SC05A59	26,000	70,000	17,000	0,31	1 NTN
SC05A61	26,000	58,000	15,000	0,16	1 NTN
SC05A82	26,000	37,000	6,000	0,02	1 NTN
SC05A97	25,000	56,000	12,000	0,14	1 NTN
SC05B26	26,000	68,000	14,000	0,25	1 NTN
SC05B27	25,000	62,000	15,000	0,20	1 NTN
SC05B31	25,000	68,000	12,000	0,24	1 NTN
SC05B43	26,000	75,000	19,000	0,39	1 NTN
SC05B61	25,000	56,000	12,000	0,14	1 NTN
SC05B76	26,000	62,000	14,000	0,19	1 NTN
SC05B88	25,000	56,000	12,000	0,14	1 NTN
SC05C05	25,000	56,000	12,000	0,14	1 NTN
SC05C27	25,000	47,000	10,500	0,07	1 NTN
SC05C50LLU	25,000	55,000	15,000	0,16	1 NTN
SC0612	28,575	53,970	9,400	0,09	1 NTN
SC0627	30,000	72,000	16,000	0,31	1 NTN
SC065C35LL	32,200	72,000	15,500	0,29	1 NTN
SC0663	31,750	57,150	9,520	0,10	1 NTN
SC0690	28,000	78,000	20,000	0,45	1 NTN
SC0698	30,000	55,000	11,000	0,10	1 NTN
SC06A68	28,000	60,000	15,000	0,18	1 NTN
SC06C19LL	30,000	72,000	16,500	0,31	1 NTN
SC06C88LL	30,000	62,000	23,000	0,29	1 NTN
SC06C88LLA	30,000	62,000	23,000	0,29	1 NTN
SC06D03	30,200	85,000	13,000	0,41	1 NTN
SC0732	34,000	57,000	13,000	0,11	1 NTN
SC0790	35,000	66,000	15,000	0,19	1 NTN
SC07A04	35,000	72,000	16,000	0,26	1 NTN
SC07A42LL	33,000	55,000	15,000	0,11	1 NTN
SC07B26D2	35,000	62,000	19,000	0,23	1 NTN
SC07B47	35,000	72,000	14,000	0,24	1 NTN
SC07B59	35,000	60,000	14,000	0,14	1 NTN
SC07B66Z	35,000	66,000	15,000	0,19	1 NTN
SC0828	40,000	90,000	20,000	0,57	1 NTN
SC0889LL	38,000	58,000	15,000	0,11	1 NTN
SC0890	42,000	70,000	11,000	0,15	1 NTN
SC08A80	40,000	80,000	16,500	0,34	1 NTN
SC08A92	40,000	80,000	16,500	0,35	1 NTN
SC08A93	40,000	84,000	19,000	0,46	1 NTN
SC0914	45,000	100,000	21,000	0,72	1 NTN

Reference	d	D	B	Kg	Brands
SC0915	45,000	100,000	21,000	0,70	1 NTN
SC0922	45,000	85,000	11,000	0,27	1 NTN
SC0929	43,000	68,000	13,000	0,15	1 NTN
SC0989D2	45,000	68,000	19,000	0,21	1 NTN
SC10006	500,000	689,000	100,000	103,00	1 NTN
SC1037	48,000	67,000	9,000	0,08	1 NTN
SC10403	520,000	719,000	100,000	118,00	1 NTN
SC1059LLU	50,000	127,000	40,000	2,23	1 NTN
SC10605	530,000	760,000	100,000	147,00	1 NTN
SC1084LLU	50,000	90,000	20,000	0,47	1 NTN
SC10A07ZZ	50,000	100,000	50,000	0,96	1 NTN
SC10A27LLU	50,000	130,000	34,000	2,17	1 NTN
SC10A28LLU	50,000	129,000	34,000	2,12	1 NTN
SC1108LU	57,150	90,488	15,880	0,33	1 NTN
SC11401	570,000	790,000	115,000	166,00	1 NTN
SC1159LLU	55,000	150,000	45,000	3,84	1 NTN
SC1165C3	55,000	130,000	29,000	1,76	1 NTN
SC1170LLB	55,000	130,000	29,000	1,79	1 NTN
SC12203	610,000	869,000	120,000	223,00	1 NTN
SC1221ZZ	60,000	130,000	33,000	1,81	1 NTN
SC12601	630,000	710,000	69,000	36,00	1 NTN
SC1278LLU	60,000	115,500	28,000	1,28	1 NTN
SC1279LLU	60,000	115,000	28,000	1,26	1 NTN
SC1282LLU	60,000	116,000	28,000	1,30	1 NTN
SC1291LLU	60,000	150,000	36,000	3,06	1 NTN
SC1298LLU	60,000	152,000	36,000	3,20	1 NTN
SC12A04LLBA	60,000	95,000	19,000	0,39	1 NTN
SC13007	650,000	919,000	118,000	246,00	1 NTN
SC1306	63,500	98,400	17,460	0,50	1 NTN
SC1324	63,500	98,407	17,462	0,43	1 NTN
SC1352	65,000	155,000	33,000	2,93	1 NTN
SC1355ZZ	65,000	140,000	35,000	2,23	1 NTN
SC14004	700,000	900,000	74,000	112,00	1 NTN
SC1407	69,850	104,775	17,462	0,46	1 NTN
SC1408LLU	70,000	110,000	36,000	0,80	1 NTN
SC1414	70,000	150,000	35,000	2,49	1 NTN
SC1420	70,000	150,000	35,000	2,58	1 NTN
SC1458	70,000	150,000	35,000	2,57	1 NTN
SC1467	70,000	100,000	12,000	0,27	1 NTN
SC1469	70,000	105,000	13,000	0,36	1 NTN
SC15002	750,000	1 070,000	140,000	403,00	1 NTN
SC1610ZZ	80,000	170,000	41,000	3,84	1 NTN
SC16401	820,000	1 160,000	160,000	524,00	1 NTN
SC16402	820,000	1 060,000	110,000	247,00	1 NTN
SC164028	820,000	1 060,000	110,000	247,00	1 NTN
SC1755LLU	85,000	170,000	45,000	4,16	1 NTN
SC1757LLU	85,000	171,000	45,000	4,22	1 NTN
SC18003	900,000	1 030,000	44,000	68,00	1 NTN
SC1812	88,900	127,000	19,050	0,75	1 NTN
SC1830ZZ	90,000	190,000	45,000	5,20	1 NTN
SC20003	1 000,000	1 380,000	190,000	838,00	1 NTN
SC2010	101,600	142,870	22,220	0,95	1 NTN

Reference	d	D	B	Kg	Brands
SC2308	114,300	158,720	22,220	1,12	1 NTN
SC2852Z	140,000	250,000	46,000	9,83	1 NTN
SC2951	145,000	220,000	38,000	5,07	1 NTN
SC30001	1 500,000	2 000,000	218,000	1 950,00	1 NTN
SC3002	150,000	230,000	35,000	5,51	1 NTN
SC3007	150,000	230,000	35,000	5,18	1 NTN
SC3207	160,000	229,500	36,000	4,72	1 NTN
SC3209	160,000	229,500	33,000	4,35	1 NTN
SC3210	160,000	230,000	33,000	5,36	1 NTN
SC3605	180,000	265,000	33,000	6,08	1 NTN
SC3705	185,000	269,500	38,000	6,20	1 NTN
SC3805	190,000	269,500	33,000	5,87	1 NTN
SC3904	195,000	270,000	35,000	6,04	1 NTN
SC414ZZ	4,000	12,700	7,000	0,004	1 NTN
SC4401	220,000	309,500	38,000	7,50	1 NTN
SC4405	220,000	319,500	46,000	12,32	1 NTN
SC4605	230,000	329,500	40,000	11,00	1 NTN
SC4608	230,000	329,500	40,000	9,27	1 NTN
SC4609	230,000	339,500	45,000	11,70	1 NTN
SC4806	240,000	329,500	40,000	10,20	1 NTN
SC4A28ZZ	4,000	13,000	5,000	0,004	1 NTN
SC5003	250,000	349,500	46,000	13,40	1 NTN
SC5206	260,000	379,500	56,000	17,80	1 NTN
SC5605	280,000	360,000	38,000	9,47	1 NTN
SC5803	290,000	419,500	60,000	26,80	1 NTN
SC6201	310,000	429,500	60,000	25,80	1 NTN
SC6203	310,000	450,000	50,000	25,90	1 NTN
SC6403	320,000	470,000	70,000	40,40	1 NTN
SC6406	320,000	449,500	56,000	27,60	1 NTN
SC6802	340,000	489,500	60,000	36,20	1 NTN
SC6809	340,000	489,500	65,000	40,00	1 NTN
SC6A17ZZ	6,000	15,000	5,000	0,004	1 NTN
SC6A17ZZN	6,000	15,000	5,000	0,004	1-NR NTN
SC6A22ZZ	6,000	13,000	5,000	0,003	1 NTN
SC6A30ZZ	6,000	13,000	5,000	0,003	1 NTN
SC7101	355,600	469,900	57,150	26,30	1 NTN
SC7205	360,000	509,500	70,000	45,00	1 NTN
SC731ZZ	7,000	17,000	4,000	0,004	1 NTN
SC7606	380,000	760,000	128,000	231,00	1 NTN
SC8002	400,000	720,000	130,000	226,00	1 NTN
SC8011	400,000	720,000	130,000	240,00	1 NTN
SC811LLU	8,000	22,000	10,000	0,02	1 NTN
SC850LLB	8,000	22,000	7,000	0,01	1 NTN
SC850LLBM	8,000	22,000	7,000	0,01	1 NTN
SC850ZZ	8,000	22,000	7,000	0,01	1 NTN
SC858ZZ	8,000	22,000	7,000	0,01	1 NTN
SC866ZZ	8,000	16,000	5,000	0,004	1 NTN
SC8803	440,000	599,000	80,000	65,00	1 NTN
SC890ZZ	8,000	16,000	5,000	0,004	1 NTN
SC8A18ZZ	8,000	22,000	7,000	0,01	1 NTN
SC8A58ZZ	8,000	22,000	7,000	0,01	1 NTN
SC8A58ZZM	8,000	22,000	7,000	0,01	1 NTN

Reference	d	D	B	Kg	Brands
SC8A91ZZ	8,000	19,000	6,000	0,01	1 NTN
SC8A91ZZM	8,000	19,000	6,000	0,01	1 NTN
SC8B07ZZ	8,000	26,250	4,800	0,02	1 NTN
SC9001	450,000	629,000	80,000	76,00	1 NTN
SC929ZZ	9,000	24,000	7,000	0,02	1 NTN
SC929ZZ1	9,000	24,000	7,000	0,02	1 NTN
SE0725	36,443	52,000	10,000	0,04	2 NTN
SE1211	60,000	130,000	31,000	2,10	2 NTN
SE12118	60,000	130,000	31,000	2,10	2 NTN
SE1305	65,000	140,000	33,000	2,60	2 NTN
SE1552	75,000	160,000	37,000	3,08	2 NTN
SE16003	800,000	1 150,000	155,000	444,00	2 NTN
SE18002	900,000	1 180,000	122,000	368,00	2 NTN
SE20002	1 000,000	1 380,000	190,000	876,00	2 NTN
SE21201	1 060,000	1 500,000	195,000	914,00	2 NTN
SE21302	1 066,800	1 168,400	50,800	60,10	2 NTN
SE25003	1 250,000	1 750,000	218,000	1 730,00	2 NTN
SE2501	125,000	209,000	33,000	4,70	2 NTN
SE2612	130,000	215,000	36,000	4,90	2 NTN
SE30002	1 500,000	2 000,000	218,000	2 016,00	2 NTN
SF0011	9,525	22,225	5,556	0,01	2 NTN
SF0161Z	12,000	28,000	8,000	0,02	2 NTN
SF0164LLB	12,000	32,000	10,000	0,04	2 NTN
SF0165ZZ	12,000	42,000	13,000	0,09	2 NTN
SF0228	15,000	32,000	9,000	0,03	2 NTN
SF02A12	15,000	35,000	11,000	0,04	2 NTN
SF0499	22,000	70,000	18,000	0,35	2 NTN
SF04A12	22,000	70,000	18,000	0,35	2 NTN
SF04A48	22,000	76,000	19,000	0,45	2 NTN
SF04A49	22,000	42,000	8,000	0,04	2 NTN
SF0581	26,000	47,000	15,000	0,10	2 NTN
SF05A26	26,000	47,000	15,000	0,07	2 NTN
SF05A40	25,000	47,000	8,000	0,06	2 NTN
SF05A78	25,000	47,000	8,000	0,06	2 NTN
SF05A84	26,000	72,000	15,500	0,32	2 NTN
SF05B05ZZ	25,000	55,000	13,000	0,14	2 NTN
SF0649	30,000	55,000	17,000	0,15	2 NTN
SF06A24	28,000	72,000	18,000	0,35	2 NTN
SF06A27	28,000	78,000	20,000	0,46	2 NTN
SF06A49	28,000	64,000	18,000	0,25	2 NTN
SF0724	33,000	60,000	14,700	0,15	2 NTN
SF0725	35,000	56,400	14,000	0,10	2 NTN
SF0743	33,000	60,000	17,100	0,16	2 NTN
SF07A17	35,000	55,000	14,500	0,09	2 NTN
SF07A22	35,000	55,000	14,500	0,09	2 NTN
SF07A88	35,000	72,000	17,000	0,29	2 NTN
SF0815	40,000	63,600	16,000	0,15	2 NTN
SF0816	38,100	67,000	16,400	0,19	2 NTN
SF0820	40,000	74,000	19,000	0,29	2 NTN
SF0859	40,000	67,000	20,000	0,25	2 NTN
SF08A67	40,000	80,000	18,000	0,37	2 NTN
SF0914	45,000	74,000	18,000	0,22	2 NTN



Reference	d	D	B	Kg	?	Brands
SF0937	45,000	77,000	22,000	0,29	2	NTN
SF0990	45,000	68,000	12,000	0,14	2	NTN
SF10013	560,000	700,000	100,000	87,30	2	NTN
SF1018	51,650	88,100	21,000	0,45	2	NTN
SF11206	562,000	748,000	85,000	105,00	2	NTN
SF11207	560,000	748,000	85,000	105,00	2	NTN
SF1135	55,000	85,600	19,400	0,36	2	NTN
SF1150	55,000	120,000	29,000	1,63	2	NTN
SF14001	700,000	900,000	74,000	117,00	2	NTN
SF1412	70,000	117,000	27,000	0,93	2	NTN
SF1452	70,000	125,000	24,000	1,07	2	NTN
SF1554	75,000	130,000	25,000	1,38	2	NTN
SF1634	80,000	140,000	26,000	1,61	2	NTN
SF1656	80,000	140,000	26,000	1,41	2	NTN
SF1657	82,000	103,000	11,500	0,18	2	NTN
SF1732	85,000	150,000	28,000	3,10	2	NTN
SF1752	85,000	150,000	28,000	2,18	2	NTN
SF18004DF	900,000	1 280,000	220,000	972,00	2	NTN
SF20001	1 000,000	1 420,000	130,000	654,00	2	NTN
SF20001DF	1 000,000	1 420,000	260,000	1 308,00	2	NTN
SF2052LB	100,000	150,000	16,000	0,99	2	NTN
SF2091	101,600	134,938	15,875	0,50	2	NTN
SF2109	105,000	160,000	26,000	1,86	2	NTN
SF2110	105,000	180,000	32,000	2,85	2	NTN
SF2118	105,000	138,000	15,000	0,95	2	NTN
SF2254	110,000	200,000	38,000	4,48	2	NTN
SF2255	109,000	138,000	13,000	0,39	2	NTN
SF2263	109,000	138,000	13,000	0,39	2	NTN
SF2518	126,000	154,000	14,400	0,44	2	NTN
SF2608	130,000	205,000	24,000	2,98	2	NTN
SF2652	130,000	199,500	33,000	3,74	2	NTN
SF2812V	140,000	175,000	18,000	0,83	2	NTN
SF2853	140,000	175,000	18,000	0,73	2	NTN
SF2855	140,000	175,000	18,000	0,73	2	NTN
SF2907	143,000	175,000	16,000	0,44	2	NTN
SF2912	145,000	200,000	27,000	1,77	2	NTN
SF2917	144,000	174,000	15,300	0,58	2	NTN
SF2951	145,000	220,000	38,000	5,15	2	NTN
SF3030DB	152,400	203,200	50,800	3,66	2	NTN
SF3033DB	150,000	225,000	70,000	9,03	2	NTN
SF3048	149,000	183,000	17,300	0,80	2	NTN
SF3050	149,000	183,000	16,500	0,77	2	NTN
SF3208	160,000	215,000	28,000	2,74	2	NTN
SF3209	160,000	229,500	33,000	4,52	2	NTN
SF3210	160,000	230,000	33,000	4,15	2	NTN
SF3210DF	160,000	230,000	66,000	8,57	2	NTN
SF3214	160,000	229,500	33,000	4,52	2	NTN
SF3227	160,000	200,000	20,000	0,77	2	NTN
SF3240	160,000	200,000	20,000	1,09	2	NTN
SF3242	160,000	210,000	24,000	1,73	2	NTN
SF3254	159,000	191,000	16,400	0,60	2	NTN

Reference	d	D	B	Kg	?	Brands
SF3313	165,000	210,000	24,000	1,52	2	NTN
SF3408DB	170,000	260,000	81,000	13,00	2	NTN
SF3421	168,000	205,000	20,000	1,01	2	NTN
SF3506	176,000	216,000	21,000	1,23	2	NTN
SF3607V	180,000	225,000	22,000	1,18	2	NTN
SF3618	180,000	259,500	33,000	5,70	2	NTN
SF3618DB	180,000	259,500	66,000	11,40	2	NTN
SF3624DB	180,000	250,000	63,000	7,89	2	NTN
SF3629	180,000	259,500	33,000	5,80	2	NTN
SF3629DF	180,000	259,500	66,000	11,60	2	NTN
SF3635DB	180,000	250,000	66,000	8,27	2	NTN
SF3639	180,000	259,500	33,000	5,75	2	NTN
SF3639DB	180,000	259,500	66,000	11,41	2	NTN
SF3641	180,000	259,500	33,000	5,65	2	NTN
SF3644DB	180,000	259,500	66,000	11,50	2	NTN
SF3654DB	180,000	265,000	66,000	11,50	2	NTN
SF3662	182,000	214,000	17,000	0,86	2	NTN
SF3802	190,000	269,500	33,000	5,95	2	NTN
SF3806	190,000	255,000	33,000	4,16	2	NTN
SF3806DB	190,000	255,000	66,000	8,74	2	NTN
SF3807	190,000	269,500	33,000	6,05	2	NTN
SF3816	190,000	259,500	33,000	5,10	2	NTN
SF3819DB	190,000	259,500	70,000	11,00	2	NTN
SF3832	188,000	250,000	30,000	3,19	2	NTN
SF3833	190,000	236,000	21,000	1,80	2	NTN
SF3835	190,000	236,000	21,000	1,49	2	NTN
SF3836DB	190,000	269,500	66,000	12,00	2	NTN
SF3901	195,000	270,000	35,000	6,20	2	NTN
SF4006	200,000	279,500	38,000	7,15	2	NTN
SF4017	200,000	289,500	38,000	8,25	2	NTN
SF4017DF	200,000	289,500	76,000	13,90	2	NTN
SF4019	200,000	260,000	30,000	3,23	2	NTN
SF4021	200,000	250,000	24,000	1,49	2	NTN
SF4030DB	200,000	280,000	72,000	14,50	2	NTN
SF4044DB	200,000	279,500	76,000	14,30	2	NTN
SF4104	203,200	330,200	88,900	14,70	2	NTN
SF4211	210,000	300,000	40,000	9,05	2	NTN
SF4224	210,000	280,000	35,000	4,56	2	NTN
SF4229	210,000	262,000	24,000	2,33	2	NTN
SF4230	208,000	260,000	23,000	2,27	2	NTN
SF4308	214,000	264,000	25,500	2,39	2	NTN
SF4309	214,000	264,000	25,500	2,44	2	NTN
SF4403DB	220,000	300,000	76,000	15,10	2	NTN
SF4407	220,000	300,000	38,000	7,25	2	NTN
SF4407DB	220,000	300,000	76,000	14,50	2	NTN
SF4409DB	220,000	319,500	92,000	24,50	2	NTN
SF4421	220,000	309,500	38,000	8,90	2	NTN
SF4421DB	220,000	309,500	76,000	8,95	2	NTN
SF4433	220,000	309,500	38,000	8,90	2	NTN
SF4438	220,000	319,500	46,000	12,20	2	NTN
SF4454	220,000	295,000	33,000	4,70	2	NTN
SF4460	220,000	295,000	32,000	4,80	2	NTN

Reference	d	D	B	Kg	?	Brands
SF4466	220,000	295,000	32,000	4,80	2	NTN
SF4467	220,000	295,000	33,000	4,80	2	NTN
SF4469	220,000	276,000	26,000	2,79	2	NTN
SF4470DB	220,000	309,500	76,000	17,50	2	NTN
SF4614	230,000	329,500	40,000	11,00	2	NTN
SF4615	230,000	300,000	35,000	5,32	2	NTN
SF4639	230,000	300,000	35,000	4,56	2	NTN
SF4649	230,000	290,000	26,000	3,24	2	NTN
SF4651	230,000	290,000	26,000	3,24	2	NTN
SF4802	240,000	340,000	40,000	11,50	2	NTN
SF4810	240,000	300,000	28,000	4,31	2	NTN
SF4814	240,000	329,500	40,000	10,10	2	NTN
SF4815	240,000	310,000	33,000	4,90	2	NTN
SF4818	240,000	329,500	40,000	10,10	2	NTN
SF4818DB	240,000	329,500	80,000	10,20	2	NTN
SF4831	240,000	310,000	33,000	4,90	2	NTN
SF4839	240,000	329,500	40,000	10,00	2	NTN
SF4840	240,000	310,000	33,000	4,81	2	NTN
SF4860	240,000	320,000	38,000	6,96	2	NTN
SF4903	246,000	308,000	32,000	3,97	2	NTN
SF4910	243,000	312,000	33,000	5,00	2	NTN
SF5004	250,000	349,500	46,000	13,60	2	NTN
SF5005	250,000	340,000	38,000	9,55	2	NTN
SF5005DB	250,000	340,000	76,000	19,10	2	NTN
SF5008DB	250,000	349,500	92,000	25,30	2	NTN
SF5015	250,000	320,000	35,000	5,21	2	NTN
SF5110	255,000	310,000	27,500	3,36	2	NTN
SF5111	255,000	310,000	27,500	3,40	2	NTN
SF5206	260,000	369,500	46,000	16,10	2	NTN
SF5210	260,000	369,500	46,000	15,70	2	NTN
SF5210DF	260,000	369,500	92,000	26,40	2	NTN
SF5218	260,000	379,500	56,000	19,10	2	NTN
SF5218DF	260,000	379,500	112,000	0,000	2	NTN
SF5220	260,000	340,000	38,000	7,79	2	NTN
SF5224	260,000	369,500	46,000	15,70	2	NTN
SF5225	260,000	369,500	46,000	15,70	2	NTN
SF5234	260,000	340,000	38,000	7,02	2	NTN
SF5245	260,000	330,000	35,000	5,16	2	NTN
SF5246	260,000	340,000	38,000	6,93	2	NTN
SF5405	270,000	350,000	40,000	8,82	2	NTN
SF5606	280,000	389,500	46,000	16,00	2	NTN
SF5606DB	280,000	389,500	92,000	28,10	2	NTN
SF5608	280,000	389,500	46,000	16,00	2	NTN
SF5608DF	280,000	389,500	92,000	28,10	2	NTN
SF5615DB	280,000	380,000	92,000	30,00	2	NTN
SF5622	281,000	354,000	37,000	6,70	2	NTN
SF5626DB	280,000	389,500	92,000	28,10	2	NTN
SF5627	280,000	400,000	48,000	15,30	2	NTN
SF5702	285,000	380,000	46,000	14,70	2	NTN
SF5803	290,000	419,500	60,000	26,90	2	NTN
SF5813DB	290,000	409,500	112,000	22,90	2	NTN
SF5910	297,000	355,000	27,000	1,00	2	NTN

Reference	d	D	B	Kg	?	Brands
SF6015	300,000	372,000	36,000	6,90	2	NTN
SF6021	300,000	368,000	34,000	6,17	2	NTN
SF6022DF	300,000	419,500	112,000	46,33	2	NTN
SF612	6,000	19,000	6,000	0,08	2	NTN
SF612DT	6,000	19,000	12,000	0,02	2	NTN
SF6203	310,000	429,500	60,000	26,70	2	NTN
SF6203DB	310,000	429,500	120,000	25,30	2	NTN
SF624DF	6,000	19,000	12,000	0,02	2	NTN
SF6419	320,000	383,000	30,000	5,41	2	NTN
SF6420	320,000	395,000	35,000	7,60	2	NTN
SF6605	328,000	404,000	38,000	8,26	2	NTN
SF6807	340,000	479,500	65,000	36,70	2	NTN
SF6807DF	340,000	479,500	130,000	72,00	2	NTN
SF6811DB	340,000	479,500	130,000	72,00	2	NTN
SF7008	350,000	400,000	25,000	3,51	2	NTN
SF703G	7,000	19,000	6,000	0,01	2	NTN
SF7113	355,000	435,000	40,550	10,28	2	NTN
SF7203	360,000	509,500	70,000	45,00	2	NTN
SF7601	380,000	540,000	164,000	61,00	2	NTN
SF7603	380,000	519,500	65,000	41,30	2	NTN
SF7603DB	380,000	519,500	130,000	82,60	2	NTN
SF8011	400,000	598,000	90,000	82,00	2	NTN
SF8012	402,000	600,000	90,000	83,00	2	NTN
SF802	8,000	22,000	7,000	0,01	2	NTN
SF802DB	8,000	22,000	14,000	0,02	2	NTN
SF821DT	8,000	22,000	14,000	0,02	2	NTN
SF821DTT	8,000	22,000	21,000	0,04	2	NTN
SF9211	460,000	540,000	40,000	15,80	2	NTN
SF9404	470,000	570,000	50,000	25,70	2	NTN
SSN00LL	10,000	26,000	8,000	0,02	1	NTN
SSN001LL	12,000	28,000	8,000	0,02	1	NTN
SSN001ZZ	12,000	28,000	8,000	0,02	1	NTN
SSN002LL	15,000	32,000	9,000	0,03	1	NTN
SSN002ZZ	15,000	32,000	9,000	0,03	1	NTN
SSN003LL	17,000	35,000	10,000	0,04	1	NTN
SSN004LL	20,000	42,000	12,000	0,07	1	NTN
SSN004ZZ	20,000	42,000	12,000	0,07	1	NTN
SSN005LL	25,000	47,000	12,000	0,08	1	NTN
SSN005ZZ	25,000	47,000	12,000	0,08	1	NTN
SSN006LL	30,000	55,000	13,000	0,11	1	NTN
SSN006ZZ	30,000	55,000	13,000	0,11	1	NTN
SSN007LL	35,000	62,000	14,000	0,15	1	NTN
SSN007ZZ	35,000	62,000	14,000	0,15	1	NTN
SSN008ZZ	40,000	68,000	15,000	0,18	1	NTN
SSN200LL	10,000	30,000	9,000	0,03	1	NTN
SSN201LL	12,000	32,000	10,000	0,04	1	NTN



Reference	d	D	B	Kg	?	Brands
SSN202LL	15,000	35,000	11,000	0,04	1	NTN
SSN202ZZ	15,000	35,000	11,000	0,04	1	NTN
SSN203LL	17,000	40,000	12,000	0,06	1	NTN
SSN204LL	20,000	47,000	14,000	0,10	1	NTN
SSN204ZZ	20,000	47,000	14,000	0,10	1	NTN
SSN205LL	25,000	52,000	15,000	0,12	1	NTN
SSN205ZZ	25,000	52,000	15,000	0,12	1	NTN
SSN206LL	30,000	62,000	16,000	0,17	1	NTN
SSN206ZZ	30,000	62,000	16,000	0,17	1	NTN
SSN207ZZ	35,000	72,000	17,000	0,27	1	NTN
SSN208LL	40,000	80,000	18,000	0,36	1	NTN
SSN208ZZ	40,000	80,000	18,000	0,36	1	NTN
SSN209LL	45,000	85,000	19,000	0,41	1	NTN
SSN303ZZ	17,000	47,000	14,000	0,11	1	NTN
SSN304ZZ	20,000	52,000	15,000	0,14	1	NTN
SSN802ZZ	15,000	24,000	5,000	0,01	1	NTN
SSN901LL	12,000	24,000	6,000	0,01	1	NTN
SSN902LL	15,000	28,000	7,000	0,02	1	NTN
SSN904LL	20,000	37,000	9,000	0,04	1	NTN
SSN904ZZ	20,000	37,000	9,000	0,03	1	NTN
SSN905ZZ	25,000	42,000	9,000	0,04	1	NTN
SX0011LL	10,000	32,000	8,000	0,04	2	NTN
SX0087ZZ	10,000	32,836	6,000	0,01	2	NTN
SX0197ZZ	12,000	42,000	10,000	0,03	2	NTN
SX01A28LLBA1	12,705	38,092	11,112	0,06	2	NTN
SX01A32	13,000	31,000	13,000	0,04	2	NTN
SX01A34ZZ	12,700	38,100	11,100	0,07	2	NTN
SX0344LLU	17,000	62,000	17,600	0,23	2	NTN
SX03A48LLUA	17,000	35,000	7,000	0,03	2	NTN
SX03A49LLUA	17,000	35,000	9,000	0,03	2	NTN
SX0401ZZ	20,000	52,000	20,000	0,20	2	NTN
SX0469	20,000	47,000	14,000	0,11	2	NTN
SX0483	22,000	56,000	14,000	0,16	2	NTN
SX04A29	20,000	47,000	14,000	0,10	2	NTN
SX04A34	22,000	65,000	18,000	0,26	2	NTN
SX04A77	20,000	47,000	18,000	0,12	2	NTN
SX04A81	22,000	54,000	14,000	0,14	2	NTN
SX04A90	22,000	56,000	15,000	0,16	2	NTN
SX04B25	22,000	52,000	14,000	0,13	2	NTN
SX0562LLU	25,000	54,000	15,000	0,17	2	NTN
SX0565LLU	25,000	54,000	15,000	0,20	2	NTN
SX05A52	24,000	56,000	14,000	0,15	2	NTN
SX05A66	25,000	48,000	27,000	0,11	2	NTN
SX05A87	25,000	52,000	15,000	0,12	2	NTN
SX05B22LLH	25,000	62,000	17,000	0,22	2	NTN
SX05B59	24,000	46,500	10,000	0,07	2	NTN
SX05B80	22,800	69,500	13,000	0,22	2	NTN
SX05B81LU	25,000	56,000	16,000	0,16	2	NTN
SX0621	30,000	62,000	11,303	0,14	2	NTN
SX0658LL	30,000	62,000	22,000	0,26	2	NTN
SX066	30,000	75,000	18,000	0,35	2	NTN
SX0673	30,000	72,000	26,200	0,42	2	NTN

Reference	d	D	B	Kg	?	Brands
SX0687LL	30,000	110,000	62,000	0,000	2	NTN
SX0688LL	30,000	120,000	62,000	3,48	2	NTN
SX06B79LLU	30,000	62,000	25,000	0,27	2	NTN
SX06C02N	31,000	75,000	16,500	0,33	2	NTN
SX06C03LLH	32,000	72,000	19,000	0,30	2	NTN
SX06C12LLH	32,000	80,000	21,000	0,44	2	NTN
SX0702LLU	35,000	88,000	25,000	0,60	2	NTN
SX071LLU	35,000	91,000	30,000	0,70	2	NTN
SX072LLU	35,000	118,000	30,000	1,53	2	NTN
SX0730LL	35,000	82,000	27,000	0,58	2	NTN
SX073LLU	35,000	111,000	36,000	1,55	2	NTN
SX0768LLU	35,000	72,000	33,000	0,37	2	NTN
SX077	34,000	60,000	22,000	0,19	2	NTN
SX0772LLU	35,000	72,000	35,000	0,58	2	NTN
SX0773LLU	35,000	72,000	44,000	0,33	2	NTN
SX07A25LLU	35,000	82,300	27,099	0,61	2	NTN
SX07B65LLU	35,000	72,000	26,000	0,33	2	NTN
SX07B72	34,000	68,000	20,000	0,26	2	NTN
SX07B98LZ	35,700	55,000	15,000	0,18	2	NTN
SX07C02LLU	35,000	120,000	30,400	1,50	2	NTN
SX07D68LLU	35,000	75,000	25,000	0,67	2	NTN
SX07E20LLU	35,000	101,350	28,580	1,26	2	NTN
SX0860LLU	38,892	77,762	19,710	0,36	2	NTN
SX087LLU	40,000	118,000	37,000	1,65	2	NTN
SX088LLB	40,000	74,000	41,000	0,31	2	NTN
SX08A05	40,000	100,000	23,000	0,58	2	NTN
SX08A50	40,000	90,000	23,000	0,58	2	NTN
SX0964LLU	45,000	118,000	40,000	1,92	2	NTN
SX0965LLU	45,000	117,000	40,000	1,87	2	NTN
SX09A09LLU	45,000	110,000	40,000	1,54	2	NTN
SX09A41LLU	45,000	135,000	36,000	2,25	2	NTN
SX09A52LLU	45,000	101,350	28,500	0,98	2	NTN
SX09A99LLU	45,000	118,000	32,000	1,67	2	NTN
SX09B01LLU	45,000	117,000	32,000	1,63	2	NTN
SX1059LLU	50,000	127,000	40,000	2,23	2	NTN
SX1084LLU	50,000	90,000	20,000	0,47	2	NTN
SX10A07ZZ	50,000	100,000	50,000	0,96	2	NTN
SX10A27LLU	50,000	130,000	34,000	2,17	2	NTN
SX10A28LLU	50,000	129,000	34,000	2,12	2	NTN
SX1159LLU	55,000	150,000	45,000	3,84	2	NTN
SX1165	55,000	130,000	29,000	1,76	2	NTN
SX1170LLB	55,000	130,000	29,000	1,79	2	NTN
SX1278LLU	60,000	115,500	28,000	1,28	2	NTN
SX1279LLU	60,000	115,000	28,000	1,26	2	NTN
SX1282LLU	60,000	116,000	28,000	1,30	2	NTN
SX1291LLU	60,000	150,000	36,000	3,06	2	NTN
SX1298LLU	60,000	152,000	36,000	3,20	2	NTN
SX12A04LLB	60,000	95,000	19,000	0,39	2	NTN
SX12A04LLBA	60,000	95,000	19,000	0,39	2	NTN
SX1352	65,000	155,000	33,000	2,93	2	NTN
SX1408LLU	70,000	110,000	36,000	0,80	2	NTN
SX1755LLU	85,000	170,000	45,000	4,16	2	NTN

Reference	d	D	B	Kg	?	Brands
SX1757LLU	85,000	171,000	45,000	4,22	2	NTN
SX2057LLU	100,000	205,000	52,000	6,80	2	NTN
SX2059LLU	100,000	203,000	52,000	6,49	2	NTN
SX2453LLU	120,000	245,000	66,000	12,70	2	NTN
SX3A41	3,000	8,000	4,000	0,002	2	NTN
SX4A07ZZ	4,000	18,000	6,000	0,002	2	NTN
SX6A17ZZ	6,000	17,000	10,000	0,004	2	NTN
SX6A61LBLU	6,000	16,000	6,000	0,005	2	NTN
SX6A61LUZ	6,000	16,000	6,000	0,005	2	NTN
SX753Z1	7,000	16,000	8,900	0,01	2	NTN
TA-QJ219BCS236U35K	95,000	170,000	32,000	3,350	3	NTN
TM-DF0555NRC3	25,000	52,000	20,600	0,176	5	NTN
TM-DF0581N	25,000	60,000	27,000	0,330	5	NTN
TM-DF05A28CS18	24,000	56,000	22,100	0,239	5	NTN
TM-DF1359CS32V4	66,000	126,000	33,500	1,219	5	NTN
TM-QJ216CS136U35K	80,000	140,000	26,000	1,830	3	NTN
TM-QJ219BCS236U35K	95,000	170,000	32,000	2,625	3	NTN
TM-QJ224CCS256U35K	120,000	215,000	40,000	6,560	3	NTN
TM-QJ226BC3	130,000	230,000	40,000	7,640	3	NTN
TM-QJ240AC3S30	200,000	360,000	58,000	27,500	3	NTN
TM-QJ240AWC3S30	200,000	360,000	58,000	27,500	3	NTN
TM-QJ314C4U35K	70,000	150,000	35,000	2,569	3	NTN
TS2-DF1402	70,000	110,000	36,000	1,083	5	NTN
TS2-QJ413C4U35K	65,000	160,000	37,000	3,290	3	NTN
TS3-DF0365LLBA1CS20PX1/LX03Q3	17,000	40,000	18,000	0,110	5	NTN
TS3-DF0365LLBA2C3/LX03	17,000	40,000	18,000	0,107	5	NTN
TS3-DF0365LLBA2CS22/LX03Q2	17,000	40,000	18,000	0,107	5	NTN
TS3-DF0365LLBA2V1	17,000	40,000	18,000	0,106	5	NTN
TS3-EC-DF1301LUALAC-S43PX1/L325	65,000	100,000	40,500	0,864	5	NTN
UC201D1	12,000	47,000	31 / 17	0,21	7	NTN
UC201G2	12,000	47,000	31 / 16	0,21	7	SNR
UC202D1	15,000	47,000	31 / 17	0,20	7	NTN
UC202G2	15,000	47,000	31 / 16	0,20	7	SNR
UC203D1	17,000	47,000	31 / 17	0,18	7	NTN
UC203G2	17,000	47,000	31 / 16	0,18	7	SNR
UC204D1	20,000	47,000	31 / 17	0,17	7	NTN
UC204G2	20,000	47,000	31 / 16	0,17	7	SNR
UC205D1	25,000	52,000	34,1 / 17	0,20	7	NTN
UC205G2	25,000	52,000	34 / 17	0,21	7	SNR
UC206	30,000	62,000	38,1 / 19	0,33	7	NTN-SNR
UC207	35,000	72,000	42,9 / 20	0,49	7	NTN-SNR
UC208	40,000	80,000	49,2 / 21	0,65	7	NTN-SNR
UC209	45,000	85,000	49,2 / 22	0,70	7	NTN-SNR
UC210D1	50,000	90,000	51,6 / 24	0,80	7	NTN
UC210G2	50,000	90,000	51,6 / 23	0,80	7	SNR
UC211	55,000	100,000	55,6 / 25	1,08	7	NTN-SNR
UC212	60,000	110,000	65,1 / 27	1,53	7	NTN-SNR
UC213D1	65,000	120,000	65,1 / 32	1,85	7	NTN
UC213G2	65,000	120,000	65,1 / 28	1,86	7	SNR
UC214D1	70,000	125,000	74,6 / 33	2,10	7	NTN
UC214G2	70,000	125,000	74,6 / 30	2,05	7	SNR
UC215D1	75,000	130,000	77,8 / 34	2,35	7	NTN

Reference	d	D	B	Kg	?	Brands
UC215G2	75,000	130,000	77,8 / 30	2,21	7	SNR
UC216D1	80,000	140,000	82,6 / 35	2,80	7	NTN
UC216G2	80,000	140,000	82,6 / 33	2,79	7	SNR
UC217D1	85,000	150,000	85,7 / 36	3,37	7	NTN
UC217G2	85,000	150,000	85,7 / 35	3,38	7	SNR
UC218	90,000	160,000	96 / 37	4,36	7	NTN-SNR
UC305D1	25,000	62,000	38 / 20	0,35	7	NTN
UC305G2	25,000	62,000	38 / 21	0,35	7	SNR
UC306D1	30,000	72,000	43 / 23	0,56	7	NTN
UC306G2	30,000	72,000	43 / 24	0,56	7	SNR
UC307	35,000	80,000	48 / 25	0,71	7	NTN-SNR
UC308D1	40,000	90,000	52 / 27	0,96	7	NTN
UC308G2	40,000	90,000	52 / 28	0,96	7	SNR
UC309D1	45,000	100,000	57 / 29	1,28	7	NTN
UC309G2	45,000	100,000	57 / 30	1,28	7	SNR
UC310	50,000	110,000	61 / 32	1,65	7	NTN-SNR
UC311	55,000	120,000	66 / 34	2,07	7	NTN-SNR
UC312	60,000	130,000	71 / 36	2,60	7	NTN-SNR
UC313D1	65,000	140,000	75 / 39	3,25	7	NTN
UC313G2	65,000	140,000	75 / 38	3,25	7	SNR
UC314D1	70,000	150,000	78 / 41	3,89	7	NTN
UC314G2	70,000	150,000	78 / 40	3,95	7	SNR
UC315D1	75,000	160,000	82 / 43	4,72	7	NTN
UC315G2	75,000	160,000	82 / 42	4,33	7	SNR
UC316D1	80,000	170,000	86 / 45	5,55	7	NTN
UC316G2	80,000	170,000	86 / 44	5,57	7	SNR
UC317D1	85,000	180,000	96 / 47	6,67	7	NTN
UC317G2	85,000	180,000	96 / 46	6,84	7	SNR
UC318D1	90,000	190,000	96 / 49	7,56	7	NTN
UC318G2	90,000	190,000	96 / 48	7,87	7	SNR
UC319D1	95,000	200,000	103 / 51	8,70	7	NTN
UC319G2	95,000	200,000	103 / 50	8,91	7	SNR
UC320D1	100,000	215,000	108 / 55	10,80	7	NTN
UC320G2	100,000	215,000	108 / 54	11,20	7	SNR
UC321	105,000	225,000	112 / 57	12,20	7	NTN-SNR
UC322D1	110,000	240,000	117 / 59	14,30	7	NTN
UC322G2	110,000	240,000	117 / 60	14,30	7	SNR
UC324D1	120,000	260,000	126 / 63	18,50	7	NTN
UC324G2	120,000	260,000	126 / 64	18,50	7	SNR
UC326D1	130,000	280,000	135 / 67	23,00	7	NTN
UC326G2	130,000	280,000	135 / 68	23,00	7	SNR
UC328D1	140,000	300,000	145 / 71	28,50	7	NTN
UC328G2	140,000	300,000	145 / 73	28,50	7	SNR
UCS201LD1N	12,000	47,000	31 / 17	0,21	13	NTN
UCS202LD1N	15,000	47,000	31 / 17	0,20	13	NTN
UCS203LD1N	17,000	47,000	31 / 17	0,18	13	NTN
UCS204LD1N	20,000	47,000	31 / 17	0,17	13	NTN
UCS205LD1N	25,000	52,000	34,1 / 17	0,20	13	NTN
UCS206LD1N	30,000	62,000	38,1 / 19	0,33	13	NTN
UCS207LD1N	35,000	72,000	42,9 / 20	0,49	13	NTN
UCS208LD1N	40,000	80,000	49,2 / 21	0,65	13	NTN
UCS209LD1N	45,000	85,000	49,2 / 22	0,70	13	NTN



Reference	d	D	B	Kg		Brands
UCS210LD1N	50,000	90,000	51,6 / 24	0,80	13	NTN
UCS211LD1N	55,000	100,000	55,6 / 25	1,08	13	NTN
UCS212LD1N	60,000	110,000	65,1 / 27	1,59	13	NTN
UCS213D1	65,000	120,000	65,1 / 32	1,92	13	NTN
UCS214D1	70,000	125,000	74,6 / 33	2,17	13	NTN
UCS215D1	75,000	130,000	77,8 / 34	2,43	13	NTN
UCS216D1	80,000	140,000	82,6 / 35	2,89	13	NTN
UCS217D1	85,000	150,000	85,7 / 36	3,47	13	NTN
UCS218D1	90,000	160,000	96 / 37	4,46	13	NTN
UCS305D1	25,000	62,000	38 / 20	0,37	13	NTN
UCS306D1	30,000	72,000	43 / 23	0,58	13	NTN
UCS307D1	35,000	80,000	48 / 25	0,74	13	NTN
UCS308D1	40,000	90,000	52 / 27	1,00	13	NTN
UCS309D1	45,000	100,000	57 / 29	1,33	13	NTN
UCS310D1	50,000	110,000	61 / 32	1,72	13	NTN
UCS311D1	55,000	120,000	66 / 34	2,15	13	NTN
UCS312D1	60,000	130,000	71 / 36	2,70	13	NTN
UCS313D1	65,000	140,000	75 / 39	3,37	13	NTN
UCS314D1	70,000	150,000	78 / 41	4,03	13	NTN
UCS315D1	75,000	160,000	82 / 43	4,88	13	NTN
UCS316D1	80,000	170,000	86 / 45	5,74	13	NTN
UCS317D1	85,000	180,000	96 / 47	6,88	13	NTN
UCS318D1	90,000	190,000	96 / 49	7,80	13	NTN
UCS319D1	95,000	200,000	103 / 51	8,97	13	NTN
UCS320D1	100,000	215,000	108 / 55	11,10	13	NTN
UCS321D1	105,000	225,000	112 / 57	12,60	13	NTN
UCS322D1	110,000	240,000	117 / 59	14,70	13	NTN
UCS324D1	120,000	260,000	126 / 63	19,00	13	NTN
UCS326D1	130,000	280,000	135 / 67	23,60	13	NTN
UCS328D1	140,000	300,000	145 / 71	29,20	13	NTN
UCX05	25,000	62,000	38,1 / 19	0,39	7	NTN
UCX06	30,000	72,000	42,9 / 20	0,68	7	NTN
UCX07	35,000	80,000	49,2 / 21	0,82	7	NTN
UCX08	40,000	85,000	49,2 / 22	0,93	7	NTN
UCX09	45,000	90,000	51,6 / 24	1,00	7	NTN
UCX10	50,000	100,000	55,6 / 25	1,35	7	NTN
UCX11	55,000	110,000	65,1 / 27	1,90	7	NTN
UCX12	60,000	120,000	65,1 / 32	2,27	7	NTN
UCX13	65,000	125,000	74,6 / 33	2,45	7	NTN
UCX14	70,000	130,000	77,8 / 34	2,47	7	NTN
UCX15	75,000	140,000	82,6 / 35	3,11	7	NTN
UCX16	80,000	150,000	85,7 / 36	3,79	7	NTN
UCX17	85,000	160,000	96 / 37	4,82	7	NTN
UCX18	90,000	170,000	104 / 39	5,51	7	NTN
UCX20	100,000	190,000	117,5 / 44	8,95	7	NTN
UEL204D1	20,000	47,000	43,7 / 34,2	0,23	8	NTN
UEL205D1	25,000	52,000	44,4 / 34,9	0,27	8	NTN
UEL206D1	30,000	62,000	48,4 / 36,5	0,45	8	NTN
UEL207D1	35,000	72,000	51,1 / 37,6	0,60	8	NTN
UEL208D1	40,000	80,000	56,3 / 42,8	0,79	8	NTN
UEL209D1	45,000	85,000	56,3 / 42,8	0,85	8	NTN

Reference	d	D	B	Kg		Brands
UEL210D1	50,000	90,000	62,7 / 49,2	0,98	8	NTN
UEL211D1	55,000	100,000	71,4 / 55,5	1,32	8	NTN
UEL212D1	60,000	110,000	77,8 / 61,9	1,87	8	NTN
UEL213D1	65,000	120,000	85,7 / 68,3	2,48	8	NTN
UEL214D1	70,000	125,000	85,7 / 68,3	2,47	8	NTN
UEL215D1	75,000	130,000	92 / 74,6	2,68	8	NTN
UEL305D1	25,000	62,000	46,8 / 34,9	0,43	8	NTN
UEL306D1	30,000	72,000	50 / 36,5	0,69	8	NTN
UEL307D1	35,000	80,000	51,6 / 38,1	0,80	8	NTN
UEL308D1	40,000	90,000	57,1 / 41,3	1,08	8	NTN
UEL309D1	45,000	100,000	58,7 / 42,9	1,45	8	NTN
UEL310D1	50,000	110,000	66,6 / 49,2	1,86	8	NTN
UEL311D1	55,000	120,000	73 / 55,6	2,34	8	NTN
UEL312D1	60,000	130,000	79,4 / 61,9	2,94	8	NTN
UEL313D1	65,000	140,000	85,7 / 65,1	3,67	8	NTN
UEL314D1	70,000	150,000	92,1 / 68,3	4,40	8	NTN
UEL315D1	75,000	160,000	100 / 74,6	5,34	8	NTN
UEL316D1	80,000	170,000	106,4 / 81	6,70	8	NTN
UEL317D1	85,000	180,000	109,5 / 84,1	8,00	8	NTN
UEL318D1	90,000	190,000	115,9 / 87,3	9,10	8	NTN
UEL319D1	95,000	200,000	122,3 / 93,7	10,40	8	NTN
UEL320D1	100,000	215,000	128,6 / 100	12,50	8	NTN
UEL321D1	105,000	225,000	139,7 / 104,8	14,60	8	NTN
UEL322D1	110,000	240,000	141,3 / 106,4	17,20	8	NTN
UELS204LD1N	20,000	47,000	43,7 / 34,2	0,23	14	NTN
UELS205LD1N	25,000	52,000	44,4 / 34,9	0,27	14	NTN
UELS206LD1N	30,000	62,000	48,4 / 36,5	0,45	14	NTN
UELS207LD1N	35,000	72,000	51,1 / 37,6	0,60	14	NTN
UELS208LD1N	40,000	80,000	56,3 / 42,8	0,79	14	NTN
UELS209LD1N	45,000	85,000	56,3 / 42,8	0,85	14	NTN
UELS210LD1N	50,000	90,000	62,7 / 49,2	0,98	14	NTN
UELS211LD1N	55,000	100,000	71,4 / 55,5	1,32	14	NTN
UELS212LD1N	60,000	110,000	77,8 / 61,9	1,93	14	NTN
UELS305D1N	25,000	62,000	46,8 / 34,9	0,45	14	NTN
UELS306D1N	30,000	72,000	50 / 36,5	0,71	14	NTN
UELS307D1N	35,000	80,000	51,6 / 38,1	0,83	14	NTN
UELS308D1N	40,000	90,000	57,1 / 41,3	1,12	14	NTN
UELS309D1N	45,000	100,000	58,7 / 42,9	1,50	14	NTN
UELS310D1N	50,000	110,000	66,6 / 49,2	1,93	14	NTN
UELS311D1N	55,000	120,000	73 / 55,6	2,42	14	NTN
UELS312D1N	60,000	130,000	79,4 / 61,9	3,04	14	NTN
UELS313D1N	65,000	140,000	85,7 / 65,1	3,79	14	NTN
UELS314D1N	70,000	150,000	92,1 / 68,3	4,54	14	NTN
UELS315D1N	75,000	160,000	100 / 74,6	5,50	14	NTN
UELS316D1N	80,000	170,000	106,4 / 81	6,89	14	NTN
UELS317D1N	85,000	180,000	109,5 / 84,1	8,21	14	NTN
UELS318D1N	90,000	190,000	115,9 / 87,3	9,34	14	NTN
UK209G2H	40,000	85,000	30 / 22	0,81	9	SNR
UK210D1	50,000	90,000	32 / 24	0,97	9	NTN
UK210G2H	45,000	90,000	31 / 23	0,95	9	SNR
UK211D1	55,000	100,000	35 / 25	1,26	9	NTN
UK211G2H	50,000	100,000	33 / 25	1,19	9	SNR

Reference	d	D	B	Kg		Brands
UK212D1	60,000	110,000	38 / 27	1,59	9	NTN
UK212G2H	55,000	110,000	36 / 27	1,51	9	SNR
UK213D1	65,000	120,000	40 / 32	2,00	9	NTN
UK213G2H	60,000	120,000	36 / 28	1,92	9	SNR
UK215D1	75,000	130,000	44 / 34	2,56	9	NTN
UK215G2H	65,000	130,000	41 / 30	2,72	9	SNR
UK216D1	80,000	140,000	45 / 35	3,23	9	NTN
UK216G2H	70,000	140,000	44 / 33	3,24	9	SNR
UK217D1	85,000	150,000	46 / 36	3,93	9	NTN
UK217G2H	75,000	150,000	44 / 35	3,87	9	SNR
UK218D1	90,000	160,000	47 / 37	4,74	9	NTN
UK218G2H	80,000	160,000	48 / 37	4,69	9	SNR
UK305D1	25,000	62,000	26 / 20	0,36	9	NTN
UK305G2H	20,000	62,000	27 / 21	0,49	9	SNR
UK306D1	30,000	72,000	29 / 23	0,59	9	NTN
UK306G2H	25,000	72,000	30 / 24	0,59	9	SNR
UK307D1	35,000	80,000	33 / 25	0,75	9	NTN
UK307G2H	30,000	80,000	33 / 25	0,92	9	SNR
UK308D1	40,000	90,000	34 / 27	1,02	9	NTN
UK308G2H	35,000	90,000	35 / 28	1,03	9	SNR
UK309D1	45,000	100,000	37 / 29	1,38	9	NTN
UK309G2H	40,000	100,000	38 / 30	1,47	9	SNR
UK310D1	50,000	110,000	41 / 32	1,68	9	NTN
UK310G2H	45,000	110,000	40 / 32	1,74	9	SNR
UK311D1	55,000	120,000	44 / 34	2,06	9	NTN
UK311G2H	50,000	120,000	43 / 34	2,20	9	SNR
UK312D1	60,000	130,000	47 / 36	2,53	9	NTN
UK312G2H	55,000	130,000	47 / 36	2,54	9	SNR
UK313D1	65,000	140,000	49 / 39	3,08	9	NTN
UK313G2H	60,000	140,000	49 / 38	3,27	9	SNR
UK315D1	75,000	160,000	55 / 43	4,84	9	NTN
UK315G2H	65,000	160,000	55 / 42	5,03	9	SNR
UK316D1	80,000	170,000	58 / 45	5,75	9	NTN
UK316G2H	70,000	170,000	55 / 44	5,83	9	SNR
UK317D1	85,000	180,000	60 / 47	6,72	9	NTN
UK317G2H	75,000	180,000	60 / 46	6,89	9	SNR
UK318D1	90,000	190,000	64 / 49	7,87	9	NTN
UK318G2H	80,000	190,000	60 / 48	7,94	9	SNR
UK319D1	95,000	200,000	67 / 51	9,02	9	NTN
UK319G2H	85,000	200,000	66 / 50	9,23	9	SNR
UK320D1	100,000	215,000	73 / 55	11,10	9	NTN
UK320G2H	90,000	215,000	68 / 54	10,97	9	SNR
UK322D1	110,000	240,000	80 / 59	14,90	9	NTN
UK322G2H	100,000	240,000	80 / 60	17,64	9	SNR
UK324D1	120,000	260,000	86 / 63	18,00	9	NTN
UK324G2H	110,000	260,000	86 / 64	21,19	9	SNR
UK326D1	130,000	280,000	90 / 67	23,30	9	NTN
UK326G2H	115,000	280,000	92 / 68	27,90	9	SNR
UK328D1	140,000	300,000	95 / 71	28,90	9	NTN
UK328G2H	125,000	300,000	98 / 73	34,45	9	SNR
US201G2	12,000	40,000	22 / 12	0,09	10	SNR
US202G2	15,000	40,000	22 / 12	0,08	10	SNR

Reference	d	D	B	Kg		Brands
US203G2	17,000	40,000	22 / 12	0,10	10	SNR
US204G2	20,000	47,000	25 / 14	0,13	10	SNR
US205G2	25,000	52,000	27 / 15	0,17	10	SNR
US206G2	30,000	62,000	30 / 16	0,27	10	SNR
US207G2	35,000	72,000	32 / 17	0,42	10	SNR
US208G2	40,000	80,000	34 / 18	0,60	10	SNR
US209G2	45,000	85,000	41,2 / 19	0,65	10	SNR
US210G2	50,000	90,000	43,5 / 20	0,76	10	SNR
US211G2	55,000	100,000	45,3 / 23	1,07	10	SNR
US212G2	60,000	110,000	53,7 / 24	1,30	10	SNR
W6700LLF	10,000	15,000	4,000	0,002	1	NTN
W678AZZ	8,000	12,000	3,500	0,001	1	NTN
W682SSA	2,000	5,000	2,300	0,000	1	NTN
W683ZZ	3,000	7,000	3,000	0,001	1	NTN
W684ASSA	4,000	9,000	4,000	0,001	1	NTN
W685ZZ	5,000	11,000	5,000	0,002	1	NTN
W686ZZ	6,000	13,000	5,000	0,003	1	NTN
W687AZZ	7,000	14,000	5,000	0,003	1	NTN
W688ALB	8,000	16,000	5,000	0,003	1	NTN
W688ALLU	8,000	16,000	5,000	0,003	1	NTN
W688AZ	8,000	16,000	5,000	0,004	1	NTN
W688AZZ	8,000	16,000	5,000	0,004	1	NTN
W689ZZ	9,000	17,000	5,000	0,004	1	NTN
W689ZZS	9,000	17,000	5,000	0,004	1	NTN
W692SSA	2,000	6,000	3,000	0,000	1	NTN
W693Z	3,000	8,000	4,000	0,001	1	NTN
W693ZZ	3,000	8,000	4,000	0,001	1	NTN
WA673SSA	3,000	6,000	2,500	0,000	1	NTN
WA674AZZ	4,000	7,000	2,500	0,000	1	NTN
WA676AZZ	6,000	10,000	3,000	0,001	1	NTN
WA676ZZ	6,000	10,000	3,000	0,001	1	NTN
WA677ZZ	7,000	11,000	3,000	0,001	1	NTN
WB-10ZZ	4,000	10,000	4,000	0,001	1	NTN
WB-11ZZ	5,000	11,000	4,000	0,002	1	NTN
WB-5SSA	2,000	5,000	2,500	0,000	1	NTN
WB-8ZZ	4,000	8,000	3,000	0,001	1	NTN
WBC5-11Z	5,000	11,000	4,000	2,00	1	NTN
WBC6-12ZZ	6,000	12,000	4,000	0,002	1	NTN
WBC8-14LL	8,000	14,000	4,000	0,002	1	NTN
WBC8-14ZZ	8,000	14,000	4,000	0,002	1	NTN
WC87013	13,000	32,000	12,700	0,04	1	NTN
WC87016	16,000	35,000	12,700	0,05	1	NTN
WC87037	7,000	22,000	10,319	0,02	1	NTN
WC87500	10,000	30,000	12,700	0,04	1	NTN
WC87502	15,000	35,000	12,700	0,05	1	NTN
WC87504	20,000	47,000	15,875	0,11	1	NTN
WC88503	17,000	40,000	16,601	0,09	1	NTN



Cylindrical roller bearing



Zylinderrollenlager



Rodamientos de rodillos cilíndricos



Цилиндрические роликоподшипники



Roulements à rouleaux cylindriques



Cuscinetti a rulli cilindrici



Rolamentos de rolos cilíndricos



Łożyska walcowe



Classification by references – Classification par références

Klassifizierung nach Referenzen – Classificazione per codice

Clasificación por referencias – Classificação por referências

Классификация по кодам – Klasyfikacja wg numerów katalogowych

Reference	d		B	Kg	?	Brands
	d	D				
2R1010K	50,000	110,000	45,500	1,98	24	NTN
2R1013	50,789	90,000	70,000	1,86	24	NTN
2R11203	560,000	880,000	260,000	546,00	24	NTN
2R1417K	70,000	150,000	56,500	4,63	24	NTN
2R1418	70,000	105,000	60,000	1,75	24	NTN
2R1420	70,000	105,000	94,000	2,70	24	NTN
2R1609K	80,000	170,000	64,500	7,78	24	NTN
2R1747	85,000	150,000	100,000	7,00	24	NTN
2R1748	85,000	150,000	130,000	8,69	24	NTN
2R1842LLU	90,000	285,000	107,000	32,00	24	NTN
2R1922K	95,000	200,000	75,000	12,10	24	NTN
2R2057VLL	30,000	260,000	89,000	22,20	24	NTN
2R2067	100,000	225,000	100,000	22,20	24	NTN
2R2472LL	120,000	220,000	282,000	34,90	24	NTN
2R2480	120,000	200,000	80,000	9,74	24	NTN
2R2481	120,000	200,000	80,000	9,94	24	NTN
2R2482LL	120,000	220,000	240,000	30,00	24	NTN
2R2486LL	120,000	220,000	296,000	33,30	24	NTN
2R2492LL	120,000	220,000	308,500	35,80	24	NTN
2R2670LL	130,000	240,000	209,000	34,40	24	NTN
2R2677V	130,000	180,000	50,000	3,87	24	NTN
2R2904V	145,000	210,000	85,000	10,00	24	NTN
2R3050	150,000	250,000	100,000	19,80	24	NTN
2R3051	150,000	250,000	100,000	19,80	24	NTN
2R3055K	151,500	230,000	168,000	25,00	24	NTN
2R3061V	150,000	210,000	65,000	7,08	24	NTN
2R3612	180,000	240,000	76,000	8,94	24	NTN
2R3616V	180,000	310,000	120,000	34,90	24	NTN
2R3618	180,000	380,000	126,000	64,30	24	NTN
2R4029	200,000	340,000	175,000	68,21	24	NTN
2R4031VK	200,000	340,000	115,000	45,00	24	NTN
2R4413V	220,000	370,000	125,000	63,00	24	NTN
2R4414V	220,000	370,000	195,000	67,50	24	NTN
2R5215	260,000	420,000	216,000	122,90	24	NTN
2R5613V	280,000	420,000	235,000	95,00	24	NTN
2R6010	300,000	460,000	118,000	65,40	24	NTN
2R6015	300,000	410,000	143,000	55,00	24	NTN
2R7603	380,000	570,000	135,000	111,00	24	NTN
2RE2827	140,000	220,000	120,000	16,00	24	NTN
2RE2828	140,000	220,000	120,000	16,00	24	NTN
2RE8404	420,000	740,000	320,000	565,00	24	NTN
2RN0819	40,000	80,000	36,000	0,78	24	NTN
2RN1414	70,000	150,000	70,000	5,73	24	NTN
2RN4024	200,000	420,000	160,000	109,60	24	NTN
2RNS2102	260,000	480,000	200,000	109,60	24	NTN
2RNS212	260,000	480,000	260,000	212,90	24	NTN
2RNS213	260,000	540,000	300,000	306,00	24	NTN
2RNS214	260,500	480,000	260,000	234,00	24	NTN
2RNU0619	30,000	62,000	24,000	0,32	24	NTN
2RNU10006	500,000	920,000	336,000	1 020,00	24	NTN
2RNU10101	505,000	820,000	290,000	656,00	24	NTN
2RNU10602	530,000	920,000	330,000	976,00	24	NTN

Reference	d		B	Kg	?	Brands
	d	D				
2RNU10803	540,000	960,000	343,000	1 170,00	24	NTN
2RNU11603	580,000	1 000,000	350,000	1 200,00	24	NTN
2RNU12101	605,000	980,000	290,000	935,00	24	NTN
2RNU13401	670,000	1 160,000	410,000	1 790,00	24	NTN
2RNU2231	110,000	138,000	150,000	27,20	24	NTN
2RNU2625	130,000	280,000	215,000	58,80	24	NTN
2RNU4412	220,000	340,000	142,000	42,60	24	NTN
2RNU4413	220,000	440,000	200,000	145,60	24	NTN
2RNU7605	380,000	680,000	240,000	348,00	24	NTN
2RNU7606	380,000	680,000	240,000	355,00	24	NTN
2RNU8403	420,000	730,000	230,000	460,00	24	NTN
2RNU8404	420,000	700,000	280,000	440,70	24	NTN
2RNU8802	440,000	780,000	280,000	630,00	24	NTN
2RNU8804	440,000	780,000	280,000	630,00	24	NTN
2RNU9404	470,000	890,000	325,000	945,00	24	NTN
2RNU9406	470,000	810,000	300,000	680,00	24	NTN
2RNU9610	480,000	875,000	260,000	724,00	24	NTN
2RNU2653	130,000	235,000	170,000	28,80	24	NTN
2RT10404	520,000	1 000,000	140,000	446,00	36	NTN
2RT11207	560,000	660,000	50,000	50,00	36	NTN
2RT11213	559,000	762,000	102,000	144,00	36	NTN
2RT11215	560,000	850,000	175,000	387,00	36	NTN
2RT12013	600,000	1 130,000	175,000	660,00	36	NTN
2RT12015	600,000	1 130,000	175,000	660,00	36	NTN
2RT12101	605,000	960,000	125,000	326,00	36	NTN
2RT12201	610,000	813,000	102,000	186,00	36	NTN
2RT13502	677,000	1 060,000	127,000	390,00	36	NTN
2RT14003	670,000	1 130,000	200,000	860,00	36	NTN
2RT1419	72,000	102,000	12,500	0,19	36	NTN
2RT14204	710,000	950,000	345,000	628,00	36	NTN
2RT14208	710,000	950,000	145,000	312,00	36	NTN
2RT1422	69,850	118,230	33,320	1,49	36	NTN
2RT15002	730,000	1 280,000	225,000	1 130,00	36	NTN
2RT15302	765,000	1 250,000	175,000	772,00	36	NTN
2RT15901	793,000	1 055,000	100,000	223,00	36	NTN
2RT16009	800,000	1 373,124	192,024	1 200,00	36	NTN
2RT16301	812,700	1 016,000	127,000	258,00	36	NTN
2RT17002	850,000	1 120,000	160,000	460,00	36	NTN
2RT18001	900,000	1 375,000	200,000	987,00	36	NTN
2RT18204	910,000	1 430,000	180,000	945,00	36	NTN
2RT18801	440,000	670,000	160,000	186,00	36	NTN
2RT19004V	450,000	680,000	190,000	272,00	36	NTN
2RT19005V	450,000	680,000	280,000	284,00	36	NTN
2RT19008	950,000	1 250,000	180,000	644,00	36	NTN
2RT19402	970,000	1 550,000	200,000	1 225,00	36	NTN
2RT19602	980,000	1 600,000	175,000	1 250,00	36	NTN
2RT19605	980,000	1 600,000	190,000	1 520,00	36	NTN
2RT19606	980,000	1 600,000	181,000	1 256,00	36	NTN
2RT19607	480,000	790,000	308,000	552,00	36	NTN
2RT20006	1 110,000	1 750,000	220,000	1 829,00	36	NTN
2RT2034	100,000	210,000	67,000	12,10	36	NTN
2RT2046	101,600	187,325	58,738	7,15	36	NTN

Reference	d	D	B	Kg	Brands
2RT20501	1 023,000	1 600,000	192,000	1 410,00	36 NTN
2RT21801	1 090,000	1 580,000	175,000	1 288,00	36 NTN
2RT21902	1 093,724	1 601,724	192,024	1 453,00	36 NTN
2RT21904	1 093,600	1 601,724	192,024	1 370,00	36 NTN
2RT22101	1 105,000	1 600,000	175,000	1 165,00	36 NTN
2RT22604	1 130,000	1 750,000	190,000	1 350,00	36 NTN
2RT2420	120,000	240,000	75,000	14,80	36 NTN
2RT24201	1 210,000	1 700,000	200,000	1 320,00	36 NTN
2RT25201	1 260,000	1 850,000	240,000	2 260,00	36 NTN
2RT28204	1 410,000	2 100,000	240,000	2 760,00	36 NTN
2RT28205	1 410,000	2 000,000	200,000	1 870,00	36 NTN
2RT28206	1 410,000	2 000,000	200,000	1 602,00	36 NTN
2RT3215	160,000	300,000	70,000	24,00	36 NTN
2RT3623	177,800	395,350	88,900	62,00	36 NTN
2RT3627	177,800	355,600	114,300	43,00	36 NTN
2RT3629	177,800	395,351	130,000	60,00	36 NTN
2RT3632	180,000	340,000	55,000	24,70	36 NTN
2RT3814	190,000	320,000	75,000	26,40	36 NTN
2RT4028	200,000	340,000	75,000	30,80	36 NTN
2RT4030	200,000	340,000	85,000	35,00	36 NTN
2RT4032	200,000	400,000	122,000	66,70	36 NTN
2RT4046	200,000	378,000	75,000	41,10	36 NTN
2RT4416	220,000	360,000	85,000	32,60	36 NTN
2RT4426	222,250	520,760	114,300	123,50	36 NTN
2RT4427	222,250	520,700	165,000	202,00	36 NTN
2RT5106	254,000	420,010	76,200	44,10	36 NTN
2RT5202	260,000	370,000	85,000	31,90	36 NTN
2RT6016	300,000	540,000	145,000	157,00	36 NTN
2RT8608	432,000	610,000	102,000	102,00	36 NTN
2RT8807	440,000	540,000	45,000	39,00	36 NTN
2RT9101	457,000	660,000	102,000	105,00	36 NTN
2RT9202	460,000	710,000	150,000	240,00	36 NTN
2RT9605	480,000	960,000	175,000	562,00	36 NTN
3RCS2626	130,000	300,000	172,640	70,00	27 NTN
3RCS2660	130,000	300,000	172,640	70,00	27 NTN
3RCS2666	130,000	300,000	172,640	70,00	27 NTN
3RCS2668	130,000	300,000	172,640	70,00	27 NTN
3RCS2671	130,000	300,000	172,640	73,30	27 NTN
3RCS3615	180,000	406,400	171,040	132,00	27 NTN
3RCS3621	180,000	406,400	171,040	126,80	27 NTN
4R10006	500,000	690,000	510,000	640,00	28 NTN
4R10008	500,000	710,000	480,000	675,00	28 NTN
4R10010	500,000	680,000	420,000	495,00	28 NTN
4R10011	500,000	700,000	515,000	680,00	28 NTN
4R10015	500,000	720,000	530,000	780,00	28 NTN
4R10016	500,000	690,000	470,000	590,00	28 NTN
4R10020	500,000	680,000	420,000	451,00	28 NTN
4R10024	500,000	720,000	530,000	745,00	28 NTN
4R10201	510,000	670,000	320,000	335,00	28 NTN
4R10202	510,000	700,000	540,000	689,00	28 NTN
4R10402	520,000	735,000	535,000	740,00	28 NTN
4R10403	520,000	700,000	540,000	658,00	28 NTN

Reference	d	D	B	Kg	Brands
4R10406	520,000	720,000	550,000	715,00	28 NTN
4R10601	530,000	760,000	520,000	800,00	28 NTN
4R10602	530,000	780,000	570,000	1 010,00	28 NTN
4R10603	530,000	700,000	540,000	626,00	28 NTN
4R10606	530,000	780,000	570,000	978,00	28 NTN
4R10704	536,180	762,030	558,800	859,00	28 NTN
4R11001	550,000	800,000	520,000	965,00	28 NTN
4R11202	560,000	680,000	360,000	265,00	28 NTN
4R11402	570,000	815,000	594,000	1 040,00	28 NTN
4R11404	570,000	800,000	514,000	849,00	28 NTN
4R12001	600,000	870,000	640,000	1 330,00	28 NTN
4R12002	600,000	870,000	540,000	1 150,00	28 NTN
4R12006	600,000	820,000	575,000	941,00	28 NTN
4R12202	610,000	870,000	660,000	1 400,00	28 NTN
4R12602	628,000	922,000	600,000	1 430,00	28 NTN
4R12802	640,000	880,000	600,000	1 150,00	28 NTN
4R13003	650,000	920,000	690,000	1 550,00	28 NTN
4R13005	650,000	920,000	670,000	1 500,00	28 NTN
4R13010	650,000	920,000	680,000	1 510,00	28 NTN
4R13201	660,000	820,000	440,000	580,00	28 NTN
4R13603	680,000	1 020,000	650,000	1 970,00	28 NTN
4R13604	680,000	1 020,000	680,000	2 060,00	28 NTN
4R13802	690,000	980,000	715,000	1 850,00	28 NTN
4R13803	690,000	980,000	750,000	1 900,00	28 NTN
4R14205	710,000	1 000,000	715,000	1 900,00	28 NTN
4R14501	725,000	1 000,000	700,000	1 730,00	28 NTN
4R15001	750,000	1 050,000	745,000	2 180,00	28 NTN
4R15002	750,000	1 090,000	745,000	2 530,00	28 NTN
4R15101	755,000	1 070,000	750,000	2 260,00	28 NTN
4R15201	761,430	1 079,600	787,400	2 420,00	28 NTN
4R15203	760,000	1 100,000	745,000	2 560,00	28 NTN
4R15204	760,000	1 030,000	750,000	2 000,00	28 NTN
4R15207	760,000	1 080,000	805,000	2 550,00	28 NTN
4R16004	800,000	1 080,000	700,000	1 950,00	28 NTN
4R16005	800,000	1 080,000	750,000	2 090,00	28 NTN
4R16403	820,000	1 160,000	840,000	2 930,00	28 NTN
4R16405	820,000	1 130,000	825,000	2 520,00	28 NTN
4R16406	820,000	1 130,000	800,000	2 450,00	28 NTN
4R16413	820,000	1 130,000	800,000	2 530,00	28 NTN
4R16415	820,000	1 130,000	800,000	2 530,00	28 NTN
4R16601	830,000	1 080,000	710,000	1 780,00	28 NTN
4R16801	840,000	1 160,000	840,000	2 840,00	28 NTN
4R17001	850,000	1 150,000	650,000	1 980,00	28 NTN
4R17002	850,000	1 180,000	850,000	2 970,00	28 NTN
4R17003	850,000	1 150,000	800,000	2 430,00	28 NTN
4R17004	850,000	1 180,000	650,000	2 270,00	28 NTN
4R17009	850,000	1 150,000	840,000	2 640,00	28 NTN
4R17014	850,000	1 180,000	850,000	2 980,00	28 NTN
4R17201	860,000	1 160,000	735,000	2 310,00	28 NTN
4R17202	860,000	1 140,000	750,000	2 200,00	28 NTN
4R18001	900,000	1 230,000	895,000	3 250,00	28 NTN
4R1827	90,000	145,000	84,000	5,38	28 NTN







Reference	d	D	B	Kg	Brands
4R18401	920,000	1 280,000	865,000	3 560,00	28 NTN
4R20001	1 000,000	1 310,000	880,000	3 260,00	28 NTN
4R20002	1 000,000	1 360,000	800,000	3 530,00	28 NTN
4R2035	100,000	150,000	74,000	4,68	28 NTN
4R20601	1 030,000	1 380,000	850,000	3 800,00	28 NTN
4R24002	1 200,000	1 590,000	1 050,000	6 220,00	28 NTN
4R2437	120,000	180,000	92,000	8,20	28 NTN
4R2438	120,000	180,000	105,000	9,30	28 NTN
4R2628	130,000	200,000	104,000	12,10	28 NTN
4R2636	129,000	211,000	124,000	17,81	28 NTN
4R2823	140,000	210,000	116,000	13,90	28 NTN
4R2832	140,000	190,000	119,000	9,93	28 NTN
4R2904	145,000	225,000	156,000	23,30	28 NTN
4R2906	145,000	210,000	155,000	17,60	28 NTN
4R2908	145,000	225,000	156,000	23,40	28 NTN
4R3029	150,000	230,000	130,000	20,00	28 NTN
4R3031	150,000	220,000	150,000	19,40	28 NTN
4R3033K	151,500	230,000	168,000	25,40	28 NTN
4R3036	150,000	220,000	127,000	15,70	28 NTN
4R3039	150,000	250,000	150,000	29,60	28 NTN
4R3040	150,000	230,000	156,000	23,50	28 NTN
4R3042	150,000	230,000	168,000	25,80	28 NTN
4R3047	150,000	220,000	150,000	20,50	28 NTN
4R3056	150,000	220,000	150,000	19,60	28 NTN
4R3224	160,000	220,000	180,000	20,20	28 NTN
4R3225	160,000	240,000	170,000	27,80	28 NTN
4R3226	160,000	230,000	130,000	16,60	28 NTN
4R3228	160,000	230,000	180,000	25,50	28 NTN
4R3229	160,000	230,000	168,000	23,20	28 NTN
4R3231	160,000	230,000	168,000	22,90	28 NTN
4R3232	160,000	230,000	168,000	23,40	28 NTN
4R3243	160,000	230,000	168,000	26,00	28 NTN
4R3423	170,000	240,000	160,000	22,80	28 NTN
4R3425	170,000	255,000	180,000	19,30	28 NTN
4R3426	170,000	230,000	120,000	14,20	28 NTN
4R3428	170,000	250,000	168,000	28,50	28 NTN
4R3429	170,000	240,000	156,000	22,20	28 NTN
4R3431	170,000	260,000	225,000	44,00	28 NTN
4R3432	170,000	250,000	168,000	28,20	28 NTN
4R3433	170,000	260,000	150,000	29,50	28 NTN
4R3443	170,000	230,000	120,000	14,60	28 NTN
4R3618	180,000	265,000	180,000	34,20	28 NTN
4R3625	180,000	250,000	156,000	23,20	28 NTN
4R3628	180,000	260,000	168,000	26,90	28 NTN
4R3631	180,000	265,000	180,000	34,30	28 NTN
4R3639	180,000	250,000	168,000	25,60	28 NTN
4R3640	180,000	250,000	156,000	24,00	28 NTN
4R3642	180,000	260,000	168,000	28,80	28 NTN
4R3644	180,000	260,000	168,000	33,00	28 NTN
4R3817	190,000	270,000	200,000	37,20	28 NTN
4R3818	190,000	270,000	170,000	31,70	28 NTN
4R3820	190,000	260,000	168,000	26,90	28 NTN



Reference	d	D	B	Kg	Brands
4R3821	190,000	270,000	200,000	37,50	28 NTN
4R3823	190,000	280,000	200,000	41,50	28 NTN
4R3830	190,000	280,000	200,000	42,80	28 NTN
4R4026	200,000	280,000	190,000	36,70	28 NTN
4R4027	200,000	280,000	200,000	38,80	28 NTN
4R4028	200,000	320,000	216,000	67,00	28 NTN
4R4037	200,000	280,000	200,000	37,90	28 NTN
4R4039	200,000	270,000	170,000	28,50	28 NTN
4R4041	200,000	290,000	192,000	42,50	28 NTN
4R4043	200,000	290,000	192,000	46,00	28 NTN
4R4048	200,000	280,000	170,000	33,00	28 NTN
4R4050	200,000	280,000	200,000	45,00	28 NTN
4R4052	200,000	280,000	200,000	45,00	28 NTN
4R4054	200,000	280,000	152,000	29,50	28 NTN
4R4206	210,000	290,000	192,000	39,50	28 NTN
4R4410	220,000	310,000	192,000	46,30	28 NTN
4R4413	220,000	290,000	192,000	33,80	28 NTN
4R4416	220,000	310,000	225,000	54,90	28 NTN
4R4419	220,000	300,000	160,000	32,80	28 NTN
4R4420	220,000	310,000	215,000	51,50	28 NTN
4R4425	220,000	310,000	204,000	49,80	28 NTN
4R4426	220,000	310,000	192,000	46,90	28 NTN
4R4428	220,000	320,000	160,000	46,50	28 NTN
4R4429	220,000	320,000	210,000	60,50	28 NTN
4R4430	220,000	310,000	265,000	63,50	28 NTN
4R4432	220,000	310,000	192,000	45,90	28 NTN
4R4440	220,000	310,000	225,000	62,00	28 NTN
4R4444	220,000	320,000	210,000	55,40	28 NTN
4R4445	220,000	300,000	160,000	33,70	28 NTN
4R4446	220,000	300,000	160,000	41,00	28 NTN
4R4448	220,000	310,000	192,000	44,50	28 NTN
4R4449	220,000	310,000	225,000	54,30	28 NTN
4R4610	230,000	330,000	206,000	64,00	28 NTN
4R4611	230,000	340,000	260,000	82,60	28 NTN
4R4614	230,000	330,000	206,000	58,60	28 NTN
4R4617	230,000	340,000	260,000	74,30	28 NTN
4R4620	230,000	330,000	206,000	64,00	28 NTN
4R4804	240,000	330,000	220,000	57,10	28 NTN
4R4806	240,000	340,000	220,000	63,22	28 NTN
4R4807	240,000	360,000	220,000	79,60	28 NTN
4R4811	240,000	330,000	220,000	56,10	28 NTN
4R4813	240,000	360,000	220,000	80,10	28 NTN
4R4818	240,000	330,000	220,000	69,60	28 NTN
4R4819	240,000	330,000	220,000	54,10	28 NTN
4R4821	240,000	330,000	220,000	57,10	28 NTN
4R4827	240,000	330,000	180,000	46,40	28 NTN
4R5008	250,000	278,000	220,000	19,60	28 NTN
4R5208	260,000	370,000	220,000	77,10	28 NTN
4R5213	260,000	380,000	280,000	109,00	28 NTN
4R5217	260,000	370,000	220,000	76,50	28 NTN
4R5218	260,000	400,000	290,000	135,00	28 NTN
4R5221	260,000	360,000	220,000	62,70	28 NTN

Reference	d	D	B	Kg	Brands
4R5224	260,000	380,000	280,000	98,00	28 NTN
4R5231	260,000	360,000	260,000	81,50	28 NTN
4R5236	260,000	360,000	230,000	70,10	28 NTN
4R5306	265,000	370,000	234,000	78,90	28 NTN
4R5405	270,000	380,000	280,000	100,00	28 NTN
4R5407	270,000	380,000	280,000	101,00	28 NTN
4R5604	280,000	390,000	220,000	95,00	28 NTN
4R5605	280,000	420,000	280,000	139,00	28 NTN
4R5610	280,000	390,000	220,000	80,80	28 NTN
4R5611	280,000	390,000	220,000	81,30	28 NTN
4R5612	280,000	390,000	275,000	105,00	28 NTN
4R5614	280,000	350,000	208,000	46,40	28 NTN
4R5805	290,000	420,000	300,000	141,00	28 NTN
4R5806	290,000	410,000	240,000	103,00	28 NTN
4R5810	290,000	390,000	234,000	101,00	28 NTN
4R6012	300,000	420,000	240,000	103,10	28 NTN
4R6014	300,000	400,000	300,000	104,00	28 NTN
4R6015	300,000	420,000	300,000	125,00	28 NTN
4R6017	300,000	420,000	240,000	94,50	28 NTN
4R6018	300,000	420,000	320,000	136,00	28 NTN
4R6019	300,000	460,000	270,000	162,00	28 NTN
4R6020	300,000	420,000	300,000	130,00	28 NTN
4R6021	300,000	430,000	240,000	115,00	28 NTN
4R6023	300,000	420,000	240,000	105,00	28 NTN
4R6025	300,000	420,000	240,000	117,00	28 NTN
4R6027	300,000	420,000	240,000	105,00	28 NTN
4R6030	300,000	420,000	300,000	136,00	28 NTN
4R6040	300,000	420,000	300,000	129,00	28 NTN
4R6202	310,000	430,000	240,000	108,00	28 NTN
4R6406	320,000	470,000	350,000	212,00	28 NTN
4R6411	320,000	450,000	240,000	125,00	28 NTN
4R6412	320,000	460,000	340,000	178,00	28 NTN
4R6414	320,000	440,000	240,000	106,00	28 NTN
4R6602	330,000	460,000	340,000	177,00	28 NTN
4R6603	330,000	440,000	200,000	83,60	28 NTN
4R6605	330,000	460,000	340,000	181,00	28 NTN
4R6608	330,000	440,000	200,000	85,60	28 NTN
4R6804	340,000	490,000	300,000	187,00	28 NTN
4R6805	340,000	490,000	300,000	189,00	28 NTN
4R6811	340,000	480,000	370,000	198,00	28 NTN
4R6819	340,000	480,000	350,000	211,00	28 NTN
4R7105K	356,760	550,000	400,000	354,00	28 NTN
4R7108	354,600	550,000	400,000	355,00	28 NTN
4R7203	360,000	510,000	400,000	262,00	28 NTN
4R7205	360,000	510,000	400,000	251,00	28 NTN
4R7207	360,000	480,000	290,000	148,00	28 NTN
4R7212	360,000	510,000	370,000	244,00	28 NTN
4R7214	360,000	480,000	290,000	148,00	28 NTN
4R7219	360,000	500,000	250,000	146,00	28 NTN
4R7404	370,000	520,000	400,000	273,00	28 NTN
4R7405	370,000	480,000	230,000	106,00	28 NTN
4R7408	370,000	480,000	250,000	118,00	28 NTN

Reference	d	D	B	Kg	Brands
4R7411	370,000	520,000	380,000	256,00	28 NTN
4R7414	370,000	550,000	400,000	341,00	28 NTN
4R7604	380,000	540,000	400,000	325,00	28 NTN
4R7605	380,000	520,000	280,000	174,00	28 NTN
4R7607	380,000	520,000	300,000	210,00	28 NTN
4R7612	380,000	540,000	400,000	300,00	28 NTN
4R7613	380,000	540,000	400,000	298,00	28 NTN
4R7617	380,000	520,000	290,000	185,00	28 NTN
4R7618	380,000	540,000	400,000	309,00	28 NTN
4R8007	400,000	560,000	400,000	303,00	28 NTN
4R8010	400,000	560,000	410,000	349,00	28 NTN
4R8011	400,000	590,000	420,000	399,00	28 NTN
4R8401	420,000	620,000	400,000	410,00	28 NTN
4R8403	420,000	560,000	280,000	189,00	28 NTN
4R8404	420,000	580,000	230,000	181,00	28 NTN
4R8407	420,000	600,000	440,000	423,00	28 NTN
4R8605	430,000	591,000	420,000	362,00	28 NTN
4R8801	440,000	620,000	450,000	437,00	28 NTN
4R8803	440,000	620,000	450,000	450,00	28 NTN
4R8805	440,000	600,000	450,000	392,00	28 NTN
4R8806	440,000	600,000	450,000	392,00	28 NTN
4R9209	460,000	620,000	400,000	341,00	28 NTN
4R9211	460,000	620,000	400,000	383,00	28 NTN
4R9216	460,000	650,000	470,000	540,00	28 NTN
4R9223	460,000	620,000	460,000	417,00	28 NTN
4R9403	470,000	660,000	470,000	529,00	28 NTN
4R9604	480,000	680,000	500,000	640,00	28 NTN
4R9607	480,000	650,000	420,000	369,00	28 NTN
4R9610	480,000	600,000	236,000	155,00	28 NTN
4R9613	480,000	650,000	420,000	423,00	28 NTN
E-2R2114V	105,000	165,000	64,000	5,19	24 NTN
E-2R2115V	105,000	165,000	64,000	5,19	24 NTN
E-2R4703	235,000	376,000	250,000	100,80	24 NTN
E-2R5005	250,000	400,000	263,000	126,80	24 NTN
E-2R5614	280,000	450,000	320,000	149,00	24 NTN
E-2R6018	300,000	466,000	370,000	221,10	24 NTN
E-2R6805	340,000	440,000	143,000	49,60	24 NTN
E-2R7615	380,000	657,000	410,000	600,00	24 NTN
E-4R10006	500,000	690,000	510,000	640,00	28 NTN
E-4R10008	500,000	710,000	480,000	675,00	28 NTN
E-4R10010	500,000	680,000	420,000	495,00	28 NTN
E-4R10011	500,000	700,000	515,000	680,00	28 NTN
E-4R10015	500,000	720,000	530,000	780,00	28 NTN
E-4R10016	500,000	690,000	470,000	590,00	28 NTN
E-4R10201	510,000	670,000	320,000	335,00	28 NTN
E-4R10202	510,000	700,000	540,000	689,00	28 NTN
E-4R10402	520,000	735,000	535,000	740,00	28 NTN
E-4R10403	520,000	700,000	540,000	658,00	28 NTN
E-4R10601	530,000	760,000	520,000	800,00	28 NTN
E-4R10602	530,000	780,000	570,000	1 010,00	28 NTN
E-4R10603	530,000	700,000	540,000	626,00	28 NTN
E-4R11001	550,000	800,000	520,000	965,00	28 NTN



					Brands	
Reference	d	D	B	Kg		
E-4R11202	560,000	680,000	360,000	265,00	28	NTN
E-4R11402	570,000	815,000	594,000	1 040,00	28	NTN
E-4R12001	600,000	870,000	640,000	1 330,00	28	NTN
E-4R12002	600,000	870,000	540,000	1 150,00	28	NTN
E-4R12003	600,000	820,000	575,000	980,00	28	NTN
E-4R12202	610,000	870,000	660,000	1 400,00	28	NTN
E-4R13003	650,000	920,000	690,000	1 550,00	28	NTN
E-4R13005	650,000	920,000	670,000	1 500,00	28	NTN
E-4R13201	660,000	820,000	440,000	580,00	28	NTN
E-4R13802	690,000	980,000	715,000	1 850,00	28	NTN
E-4R14003	700,000	930,000	620,000	1 200,00	28	NTN
E-4R14205	710,000	1 000,000	715,000	1 900,00	28	NTN
E-4R14501	725,000	1 000,000	700,000	1 730,00	28	NTN
E-4R15001	750,000	1 050,000	745,000	2 180,00	28	NTN
E-4R15002	750,000	1 090,000	745,000	2 530,00	28	NTN
E-4R15203	760,000	1 100,000	745,000	2 560,00	28	NTN
E-4R15204	760,000	1 030,000	750,000	2 000,00	28	NTN
E-4R15207	760,000	1 080,000	805,000	2 550,00	28	NTN
E-4R16004	800,000	1 080,000	700,000	1 950,00	28	NTN
E-4R16005	800,000	1 080,000	750,000	2 090,00	28	NTN
E-4R16403	820,000	1 160,000	840,000	2 930,00	28	NTN
E-4R16405	820,000	1 130,000	825,000	2 520,00	28	NTN
E-4R16406	820,000	1 130,000	800,000	2 450,00	28	NTN
E-4R16801	840,000	1 160,000	840,000	2 840,00	28	NTN
E-4R17001	850,000	1 150,000	650,000	1 980,00	28	NTN
E-4R17002	850,000	1 180,000	850,000	2 970,00	28	NTN
E-4R17003	850,000	1 150,000	800,000	2 430,00	28	NTN
E-4R17004	850,000	1 180,000	650,000	2 270,00	28	NTN
E-4R17201	860,000	1 160,000	735,000	2 310,00	28	NTN
E-4R18001	900,000	1 230,000	895,000	3 250,00	28	NTN
E-4R18401	920,000	1 280,000	865,000	3 560,00	28	NTN
E-4R20001	1 000,000	1 310,000	880,000	3 260,00	28	NTN
E-4R20002	1 000,000	1 360,000	800,000	3 530,00	28	NTN
E-4R20601	1 030,000	1 380,000	850,000	3 800,00	28	NTN
E-4R24002	1 200,000	1 590,000	1 050,000	6 220,00	28	NTN
E-4R6014	300,000	400,000	300,000	104,00	28	NTN
E-4R6015	300,000	420,000	300,000	125,00	28	NTN
E-4R6017	300,000	420,000	240,000	106,00	28	NTN
E-4R6018	300,000	420,000	320,000	136,00	28	NTN
E-4R6019	300,000	460,000	270,000	162,00	28	NTN
E-4R6020	300,000	420,000	300,000	130,00	28	NTN
E-4R6202	310,000	430,000	240,000	108,00	28	NTN
E-4R6406	320,000	470,000	350,000	212,00	28	NTN
E-4R6411	320,000	450,000	240,000	125,00	28	NTN
E-4R6412	320,000	460,000	340,000	178,00	28	NTN
E-4R6414	320,000	440,000	240,000	106,00	28	NTN
E-4R6603	330,000	440,000	200,000	83,60	28	NTN
E-4R6605	330,000	460,000	340,000	181,00	28	NTN
E-4R6804	340,000	490,000	300,000	187,00	28	NTN
E-4R6811	340,000	480,000	370,000	198,00	28	NTN
E-4R7203	360,000	510,000	400,000	262,00	28	NTN
E-4R7404	370,000	520,000	400,000	273,00	28	NTN

					Brands	
Reference	d	D	B	Kg		
E-4R7405	370,000	480,000	230,000	106,00	28	NTN
E-4R7604	380,000	540,000	400,000	325,00	28	NTN
E-4R7605	380,000	520,000	280,000	174,00	28	NTN
E-4R7607	380,000	520,000	300,000	210,00	28	NTN
E-4R8007	400,000	560,000	400,000	303,00	28	NTN
E-4R8010	400,000	560,000	410,000	349,00	28	NTN
E-4R8201	410,000	546,000	400,000	256,00	28	NTN
E-4R8401	420,000	620,000	400,000	410,00	28	NTN
E-4R8403	420,000	560,000	280,000	189,00	28	NTN
E-4R8404	420,000	580,000	230,000	181,00	28	NTN
E-4R8801	440,000	620,000	450,000	437,00	28	NTN
E-4R9209	460,000	620,000	400,000	341,00	28	NTN
E-4R9211	460,000	620,000	400,000	383,00	28	NTN
E-4R9216	460,000	650,000	470,000	540,00	28	NTN
E-4R9604	480,000	680,000	500,000	640,00	28	NTN
E-4R9607	480,000	650,000	420,000	369,00	28	NTN
E-4R9609	480,000	650,000	450,000	395,00	28	NTN
E-NF309	45,000	100,000	25,000	0,89	22	NTN
E-NFV311	55,000	120,000	29,000	1,60	22	NTN
E-NFV312	60,000	130,000	31,000	1,96	22	NTN
E-NJ2311EHTG1	55,000	120,000	43,000	2,37	18	NTN
E-NJ2328E	140,000	300,000	102,000	36,40	18	NTN
E-NJ312E	60,000	130,000	31,000	1,96	18	NTN
E-NJ318AG1	90,000	190,000	43,000	5,74	18	NTN
E-NJK309	45,000	100,000	25,000	0,97	18	NTN
E-NU1992	460,000	620,000	74,000	65,20	17	NTN
E-NU2334BG1	170,000	360,000	120,000	58,70	17	NTN
E-NU319E	95,000	200,000	45,000	6,62	17	NTN
E-NUP2334BG1	170,000	360,000	120,000	70,80	19	NTN
E-R0697V	30,000	80,000	21,000	0,56	17	NTN
E-R06A92	32,000	65,000	28,000	0,36	17	NTN
E-R0725V	35,000	72,000	20,600	0,40	17	NTN
E-R08A67	38,000	70,000	40,000	0,59	17	NTN
E-R08A68	38,000	70,000	40,000	0,59	17	NTN
E-R0949	45,000	86,060	25,000	0,61	17	NTN
ER10406V	520,000	735,000	390,000	422,00	17	NTN
E-R1050	50,000	94,442	27,000	0,74	17	NTN
E-R1230	60,543	90,041	20,000	0,38	17	NTN
E-R1745	83,779	140,050	33,000	1,93	17	NTN
E-R1939	95,000	122,984	18,000	0,47	17	NTN
E-RNF0820N	38,000	83,000	25,400	0,96	22	NTN
E-RNF1218	60,000	110,000	25,000	1,67	22	NTN
E-RNF16801	838,200	1 041,400	88,900	182,00	22	NTN
E-RNF17301	863,600	1 066,800	146,050	309,00	22	NTN
E-RNJ3849	190,000	400,000	105,000	33,04	18	NTN
E-RNJ4022	200,000	290,000	55,000	11,80	18	NTN
E-RNNU8013	400,000	570,000	250,000	214,00	24	NTN
E-RNU25201	1 260,000	1 580,000	335,000	1 580,00	17	NTN
E-RNU7204	359,845	540,000	180,000	146,50	17	NTN
E-RNUP1415	70,000	140,000	33,000	2,44	19	NTN
E-RNUP1732	85,000	140,000	33,000	0,000	19	NTN
E-RR1313	64,981	90,700	33,000	0,59	24	NTN

Reference	d	D	B	Kg	?	Brands
E-RR1610	81,480	107,950	25,000	0,45	24	NTN
E-RR2035	101,240	120,050	23,000	0,46	24	NTN
E-RR2109	103,652	120,000	29,000	0,63	24	NTN
E-RR2232	109,100	125,058	22,000	0,41	24	NTN
E-SL30X210X132ZZ	130,000	210,000	132,000	20,00	26	NTN
E-SL30X210X150	130,000	210,000	150,000	22,00	26	NTN
E-SL40X210X130	140,000	210,000	130,000	21,00	26	NTN
E-SLX130X210X132	130,000	210,000	132,000	20,00	26	NTN
E-SLX130X210X132ZZ	130,000	210,000	132,000	20,00	26	NTN
E-SLX130X210X150	130,000	210,000	150,000	22,00	26	NTN
E-SLX140X210X130	140,000	210,000	130,000	21,00	26	NTN
F-NU1080	400,000	600,000	90,000	87,60	17	NTN
F-NU1956	280,000	380,000	46,000	14,55	17	NTN
N10/500	500,000	720,000	100,000	128,00	20	NTN
N1005	25,000	47,000	12,000	0,09	20	NTN
N1006	30,000	55,000	13,000	0,13	20	NTN
N1007	35,000	62,000	14,000	0,18	20	NTN
N1008	40,000	68,000	15,000	0,22	20	NTN
N1009	45,000	75,000	16,000	0,28	20	NTN
N1010	50,000	80,000	16,000	0,29	20	NTN
N1011	55,000	90,000	18,000	0,41	20	NTN
N1012	60,000	95,000	18,000	0,47	20	NTN
N1013	65,000	100,000	18,000	0,48	20	NTN
N1014	70,000	110,000	20,000	0,69	20	NTN
N1015	75,000	115,000	20,000	0,73	20	NTN
N1016	80,000	125,000	22,000	0,97	20	NTN
N1017	85,000	130,000	22,000	1,01	20	NTN
N1018	90,000	140,000	24,000	1,33	20	NTN
N1019	95,000	145,000	24,000	1,38	20	NTN
N1020	100,000	150,000	24,000	1,43	20	NTN
N1021	105,000	160,000	26,000	1,83	20	NTN
N1022	110,000	170,000	28,000	2,30	20	NTN
N1024	120,000	180,000	28,000	2,40	20	NTN
N1026	130,000	200,000	33,000	3,49	20	NTN
N1028	140,000	210,000	33,000	3,98	20	NTN
N1028K	140,000	210,000	33,000	4,12	20	NTN
N1030	150,000	225,000	35,000	4,70	20	NTN
N1032	160,000	240,000	38,000	5,81	20	NTN
N1034	170,000	260,000	42,000	7,02	20	NTN
N1036	180,000	280,000	46,000	10,10	20	NTN
N1038	190,000	290,000	46,000	10,50	20	NTN
N1040	200,000	310,000	51,000	13,70	20	NTN
N1040K	200,000	310,000	51,000	13,33	20	NTN
N1044	220,000	340,000	56,000	18,10	20	NTN
N1044K	220,000	340,000	56,000	17,90	20	NTN
N1048	240,000	360,000	56,000	19,50	20	NTN
N1052	260,000	400,000	65,000	28,70	20	NTN
N1056	280,000	420,000	65,000	30,40	20	NTN
N1060	300,000	460,000	74,000	42,90	20	NTN
N1064	320,000	480,000	74,000	45,30	20	NTN
N1068	340,000	520,000	82,000	60,50	20	NTN
N1072	360,000	540,000	82,000	63,70	20	NTN

Reference	d	D	B	Kg	?	Brands
N1076	380,000	560,000	82,000	66,10	20	NTN
N1080	400,000	600,000	90,000	86,30	20	NTN
N1084	420,000	620,000	90,000	89,60	20	NTN
N1088	440,000	650,000	94,000	103,00	20	NTN
N1092	460,000	680,000	100,000	120,00	20	NTN
N1096	480,000	700,000	100,000	124,00	20	NTN
N1940K	200,000	280,000	38,000	6,76	20	NTN
N1952K	260,000	360,000	46,000	14,10	20	NTN
N1984K	420,000	560,000	65,000	44,00	20	NTN
N203	17,000	40,000	12,000	0,07	20	NTN
N204	20,000	47,000	14,000	0,11	20	NTN
N204E	20,000	47,000	14,000	0,11	20	NTN
N 204 EG15	20,000	47,000	14,000	0,12	20	SNR
N205	25,000	52,000	15,000	0,13	20	NTN
N205E	25,000	52,000	15,000	0,13	20	NTN
N 205 EG15	25,000	52,000	15,000	0,14	20	SNR
N206	30,000	62,000	16,000	0,20	20	NTN
N206E	30,000	62,000	16,000	0,20	20	NTN
N 206 EG15	30,000	62,000	16,000	0,27	20	SNR
N207	35,000	72,000	17,000	0,29	20	NTN
N207E	35,000	72,000	17,000	0,29	20	NTN
N 207 EG15	35,000	72,000	17,000	0,30	20	SNR
N208	40,000	80,000	18,000	0,37	20	NTN
N208E	40,000	80,000	18,000	0,37	20	NTN
N 208 EG15	40,000	80,000	18,000	0,38	20	SNR
N209	45,000	85,000	19,000	0,42	20	NTN
N209E	45,000	85,000	19,000	0,42	20	NTN
N 209 EG15	45,000	85,000	19,000	0,45	20	SNR
N210	50,000	90,000	20,000	0,48	20	NTN
N210E	50,000	90,000	20,000	0,48	20	NTN
N 210 EG15	50,000	90,000	20,000	0,49	20	SNR
N211	55,000	100,000	21,000	0,63	20	NTN
N211E	55,000	100,000	21,000	0,63	20	NTN
N 211 EG15	55,000	100,000	21,000	0,67	20	SNR
N212	60,000	110,000	22,000	0,81	20	NTN
N212E	60,000	110,000	22,000	0,81	20	NTN
N 212 EG15	60,000	110,000	22,000	0,83	20	SNR
N213	65,000	120,000	23,000	1,04	20	NTN
N213E	65,000	120,000	23,000	1,04	20	NTN
N 213 EG15	65,000	120,000	23,000	1,05	20	SNR
N214	70,000	125,000	24,000	1,20	20	NTN
N214E	70,000	125,000	24,000	1,10	20	NTN
N 214 EG15	70,000	125,000	24,000	1,16	20	SNR
N215	75,000	130,000	25,000	1,21	20	NTN
N215E	75,000	130,000	25,000	1,21	20	NTN
N 215 EG15	75,000	130,000	25,000	1,28	20	SNR
N216	80,000	140,000	26,000	1,47	20	NTN
N 216 EG15	80,000	140,000	26,000	1,54	20	SNR
N217	85,000	150,000	28,000	1,98	20	NTN
N 217 EG15	85,000	150,000	28,000	1,91	20	SNR
N218	90,000	160,000	30,000	2,25	20	NTN
N 218 EG15	90,000	160,000	30,000	2,35	20	SNR



Reference	d	D	B	Kg		Brands
N219	95,000	170,000	32,000	2,91	20	NTN
N 219 EG15	95,000	170,000	32,000	2,83	20	SNR
N220	100,000	180,000	34,000	3,26	20	NTN
N2208	40,000	80,000	23,000	0,48	20	NTN
N2209	45,000	85,000	23,000	0,52	20	NTN
N220E	100,000	180,000	34,000	3,34	20	NTN
N 220 EG15	100,000	180,000	34,000	3,46	20	SNR
N221	105,000	190,000	36,000	3,95	20	NTN
N2210	50,000	90,000	23,000	0,56	20	NTN
N2211	55,000	100,000	25,000	0,76	20	NTN
N2211E	55,000	100,000	25,000	0,76	20	NTN
N2212	60,000	110,000	28,000	1,04	20	NTN
N2212E	60,000	110,000	28,000	1,04	20	NTN
N2213	65,000	120,000	31,000	1,37	20	NTN
N2214	70,000	125,000	31,000	1,44	20	NTN
N2215	75,000	130,000	31,000	1,63	20	NTN
N2216	80,000	140,000	33,000	1,89	20	NTN
N2217	85,000	150,000	36,000	2,39	20	NTN
N2218	90,000	160,000	40,000	3,04	20	NTN
N2219	95,000	170,000	43,000	3,71	20	NTN
N222	110,000	200,000	38,000	4,64	20	NTN
N2220	100,000	180,000	46,000	4,48	20	NTN
N2222	110,000	200,000	53,000	6,43	20	NTN
N2224	120,000	215,000	58,000	8,03	20	NTN
N2226	130,000	230,000	64,000	10,00	20	NTN
N2228	140,000	250,000	68,000	12,60	20	NTN
N222E	110,000	200,000	38,000	4,64	20	NTN
N 222 EM	110,000	200,000	38,000	5,49	20	SNR
N2230	150,000	270,000	73,000	16,00	20	NTN
N2232	160,000	290,000	80,000	21,60	20	NTN
N2234	170,000	310,000	86,000	26,70	20	NTN
N2236	180,000	320,000	86,000	27,80	20	NTN
N2238	190,000	340,000	92,000	33,70	20	NTN
N224	120,000	215,000	40,000	5,46	20	NTN
N2240	200,000	360,000	98,000	40,50	20	NTN
N2244	220,000	400,000	108,000	57,80	20	NTN
N2248	240,000	440,000	120,000	78,40	20	NTN
N2252	260,000	480,000	130,000	102,00	20	NTN
N2256	280,000	500,000	130,000	107,00	20	NTN
N226	130,000	230,000	40,000	6,42	20	NTN
N2260	300,000	540,000	140,000	135,00	20	NTN
N2264	320,000	580,000	150,000	168,00	20	NTN
N228	140,000	250,000	42,000	8,56	20	NTN
N 228 EM	140,000	250,000	42,000	9,34	20	SNR
N230	150,000	270,000	45,000	9,72	20	NTN
N2308	40,000	90,000	33,000	0,93	20	NTN
N2309	45,000	100,000	36,000	1,24	20	NTN
N2310	50,000	110,000	40,000	1,67	20	NTN
N2311	55,000	120,000	43,000	2,13	20	NTN
N2312	60,000	130,000	46,000	2,66	20	NTN
N2313	65,000	140,000	48,000	3,20	20	NTN
N2314	70,000	150,000	51,000	3,90	20	NTN

Reference	d	D	B	Kg		Brands
N2315	75,000	160,000	55,000	4,77	20	NTN
N2316	80,000	170,000	58,000	5,67	20	NTN
N2317	85,000	180,000	60,000	6,57	20	NTN
N2318	90,000	190,000	64,000	7,79	20	NTN
N2319	95,000	200,000	67,000	9,02	20	NTN
N232	160,000	290,000	48,000	13,40	20	NTN
N2320	100,000	215,000	73,000	11,50	20	NTN
N2322	110,000	240,000	80,000	16,80	20	NTN
N2324	120,000	260,000	86,000	21,10	20	NTN
N2326	130,000	280,000	93,000	26,40	20	NTN
N2328	140,000	300,000	102,000	33,10	20	NTN
N2330	150,000	320,000	108,000	39,80	20	NTN
N2332	160,000	340,000	114,000	49,50	20	NTN
N2334	170,000	360,000	120,000	58,30	20	NTN
N2336	180,000	380,000	126,000	68,10	20	NTN
N2338	190,000	400,000	132,000	78,90	20	NTN
N234	170,000	310,000	52,000	16,70	20	NTN
N2340	200,000	420,000	138,000	90,70	20	NTN
N2344	220,000	460,000	145,000	114,00	20	NTN
N2348	240,000	500,000	155,000	144,00	20	NTN
N2352	260,000	540,000	165,000	178,00	20	NTN
N2356	280,000	580,000	175,000	218,00	20	NTN
N236	180,000	320,000	52,000	17,30	20	NTN
N238	190,000	340,000	55,000	21,13	20	NTN
N240	200,000	360,000	58,000	25,10	20	NTN
N244	220,000	400,000	65,000	36,50	20	NTN
N248	240,000	440,000	72,000	49,20	20	NTN
N252	260,000	480,000	80,000	65,60	20	NTN
N256	280,000	500,000	80,000	69,40	20	NTN
N260	300,000	540,000	85,000	86,40	20	NTN
N264	320,000	580,000	92,000	109,00	20	NTN
N268	340,000	620,000	224,000	316,00	20	NTN
N272	360,000	650,000	232,000	369,00	20	NTN
N276	380,000	680,000	240,000	400,00	20	NTN
N29/600	600,000	800,000	118,000	170,00	20	NTN
N2948	240,000	320,000	48,000	9,44	20	NTN
N3038	190,000	290,000	75,000	18,00	20	NTN
N304E	20,000	52,000	15,000	0,15	20	NTN
N 304 EG15	20,000	52,000	15,000	0,15	20	SNR
N305	25,000	62,000	17,000	0,23	20	NTN
N305E	25,000	62,000	17,000	0,23	20	NTN
N 305 EG15	25,000	62,000	17,000	0,24	20	SNR
N306	30,000	72,000	19,000	0,35	20	NTN
N306E	30,000	72,000	19,000	0,35	20	NTN
N 306 EG15	30,000	72,000	19,000	0,37	20	SNR
N307	35,000	80,000	21,000	0,47	20	NTN
N307E	35,000	80,000	21,000	0,51	20	NTN
N 307 EG15	35,000	80,000	21,000	0,48	20	SNR
N308	40,000	90,000	23,000	0,64	20	NTN
N308E	40,000	90,000	23,000	0,64	20	NTN
N 308 EG15	40,000	90,000	23,000	0,65	20	SNR
N309	45,000	100,000	25,000	0,86	20	NTN

Reference	d	D	B	Kg		Brands
N309E	45,000	100,000	25,000	0,86	20	NTN
N 309 EG15	45,000	100,000	25,000	0,88	20	SNR
N310	50,000	110,000	27,000	1,11	20	NTN
N310E	50,000	110,000	27,000	1,11	20	NTN
N 310 EG15	50,000	110,000	27,000	1,15	20	SNR
N311	55,000	120,000	29,000	1,41	20	NTN
N311E	55,000	120,000	29,000	1,41	20	NTN
N 311 EG15	55,000	120,000	29,000	1,47	20	SNR
N312	60,000	130,000	31,000	1,76	20	NTN
N312E	60,000	130,000	31,000	1,76	20	NTN
N 312 EG15	60,000	130,000	31,000	1,81	20	SNR
N313	65,000	140,000	33,000	2,18	20	NTN
N313E	65,000	140,000	33,000	2,18	20	NTN
N 313 EG15	65,000	140,000	33,000	2,24	20	SNR
N314	70,000	150,000	35,000	2,65	20	NTN
N 314 EG15	70,000	150,000	35,000	2,80	20	SNR
N315	75,000	160,000	37,000	3,22	20	NTN
N 315 EG15	75,000	160,000	37,000	3,70	20	SNR
N316	80,000	170,000	39,000	3,77	20	NTN
N316E	80,000	170,000	39,000	3,77	20	NTN
N 316 EG15	80,000	170,000	39,000	3,93	20	SNR
N317	85,000	180,000	41,000	4,44	20	NTN
N317E	85,000	180,000	41,000	4,44	20	NTN
N 317 EM	85,000	180,000	41,000	5,33	20	SNR
N318	90,000	190,000	43,000	5,18	20	NTN
N318E	90,000	190,000	43,000	5,18	20	NTN
N 318 EM	90,000	190,000	43,000	6,21	20	SNR
N319	95,000	200,000	45,000	6,47	20	NTN
N319E	95,000	200,000	45,000	5,99	20	NTN
N 319 EM	95,000	200,000	45,000	6,97	20	SNR
N320	100,000	215,000	47,000	7,56	20	NTN
N320E	100,000	215,000	47,000	7,56	20	NTN
N 320 EM	100,000	215,000	47,000	8,78	20	SNR
N321	105,000	225,000	49,000	8,33	20	NTN
N3211	55,000	100,000	33,300	1,02	20	NTN
N322	110,000	240,000	50,000	9,77	20	NTN
N322E	110,000	240,000	50,000	9,98	20	NTN
N 322 EM	110,000	240,000	50,000	10,60	20	SNR
N324	120,000	260,000	55,000	13,90	20	NTN
N 324 EM	120,000	260,000	55,000	14,94	20	SNR
N326	130,000	280,000	58,000	17,00	20	NTN
N 326 EM	130,000	280,000	58,000	18,44	20	SNR
N328	140,000	300,000	62,000	20,80	20	NTN
N 328 EM	140,000	300,000	62,000	22,65	20	SNR
N330	150,000	320,000	65,000	24,70	20	NTN
N 330 EM	150,000	320,000	65,000	27,57	20	SNR
N332	160,000	340,000	68,000	30,60	20	NTN
N334	170,000	360,000	72,000	36,10	20	NTN
N 334 EM	170,000	360,000	72,000	37,90	20	SNR
N336	180,000	380,000	75,000	42,74	20	NTN
N338	190,000	400,000	78,000	48,30	20	NTN
N 338 EM	190,000	400,000	78,000	50,50	20	SNR

Reference	d	D	B	Kg		Brands
N340	200,000	420,000	80,000	54,50	20	NTN
N 340 EM	200,000	420,000	80,000	57,00	20	SNR
N344	220,000	460,000	88,000	71,70	20	NTN
N348	240,000	500,000	95,000	91,30	20	NTN
N352	260,000	540,000	102,000	114,00	20	NTN
N356	280,000	580,000	108,000	139,00	20	NTN
N405	25,000	80,000	21,000	0,54	20	NTN
N406	30,000	90,000	23,000	0,73	20	NTN
N407	35,000	100,000	25,000	0,98	20	NTN
N408	40,000	110,000	27,000	1,27	20	NTN
N409	45,000	120,000	29,000	1,58	20	NTN
N410	50,000	130,000	31,000	1,97	20	NTN
N411	55,000	140,000	33,000	2,42	20	NTN
N412	60,000	150,000	35,000	2,93	20	NTN
N413	65,000	160,000	37,000	3,50	20	NTN
N414	70,000	180,000	42,000	5,15	20	NTN
N415	75,000	190,000	45,000	6,06	20	NTN
N416	80,000	200,000	48,000	7,17	20	NTN
N417	85,000	210,000	52,000	9,20	20	NTN
N418	90,000	225,000	54,000	11,00	20	NTN
N421	105,000	260,000	60,000	16,00	20	NTN
N428	140,000	360,000	82,000	44,50	20	NTN
NF1021	105,000	160,000	26,000	1,89	22	NTN
NF18/500	500,000	620,000	56,000	37,68	22	NTN
NF19/630	630,000	850,000	100,000	166,00	22	NTN
NF1952	260,000	360,000	46,000	14,18	22	NTN
NF1996	480,000	650,000	78,000	78,16	22	NTN
NF203	17,000	40,000	12,000	0,07	22	NTN
NF204	20,000	47,000	14,000	0,11	22	NTN
NF204E	20,000	47,000	14,000	0,11	22	NTN
NF205	25,000	52,000	15,000	0,14	22	NTN
NF205E	25,000	52,000	15,000	0,13	22	NTN
NF206	30,000	62,000	16,000	0,21	22	NTN
NF206E	30,000	62,000	16,000	0,21	22	NTN
NF207	35,000	72,000	17,000	0,30	22	NTN
NF207E	35,000	72,000	17,000	0,49	22	NTN
NF208	40,000	80,000	18,000	0,38	22	NTN
NF208E	40,000	80,000	18,000	0,42	22	NTN
NF209	45,000	85,000	19,000	0,44	22	NTN
NF209E	45,000	85,000	19,000	0,44	22	NTN
NF210	50,000	90,000	20,000	0,50	22	NTN
NF210E	50,000	90,000	20,000	0,50	22	NTN
NF211	55,000	100,000	21,000	0,65	22	NTN
NF211E	55,000	100,000	21,000	0,65	22	NTN
NF212	60,000	110,000	22,000	0,80	22	NTN
NF212E	60,000	110,000	22,000	0,80	22	NTN
NF213	65,000	120,000	23,000	1,08	22	NTN
NF213E	65,000	120,000	23,000	1,08	22	NTN
NF214	70,000	125,000	24,000	1,17	22	NTN
NF214E	70,000	125,000	24,000	1,17	22	NTN
NF215	75,000	130,000	25,000	1,26	22	NTN
NF215E	75,000	130,000	25,000	1,30	22	NTN



Reference	d	D	B	Kg	?	Brands
NF215E/60	60,000	130,000	25,000	1,62	22	NTN
NF216	80,000	140,000	26,000	1,51	22	NTN
NF217	85,000	150,000	28,000	1,85	22	NTN
NF218	90,000	160,000	30,000	2,36	22	NTN
NF219	95,000	170,000	32,000	2,85	22	NTN
NF220	100,000	180,000	34,000	3,43	22	NTN
NF2204	20,000	47,000	18,000	0,14	22	NTN
NF2205	25,000	52,000	18,000	0,17	22	NTN
NF221	105,000	190,000	36,000	4,08	22	NTN
NF2213	65,000	120,000	31,000	1,54	22	NTN
NF222	110,000	200,000	38,000	5,05	22	NTN
NF224	120,000	215,000	40,000	5,78	22	NTN
NF226	130,000	230,000	40,000	6,96	22	NTN
NF230	150,000	270,000	45,000	11,10	22	NTN
NF2305E	25,000	62,000	24,000	0,34	22	NTN
NF2306	30,000	72,000	27,000	0,55	22	NTN
NF2312	60,000	130,000	46,000	2,70	22	NTN
NF2316	80,000	170,000	58,000	5,95	22	NTN
NF232	160,000	290,000	48,000	13,80	22	NTN
NF234	170,000	310,000	52,000	17,20	22	NTN
NF236	180,000	320,000	52,000	17,10	22	NTN
NF238	190,000	340,000	55,000	21,70	22	NTN
NF2976	380,000	520,000	82,000	55,00	22	NTN
NF2988	440,000	600,000	95,000	82,80	22	NTN
NF304	20,000	52,000	15,000	0,15	22	NTN
NF304E	20,000	52,000	15,000	0,15	22	NTN
NF305	25,000	62,000	17,000	0,24	22	NTN
NF305E	25,000	62,000	17,000	0,24	22	NTN
NF306	30,000	72,000	19,000	0,36	22	NTN
NF306E	30,000	72,000	19,000	0,36	22	NTN
NF307	35,000	80,000	21,000	0,49	22	NTN
NF307E	35,000	80,000	21,000	0,49	22	NTN
NF308	40,000	90,000	23,000	0,67	22	NTN
NF308E	40,000	90,000	23,000	0,67	22	NTN
NF309	45,000	100,000	25,000	0,89	22	NTN
NF309E	45,000	100,000	25,000	0,89	22	NTN
NF310	50,000	110,000	27,000	1,15	22	NTN
NF310E	50,000	110,000	27,000	1,15	22	NTN
NF311	55,000	120,000	29,000	1,46	22	NTN
NF311E	55,000	120,000	29,000	1,46	22	NTN
NF312	60,000	130,000	31,000	1,81	22	NTN
NF312E	60,000	130,000	31,000	1,81	22	NTN
NF313	65,000	140,000	33,000	2,23	22	NTN
NF313E	65,000	140,000	33,000	2,23	22	NTN
NF314	70,000	150,000	35,000	2,76	22	NTN
NF314E	70,000	150,000	35,000	2,76	22	NTN
NF315	75,000	160,000	37,000	3,53	22	NTN
NF316	80,000	170,000	39,000	3,96	22	NTN
NF317	85,000	180,000	41,000	4,92	22	NTN
NF318	90,000	190,000	43,000	5,41	22	NTN
NF319	95,000	200,000	45,000	6,68	22	NTN
NF320	100,000	215,000	47,000	7,79	22	NTN

Reference	d	D	B	Kg	?	Brands
NF321	105,000	225,000	49,000	9,44	22	NTN
NF322	110,000	240,000	50,000	10,60	22	NTN
NF324	120,000	260,000	55,000	14,20	22	NTN
NF326	130,000	280,000	58,000	17,36	22	NTN
NF328	140,000	300,000	62,000	21,40	22	NTN
NF330	150,000	320,000	65,000	25,50	22	NTN
NF332	160,000	340,000	68,000	31,10	22	NTN
NF334	170,000	360,000	72,000	31,30	22	NTN
NF338	190,000	400,000	78,000	49,60	22	NTN
NF340	200,000	420,000	80,000	56,14	22	NTN
NF405	25,000	80,000	21,000	0,57	22	NTN
NF406	30,000	90,000	23,000	0,76	22	NTN
NF408	40,000	110,000	27,000	1,22	22	NTN
NF412	60,000	150,000	35,000	3,03	22	NTN
NF413	65,000	160,000	37,000	3,62	22	NTN
NF414	70,000	180,000	42,000	5,65	22	NTN
NF416	80,000	200,000	48,000	6,97	22	NTN
NF417	85,000	210,000	52,000	9,25	22	NTN
NF418	90,000	225,000	54,000	11,30	22	NTN
NFV18/530	530,000	650,000	56,000	37,70	22	NTN
NFV18/630	630,000	780,000	69,000	72,80	22	NTN
NFV18/670	670,000	820,000	69,000	75,00	22	NTN
NFV1838	190,000	240,000	24,000	2,54	22	NTN
NFV1848	240,000	300,000	28,000	4,49	22	NTN
NFV1884	420,000	520,000	46,000	20,90	22	NTN
NFV1888	440,000	540,000	46,000	22,20	22	NTN
NFV1892	460,000	580,000	56,000	34,90	22	NTN
NFV19/560	560,000	750,000	85,000	112,00	22	NTN
NFV209	45,000	85,000	19,000	0,46	22	NTN
NFV2205	25,000	52,000	18,000	0,18	22	NTN
NFV2206	30,000	62,000	20,000	0,28	22	NTN
NFV28/800	800,000	980,000	106,000	169,00	22	NTN
NFV29/600	600,000	800,000	118,000	165,00	22	NTN
NFV2944	220,000	300,000	48,000	10,00	22	NTN
NFV2956	280,000	380,000	60,000	20,00	22	NTN
NFV3020A	100,000	150,000	37,000	2,28	22	NTN
NFV3036A	180,000	280,000	74,000	16,80	22	NTN
NFV307	35,000	80,000	21,000	0,56	22	NTN
NH205	25,000	52,000	18,000	0,16	21	NTN
NH218	90,000	160,000	39,000	2,92	21	NTN
NH224	120,000	215,000	51,000	6,91	21	NTN
NH230	150,000	270,000	57,000	12,29	21	NTN
NH2312	60,000	130,000	55,000	3,13	21	NTN
NH232	160,000	290,000	60,000	15,43	21	NTN
NH308	40,000	90,000	30,000	0,84	21	NTN
NH309	45,000	100,000	32,000	1,09	21	NTN
NH312	60,000	130,000	40,000	2,28	21	NTN
NH312E	60,000	130,000	40,000	2,17	21	NTN
NH315	75,000	160,000	48,000	4,06	21	NTN
NH316	80,000	170,000	50,000	4,86	21	NTN
NH317	85,000	180,000	53,000	5,76	21	NTN
NH320	100,000	215,000	60,000	9,21	21	NTN

Reference	d	D	B	Kg	?	Brands
NH324	120,000	260,000	69,000	15,70	21	NTN
NH332	160,000	340,000	83,000	32,30	21	NTN
NH344	220,000	460,000	108,000	81,10	21	NTN
NH412	60,000	150,000	45,000	3,53	21	NTN
NH414	70,000	180,000	54,000	5,97	21	NTN
NH417	85,000	210,000	66,000	10,42	21	NTN
NH418	90,000	225,000	68,000	12,37	21	NTN
NH419	95,000	240,000	70,000	14,80	21	NTN
NH420	100,000	250,000	74,000	17,00	21	NTN
NH428	140,000	360,000	100,000	50,05	21	NTN
NJ10/500	500,000	720,000	100,000	130,00	18	NTN
NJ1005	25,000	47,000	12,000	0,09	18	NTN
NJ1006	30,000	55,000	13,000	0,13	18	NTN
NJ1007	35,000	62,000	14,000	0,18	18	NTN
NJ1008	40,000	68,000	15,000	0,21	18	NTN
NJ1009	45,000	75,000	16,000	0,28	18	NTN
NJ1010	50,000	80,000	16,000	0,30	18	NTN
NJ1011	55,000	90,000	18,000	0,44	18	NTN
NJ1012	60,000	95,000	18,000	0,47	18	NTN
NJ1013	65,000	100,000	18,000	0,49	18	NTN
NJ1014	70,000	110,000	20,000	0,70	18	NTN
NJ1015	75,000	115,000	20,000	0,72	18	NTN
NJ1016	80,000	125,000	22,000	0,98	18	NTN
NJ1017	85,000	130,000	22,000	1,03	18	NTN
NJ1018	90,000	140,000	24,000	1,33	18	NTN
NJ1019	95,000	145,000	24,000	1,37	18	NTN
NJ1020	100,000	150,000	24,000	1,45	18	NTN
NJ1021	105,000	160,000	26,000	1,84	18	NTN
NJ1022	110,000	170,000	28,000	2,33	18	NTN
NJ1024	120,000	180,000	28,000	2,51	18	NTN
NJ1026	130,000	200,000	33,000	3,79	18	NTN
NJ1028	140,000	210,000	33,000	4,05	18	NTN
NJ1030	150,000	225,000	35,000	4,77	18	NTN
NJ1032	160,000	240,000	38,000	5,90	18	NTN
NJ1034	170,000	260,000	42,000	7,88	18	NTN
NJ1036	180,000	280,000	46,000	10,30	18	NTN
NJ1038	190,000	290,000	46,000	10,70	18	NTN
NJ1040	200,000	310,000	51,000	13,90	18	NTN
NJ1044	220,000	340,000	56,000	18,20	18	NTN
NJ1048	240,000	360,000	56,000	19,60	18	NTN
NJ1052	260,000	400,000	65,000	29,10	18	NTN
NJ1056	280,000	420,000	65,000	30,90	18	NTN
NJ1060	300,000	460,000	74,000	43,60	18	NTN
NJ1064	320,000	480,000	74,000	46,00	18	NTN
NJ1068	340,000	520,000	82,000	61,80	18	NTN
NJ1072	360,000	540,000	82,000	64,70	18	NTN
NJ1076	380,000	560,000	82,000	67,50	18	NTN
NJ1080	400,000	600,000	90,000	87,60	18	NTN
NJ1084	420,000	620,000	90,000	91,00	18	NTN
NJ1088	440,000	650,000	94,000	105,00	18	NTN
NJ1092	460,000	680,000	100,000	122,00	18	NTN
NJ1096	480,000	700,000	100,000	126,00	18	NTN

Reference	d	D	B	Kg	?	Brands
NJ1930	150,000	210,000	28,000	2,98	18	NTN
NJ 202 EG15	15,000	35,000	11,000	0,05	18	SNR
NJ203	17,000	40,000	12,000	0,07	18	NTN
NJ203E	17,000	40,000	12,000	0,07	18	NTN
NJ 203 EG15	17,000	40,000	12,000	0,07	18	SNR
NJ204	20,000	47,000	14,000	0,11	18	NTN
NJ204E	20,000	47,000	14,000	0,12	18	NTN
NJ 204 EG15	20,000	47,000	14,000	0,11	18	SNR
NJ205	25,000	52,000	15,000	0,14	18	NTN
NJ205E	25,000	52,000	15,000	0,15	18	NTN
NJ 205 EG15	25,000	52,000	15,000	0,14	18	SNR
NJ206	30,000	62,000	16,000	0,21	18	NTN
NJ206E	30,000	62,000	16,000	0,23	18	NTN
NJ 206 EG15	30,000	62,000	16,000	0,21	18	SNR
NJ206EJC	30,000	62,000	16,000	0,22	18	NTN
NJ207	35,000	72,000	17,000	0,30	18	NTN
NJ207E	35,000	72,000	17,000	0,33	18	NTN
NJ 207 EG15	35,000	72,000	17,000	0,30	18	SNR
NJ208	40,000	80,000	18,000	0,39	18	NTN
NJ208E	40,000	80,000	18,000	0,43	18	NTN
NJ 208 EG15	40,000	80,000	18,000	0,38	18	SNR
NJ209	45,000	85,000	19,000	0,44	18	NTN
NJ209E	45,000	85,000	19,000	0,50	18	NTN
NJ 209 EG15	45,000	85,000	19,000	0,45	18	SNR
NJ210	50,000	90,000	20,000	0,50	18	NTN
NJ210E	50,000	90,000	20,000	0,54	18	NTN
NJ 210 EG15	50,000	90,000	20,000	0,50	18	SNR
NJ211	55,000	100,000	21,000	0,65	18	NTN
NJ211E	55,000	100,000	21,000	0,72	18	NTN
NJ 211 EG15	55,000	100,000	21,000	0,68	18	SNR
NJ212	60,000	110,000	22,000	0,84	18	NTN
NJ212E	60,000	110,000	22,000	0,92	18	NTN
NJ 212 EG15	60,000	110,000	22,000	0,84	18	SNR
NJ213	65,000	120,000	23,000	1,08	18	NTN
NJ213E	65,000	120,000	23,000	1,21	18	NTN
NJ 213 EG15	65,000	120,000	23,000	1,07	18	SNR
NJ214	70,000	125,000	24,000	1,17	18	NTN
NJ214E	70,000	125,000	24,000	1,30	18	NTN
NJ 214 EG15	70,000	125,000	24,000	1,18	18	SNR
NJ215	75,000	130,000	25,000	1,26	18	NTN
NJ215E	75,000	130,000	25,000	1,41	18	NTN
NJ 215 EG15	75,000	130,000	25,000	1,30	18	SNR
NJ216	80,000	140,000	26,000	1,52	18	NTN
NJ216E	80,000	140,000	26,000	1,67	18	NTN
NJ 216 EG15	80,000	140,000	26,000	1,54	18	SNR
NJ217	85,000	150,000	28,000	1,93	18	NTN
NJ217E	85,000	150,000	28,000	2,11	18	NTN
NJ 217 EG15	85,000	150,000	28,000	1,95	18	SNR
NJ218	90,000	160,000	30,000	2,38	18	NTN
NJ218E	90,000	160,000	30,000	2,44	18	NTN
NJ 218 EG15	90,000	160,000	30,000	2,36	18	SNR
NJ219	95,000	170,000	32,000	2,87	18	NTN



Reference	d	D	B	Kg		Brands
NJ219E	95,000	170,000	32,000	3,02	18	NTN
NJ 219 EG15	95,000	170,000	32,000	2,92	18	SNR
NJ220	100,000	180,000	34,000	3,45	18	NTN
NJ 2203 EG15	17,000	40,000	16,000	0,05	18	SNR
NJ2204	20,000	47,000	18,000	0,15	18	NTN
NJ2204E	20,000	47,000	18,000	0,16	18	NTN
NJ 2204 EG15	20,000	47,000	18,000	0,15	18	SNR
NJ2205	25,000	52,000	18,000	0,17	18	NTN
NJ2205E	25,000	52,000	18,000	0,19	18	NTN
NJ 2205 EG15	25,000	52,000	18,000	0,17	18	SNR
NJ2206	30,000	62,000	20,000	0,27	18	NTN
NJ2206E	30,000	62,000	20,000	0,30	18	NTN
NJ 2206 EG15	30,000	62,000	20,000	0,27	18	SNR
NJ2207	35,000	72,000	23,000	0,42	18	NTN
NJ2207E	35,000	72,000	23,000	0,46	18	NTN
NJ 2207 EG15	35,000	72,000	23,000	0,42	18	SNR
NJ2208	40,000	80,000	23,000	0,50	18	NTN
NJ2208E	40,000	80,000	23,000	0,55	18	NTN
NJ 2208 EG15	40,000	80,000	23,000	0,50	18	SNR
NJ2209	45,000	85,000	23,000	0,54	18	NTN
NJ2209E	45,000	85,000	23,000	0,60	18	NTN
NJ 2209 EG15	45,000	85,000	23,000	0,55	18	SNR
NJ220E	100,000	180,000	34,000	3,66	18	NTN
NJ 220 EG15	100,000	180,000	34,000	3,52	18	SNR
NJ 220 EM	100,000	180,000	34,000	3,93	18	SNR
NJ221	105,000	190,000	36,000	4,10	18	NTN
NJ2210	50,000	90,000	23,000	0,57	18	NTN
NJ2210E	50,000	90,000	23,000	0,65	18	NTN
NJ 2210 EG15	50,000	90,000	23,000	0,57	18	SNR
NJ2211	55,000	100,000	25,000	0,79	18	NTN
NJ2211E	55,000	100,000	25,000	0,97	18	NTN
NJ 2211 EG15	55,000	100,000	25,000	0,78	18	SNR
NJ2212	60,000	110,000	28,000	1,10	18	NTN
NJ2212E	60,000	110,000	28,000	1,21	18	NTN
NJ2212E/54.636	54,636	110,000	28,000	1,25	18	NTN
NJ 2212 EG15	60,000	110,000	28,000	1,10	18	SNR
NJ2213	65,000	120,000	31,000	1,48	18	NTN
NJ2213E	65,000	120,000	31,000	1,60	18	NTN
NJ 2213 EG15	65,000	120,000	31,000	1,47	18	SNR
NJ2214	70,000	125,000	31,000	1,53	18	NTN
NJ2214E	70,000	125,000	31,000	1,70	18	NTN
NJ 2214 EG15	70,000	125,000	31,000	1,52	18	SNR
NJ2215	75,000	130,000	31,000	1,59	18	NTN
NJ2215E	75,000	130,000	31,000	1,79	18	NTN
NJ 2215 EG15	75,000	130,000	31,000	1,59	18	SNR
NJ2216	80,000	140,000	33,000	1,97	18	NTN
NJ2216E	80,000	140,000	33,000	2,12	18	NTN
NJ 2216 EG15	80,000	140,000	33,000	2,04	18	SNR
NJ2217	85,000	150,000	36,000	2,38	18	NTN
NJ2217E	85,000	150,000	36,000	2,68	18	NTN
NJ 2217 EG15	85,000	150,000	36,000	2,55	18	SNR
NJ2218	90,000	160,000	40,000	3,86	18	NTN

Reference	d	D	B	Kg		Brands
NJ2218DF	90,000	160,000	80,000	6,75	18	NTN
NJ2218E	90,000	160,000	40,000	3,33	18	NTN
NJ 2218 EG15	90,000	160,000	40,000	3,21	18	SNR
NJ2219	95,000	170,000	43,000	3,91	18	NTN
NJ2219E	95,000	170,000	43,000	4,14	18	NTN
NJ 2219 EG15	95,000	170,000	43,000	3,95	18	SNR
NJ 221 EG15	105,000	190,000	36,000	4,08	18	SNR
NJ222	110,000	200,000	38,000	4,80	18	NTN
NJ2220	100,000	180,000	46,000	4,74	18	NTN
NJ2220E	100,000	180,000	46,000	5,01	18	NTN
NJ 2220 EG15	100,000	180,000	46,000	4,85	18	SNR
NJ2222	110,000	200,000	53,000	6,70	18	NTN
NJ2222E	110,000	200,000	53,000	7,40	18	NTN
NJ2224	120,000	215,000	58,000	8,43	18	NTN
NJ2224E	120,000	215,000	58,000	9,18	18	NTN
NJ2226	130,000	230,000	64,000	10,60	18	NTN
NJ2226E	130,000	230,000	64,000	11,80	18	NTN
NJ2228	140,000	250,000	68,000	14,21	18	NTN
NJ2228E	140,000	250,000	68,000	15,80	18	NTN
NJ222E	110,000	200,000	38,000	4,84	18	NTN
NJ 222 EG15	110,000	200,000	38,000	5,03	18	SNR
NJ2230	150,000	270,000	73,000	16,30	18	NTN
NJ2230E	150,000	270,000	73,000	19,70	18	NTN
NJ2232	160,000	290,000	80,000	20,20	18	NTN
NJ2232E	160,000	290,000	80,000	25,10	18	NTN
NJ2234	170,000	310,000	86,000	27,20	18	NTN
NJ2234E	170,000	310,000	86,000	31,00	18	NTN
NJ2236	180,000	320,000	86,000	29,60	18	NTN
NJ2236E	180,000	320,000	86,000	31,90	18	NTN
NJ2238	190,000	340,000	92,000	34,40	18	NTN
NJ2238E	190,000	340,000	92,000	39,50	18	NTN
NJ224	120,000	215,000	40,000	5,57	18	NTN
NJ2240	200,000	360,000	98,000	41,30	18	NTN
NJ2240E	200,000	360,000	98,000	47,80	18	NTN
NJ2244	220,000	400,000	108,000	59,00	18	NTN
NJ2248	240,000	440,000	120,000	80,00	18	NTN
NJ224E	120,000	215,000	40,000	6,12	18	NTN
NJ 224 EG15	120,000	215,000	40,000	6,04	18	SNR
NJ2252	260,000	480,000	130,000	104,00	18	NTN
NJ2256	280,000	500,000	130,000	109,00	18	NTN
NJ226	130,000	230,000	40,000	6,66	18	NTN
NJ2260	300,000	540,000	140,000	138,00	18	NTN
NJ2264	320,000	580,000	150,000	172,00	18	NTN
NJ226E	130,000	230,000	40,000	6,90	18	NTN
NJ 226 EG15	130,000	230,000	40,000	6,71	18	SNR
NJ228	140,000	250,000	42,000	8,81	18	NTN
NJ228E	140,000	250,000	42,000	8,73	18	NTN
NJ 228 EM	140,000	250,000	42,000	9,31	18	SNR
NJ230	150,000	270,000	45,000	10,50	18	NTN
NJ2304	20,000	52,000	21,000	0,22	18	NTN
NJ2304E	20,000	52,000	21,000	0,24	18	NTN
NJ 2304 EG15	20,000	52,000	21,000	0,22	18	SNR

Reference	d	D	B	Kg	Brands
NJ2305	25,000	62,000	24,000	0,35	18 NTN
NJ2305E	25,000	62,000	24,000	0,39	18 NTN
NJ 2305 EG15	25,000	62,000	24,000	0,35	18 SNR
NJ2306	30,000	72,000	27,000	0,52	18 NTN
NJ2306E	30,000	72,000	27,000	0,58	18 NTN
NJ 2306 EG15	30,000	72,000	27,000	0,54	18 SNR
NJ2307	35,000	80,000	31,000	0,71	18 NTN
NJ2307E	35,000	80,000	31,000	0,78	18 NTN
NJ 2307 EG15	35,000	80,000	31,000	0,73	18 SNR
NJ2308	40,000	90,000	33,000	1,06	18 NTN
NJ2308E	40,000	90,000	33,000	1,06	18 NTN
NJ 2308 EG15	40,000	90,000	33,000	0,98	18 SNR
NJ2309	45,000	100,000	36,000	1,27	18 NTN
NJ2309E	45,000	100,000	36,000	1,41	18 NTN
NJ2309E/97	45,000	97,000	36,000	1,27	18 NTN
NJ 2309 EG15	45,000	100,000	36,000	1,29	18 SNR
NJ230E	150,000	270,000	45,000	11,00	18 NTN
NJ 230 EM	150,000	270,000	45,000	12,20	18 SNR
NJ2310	50,000	110,000	40,000	1,70	18 NTN
NJ2310E	50,000	110,000	40,000	1,90	18 NTN
NJ 2310 EG15	50,000	110,000	40,000	1,74	18 SNR
NJ2311	55,000	120,000	43,000	2,18	18 NTN
NJ2311E	55,000	120,000	43,000	2,37	18 NTN
NJ 2311 EG15	55,000	120,000	43,000	2,23	18 SNR
NJ2312	60,000	130,000	46,000	2,72	18 NTN
NJ2312E	60,000	130,000	46,000	2,96	18 NTN
NJ 2312 EG15	60,000	130,000	46,000	2,83	18 SNR
NJ2312EJX	60,000	130,000	46,000	2,87	18 NTN
NJ 2312 EM	60,000	130,000	46,000	3,12	18 SNR
NJ2313	65,000	140,000	48,000	3,29	18 NTN
NJ2313E	65,000	140,000	48,000	3,48	18 NTN
NJ 2313 EG15	65,000	140,000	48,000	3,38	18 SNR
NJ2314	70,000	150,000	51,000	4,08	18 NTN
NJ2314E	70,000	150,000	51,000	4,25	18 NTN
NJ2314EDF	70,000	150,000	102,000	4,32	18 NTN
NJ 2314 EG15	70,000	150,000	51,000	4,09	18 SNR
NJ2315	75,000	160,000	55,000	4,75	18 NTN
NJ2315E	75,000	160,000	55,000	5,25	18 NTN
NJ2315EDF	75,000	160,000	110,000	10,50	18 NTN
NJ 2315 EG15	75,000	160,000	55,000	5,04	18 SNR
NJ2316	80,000	170,000	58,000	6,00	18 NTN
NJ2316E	80,000	170,000	58,000	6,25	18 NTN
NJ2317	85,000	180,000	60,000	6,86	18 NTN
NJ2317E	85,000	180,000	60,000	7,16	18 NTN
NJ2317EDF	85,000	180,000	120,000	14,32	18 NTN
NJ2318	90,000	190,000	64,000	8,16	18 NTN
NJ2318E	90,000	190,000	64,000	8,56	18 NTN
NJ 2318 EM	90,000	190,000	64,000	9,63	18 SNR
NJ2319	95,000	200,000	67,000	9,52	18 NTN
NJ2319E	95,000	200,000	67,000	9,80	18 NTN
NJ2319EDF	95,000	200,000	134,000	19,60	18 NTN
NJ232	160,000	290,000	48,000	13,70	18 NTN

Reference	d	D	B	Kg	Brands
NJ2320	100,000	215,000	73,000	11,70	18 NTN
NJ2320E	105,000	215,000	73,000	12,80	18 NTN
NJ2320EDF	100,000	215,000	146,000	25,60	18 NTN
NJ 2320 EM	100,000	215,000	73,000	13,40	18 SNR
NJ2322	110,000	240,000	80,000	18,00	18 NTN
NJ2322E	110,000	240,000	80,000	19,40	18 NTN
NJ2322EDF	110,000	240,000	160,000	35,60	18 NTN
NJ 2322 EM	110,000	240,000	80,000	18,60	18 SNR
NJ2324	120,000	260,000	86,000	22,60	18 NTN
NJ2324E	120,000	260,000	86,000	26,10	18 NTN
NJ 2324 EM	120,000	260,000	86,000	23,80	18 SNR
NJ2326	130,000	280,000	93,000	28,00	18 NTN
NJ2326E	130,000	280,000	93,000	30,90	18 NTN
NJ 2326 EM	130,000	280,000	93,000	29,20	18 SNR
NJ2328	140,000	300,000	102,000	34,90	18 NTN
NJ2328E	140,000	300,000	102,000	38,70	18 NTN
NJ232A	160,000	290,000	48,000	14,00	18 NTN
NJ232E	160,000	290,000	48,000	15,60	18 NTN
NJ 232 EM	160,000	290,000	48,000	15,30	18 SNR
NJ2330	150,000	320,000	108,000	42,10	18 NTN
NJ2330E	150,000	320,000	108,000	47,20	18 NTN
NJ2332	160,000	340,000	114,000	50,50	18 NTN
NJ2332E	160,000	340,000	114,000	56,00	18 NTN
NJ2334	170,000	360,000	120,000	59,50	18 NTN
NJ2336	180,000	380,000	126,000	61,00	18 NTN
NJ2338	190,000	400,000	132,000	80,50	18 NTN
NJ234	170,000	310,000	52,000	17,30	18 NTN
NJ2340	200,000	420,000	138,000	92,60	18 NTN
NJ2344	220,000	460,000	145,000	116,00	18 NTN
NJ2348	240,000	500,000	155,000	147,00	18 NTN
NJ234E	170,000	310,000	52,000	19,60	18 NTN
NJ2352	260,000	540,000	165,000	182,00	18 NTN
NJ2356	280,000	580,000	175,000	222,00	18 NTN
NJ236	180,000	320,000	52,000	18,00	18 NTN
NJ236E	180,000	320,000	52,000	20,40	18 NTN
NJ238	190,000	340,000	55,000	21,80	18 NTN
NJ238E	190,000	340,000	55,000	24,20	18 NTN
NJ240	200,000	360,000	58,000	26,00	18 NTN
NJ240E	200,000	360,000	58,000	28,10	18 NTN
NJ244	220,000	400,000	65,000	37,46	18 NTN
NJ248	240,000	440,000	72,000	50,80	18 NTN
NJ252	260,000	480,000	80,000	56,30	18 NTN
NJ256	280,000	500,000	80,000	70,80	18 NTN
NJ260	300,000	540,000	85,000	88,20	18 NTN
NJ264	320,000	580,000	92,000	111,00	18 NTN
NJ28/530	530,000	650,000	72,000	51,50	18 NTN
NJ29/710	710,000	950,000	140,000	232,00	18 NTN
NJ 303 EG15	17,000	47,000	14,000	0,13	18 SNR
NJ304	20,000	52,000	15,000	0,15	18 NTN
NJ304E	20,000	52,000	15,000	0,18	18 NTN
NJ 304 EG15	20,000	52,000	15,000	0,16	18 SNR
NJ305	25,000	62,000	17,000	0,24	18 NTN



Reference	d	D	B	Kg		Brands
NJ305E	25,000	62,000	17,000	0,28	18	NTN
NJ 305 EG15	25,000	62,000	17,000	0,25	18	SNR
NJ306	30,000	72,000	19,000	0,36	18	NTN
NJ306E	30,000	72,000	19,000	0,40	18	NTN
NJ 306 EG15	30,000	72,000	19,000	0,38	18	SNR
NJ307	35,000	80,000	21,000	0,49	18	NTN
NJ307E	35,000	80,000	21,000	0,55	18	NTN
NJ 307 EG15	35,000	80,000	21,000	0,50	18	SNR
NJ308	40,000	90,000	23,000	0,67	18	NTN
NJ308E	40,000	90,000	23,000	0,75	18	NTN
NJ 308 EG15	40,000	90,000	23,000	0,67	18	SNR
NJ309	45,000	100,000	25,000	0,88	18	NTN
NJ309E	45,000	100,000	25,000	1,00	18	NTN
NJ 309 EG15	45,000	100,000	25,000	0,91	18	SNR
NJ309EJ	45,000	100,000	25,000	0,93	18	NTN
NJ310	50,000	110,000	27,000	1,16	18	NTN
NJ310E	50,000	110,000	27,000	1,30	18	NTN
NJ 310 EG15	50,000	110,000	27,000	1,18	18	SNR
NJ310EJ	50,000	110,000	27,000	1,20	18	NTN
NJ311	55,000	120,000	29,000	1,48	18	NTN
NJ311E	55,000	120,000	29,000	1,65	18	NTN
NJ 311 EG15	55,000	120,000	29,000	1,50	18	SNR
NJ312	60,000	130,000	31,000	1,83	18	NTN
NJ312E	60,000	130,000	31,000	2,05	18	NTN
NJ 312 EG15	60,000	130,000	31,000	1,85	18	SNR
NJ313	65,000	140,000	33,000	2,25	18	NTN
NJ313E	65,000	140,000	33,000	2,54	18	NTN
NJ 313 EG15	65,000	140,000	33,000	2,30	18	SNR
NJ314	70,000	150,000	35,000	2,78	18	NTN
NJ314E	70,000	150,000	35,000	3,10	18	NTN
NJ 314 EG15	70,000	150,000	35,000	2,80	18	SNR
NJ315	75,000	160,000	37,000	3,34	18	NTN
NJ315E	75,000	160,000	37,000	3,74	18	NTN
NJ 315 EG15	75,000	160,000	37,000	3,30	18	SNR
NJ316	80,000	170,000	39,000	3,98	18	NTN
NJ316E	80,000	170,000	39,000	4,22	18	NTN
NJ 316 EG15	80,000	170,000	39,000	4,04	18	SNR
NJ317	85,000	180,000	41,000	4,59	18	NTN
NJ317E	85,000	180,000	41,000	4,81	18	NTN
NJ 317 EG15	85,000	180,000	41,000	4,66	18	SNR
NJ318	90,000	190,000	43,000	5,40	18	NTN
NJ318E	90,000	190,000	43,000	5,72	18	NTN
NJ 318 EG15	90,000	190,000	43,000	5,58	18	SNR
NJ319	95,000	200,000	45,000	6,33	18	NTN
NJ319E	95,000	200,000	45,000	6,62	18	NTN
NJ 319 EG15	95,000	200,000	45,000	6,52	18	SNR
NJ320	100,000	215,000	47,000	7,87	18	NTN
NJ320DF	100,000	215,000	94,000	15,70	18	NTN
NJ320E	100,000	215,000	47,000	8,17	18	NTN
NJ 320 EG15	100,000	215,000	47,000	7,88	18	SNR
NJ321	105,000	225,000	49,000	9,49	18	NTN
NJ322	110,000	240,000	50,000	10,00	18	NTN

Reference	d	D	B	Kg		Brands
NJ322E	110,000	240,000	50,000	11,10	18	NTN
NJ 322 EG15	110,000	240,000	50,000	10,71	18	SNR
NJ 322 EM	110,000	240,000	50,000	11,77	18	SNR
NJ324	120,000	260,000	55,000	13,30	18	NTN
NJ324E	120,000	260,000	55,000	13,90	18	NTN
NJ324EDF	120,000	260,000	110,000	29,60	18	NTN
NJ 324 EG15	120,000	260,000	55,000	13,54	18	SNR
NJ 324 EM	120,000	260,000	55,000	15,37	18	SNR
NJ326	130,000	280,000	58,000	17,60	18	NTN
NJ326E	130,000	280,000	58,000	19,40	18	NTN
NJ 326 EG15	130,000	280,000	58,000	16,75	18	SNR
NJ 326 EM	130,000	280,000	58,000	19,04	18	SNR
NJ328	140,000	300,000	62,000	21,40	18	NTN
NJ328E	140,000	300,000	62,000	23,20	18	NTN
NJ330	150,000	320,000	65,000	25,30	18	NTN
NJ330E	150,000	320,000	65,000	28,40	18	NTN
NJ332	160,000	340,000	68,000	31,30	18	NTN
NJ332E	160,000	340,000	68,000	34,00	18	NTN
NJ334	170,000	360,000	72,000	37,30	18	NTN
NJ336	180,000	380,000	75,000	44,20	18	NTN
NJ338	190,000	400,000	78,000	41,70	18	NTN
NJ340	200,000	420,000	80,000	55,80	18	NTN
NJ344	220,000	460,000	88,000	74,00	18	NTN
NJ348	240,000	500,000	95,000	93,40	18	NTN
NJ352	260,000	540,000	102,000	117,00	18	NTN
NJ356	280,000	580,000	108,000	142,00	18	NTN
NJ405	25,000	80,000	21,000	0,55	18	NTN
NJ406	30,000	90,000	23,000	0,76	18	NTN
NJ407	35,000	100,000	25,000	0,99	18	NTN-SNR
NJ408	40,000	110,000	27,000	1,33	18	NTN-SNR
NJ409	45,000	120,000	29,000	1,62	18	NTN-SNR
NJ410	50,000	130,000	31,000	2,09	18	NTN
NJ 410 M	50,000	130,000	31,000	2,36	18	SNR
NJ411	55,000	140,000	33,000	2,48	18	NTN
NJ412	60,000	150,000	35,000	3,19	18	NTN
NJ413	65,000	160,000	37,000	3,60	18	NTN
NJ414	70,000	180,000	42,000	5,33	18	NTN
NJ 414 M	70,000	180,000	42,000	6,07	18	SNR
NJ415	75,000	190,000	45,000	6,22	18	NTN
NJ416	80,000	200,000	48,000	7,87	18	NTN
NJ417	85,000	210,000	52,000	9,44	18	NTN
NJ418	90,000	225,000	54,000	11,40	18	NTN
NJ420	100,000	250,000	58,000	15,40	18	NTN
NJ421	105,000	260,000	60,000	17,20	18	NTN
NJ422/100	100,000	280,000	65,000	23,50	18	NTN
NJ424	120,000	310,000	72,000	29,90	18	NTN
NJ426	130,000	340,000	78,000	39,40	18	NTN
NJK206	30,000	62,000	16,000	0,22	18	NTN
NJK212	60,000	110,000	22,000	0,87	18	NTN
NJK2210	50,000	90,000	23,000	0,58	18	NTN
NJK2308	40,000	90,000	33,000	1,01	18	NTN
NJK307	35,000	80,000	21,000	0,52	18	NTN

Reference	d	D	B	Kg		Brands
NJK308	40,000	90,000	23,000	0,69	18	NTN
NJK309	45,000	100,000	25,000	0,93	18	NTN
NJK310	50,000	110,000	27,000	1,25	18	NTN
NJK311	55,000	120,000	29,000	1,54	18	NTN
NU10/500	500,000	720,000	100,000	134,00	17	NTN
NU10/530	530,000	780,000	112,000	192,00	17	NTN
NU10/560	560,000	820,000	115,000	216,00	17	NTN
NU10/630	630,000	920,000	128,000	302,00	17	NTN
NU10/800	800,000	1 150,000	155,000	554,00	17	NTN
NU1005	25,000	47,000	12,000	0,09	17	NTN
NU1006	30,000	55,000	13,000	0,13	17	NTN
NU1007	35,000	62,000	14,000	0,18	17	NTN
NU1008	40,000	68,000	15,000	0,21	17	NTN
NU1009	45,000	75,000	16,000	0,28	17	NTN
NU1010	50,000	80,000	16,000	0,29	17	NTN
NU1011	55,000	90,000	18,000	0,44	17	NTN
NU1012	60,000	95,000	18,000	0,47	17	NTN
NU1013	65,000	100,000	18,000	0,49	17	NTN
NU1014	70,000	110,000	20,000	0,62	17	NTN
NU1015	75,000	115,000	20,000	0,74	17	NTN
NU1015/73.333	73,333	115,000	20,000	0,000	17	NTN
NU1016	80,000	125,000	22,000	0,10	17	NTN
NU1017	85,000	130,000	22,000	1,03	17	NTN
NU1018	90,000	140,000	24,000	1,28	17	NTN
NU1019	95,000	145,000	24,000	1,40	17	NTN
NU1020	100,000	150,000	24,000	1,39	17	NTN
NU1021	105,000	160,000	26,000	1,84	17	NTN
NU1022	110,000	170,000	28,000	2,33	17	NTN
NU1024	120,000	180,000	28,000	2,45	17	NTN
NU1026	130,000	200,000	33,000	3,69	17	NTN
NU1028	140,000	210,000	33,000	3,86	17	NTN
NU1030	150,000	225,000	35,000	4,77	17	NTN
NU1030D2	150,000	225,000	70,000	9,54	17	NTN
NU1032	160,000	240,000	38,000	5,90	17	NTN
NU1034	170,000	260,000	42,000	7,86	17	NTN
NU1036	180,000	280,000	46,000	10,30	17	NTN
NU1038	190,000	290,000	46,000	10,70	17	NTN
NU1040	200,000	310,000	51,000	13,90	17	NTN
NU1044	220,000	340,000	56,000	18,30	17	NTN
NU1048	240,000	360,000	56,000	19,60	17	NTN
NU1052	260,000	400,000	65,000	29,30	17	NTN
NU1056	280,000	420,000	65,000	30,90	17	NTN
NU1060	300,000	460,000	74,000	43,50	17	NTN
NU1064	320,000	480,000	74,000	46,00	17	NTN
NU1068	340,000	520,000	82,000	61,80	17	NTN
NU1072	360,000	540,000	82,000	64,70	17	NTN
NU1076	380,000	560,000	82,000	67,50	17	NTN
NU1080	400,000	600,000	90,000	87,60	17	NTN
NU1084	420,000	620,000	90,000	91,00	17	NTN
NU1088	440,000	650,000	94,000	105,00	17	NTN
NU1092	460,000	680,000	100,000	122,00	17	NTN
NU1096	480,000	700,000	100,000	126,00	17	NTN

Reference	d	D	B	Kg		Brands
NU18/500	500,000	620,000	56,000	38,60	17	NTN
NU18/530	530,000	650,000	56,000	41,60	17	NTN
NU1872	360,000	440,000	38,000	11,90	17	NTN
NU19/1250	1 250,000	1 630,000	170,000	975,00	17	NTN
NU19/500	500,000	670,000	78,000	81,30	17	NTN
NU19/530	530,000	710,000	82,000	95,90	17	NTN
NU19/560	560,000	750,000	85,000	91,40	17	NTN
NU19/600	600,000	800,000	90,000	132,00	17	NTN
NU19/630	630,000	850,000	100,000	162,00	17	NTN
NU19/670	670,000	900,000	103,000	195,00	17	NTN
NU19/710	710,000	950,000	106,000	221,00	17	NTN
NU19/750	750,000	1 000,000	112,000	257,00	17	NTN
NU19/850	850,000	1 120,000	118,000	271,00	17	NTN
NU1920	100,000	140,000	20,000	1,01	17	NTN
NU1922	110,000	150,000	20,000	1,09	17	NTN
NU1924	120,000	165,000	22,000	1,48	17	NTN
NU1926	130,000	180,000	24,000	1,95	17	NTN
NU1930	150,000	210,000	28,000	3,17	17	NTN
NU1932	160,000	220,000	28,000	3,35	17	NTN
NU1934	170,000	230,000	28,000	3,52	17	NTN
NU1936	180,000	250,000	33,000	5,21	17	NTN
NU1940	200,000	280,000	38,000	7,65	17	NTN
NU1952	260,000	360,000	46,000	14,90	17	NTN
NU1956	280,000	380,000	46,000	14,86	17	NTN
NU1960	300,000	420,000	56,000	25,40	17	NTN
NU1964	320,000	440,000	56,000	26,80	17	NTN
NU1968	340,000	460,000	56,000	28,20	17	NTN
NU1972	360,000	480,000	56,000	29,60	17	NTN
NU1976	380,000	520,000	65,000	42,90	17	NTN
NU1984	420,000	560,000	65,000	46,70	17	NTN
NU1996	480,000	650,000	78,000	73,10	17	NTN
NU 202 EG15	15,000	35,000	11,000	0,05	17	SNR
NU203	17,000	40,000	12,000	0,07	17	NTN
NU 203 EG15	17,000	40,000	12,000	0,07	17	SNR
NU204	20,000	47,000	14,000	0,11	17	NTN
NU204E	20,000	47,000	14,000	0,12	17	NTN
NU 204 EG15	20,000	47,000	14,000	0,11	17	SNR
NU205	25,000	52,000	15,000	0,13	17	NTN
NU205E	25,000	52,000	15,000	0,15	17	NTN
NU 205 EG15	25,000	52,000	15,000	0,14	17	SNR
NU206	30,000	62,000	16,000	0,20	17	NTN
NU206E	30,000	62,000	16,000	0,23	17	NTN-SNR
NU 206 EG15	30,000	62,000	16,000	0,21	17	SNR
NU206EK	30,000	62,000	16,000	0,20	17	NTN
NU207	35,000	72,000	17,000	0,30	17	NTN
NU207E	35,000	72,000	17,000	0,33	17	NTN-SNR
NU 207 EG15	35,000	72,000	17,000	0,30	17	SNR
NU207EK	35,000	72,000	17,000	0,30	17	NTN
NU 207 EM	35,000	72,000	17,000	0,34	17	SNR
NU207K	35,000	72,000	17,000	0,30	17	NTN
NU208	40,000	80,000	18,000	0,38	17	NTN
NU208E	40,000	80,000	18,000	0,43	17	NTN



Reference	d	D	B	Kg		Brands
NU 208 EG15	40,000	80,000	18,000	0,38	17	SNR
NU 208 EM	40,000	80,000	18,000	0,43	17	SNR
NU208K	40,000	80,000	18,000	0,40	17	NTN
NU209	45,000	85,000	19,000	0,43	17	NTN
NU209E	45,000	85,000	19,000	0,50	17	NTN-SNR
NU 209 EG15	45,000	85,000	19,000	0,44	17	SNR
NU 209 EM	45,000	85,000	19,000	0,49	17	SNR
NU210	50,000	90,000	20,000	0,48	17	NTN
NU210E	50,000	90,000	20,000	0,54	17	NTN-SNR
NU 210 EG15	50,000	90,000	20,000	0,49	17	SNR
NU 210 EM	50,000	90,000	20,000	0,56	17	SNR
NU211	55,000	100,000	21,000	0,64	17	NTN
NU211E	55,000	100,000	21,000	0,72	17	NTN-SNR
NU 211 EG15	55,000	100,000	21,000	0,64	17	SNR
NU 211 EM	55,000	100,000	21,000	0,74	17	SNR
NU212	60,000	110,000	22,000	0,82	17	NTN
NU212E	60,000	110,000	22,000	0,92	17	NTN
NU 212 EG15	60,000	110,000	22,000	0,80	17	SNR
NU 212 EM	60,000	110,000	22,000	0,94	17	SNR
NU213	65,000	120,000	23,000	1,05	17	NTN
NU213E	65,000	120,000	23,000	1,21	17	NTN
NU 213 EG15	65,000	120,000	23,000	1,01	17	SNR
NU 213 EM	65,000	120,000	23,000	1,18	17	SNR
NU214	70,000	125,000	24,000	1,13	17	NTN
NU214E	70,000	125,000	24,000	1,30	17	NTN
NU 214 EG15	70,000	125,000	24,000	1,17	17	SNR
NU 214 EM	70,000	125,000	24,000	1,29	17	SNR
NU215	75,000	130,000	25,000	1,22	17	NTN
NU215E	75,000	130,000	25,000	1,41	17	NTN
NU 215 EG15	75,000	130,000	25,000	1,28	17	SNR
NU 215 EM	75,000	130,000	25,000	1,43	17	SNR
NU216	80,000	140,000	26,000	1,48	17	NTN
NU216E	80,000	140,000	26,000	1,67	17	NTN
NU 216 EG15	80,000	140,000	26,000	1,54	17	SNR
NU 216 EM	80,000	140,000	26,000	1,71	17	SNR
NU217	85,000	150,000	28,000	1,87	17	NTN
NU217E	85,000	150,000	28,000	2,11	17	NTN
NU 217 EG15	85,000	150,000	28,000	1,91	17	SNR
NU 217 EM	85,000	150,000	28,000	2,13	17	SNR
NU218	90,000	160,000	30,000	2,32	17	NTN
NU218E	90,000	160,000	30,000	2,44	17	NTN
NU 218 EG15	90,000	160,000	30,000	2,35	17	SNR
NU 218 EM	90,000	160,000	30,000	2,48	17	SNR
NU219	95,000	170,000	32,000	2,83	17	NTN
NU219E	95,000	170,000	32,000	3,02	17	NTN
NU 219 EG15	95,000	170,000	32,000	2,86	17	SNR
NU 219 EM	95,000	170,000	32,000	2,90	17	SNR
NU220	100,000	180,000	34,000	3,35	17	NTN
NU 2203 EG15	17,000	40,000	16,000	0,05	17	SNR
NU2204	20,000	47,000	18,000	0,14	17	NTN
NU2204E	20,000	47,000	18,000	0,16	17	NTN
NU 2204 EG15	20,000	47,000	18,000	0,14	17	SNR

Reference	d	D	B	Kg		Brands
NU2205	25,000	52,000	18,000	0,15	17	NTN
NU2205E	25,000	52,000	18,000	0,16	17	NTN
NU 2205 EG15	25,000	52,000	18,000	0,17	17	SNR
NU2206	30,000	62,000	20,000	0,26	17	NTN
NU2206E	30,000	62,000	20,000	0,30	17	NTN
NU 2206 EG15	30,000	62,000	20,000	0,26	17	SNR
NU 2206 EM	30,000	62,000	20,000	0,30	17	SNR
NU2207	35,000	72,000	23,000	0,41	17	NTN
NU2207E	35,000	72,000	23,000	0,46	17	NTN
NU 2207 EG15	35,000	72,000	23,000	0,41	17	SNR
NU2208	40,000	80,000	23,000	0,49	17	NTN
NU2208E	40,000	80,000	23,000	0,55	17	NTN
NU 2208 EG15	40,000	80,000	23,000	0,49	17	SNR
NU2209	45,000	85,000	23,000	0,53	17	NTN
NU2209E	45,000	85,000	23,000	0,60	17	NTN
NU2209E/95	45,000	95,000	23,000	0,79	17	NTN
NU 2209 EG15	45,000	85,000	23,000	0,53	17	SNR
NU220E	100,000	180,000	34,000	3,40	17	NTN
NU 220 EG15	100,000	180,000	34,000	3,46	17	SNR
NU 220 EM	100,000	180,000	34,000	3,86	17	SNR
NU221	105,000	190,000	36,000	3,95	17	NTN
NU2210	50,000	90,000	23,000	0,57	17	NTN
NU2210E	50,000	90,000	23,000	0,65	17	NTN
NU 2210 EG15	50,000	90,000	23,000	0,55	17	SNR
NU2211	55,000	100,000	25,000	0,77	17	NTN
NU2211E	55,000	100,000	25,000	0,97	17	NTN
NU 2211 EG15	55,000	100,000	25,000	0,78	17	SNR
NU2212	60,000	110,000	28,000	1,07	17	NTN
NU2212E	60,000	110,000	28,000	1,21	17	NTN
NU 2212 EG15	60,000	110,000	28,000	1,08	17	SNR
NU2213	65,000	120,000	31,000	1,45	17	NTN
NU2213E	65,000	120,000	31,000	1,60	17	NTN
NU 2213 EG15	65,000	120,000	31,000	1,43	17	SNR
NU2214	70,000	125,000	31,000	1,51	17	NTN
NU2214E	70,000	125,000	31,000	1,70	17	NTN
NU 2214 EG15	70,000	125,000	31,000	1,52	17	SNR
NU2215	75,000	130,000	31,000	1,55	17	NTN
NU2215E	75,000	130,000	31,000	1,79	17	NTN
NU 2215 EG15	75,000	130,000	31,000	1,60	17	SNR
NU2216	80,000	140,000	33,000	1,94	17	NTN
NU2216E	80,000	140,000	33,000	2,12	17	NTN
NU 2216 EG15	80,000	140,000	33,000	2,01	17	SNR
NU2217	85,000	150,000	36,000	2,47	17	NTN
NU2217E	85,000	150,000	36,000	2,68	17	NTN
NU 2217 EG15	85,000	150,000	36,000	2,43	17	SNR
NU2218	90,000	160,000	40,000	3,09	17	NTN
NU2218D2	90,000	160,000	80,000	6,18	17	NTN
NU2218E	90,000	160,000	40,000	3,33	17	NTN
NU 2218 EG15	90,000	160,000	40,000	3,17	17	SNR
NU2219	95,000	170,000	43,000	3,80	17	NTN
NU2219E	95,000	170,000	43,000	4,14	17	NTN
NU 2219 EG15	95,000	170,000	43,000	3,90	17	SNR

Reference	d	D	B	Kg		Brands
NU 221 EG15	105,000	190,000	36,000	4,06	17	SNR
NU 221 EM	105,000	190,000	36,000	4,56	17	SNR
NU222	110,000	200,000	38,000	4,69	17	NTN
NU2220	100,000	180,000	46,000	4,57	17	NTN
NU2220E	100,000	180,000	46,000	5,01	17	NTN
NU 2220 EG15	100,000	180,000	46,000	4,74	17	SNR
NU2222	110,000	200,000	53,000	6,55	17	NTN
NU2222E	110,000	200,000	53,000	7,40	17	NTN
NU 2222 EG15	110,000	200,000	53,000	6,73	17	SNR
NU2224	120,000	215,000	58,000	8,22	17	NTN
NU2224E	120,000	215,000	58,000	9,18	17	NTN
NU 2224 EG15	120,000	215,000	58,000	8,39	17	SNR
NU2226	130,000	230,000	64,000	10,30	17	NTN
NU2226E	130,000	230,000	64,000	11,80	17	NTN
NU 2226 EG15	130,000	230,000	64,000	10,40	17	SNR
NU2228	140,000	250,000	68,000	13,10	17	NTN
NU2228E	140,000	250,000	68,000	15,80	17	NTN
NU222E	110,000	200,000	38,000	4,27	17	NTN
NU 222 EG15	110,000	200,000	38,000	4,94	17	SNR
NU 222 EM	110,000	200,000	38,000	5,65	17	SNR
NU2230	150,000	270,000	73,000	16,70	17	NTN
NU2230E	150,000	270,000	73,000	19,70	17	NTN
NU2232	160,000	290,000	80,000	22,70	17	NTN
NU2232E	160,000	290,000	80,000	25,10	17	NTN
NU2234	170,000	310,000	86,000	27,60	17	NTN
NU2234E	170,000	310,000	86,000	31,00	17	NTN
NU2236	180,000	320,000	86,000	29,10	17	NTN
NU2236D2	180,000	320,000	172,000	58,20	17	NTN
NU2236E	180,000	320,000	86,000	31,90	17	NTN
NU2238	190,000	340,000	92,000	35,20	17	NTN
NU2238E	190,000	340,000	92,000	39,50	17	NTN
NU224	120,000	215,000	40,000	5,72	17	NTN
NU2240	200,000	360,000	98,000	41,30	17	NTN
NU2240E	200,000	360,000	98,000	42,50	17	NTN
NU2244	220,000	400,000	108,000	59,00	17	NTN
NU2248	240,000	440,000	120,000	81,50	17	NTN
NU224E	120,000	215,000	40,000	5,97	17	NTN
NU 224 EG15	120,000	215,000	40,000	5,91	17	SNR
NU 224 EM	120,000	215,000	40,000	6,64	17	SNR
NU2252	260,000	480,000	130,000	109,88	17	NTN
NU2256	280,000	500,000	130,000	109,00	17	NTN
NU226	130,000	230,000	40,000	6,50	17	NTN
NU2260	300,000	540,000	140,000	138,00	17	NTN
NU2264	320,000	580,000	150,000	172,00	17	NTN
NU2268	340,000	620,000	165,000	260,00	17	NTN
NU226E	130,000	230,000	40,000	6,72	17	NTN
NU 226 EG15	130,000	230,000	40,000	6,56	17	SNR
NU 226 EM	130,000	230,000	40,000	7,37	17	SNR
NU2272	360,000	650,000	170,000	250,00	17	NTN
NU2276	380,000	680,000	175,000	326,00	17	NTN
NU228	140,000	250,000	42,000	8,20	17	NTN
NU228E	140,000	250,000	42,000	8,73	17	NTN

Reference	d	D	B	Kg		Brands
NU 228 EM	140,000	250,000	42,000	9,59	17	SNR
NU230	150,000	270,000	45,000	10,30	17	NTN
NU2304E	20,000	52,000	21,000	0,24	17	NTN
NU 2304 EG15	20,000	52,000	21,000	0,21	17	SNR
NU2305	25,000	62,000	24,000	0,34	17	NTN
NU2305E	25,000	62,000	24,000	0,39	17	NTN
NU 2305 EG15	25,000	62,000	24,000	0,34	17	SNR
NU2306	30,000	72,000	27,000	0,50	17	NTN
NU2306E	30,000	72,000	27,000	0,58	17	NTN
NU 2306 EG15	30,000	72,000	27,000	0,53	17	SNR
NU2307	35,000	80,000	31,000	0,73	17	NTN
NU2307E	35,000	80,000	31,000	0,78	17	NTN
NU 2307 EG15	35,000	80,000	31,000	0,71	17	SNR
NU2308	40,000	90,000	33,000	0,94	17	NTN
NU2308E	40,000	90,000	33,000	1,06	17	NTN
NU 2308 EG15	40,000	90,000	33,000	0,94	17	SNR
NU2309	45,000	100,000	36,000	1,23	17	NTN
NU2309E	45,000	100,000	36,000	1,41	17	NTN
NU 2309 EG15	45,000	100,000	36,000	1,29	17	SNR
NU230E	150,000	270,000	45,000	11,00	17	NTN
NU 230 EM	150,000	270,000	45,000	12,00	17	SNR
NU2310	50,000	110,000	40,000	1,70	17	NTN
NU2310E	50,000	110,000	40,000	1,90	17	NTN
NU 2310 EG15	50,000	110,000	40,000	1,74	17	SNR
NU2311	55,000	120,000	43,000	2,11	17	NTN
NU2311E	55,000	120,000	43,000	2,37	17	NTN
NU 2311 EG15	55,000	120,000	43,000	2,22	17	SNR
NU2312	60,000	130,000	46,000	2,65	17	NTN
NU2312E	60,000	130,000	46,000	2,96	17	NTN
NU 2312 EG15	60,000	130,000	46,000	2,76	17	SNR
NU2313	65,000	140,000	48,000	3,21	17	NTN
NU2313E	65,000	140,000	48,000	3,48	17	NTN
NU 2313 EG15	65,000	140,000	48,000	3,32	17	SNR
NU 2313 EM	65,000	140,000	48,000	3,60	17	SNR
NU2314	70,000	150,000	51,000	3,97	17	NTN
NU2314E	70,000	150,000	51,000	4,25	17	NTN
NU 2314 EG15	70,000	150,000	51,000	4,02	17	SNR
NU 2314 EM	70,000	150,000	51,000	4,39	17	SNR
NU2315	75,000	160,000	55,000	4,81	17	NTN
NU2315E	75,000	160,000	55,000	5,25	17	NTN
NU 2315 EG15	75,000	160,000	55,000	4,95	17	SNR
NU 2315 EM	75,000	160,000	55,000	6,00	17	SNR
NU2316	80,000	170,000	58,000	5,84	17	NTN
NU2316E	80,000	170,000	58,000	6,25	17	NTN
NU 2316 EG15	80,000	170,000	58,000	6,00	17	SNR
NU 2316 EM	80,000	170,000	58,000	6,50	17	SNR
NU2317	85,000	180,000	60,000	6,68	17	NTN
NU2317E	85,000	180,000	60,000	7,16	17	NTN
NU 2317 EG15	85,000	180,000	60,000	6,85	17	SNR
NU2317K	85,000	180,000	60,000	6,92	17	NTN
NU2318	90,000	190,000	64,000	7,93	17	NTN
NU2318E	90,000	190,000	64,000	8,56	17	NTN



Reference	d	D	B	Kg	?	Brands
NU 2318 EG15	90,000	190,000	64,000	8,00	17	SNR
NU2318K	90,000	190,000	64,000	7,76	17	NTN
NU2319	95,000	200,000	67,000	9,24	17	NTN
NU2319E	95,000	200,000	67,000	9,80	17	NTN
NU 2319 EG15	95,000	200,000	67,000	9,40	17	SNR
NU 2319 EM	95,000	200,000	67,000	10,20	17	SNR
NU2319K	95,000	200,000	67,000	9,04	17	NTN
NU232	160,000	290,000	48,000	13,70	17	NTN
NU2320	100,000	215,000	73,000	11,70	17	NTN
NU2320E	100,000	215,000	73,000	12,50	17	NTN
NU 2320 EG15	100,000	215,000	73,000	12,00	17	SNR
NU2322	110,000	240,000	80,000	17,10	17	NTN
NU2322E	110,000	240,000	80,000	17,30	17	NTN
NU 2322 EM	110,000	240,000	80,000	18,21	17	SNR
NU2322K	110,000	240,000	80,000	17,20	17	NTN
NU2324	120,000	260,000	86,000	22,10	17	NTN
NU2324E	120,000	260,000	86,000	26,10	17	NTN
NU 2324 EM	120,000	260,000	86,000	23,19	17	SNR
NU2326	130,000	280,000	93,000	27,50	17	NTN
NU2326E	130,000	280,000	93,000	30,90	17	NTN
NU 2326 EM	130,000	280,000	93,000	28,73	17	SNR
NU2328	140,000	300,000	102,000	34,10	17	NTN
NU2328E	140,000	300,000	102,000	38,70	17	NTN
NU 2328 EM	140,000	300,000	102,000	36,00	17	SNR
NU232E	160,000	290,000	48,000	13,70	17	NTN
NU 232E M	160,000	290,000	48,000	3,34	17	SNR
NU2330	150,000	320,000	108,000	40,60	17	NTN
NU2330E	150,000	320,000	108,000	47,20	17	NTN
NU 2330 EM	150,000	320,000	108,000	43,20	17	SNR
NU2330K	150,000	320,000	108,000	40,50	17	NTN
NU2332	160,000	340,000	114,000	50,40	17	NTN
NU2332E	160,000	340,000	114,000	56,00	17	NTN
NU 2332 EM	160,000	340,000	114,000	51,50	17	SNR
NU2334	170,000	360,000	120,000	59,70	17	NTN
NU2336	180,000	380,000	126,000	69,50	17	NTN
NU2338	190,000	400,000	132,000	80,72	17	NTN
NU234	170,000	310,000	52,000	17,00	17	NTN
NU2340	200,000	420,000	138,000	92,60	17	NTN
NU2344	220,000	460,000	145,000	116,00	17	NTN
NU2348	240,000	500,000	155,000	147,00	17	NTN
NU234E	170,000	310,000	52,000	19,60	17	NTN
NU 234 EM	170,000	310,000	52,000	17,96	17	SNR
NU2352	260,000	540,000	165,000	182,00	17	NTN
NU2356	280,000	580,000	175,000	222,00	17	NTN
NU236	180,000	320,000	52,000	17,70	17	NTN
NU2360	300,000	620,000	185,000	316,00	17	NTN
NU2364	320,000	670,000	200,000	402,00	17	NTN
NU2368	340,000	710,000	212,000	477,00	17	NTN
NU236E	180,000	320,000	52,000	20,40	17	NTN
NU 236 EM	180,000	320,000	52,000	19,13	17	SNR
NU2372	360,000	750,000	224,000	562,00	17	NTN
NU238	190,000	340,000	55,000	21,30	17	NTN

Reference	d	D	B	Kg	?	Brands
NU238E	190,000	340,000	55,000	24,20	17	NTN
NU 238 EM	190,000	340,000	55,000	23,04	17	SNR
NU240	200,000	360,000	58,000	25,50	17	NTN
NU240E	200,000	360,000	58,000	28,10	17	NTN
NU244	220,000	400,000	65,000	37,70	17	NTN
NU248	240,000	440,000	72,000	49,90	17	NTN
NU252	260,000	480,000	80,000	66,40	17	NTN
NU256	280,000	500,000	80,000	70,80	17	NTN
NU260	300,000	540,000	85,000	88,20	17	NTN
NU264	320,000	580,000	92,000	111,00	17	NTN
NU28/500	500,000	620,000	72,000	50,70	17	NTN
NU28/560	560,000	680,000	72,000	56,10	17	NTN
NU28/600	600,000	730,000	78,000	70,70	17	NTN
NU28/630	630,000	780,000	88,000	97,50	17	NTN
NU28/670	670,000	820,000	88,000	103,00	17	NTN
NU28/800	800,000	980,000	106,000	178,00	17	NTN
NU28/850	850,000	1 030,000	106,000	188,00	17	NTN
NU2892	460,000	580,000	72,000	47,10	17	NTN
NU29/1060	1 060,000	1 400,000	195,000	855,00	17	NTN
NU29/1180	1 180,000	1 540,000	206,000	1 060,00	17	NTN
NU29/530	530,000	710,000	106,000	124,00	17	NTN
NU29/560	560,000	750,000	112,000	146,00	17	NTN
NU29/600	600,000	800,000	118,000	171,19	17	NTN
NU29/630	630,000	850,000	128,000	218,00	17	NTN
NU29/670	670,000	900,000	136,000	257,00	17	NTN
NU29/710	710,000	950,000	140,000	287,34	17	NTN
NU29/750	750,000	1 000,000	145,000	332,00	17	NTN
NU29/800	800,000	1 060,000	150,000	380,00	17	NTN
NU29/850	850,000	1 120,000	155,000	432,00	17	NTN
NU2924	120,000	165,000	27,000	1,81	17	NTN
NU2926	130,000	180,000	30,000	2,44	17	NTN
NU2928	140,000	190,000	30,000	2,59	17	NTN
NU2930	150,000	210,000	36,000	4,08	17	NTN
NU2932	160,000	220,000	36,000	4,30	17	NTN
NU2934	170,000	230,000	36,000	4,53	17	NTN
NU2936	180,000	250,000	42,000	6,63	17	NTN
NU2938	190,000	260,000	42,000	6,93	17	NTN
NU2940	200,000	280,000	48,000	9,66	17	NTN
NU2944	220,000	300,000	48,000	10,50	17	NTN
NU2948	240,000	320,000	48,000	11,30	17	NTN
NU2952	260,000	360,000	60,000	19,50	17	NTN
NU2956	280,000	380,000	60,000	20,80	17	NTN
NU2960	300,000	420,000	72,000	32,60	17	NTN
NU2968	340,000	460,000	72,000	33,90	17	NTN
NU2972	360,000	480,000	72,000	38,00	17	NTN
NU2976	380,000	520,000	82,000	54,10	17	NTN
NU2984	420,000	560,000	82,000	59,00	17	NTN
NU2988	440,000	600,000	95,000	82,00	17	NTN
NU2996	480,000	650,000	100,000	101,00	17	NTN
NU30/530	530,000	780,000	185,000	318,00	17	NTN
NU30/600	600,000	870,000	200,000	416,00	17	NTN
NU30/710	710,000	1 030,000	236,000	677,00	17	NTN

Reference	d	D	B	Kg		Brands
NU3028	140,000	210,000	53,000	6,80	17	NTN
NU3036	180,000	280,000	74,000	17,80	17	NTN
NU 303 EG15	17,000	47,000	14,000	0,12	17	SNR
NU304	20,000	52,000	15,000	0,15	17	NTN
NU3040	200,000	310,000	82,000	24,10	17	NTN
NU3044	220,000	340,000	90,000	31,70	17	NTN
NU3048	240,000	360,000	92,000	34,70	17	NTN
NU304E	20,000	52,000	15,000	0,18	17	NTN
NU 304 EG15	20,000	52,000	15,000	0,16	17	SNR
NU305	25,000	62,000	17,000	0,23	17	NTN
NU3052	260,000	400,000	104,000	50,40	17	NTN
NU3056	280,000	420,000	106,000	54,40	17	NTN
NU305E	25,000	62,000	17,000	0,28	17	NTN
NU 305 EG15	25,000	62,000	17,000	0,24	17	SNR
NU306	30,000	72,000	19,000	0,36	17	NTN
NU3060	300,000	460,000	118,000	75,20	17	NTN
NU3064	320,000	480,000	121,000	81,20	17	NTN
NU3068	340,000	520,000	133,000	108,00	17	NTN
NU306E	30,000	72,000	19,000	0,40	17	NTN
NU 306 EG15	30,000	72,000	19,000	0,37	17	SNR
NU307	35,000	80,000	21,000	0,48	17	NTN
NU3072	360,000	540,000	134,000	114,00	17	NTN
NU3076	380,000	560,000	135,000	120,00	17	NTN
NU307E	35,000	80,000	21,000	0,55	17	NTN
NU 307 EG15	35,000	80,000	21,000	0,48	17	SNR
NU307EJ	35,000	80,000	21,000	0,49	17	NTN
NU308	40,000	90,000	23,000	0,66	17	NTN
NU3080	400,000	600,000	148,000	155,00	17	NTN
NU3088	440,000	650,000	157,000	188,00	17	NTN
NU308E	40,000	90,000	23,000	0,75	17	NTN
NU 308 EG15	40,000	90,000	23,000	0,66	17	SNR
NU309	45,000	100,000	25,000	0,86	17	NTN
NU309E	45,000	100,000	25,000	1,00	17	NTN
NU 309 EG15	45,000	100,000	25,000	0,90	17	SNR
NU 309 EM	45,000	100,000	25,000	1,07	17	SNR
NU31/500	500,000	830,000	264,000	588,00	17	NTN
NU310	50,000	110,000	27,000	1,13	17	NTN
NU310E	50,000	110,000	27,000	1,30	17	NTN
NU 310 EG15	50,000	110,000	27,000	1,16	17	SNR
NU 310 EM	50,000	110,000	27,000	1,29	17	SNR
NU311	55,000	120,000	29,000	1,44	17	NTN
NU311E	55,000	120,000	29,000	1,65	17	NTN
NU 311 EG15	55,000	120,000	29,000	1,47	17	SNR
NU 311 EM	55,000	120,000	29,000	1,61	17	SNR
NU312	60,000	130,000	31,000	1,80	17	NTN
NU312E	60,000	130,000	31,000	2,05	17	NTN
NU 312 EG15	60,000	130,000	31,000	1,82	17	SNR
NU 312 EM	60,000	130,000	31,000	2,04	17	SNR
NU313	65,000	140,000	33,000	2,19	17	NTN
NU3132	160,000	270,000	86,000	20,60	17	NTN
NU313E	65,000	140,000	33,000	2,54	17	NTN
NU 313 EG15	65,000	140,000	33,000	2,22	17	SNR

Reference	d	D	B	Kg		Brands
NU 313 EM	65,000	140,000	33,000	2,53	17	SNR
NU314	70,000	150,000	35,000	2,71	17	NTN
NU3140A	200,000	340,000	112,000	42,80	17	NTN
NU3144	220,000	370,000	120,000	53,30	17	NTN
NU314E	70,000	150,000	35,000	3,10	17	NTN
NU 314 EG15	70,000	150,000	35,000	2,75	17	SNR
NU 314 EM	70,000	150,000	35,000	3,08	17	SNR
NU315	75,000	160,000	37,000	3,27	17	NTN
NU3152	260,000	440,000	144,000	95,10	17	NTN
NU315E	75,000	160,000	37,000	3,74	17	NTN
NU 315 EG15	75,000	160,000	37,000	3,30	17	SNR
NU 315 EM	75,000	160,000	37,000	3,73	17	SNR
NU316	80,000	170,000	39,000	3,86	17	NTN
NU3164	320,000	540,000	176,000	175,00	17	NTN
NU3168	340,000	580,000	190,000	204,00	17	NTN
NU316E	80,000	170,000	39,000	4,22	17	NTN
NU 316 EG15	80,000	170,000	39,000	3,96	17	SNR
NU 316 EM	80,000	170,000	39,000	4,41	17	SNR
NU317	85,000	180,000	41,000	4,47	17	NTN
NU3172A	360,000	600,000	192,000	232,00	17	NTN
NU317E	85,000	180,000	41,000	4,81	17	NTN
NU 317 EG15	85,000	180,000	41,000	4,57	17	SNR
NU 317 EM	85,000	180,000	41,000	5,20	17	SNR
NU318	90,000	190,000	43,000	5,30	17	NTN
NU3184	420,000	700,000	224,000	340,00	17	NTN
NU318E	90,000	190,000	43,000	5,72	17	NTN
NU 318 EG15	90,000	190,000	43,000	5,34	17	SNR
NU 318 EM	90,000	190,000	43,000	6,27	17	SNR
NU319	95,000	200,000	45,000	6,16	17	NTN
NU319E	95,000	200,000	45,000	6,62	17	NTN
NU 319 EG15	95,000	200,000	45,000	6,37	17	SNR
NU 319 EM	95,000	200,000	45,000	7,07	17	SNR
NU320	100,000	215,000	47,000	7,49	17	NTN
NU320E	100,000	215,000	47,000	8,57	17	NTN
NU 320 EG15	100,000	215,000	47,000	7,66	17	SNR
NU 320 EM	100,000	215,000	47,000	8,40	17	SNR
NU321	105,000	225,000	49,000	8,56	17	NTN
NU3210	50,000	90,000	30,200	0,73	17	NTN
NU3214	70,000	125,000	39,700	1,70	17	NTN
NU3215	75,000	130,000	41,300	2,01	17	NTN
NU3218	90,000	160,000	52,400	4,74	17	NTN
NU3219	95,000	170,000	55,600	5,27	17	NTN
NU 321 EM	105,000	225,000	49,000	9,98	17	SNR
NU322	110,000	240,000	50,000	10,00	17	NTN
NU3220	100,000	180,000	60,300	7,60	17	NTN
NU3221	105,000	190,000	65,100	8,25	17	NTN
NU3222	110,000	200,000	69,800	9,20	17	NTN
NU3224	120,000	215,000	76,000	12,20	17	NTN
NU3226	130,000	230,000	80,000	14,60	17	NTN
NU3228	140,000	250,000	88,000	19,10	17	NTN
NU322E	110,000	240,000	50,000	11,10	17	NTN
NU 322 EG15	110,000	240,000	50,000	10,37	17	SNR



Reference	d	D	B	Kg		Brands
NU 322 EM	110,000	240,000	50,000	11,60	17	SNR
NU3230	150,000	270,000	96,000	24,50	17	NTN
NU3234	170,000	310,000	110,000	37,40	17	NTN
NU3236	180,000	320,000	112,000	39,60	17	NTN
NU3238	190,000	340,000	120,000	48,20	17	NTN
NU324	120,000	260,000	55,000	12,80	17	NTN
NU3240	200,000	360,000	128,000	58,00	17	NTN
NU3244	220,000	400,000	144,000	84,20	17	NTN
NU324E	120,000	260,000	55,000	13,90	17	NTN
NU 324 EG15	120,000	260,000	55,000	13,57	17	SNR
NU326	130,000	280,000	58,000	17,20	17	NTN
NU3260	300,000	540,000	192,000	193,00	17	NTN
NU3268	340,000	620,000	224,000	316,00	17	NTN
NU326E	130,000	280,000	58,000	19,40	17	NTN
NU 326 EG15	130,000	280,000	58,000	16,46	17	SNR
NU3272	360,000	650,000	232,000	356,00	17	NTN
NU3276	380,000	680,000	240,000	400,00	17	NTN
NU328	140,000	300,000	62,000	21,20	17	NTN
NU3280	400,000	720,000	256,000	451,00	17	NTN
NU3284	420,000	760,000	272,000	548,00	17	NTN
NU328E	140,000	300,000	62,000	23,20	17	NTN
NU 328 EG15	140,000	300,000	62,000	20,39	17	SNR
NU 328 EM	140,000	300,000	62,000	22,47	17	SNR
NU330	150,000	320,000	65,000	24,70	17	NTN
NU330E	150,000	320,000	65,000	28,40	17	NTN
NU 330 EM	150,000	320,000	65,000	27,30	17	SNR
NU3314	70,000	150,000	63,500	5,20	17	NTN
NU332	160,000	340,000	68,000	30,80	17	NTN
NU3322A	110,000	240,000	92,100	20,20	17	NTN
NU3324	120,000	260,000	106,000	27,10	17	NTN
NU3326	130,000	280,000	112,000	33,10	17	NTN
NU332E	160,000	340,000	68,000	34,00	17	NTN
NU3336	180,000	380,000	150,000	88,00	17	NTN
NU3338	190,000	400,000	155,000	101,00	17	NTN
NU334	170,000	360,000	72,000	37,00	17	NTN
NU3340	200,000	420,000	165,000	118,10	17	NTN
NU3352	260,000	540,000	206,000	242,00	17	NTN
NU336	180,000	380,000	75,000	42,30	17	NTN
NU338	190,000	400,000	78,000	49,40	17	NTN
NU340	200,000	420,000	80,000	55,02	17	NTN
NU344	220,000	460,000	88,000	73,40	17	NTN
NU348	240,000	500,000	95,000	92,70	17	NTN
NU352	260,000	540,000	102,000	117,00	17	NTN
NU356	280,000	580,000	108,000	142,00	17	NTN
NU368	340,000	710,000	118,000	246,00	17	NTN
NU38/560	560,000	680,000	90,000	72,70	17	NTN
NU38/670	670,000	820,000	112,000	136,00	17	NTN
NU3860	300,000	380,000	60,000	17,10	17	NTN
NU3864	320,000	400,000	60,000	18,10	17	NTN
NU3872	360,000	440,000	60,000	20,10	17	NTN
NU3880	400,000	500,000	75,000	35,40	17	NTN
NU3956	280,000	380,000	75,000	25,60	17	NTN

Reference	d	D	B	Kg		Brands
NU3964	320,000	440,000	90,000	42,20	17	NTN
NU405	25,000	80,000	21,000	0,55	17	NTN
NU406	30,000	90,000	23,000	0,75	17	NTN
NU407	35,000	100,000	25,000	0,99	17	NTN-SNR
NU408	40,000	110,000	27,000	1,34	17	NTN-SNR
NU409	45,000	120,000	29,000	1,62	17	NTN-SNR
NU410	50,000	130,000	31,000	2,12	17	NTN-SNR
NU411	55,000	140,000	33,000	2,48	17	NTN
NU412	60,000	150,000	35,000	3,13	17	NTN
NU 412 M	60,000	150,000	35,000	3,41	17	SNR
NU413	65,000	160,000	37,000	3,60	17	NTN
NU414	70,000	180,000	42,000	5,56	17	NTN
NU415	75,000	190,000	45,000	6,22	17	NTN
NU416	80,000	200,000	48,000	7,71	17	NTN
NU417	85,000	210,000	52,000	9,24	17	NTN
NU418	90,000	225,000	54,000	11,20	17	NTN
NU419	95,000	240,000	55,000	13,20	17	NTN
NU420	100,000	250,000	58,000	15,10	17	NTN
NU421	105,000	260,000	60,000	16,80	17	NTN
NU421K	105,000	260,000	60,000	14,70	17	NTN
NU422	110,000	280,000	65,000	21,40	17	NTN
NU424	120,000	310,000	72,000	29,30	17	NTN
NU426	130,000	340,000	78,000	38,60	17	NTN
NU428	140,000	360,000	82,000	45,30	17	NTN
NU430	150,000	380,000	85,000	52,10	17	NTN
NUP10/500	500,000	720,000	100,000	130,00	19	NTN
NUP1005	25,000	47,000	12,000	0,09	19	NTN
NUP1006	30,000	55,000	13,000	0,13	19	NTN
NUP1007	35,000	62,000	14,000	0,18	19	NTN
NUP1008	40,000	68,000	15,000	0,22	19	NTN
NUP1009	45,000	75,000	16,000	0,28	19	NTN
NUP1010	50,000	80,000	16,000	0,30	19	NTN
NUP1011	55,000	90,000	18,000	0,44	19	NTN
NUP1012	60,000	95,000	18,000	0,47	19	NTN
NUP1013	65,000	100,000	18,000	0,49	19	NTN
NUP1014	70,000	110,000	20,000	0,70	19	NTN
NUP1015	75,000	115,000	20,000	0,74	19	NTN
NUP1016	80,000	125,000	22,000	0,98	19	NTN
NUP1017	85,000	130,000	22,000	1,03	19	NTN
NUP1018	90,000	140,000	24,000	1,33	19	NTN
NUP1019	95,000	145,000	24,000	1,40	19	NTN
NUP1020	100,000	150,000	24,000	1,45	19	NTN
NUP1021	105,000	160,000	26,000	1,84	19	NTN
NUP1022	110,000	170,000	28,000	2,33	19	NTN
NUP1024	120,000	180,000	28,000	2,44	19	NTN
NUP1026	130,000	200,000	33,000	3,69	19	NTN
NUP1028	140,000	210,000	33,000	4,05	19	NTN
NUP1030	150,000	225,000	35,000	4,77	19	NTN
NUP1032	160,000	240,000	38,000	5,90	19	NTN
NUP1034	170,000	260,000	42,000	7,88	19	NTN
NUP1036	180,000	280,000	46,000	10,30	19	NTN
NUP1038	190,000	290,000	46,000	10,70	19	NTN

Reference	d	D	B	Kg	?	Brands
NUP1040	200,000	310,000	51,000	13,90	19	NTN
NUP1044	220,000	340,000	56,000	18,20	19	NTN
NUP1048	240,000	360,000	56,000	19,60	19	NTN
NUP1052	260,000	400,000	65,000	29,10	19	NTN
NUP1056	280,000	420,000	65,000	30,90	19	NTN
NUP1060	300,000	460,000	74,000	43,60	19	NTN
NUP1064	320,000	480,000	74,000	46,00	19	NTN
NUP1068	340,000	520,000	82,000	61,80	19	NTN
NUP1072	360,000	540,000	82,000	64,70	19	NTN
NUP1076	380,000	560,000	82,000	67,50	19	NTN
NUP1080	400,000	600,000	90,000	87,60	19	NTN
NUP1084	420,000	620,000	90,000	91,00	19	NTN
NUP1088	440,000	650,000	94,000	105,00	19	NTN
NUP1092	460,000	680,000	100,000	122,00	19	NTN
NUP1096	480,000	700,000	100,000	126,00	19	NTN
NUP203	17,000	40,000	12,000	0,07	19	NTN
NUP204	20,000	47,000	14,000	0,12	19	NTN
NUP204E	20,000	47,000	14,000	0,12	19	NTN
NUP204E/22	22,000	47,000	14,000	0,11	19	NTN
NUP 204 EG15	20,000	47,000	14,000	0,12	19	SNR
NUP205	25,000	52,000	15,000	0,15	19	NTN
NUP205E	25,000	52,000	15,000	0,15	19	NTN
NUP 205 EG15	25,000	52,000	15,000	0,14	19	SNR
NUP206	30,000	62,000	16,000	0,22	19	NTN
NUP206E	30,000	62,000	16,000	0,23	19	NTN
NUP 206 EG15	30,000	62,000	16,000	0,22	19	SNR
NUP207	35,000	72,000	17,000	0,31	19	NTN
NUP207E	35,000	72,000	17,000	0,33	19	NTN
NUP 207 EG15	35,000	72,000	17,000	0,30	19	SNR
NUP208	40,000	80,000	18,000	0,40	19	NTN
NUP208E	40,000	80,000	18,000	0,43	19	NTN
NUP 208 EG15	40,000	80,000	18,000	0,43	19	SNR
NUP209	45,000	85,000	19,000	0,46	19	NTN
NUP209E	45,000	85,000	19,000	0,50	19	NTN
NUP 209 EG15	45,000	85,000	19,000	0,46	19	SNR
NUP 209 ENRG15	45,000	85,000	19,000	0,47	19	SNR
NUP210	50,000	90,000	20,000	0,54	19	NTN
NUP210E	50,000	90,000	20,000	0,54	19	NTN
NUP 210 EG15	50,000	90,000	20,000	0,52	19	SNR
NUP211	55,000	100,000	21,000	0,64	19	NTN
NUP211E	55,000	100,000	21,000	0,72	19	NTN
NUP 211 EG15	55,000	100,000	21,000	0,69	19	SNR
NUP212	60,000	110,000	22,000	0,92	19	NTN
NUP212E	60,000	110,000	22,000	0,92	19	NTN
NUP 212 EG15	60,000	110,000	22,000	0,86	19	SNR
NUP213	65,000	120,000	23,000	1,20	19	NTN
NUP213E	65,000	120,000	23,000	1,21	19	NTN
NUP 213 EG15	65,000	120,000	23,000	1,09	19	SNR
NUP214	70,000	125,000	24,000	1,12	19	NTN
NUP214E	70,000	125,000	24,000	1,30	19	NTN
NUP 214 EG15	70,000	125,000	24,000	1,21	19	SNR
NUP215	75,000	130,000	25,000	1,30	19	NTN

Reference	d	D	B	Kg	?	Brands
NUP215E	75,000	130,000	25,000	1,41	19	NTN
NUP 215 EG15	75,000	130,000	25,000	1,34	19	SNR
NUP216	80,000	140,000	26,000	1,60	19	NTN
NUP216E	80,000	140,000	26,000	1,67	19	NTN
NUP217	85,000	150,000	28,000	1,87	19	NTN
NUP217E	85,000	150,000	28,000	2,11	19	NTN
NUP218	90,000	160,000	30,000	2,43	19	NTN
NUP218E	90,000	160,000	30,000	2,44	19	NTN
NUP219	95,000	170,000	32,000	2,95	19	NTN
NUP219E	95,000	170,000	32,000	3,02	19	NTN
NUP220	100,000	180,000	34,000	3,33	19	NTN
NUP2204E	20,000	47,000	18,000	0,16	19	NTN
NUP2205	25,000	52,000	18,000	0,16	19	NTN
NUP2205E	25,000	52,000	18,000	0,19	19	NTN
NUP 2205 EG15	25,000	52,000	18,000	0,18	19	SNR
NUP2206	30,000	62,000	20,000	0,27	19	NTN
NUP2206E	30,000	62,000	20,000	0,30	19	NTN
NUP 2206 EG15	30,000	62,000	20,000	0,27	19	SNR
NUP2207E	35,000	72,000	23,000	0,42	19	NTN
NUP 2207 EG15	35,000	72,000	23,000	0,60	19	SNR
NUP2208	40,000	80,000	23,000	0,51	19	NTN
NUP2208E	40,000	80,000	23,000	0,55	19	NTN
NUP 2208 EG15	40,000	80,000	23,000	0,51	19	SNR
NUP2209	45,000	85,000	23,000	0,56	19	NTN
NUP2209E	45,000	85,000	23,000	0,60	19	NTN
NUP 2209 EG15	45,000	85,000	23,000	0,54	19	SNR
NUP220E	100,000	180,000	34,000	3,66	19	NTN
NUP221	105,000	190,000	36,000	4,20	19	NTN
NUP2210	50,000	90,000	23,000	0,57	19	NTN
NUP2210E	50,000	90,000	23,000	0,65	19	NTN
NUP 2210 EG15	50,000	90,000	23,000	0,60	19	SNR
NUP2211	55,000	100,000	25,000	0,80	19	NTN
NUP2211E	55,000	100,000	25,000	0,97	19	NTN
NUP 2211 EG15	55,000	100,000	25,000	0,83	19	SNR
NUP2212	60,000	110,000	28,000	1,12	19	NTN
NUP2212E	60,000	110,000	28,000	1,21	19	NTN
NUP 2212 EG15	60,000	110,000	28,000	1,13	19	SNR
NUP2213	65,000	120,000	31,000	1,51	19	NTN
NUP2213E	65,000	120,000	31,000	1,60	19	NTN
NUP2214	70,000	125,000	31,000	1,57	19	NTN
NUP2214E	70,000	125,000	31,000	1,70	19	NTN
NUP2215	75,000	130,000	31,000	1,62	19	NTN
NUP2215E	75,000	130,000	31,000	1,79	19	NTN
NUP2216	80,000	140,000	33,000	2,01	19	NTN
NUP2216E	80,000	140,000	33,000	2,12	19	NTN
NUP2217	85,000	150,000	36,000	2,44	19	NTN
NUP2217E	85,000	150,000	36,000	2,68	19	NTN
NUP2218	90,000	160,000	40,000	3,22	19	NTN
NUP2219	95,000	170,000	43,000	3,99	19	NTN
NUP2219E	95,000	170,000	43,000	4,14	19	NTN
NUP222	110,000	200,000	38,000	4,93	19	NTN
NUP2220	100,000	180,000	46,000	4,57	19	NTN



Reference	d	D	B	Kg	?	Brands
NUP2220E	100,000	180,000	46,000	5,01	19	NTN
NUP2222	110,000	200,000	53,000	6,86	19	NTN
NUP2222E	110,000	200,000	53,000	7,40	19	NTN
NUP2224	120,000	215,000	58,000	8,64	19	NTN
NUP2224E	120,000	215,000	58,000	9,18	19	NTN
NUP2226	130,000	230,000	64,000	10,20	19	NTN
NUP2226E	130,000	230,000	64,000	11,80	19	NTN
NUP2228	140,000	250,000	68,000	12,90	19	NTN
NUP2228E	140,000	250,000	68,000	15,80	19	NTN
NUP222E	110,000	200,000	38,000	4,27	19	NTN
NUP2230	150,000	270,000	73,000	15,90	19	NTN
NUP2230E	150,000	270,000	73,000	19,70	19	NTN
NUP2232	160,000	290,000	80,000	22,00	19	NTN
NUP2232E	160,000	290,000	80,000	25,10	19	NTN
NUP2234	170,000	310,000	86,000	27,20	19	NTN
NUP2234E	170,000	310,000	86,000	31,00	19	NTN
NUP2236	180,000	320,000	86,000	28,40	19	NTN
NUP2236E	180,000	320,000	86,000	31,90	19	NTN
NUP2238	190,000	340,000	92,000	34,40	19	NTN
NUP2238E	190,000	340,000	92,000	39,50	19	NTN
NUP224	120,000	215,000	40,000	5,57	19	NTN
NUP2240	200,000	360,000	98,000	41,30	19	NTN
NUP2240E	200,000	360,000	98,000	47,80	19	NTN
NUP2244	220,000	400,000	108,000	59,00	19	NTN
NUP2248	240,000	440,000	120,000	80,00	19	NTN
NUP224E	120,000	215,000	40,000	5,97	19	NTN
NUP2252	260,000	480,000	130,000	104,00	19	NTN
NUP2256	280,000	500,000	130,000	109,00	19	NTN
NUP226	130,000	230,000	40,000	6,30	19	NTN
NUP2260	300,000	540,000	140,000	138,00	19	NTN
NUP2264	320,000	580,000	150,000	172,00	19	NTN
NUP226E	130,000	230,000	40,000	6,90	19	NTN
NUP228	140,000	250,000	42,000	7,88	19	NTN
NUP228E	140,000	250,000	42,000	8,73	19	NTN
NUP230	150,000	270,000	45,000	9,92	19	NTN
NUP2304E	20,000	52,000	21,000	0,24	19	NTN
NUP2305E	25,000	62,000	24,000	0,39	19	NTN
NUP2306E	30,000	72,000	27,000	0,58	19	NTN
NUP2307	35,000	80,000	31,000	0,69	19	NTN
NUP2307E	35,000	80,000	31,000	0,78	19	NTN
NUP2308	40,000	90,000	33,000	0,95	19	NTN
NUP2308E	40,000	90,000	33,000	1,06	19	NTN
NUP2309	45,000	100,000	36,000	1,27	19	NTN
NUP2309E	45,000	100,000	36,000	1,41	19	NTN
NUP230E	150,000	270,000	45,000	11,00	19	NTN
NUP2310	50,000	110,000	40,000	1,70	19	NTN
NUP2310E	50,000	110,000	40,000	1,90	19	NTN
NUP2311	55,000	120,000	43,000	2,17	19	NTN
NUP2311E	55,000	120,000	43,000	2,37	19	NTN
NUP2312	60,000	130,000	46,000	2,71	19	NTN
NUP2312E	60,000	130,000	46,000	2,96	19	NTN
NUP2313	65,000	140,000	48,000	3,27	19	NTN

Reference	d	D	B	Kg	?	Brands
NUP2313E	65,000	140,000	48,000	3,48	19	NTN
NUP2314	70,000	150,000	51,000	3,98	19	NTN
NUP2314E	70,000	150,000	51,000	4,25	19	NTN
NUP2315	75,000	160,000	55,000	4,87	19	NTN
NUP2315E	75,000	160,000	55,000	5,25	19	NTN
NUP2316	80,000	170,000	58,000	6,15	19	NTN
NUP2316E	80,000	170,000	58,000	6,25	19	NTN
NUP2317	85,000	180,000	60,000	6,70	19	NTN
NUP2317E	85,000	180,000	60,000	7,16	19	NTN
NUP2318	90,000	190,000	64,000	7,95	19	NTN
NUP2318E	90,000	190,000	64,000	8,56	19	NTN
NUP2319	95,000	200,000	67,000	9,20	19	NTN
NUP2319E	95,000	200,000	67,000	9,80	19	NTN
NUP232	160,000	290,000	48,000	13,70	19	NTN
NUP2320	100,000	215,000	73,000	11,70	19	NTN
NUP2320E	105,000	215,000	73,000	12,80	19	NTN
NUP2322	110,000	240,000	80,000	17,10	19	NTN
NUP2322E	110,000	240,000	80,000	19,40	19	NTN
NUP2324	120,000	260,000	86,000	21,50	19	NTN
NUP2324E	120,000	260,000	86,000	26,10	19	NTN
NUP2326	130,000	280,000	93,000	26,90	19	NTN
NUP2326E	130,000	280,000	93,000	30,90	19	NTN
NUP2328	140,000	300,000	102,000	33,80	19	NTN
NUP2328E	140,000	300,000	102,000	38,70	19	NTN
NUP232E	160,000	290,000	48,000	15,60	19	NTN
NUP2330	150,000	320,000	108,000	40,60	19	NTN
NUP2330E	150,000	320,000	108,000	47,20	19	NTN
NUP2332	160,000	340,000	114,000	50,50	19	NTN
NUP2332E	160,000	340,000	114,000	56,00	19	NTN
NUP2334	170,000	360,000	120,000	59,50	19	NTN
NUP2336	180,000	380,000	126,000	69,50	19	NTN
NUP2338	190,000	400,000	132,000	80,50	19	NTN
NUP234	170,000	310,000	52,000	17,00	19	NTN
NUP2340	200,000	420,000	138,000	92,60	19	NTN
NUP2344	220,000	460,000	145,000	116,00	19	NTN
NUP2348	240,000	500,000	155,000	147,00	19	NTN
NUP234E	170,000	310,000	52,000	19,60	19	NTN
NUP2352	260,000	540,000	165,000	182,00	19	NTN
NUP2356	280,000	580,000	175,000	222,00	19	NTN
NUP236	180,000	320,000	52,000	17,70	19	NTN
NUP236E	180,000	320,000	52,000	20,40	19	NTN
NUP238	190,000	340,000	55,000	21,30	19	NTN
NUP238E	190,000	340,000	55,000	24,20	19	NTN
NUP240	200,000	360,000	58,000	25,30	19	NTN
NUP240E	200,000	360,000	58,000	28,10	19	NTN
NUP244	220,000	400,000	65,000	37,70	19	NTN
NUP248	240,000	440,000	72,000	50,20	19	NTN
NUP252	260,000	480,000	80,000	66,90	19	NTN
NUP256	280,000	500,000	80,000	70,80	19	NTN
NUP260	300,000	540,000	85,000	88,20	19	NTN
NUP264	320,000	580,000	92,000	111,00	19	NTN
NUP29/1180	1 180,000	1 540,000	206,000	1 090,00	19	NTN

Reference	d	D	B	Kg	?	Brands
NUP304	20,000	52,000	15,000	0,16	19	NTN
NUP304E	20,000	52,000	15,000	0,18	19	NTN
NUP305	25,000	62,000	17,000	0,24	19	NTN
NUP305E	25,000	62,000	17,000	0,28	19	NTN
NUP 305 EG15	25,000	62,000	17,000	0,25	19	SNR
NUP306	30,000	72,000	19,000	0,37	19	NTN
NUP306E	30,000	72,000	19,000	0,40	19	NTN
NUP 306 EG15	30,000	72,000	19,000	0,37	19	SNR
NUP307	35,000	80,000	21,000	0,50	19	NTN
NUP307E	35,000	80,000	21,000	0,55	19	NTN
NUP 307 EG15	35,000	80,000	21,000	0,51	19	SNR
NUP307E.J	35,000	80,000	21,000	0,55	19	NTN
NUP308	40,000	90,000	23,000	0,69	19	NTN
NUP308E	40,000	90,000	23,000	0,75	19	NTN
NUP 308 EG15	40,000	90,000	23,000	0,68	19	SNR
NUP309	45,000	100,000	25,000	0,88	19	NTN
NUP309E	45,000	100,000	25,000	1,00	19	NTN
NUP 309 EG15	45,000	100,000	25,000	0,92	19	SNR
NUP310	50,000	110,000	27,000	1,19	19	NTN
NUP310E	50,000	110,000	27,000	1,30	19	NTN
NUP 310 EG15	50,000	110,000	27,000	1,21	19	SNR
NUP311	55,000	120,000	29,000	1,51	19	NTN
NUP311E	55,000	120,000	29,000	1,65	19	NTN
NUP 311 EG15	55,000	120,000	29,000	1,53	19	SNR
NUP312	60,000	130,000	31,000	1,87	19	NTN
NUP312E	60,000	130,000	31,000	2,05	19	NTN
NUP 312 EG15	60,000	130,000	31,000	1,91	19	SNR
NUP313	65,000	140,000	33,000	2,30	19	NTN
NUP313E	65,000	140,000	33,000	2,54	19	NTN
NUP314	70,000	150,000	35,000	2,66	19	NTN
NUP314E	70,000	150,000	35,000	3,10	19	NTN
NUP315	75,000	160,000	37,000	3,28	19	NTN
NUP315E	75,000	160,000	37,000	3,74	19	NTN
NUP315E/55	55,000	160,000	37,000	4,26	19	NTN
NUP316	80,000	170,000	39,000	3,86	19	NTN
NUP316E	80,000	170,000	39,000	4,22	19	NTN
NUP 316 EG15	80,000	170,000	39,000	4,11	19	SNR
NUP317	85,000	180,000	41,000	4,78	19	NTN
NUP317E	85,000	180,000	41,000	5,10	19	NTN
NUP 317 EG15	85,000	180,000	41,000	4,76	19	SNR
NUP318	90,000	190,000	43,000	5,30	19	NTN
NUP318E	90,000	190,000	43,000	5,72	19	NTN
NUP319	95,000	200,000	45,000	6,13	19	NTN
NUP319E	95,000	200,000	45,000	6,62	19	NTN
NUP320	100,000	215,000	47,000	7,49	19	NTN
NUP320E	100,000	215,000	47,000	8,57	19	NTN
NUP321	105,000	225,000	49,000	8,53	19	NTN
NUP322	110,000	240,000	50,000	10,70	19	NTN
NUP322E	110,000	240,000	50,000	11,10	19	NTN
NUP324	120,000	260,000	55,000	13,60	19	NTN
NUP324E	120,000	260,000	55,000	13,90	19	NTN
NUP326	130,000	280,000	58,000	17,40	19	NTN

Reference	d	D	B	Kg	?	Brands
NUP326E	130,000	280,000	58,000	19,40	19	NTN
NUP328	140,000	300,000	62,000	21,20	19	NTN
NUP328E	140,000	300,000	62,000	23,20	19	NTN
NUP330	150,000	320,000	65,000	25,30	19	NTN
NUP330E	150,000	320,000	65,000	28,40	19	NTN
NUP332	160,000	340,000	68,000	31,30	19	NTN
NUP332E	160,000	340,000	68,000	34,00	19	NTN
NUP334	170,000	360,000	72,000	37,00	19	NTN
NUP336	180,000	380,000	75,000	44,20	19	NTN
NUP338	190,000	400,000	78,000	49,40	19	NTN
NUP340	200,000	420,000	80,000	55,80	19	NTN
NUP344	220,000	460,000	88,000	73,40	19	NTN
NUP348	240,000	500,000	95,000	93,40	19	NTN
NUP352	260,000	540,000	102,000	117,00	19	NTN
NUP356	280,000	580,000	108,000	142,00	19	NTN
NUP405	25,000	80,000	21,000	0,55	19	NTN
NUP406	30,000	90,000	23,000	0,75	19	NTN
NUP407	35,000	100,000	25,000	0,99	19	NTN
NUP408	40,000	110,000	27,000	1,30	19	NTN
NUP409	45,000	120,000	29,000	1,62	19	NTN
NUP410	50,000	130,000	31,000	2,02	19	NTN
NUP411	55,000	140,000	33,000	2,48	19	NTN
NUP412	60,000	150,000	35,000	3,00	19	NTN
NUP413	65,000	160,000	37,000	3,60	19	NTN
NUP414	70,000	180,000	42,000	5,24	19	NTN
NUP415	75,000	190,000	45,000	6,22	19	NTN
NUP416	80,000	200,000	48,000	7,32	19	NTN
R0534V	25,000	52,000	20,600	0,21	17	NTN
R0608	32,000	68,000	30,000	0,47	17	NTN
R0638	30,000	62,000	27,000	0,31	17	NTN
R0679V	32,000	90,000	23,000	0,81	17	NTN
R0684	30,000	73,000	26,000	0,45	17	NTN
R0686	32,000	65,000	30,000	0,38	17	NTN
R0688	32,000	68,000	30,000	0,47	17	NTN
R0694V	30,000	80,000	23,000	0,61	17	NTN
R06A02	30,000	57,000	27,000	0,25	17	NTN
R06A49	32,000	68,000	30,000	0,47	17	NTN
R06A65	32,000	68,000	30,000	0,47	17	NTN
R06A68V	28,737	57,000	18,000	0,20	17	NTN
R06A70	32,000	73,500	38,000	0,74	17	NTN
R06A72	30,000	56,000	30,000	0,27	17	NTN
R06A79	32,000	65,000	30,000	0,39	17	NTN
R06B09V	28,816	57,000	18,000	0,19	17	NTN
R06B13	32,000	68,000	30,000	0,54	17	NTN
R06B26V	30,000	88,860	17,000	1,41	17	NTN
R06B32	32,000	68,000	30,000	0,54	17	NTN
R06B35V	30,000	88,860	17,000	1,41	17	NTN
R0725V	35,000	72,000	20,600	0,39	17	NTN
R0733V	35,000	90,000	23,000	0,74	17	NTN
R0739	35,000	80,000	31,000	0,56	17	NTN
R0781D2	35,000	67,000	52,000	0,72	17	NTN
R0782D2	36,000	72,000	60,000	1,01	17	NTN



Reference	d	D	B	Kg	Brands
R0788ZA	35,000	72,000	24,000	0,41	17 NTN
R07A17	35,000	68,000	30,000	0,44	17 NTN
R07A23V	35,000	90,000	23,000	0,75	17 NTN
R07A54V	35,110	66,000	16,700	0,23	17 NTN
R07A57V	35,000	88,860	17,000	1,38	17 NTN
R07A67V	35,110	67,000	19,600	0,35	17 NTN
R07A68V	35,110	67,000	19,450	0,35	17 NTN
R07A69V	35,110	67,000	19,450	0,29	17 NTN
R07A70V	35,110	66,000	16,700	0,000	17 NTN
R07A72V	35,000	88,860	17,000	1,38	17 NTN
R0868	40,000	62,000	20,000	0,19	17 NTN
R0876	40,000	73,530	30,000	0,45	17 NTN
R0878VZZ	38,700	150,000	114,000	8,80	17 NTN
R0895	38,000	70,000	35,000	0,50	17 NTN
R0897	42,000	120,000	41,000	1,91	17 NTN
R08A08VZZ	40,000	140,000	55,000	4,22	17 NTN
R08A17D2	38,000	77,000	72,000	1,36	17 NTN
R08A20	40,000	75,000	28,000	0,44	17 NTN
R08A31V	38,400	150,000	138,000	12,50	17 NTN
R08A45	40,000	73,526	32,500	0,49	17 NTN
R08A58V	40,000	90,000	28,000	1,19	17 NTN
R08A70	38,000	70,000	35,000	0,50	17 NTN
R08A92VZZ	38,300	150,000	138,000	11,01	17 NTN
R1031	50,000	120,000	87,000	4,47	17 NTN
R1033V	50,000	80,000	20,000	0,37	17 NTN
R1040	50,000	80,000	23,000	0,39	17 NTN
R10405K	521,333	800,000	100,000	188,00	17 NTN
R1041	50,000	72,100	16,000	0,19	17 NTN
R1062D2	50,000	96,000	80,000	2,29	17 NTN
R1063	47,550	70,630	27,000	0,31	17 NTN
R1099V	50,000	156,000	70,000	8,00	17 NTN
R10A02	49,500	120,000	60,000	1,86	17 NTN
R1131	55,000	85,000	23,000	0,42	17 NTN
R1167D2	55,000	106,000	92,000	3,19	17 NTN
R11A06VLL	56,000	160,000	63,000	7,22	17 NTN
R11A11V	55,000	90,000	32,000	0,70	17 NTN
R12001	600,000	800,000	90,000	109,00	17 NTN
R1222	60,511	90,000	20,000	0,40	17 NTN
R1232	60,000	90,000	23,000	0,45	17 NTN
R1242	60,000	110,000	35,000	1,15	17 NTN
R1275VZZ	58,000	160,000	70,000	7,40	17 NTN
R1344LL	65,000	140,000	100,000	6,54	17 NTN
R1424	70,000	160,000	95,000	4,53	17 NTN
R1425	70,000	125,000	24,000	1,10	17 NTN
R1431	70,000	110,000	28,000	0,93	17 NTN
R1453V	70,000	178,000	60,000	8,60	17 NTN
R1462VZ	68,000	175,000	75,000	8,42	17 NTN
R1564V	75,000	130,000	31,000	1,48	17 NTN
R1619	80,000	120,000	31,000	1,12	17 NTN
R1743	85,000	200,000	101,000	8,04	17 NTN
R1778V	58,052	147,380	65,532	4,42	17 NTN
R1845LL	90,000	160,000	112,000	8,47	17 NTN

Reference	d	D	B	Kg	Brands
R1919	95,250	140,000	66,670	3,24	17 NTN
R2009	100,000	215,000	82,550	14,90	17 NTN
R2039	100,000	240,000	107,000	13,40	17 NTN
R2049	100,000	180,000	60,000	6,92	17 NTN
R2221	110,000	200,000	69,850	9,84	17 NTN
R2227	110,000	265,000	110,000	27,60	17 NTN
R2230	110,000	265,000	110,000	17,10	17 NTN
R2238V	110,000	150,000	24,000	1,20	17 NTN
R2260V	110,000	170,000	60,000	4,30	17 NTN
R2264HTV	110,000	180,000	69,000	6,00	17 NTN
R2494	120,000	180,000	46,000	4,30	17 NTN
R2514	126,987	215,900	61,912	9,75	17 NTN
R2515	126,873	215,900	61,913	10,30	17 NTN
R2625	130,000	230,000	80,000	14,70	17 NTN
R2635	130,000	305,000	150,000	29,20	17 NTN
R2645V	130,000	180,000	30,000	2,30	17 NTN
R2674	130,000	200,000	69,000	8,39	17 NTN
R2675HTV	130,000	210,000	80,000	9,30	17 NTN
R2812	140,000	250,000	82,550	17,80	17 NTN
R2841V	140,000	190,000	30,000	2,51	17 NTN
R2856	140,000	250,000	68,000	15,30	17 NTN
R2869V	140,000	210,000	69,000	9,37	17 NTN
R3025V	150,000	320,000	123,825	50,31	17 NTN
R3062V	150,000	225,000	75,000	11,70	17 NTN
R3063HTV	150,000	225,000	75,000	11,20	17 NTN
R3230	160,000	240,000	60,000	8,29	17 NTN
R3263HTV	160,000	240,000	80,000	1,80	17 NTN
R3402	670,000	900,000	200,000	330,00	17 NTN
R3428V	170,000	230,000	36,000	4,24	17 NTN
R3431K30	170,000	295,000	137,000	21,00	17 NTN
R3451K30	170,000	295,000	180,000	25,50	17 NTN
R3624	180,000	280,000	74,000	15,90	17 NTN
R3819V	190,000	260,000	42,000	6,55	17 NTN
R4032K	200,000	360,000	98,000	40,00	17 NTN
R4046	200,000	310,000	109,000	32,30	17 NTN
R4056	200,000	420,000	165,000	120,00	17 NTN
R4207	210,000	290,000	45,000	8,20	17 NTN
R4208	210,000	290,000	70,000	17,50	17 NTN
R4416V	220,000	300,000	48,000	9,84	17 NTN
R4803	1 210,000	1 380,000	97,000	206,00	17 NTN
R4808V	240,000	320,000	48,000	10,40	17 NTN
R5213V	260,000	360,000	60,000	18,70	17 NTN
R5501	277,000	385,000	65,000	22,90	17 NTN
R5608V	280,000	380,000	60,000	17,10	17 NTN
R6410V	320,000	440,000	72,000	28,40	17 NTN
R71055	355,600	495,300	208,000	90,00	17 NTN
R7207	360,000	650,000	170,000	245,00	17 NTN
R8803	1 440,000	1 580,000	97,000	237,00	17 NTN
R9605	480,000	650,000	78,000	64,70	17 NTN
RE2512	127,000	254,000	114,300	26,90	17 NTN
RE3036V	150,000	255,000	169,000	30,50	17 NTN
RE6405	320,000	622,300	268,000	330,00	17 NTN

Reference	d	D	B	Kg		Brands
RN10005	500,000	600,000	46,000	23,60	17	NTN
RN1413	69,850	104,770	17,460	0,51	17	NTN
RN14205	710,000	900,000	112,000	172,00	17	NTN
RN233	160,000	290,000	75,000	22,40	17	NTN
RN2820	140,000	220,000	36,000	4,24	17	NTN
RN3032	150,000	210,000	62,000	4,85	17	NTN
RN3813NA	190,000	280,000	90,000	18,00	17	NTN
RN4022	200,000	320,000	48,000	46,16	17	NTN
RN5609	280,000	460,000	123,800	84,00	17	NTN
RN5804	292,100	387,350	66,670	18,60	17	NTN
RN58042	292,100	387,350	66,670	18,60	17	NTN
RN629	177,800	260,350	63,500	10,99	17	NTN
RN6407	320,000	520,000	176,000	128,00	17	NTN
RN6502	323,850	444,500	85,725	40,70	17	NTN
RN8005	400,000	500,000	46,000	19,20	17	NTN
RNF1908	95,000	220,000	67,000	13,09	22	NTN
RNF1923	95,000	219,000	67,000	12,90	22	NTN
RNF2206	110,000	260,000	92,000	25,80	22	NTN
RNF2223	110,000	260,325	92,000	25,60	22	NTN
RNF2804	140,000	300,000	114,000	43,38	22	NTN
RNF2826	140,000	300,000	114,000	43,38	22	NTN
RNF6404	320,000	500,000	71,000	53,70	22	NTN
RNH1017	85,000	118,500	22,000	0,59	21	NTN
RNH213	65,000	105,600	23,000	0,65	21	NTN
RNH2313	65,000	124,500	96,000	4,53	21	NTN
RNJ0522V	24,000	52,000	16,000	0,16	18	NTN
RNJ0537	25,000	52,000	15,500	0,15	18	NTN
RNJ0620	30,000	72,000	23,500	0,45	18	NTN
RNJ0626	30,000	72,000	26,800	0,52	18	NTN
RNJ0916V	45,000	100,000	32,000	1,14	18	NTN
RNJ0922	45,000	85,000	23,000	0,57	18	NTN
RNJ1224	59,588	125,000	33,300	1,92	18	NTN
RNJ1419	70,000	150,000	56,000	4,41	18	NTN
RNJ1517	75,000	160,000	60,000	5,55	18	NTN
RNJ1610	80,000	170,000	65,000	7,13	18	NTN
RNJ17002	850,000	1 050,000	125,000	245,00	18	NTN
RNJ1733	85,000	150,000	40,000	2,90	18	NTN
RNJ2304	115,000	250,000	53,000	12,80	18	NTN
RNJ3215	158,750	285,648	63,500	16,60	18	NTN
RNJ4103	203,200	273,050	41,275	6,36	18	NTN
RNJ6901	342,900	457,200	57,150	27,40	18	NTN
RNN10005	500,000	800,000	350,000	690,00	24	NTN
RNN13602	680,000	840,000	180,000	216,00	24	NTN
RNN2823K	140,000	210,000	63,000	7,03	24	NTN
RNN3025	150,000	210,000	70,000	7,17	24	NTN
RNN3215	160,000	250,000	70,000	12,30	24	NTN
RNN3611	180,000	252,000	110,000	16,20	24	NTN
RNN4207K	210,000	290,000	80,000	15,10	24	NTN
RNN4410	220,000	460,000	176,000	159,00	24	NTN
RNN4411	220,000	310,000	110,000	29,70	24	NTN
RNN4411K	220,000	310,000	110,000	29,50	24	NTN
RNN4805	240,000	500,000	250,000	219,00	24	NTN

Reference	d	D	B	Kg		Brands
RNN5208K	260,000	400,000	110,000	46,60	24	NTN
RNN5610	280,000	560,000	300,000	354,80	24	NTN
RNN6011	300,000	430,000	165,000	76,30	24	NTN
RNNJ5208DF	260,000	540,000	382,000	421,00	24	NTN
RNNJ6001DF	300,000	540,000	350,000	360,00	24	NTN
RNNU10024	500,000	720,000	270,000	360,00	24	NTN
RNNU10407	520,000	640,000	175,000	112,40	24	NTN
RNNU11207	560,000	740,000	240,000	280,00	24	NTN
RNNU11208	560,000	735,000	170,000	220,00	24	NTN
RNNU11501	575,000	950,000	270,000	807,00	24	NTN
RNNU11601	580,000	680,000	110,000	65,70	24	NTN
RNNU12203	610,000	850,000	290,000	516,00	24	NTN
RNNU13404	670,000	1 150,000	380,000	1 570,00	24	NTN
RNNU3421	170,000	310,000	172,000	57,20	24	NTN
RNNU4421	220,000	460,000	180,000	154,00	24	NTN
RNNU5217	260,000	540,000	230,000	235,00	24	NTN
RNNU5218	260,000	320,000	145,000	49,60	24	NTN
RNNU5503	273,000	510,000	300,000	278,00	24	NTN
RNNU5609	280,000	400,000	150,000	59,40	24	NTN
RNNU5804	290,000	510,000	260,000	233,00	24	NTN
RNNU6414	320,000	480,000	175,000	110,00	24	NTN
RNNU7205	360,000	500,000	125,000	81,00	24	NTN
RNNU8016	400,000	655,000	285,000	396,00	24	NTN
RNNU8413	420,000	760,000	280,000	558,00	24	NTN
RNNU9103	457,200	660,400	228,600	236,00	24	NTN
RNNU9606	480,000	680,000	250,000	295,00	24	NTN
RNP2032	100,000	180,000	60,000	7,19	19	NTN
RNU0314ZZ	17,000	40,000	18,000	0,12	17	NTN
RNU0627	28,000	62,000	25,000	0,35	17	NTN
RNU0917	45,000	120,000	42,000	2,56	17	NTN
RNU10010	500,000	900,000	210,000	598,00	17	NTN
RNU1145	55,000	100,000	54,102	1,77	17	NTN
RNU11601	580,000	780,000	100,000	140,00	17	NTN
RNU11604	580,000	1 070,000	220,000	965,00	17	NTN
RNU1423ZZA	70,000	150,000	40,000	3,04	17	NTN
RNU14801	740,000	1 000,000	115,000	264,00	17	NTN
RNU1610	80,000	170,000	57,000	6,10	17	NTN
RNU1625	80,000	140,000	33,000	1,88	17	NTN
RNU1636	80,000	140,000	66,680	4,68	17	NTN
RNU16602	830,000	1 090,000	115,000	285,00	17	NTN
RNU16603	830,000	1 040,000	115,000	219,00	17	NTN
RNU16604	830,000	1 090,000	115,000	281,00	17	NTN
RNU1744	85,000	150,000	36,000	2,02	17	NTN
RNU1749	85,000	150,000	125,000	8,80	17	NTN
RNU 203 EG15	22,100	40,000	12,000	0,05	17	SNR
RNU 204 EG15	26,500	47,000	14,000	0,09	17	SNR
RNU 205 EG15	31,500	52,000	15,000	0,10	17	SNR
RNU2062	101,600	152,400	101,600	6,27	17	NTN
RNU2068	101,600	180,000	210,000	21,80	17	NTN
RNU2074	100,000	215,000	73,000	9,20	17	NTN
RNU2223	110,000	200,000	69,850	9,96	17	NTN
RNU2226	110,000	200,000	88,900	13,10	17	NTN



Reference	d	D	B	Kg		Brands
RNU2238	109,692	160,020	83,820	3,12	17	NTN
RNU2243	110,000	200,000	54,000	7,11	17	NTN
RNU2313	114,300	200,000	220,000	27,84	17	NTN
RNU2421	120,000	215,000	98,425	14,72	17	NTN
RNU2514	125,000	230,000	120,000	16,90	17	NTN
RNU2622	130,000	230,000	79,375	14,50	17	NTN
RNU2654	130,000	280,000	94,000	27,16	17	NTN
RNU3066	150,000	270,000	125,000	19,70	17	NTN
RNU3216	160,000	290,000	98,425	30,00	17	NTN
RNU3415	170,000	310,000	104,770	36,00	17	NTN
RNU3430	170,000	280,000	145,000	23,72	17	NTN
RNU3431	170,000	280,000	185,000	26,25	17	NTN
RNU3629	177,800	260,350	63,500	10,99	17	NTN
RNU3653	177,800	320,000	193,000	64,19	17	NTN
RNU3658K	180,000	320,000	126,000	31,70	17	NTN
RNU3819	190,000	340,000	114,300	45,60	17	NTN
RNU3820	190,500	340,000	190,500	56,90	17	NTN
RNU3823	190,000	340,000	275,000	94,40	17	NTN
RNU3824	190,000	340,000	220,000	75,50	17	NTN
RNU3840	190,000	300,000	85,725	24,10	17	NTN
RNU3842	190,000	300,000	85,725	21,40	17	NTN
RNU4036	200,000	420,000	140,000	82,50	17	NTN
RNU4046	200,000	360,000	104,000	42,90	17	NTN
RNU4203	210,000	380,000	127,000	63,30	17	NTN
RNU4302	215,900	355,600	79,375	29,80	17	NTN
RNU4423	220,000	400,000	133,350	64,30	17	NTN
RNU4424	220,000	350,000	98,425	37,00	17	NTN
RNU4614	230,000	400,000	108,000	57,10	17	NTN
RNU4702	234,950	327,025	114,300	27,79	17	NTN
RNU4804	240,000	440,000	146,050	93,32	17	NTN
RNU4807	240,000	500,000	157,000	130,00	17	NTN
RNU4817	240,000	440,000	146,000	101,00	17	NTN
RNU5209	260,000	540,000	167,000	162,00	17	NTN
RNU5214	260,000	480,000	150,000	105,00	17	NTN
RNU5215	260,000	480,000	158,800	131,00	17	NTN
RNU5216	260,000	480,000	158,800	135,00	17	NTN
RNU5311	266,700	406,400	139,700	67,30	17	NTN
RNU5617	280,000	500,000	165,100	150,00	17	NTN
RNU5619	280,000	500,000	165,100	148,00	17	NTN
RNU5623	280,000	500,000	165,100	146,00	17	NTN
RNU5804	292,100	387,350	50,800	15,50	17	NTN
RNU6028	300,000	540,000	177,800	182,00	17	NTN
RNU6407	320,000	670,000	202,000	302,00	17	NTN
RNU6411	320,000	580,000	160,000	196,00	17	NTN
RNU6416	320,000	580,000	160,000	196,00	17	NTN
RNU6422	320,000	580,000	190,500	210,00	17	NTN
RNU6424	320,000	580,000	160,000	192,00	17	NTN
RNU6805	340,000	600,000	170,000	225,00	17	NTN
RNU6808	340,000	590,000	210,000	235,00	17	NTN
RNU7203	360,000	650,000	172,000	218,00	17	NTN
RNU7205	360,000	610,000	210,000	250,00	17	NTN
RNU7611	380,000	680,000	177,000	295,00	17	NTN

Reference	d	D	B	Kg		Brands
RNU8005	400,000	720,000	187,000	290,00	17	NTN
RNU8102	405,000	730,000	195,000	335,00	17	NTN
RNU9211	460,000	820,000	200,000	466,00	17	NTN
RNU9403	470,000	870,000	210,000	563,00	17	NTN
RNUJ1215	60,000	130,000	54,000	3,40	18	NTN
RNUJ1610	80,000	170,000	68,000	6,66	18	NTN
RNUJ2033	100,000	215,000	85,000	14,50	18	NTN
RNUJ2224	110,000	240,000	93,000	18,80	18	NTN
RNUP0527	25,000	52,000	20,600	0,19	19	NTN
RNUP0626	30,000	82,000	20,000	0,61	19	NTN
RNUP0709V	35,000	72,000	19,000	0,36	19	NTN
RNUP0913V	45,000	100,000	25,000	1,03	19	NTN
RNUP1012	50,000	110,000	44,400	2,30	19	NTN
RNUP1016V	50,000	110,000	32,000	1,44	19	NTN
RNUP1019V	50,000	110,000	32,000	1,55	19	NTN
RNUP1022V	50,000	110,000	35,500	0,000	19	NTN
RNUP1115V	55,000	130,000	31,000	2,24	19	NTN
RNUP1117V	55,000	120,000	34,000	1,77	19	NTN
RNUP1123V	55,000	130,000	36,700	2,39	19	NTN
RNUP1125V	55,000	100,000	31,000	1,04	19	NTN
RNUP1216V	60,000	130,000	38,700	2,29	19	NTN
RNUP1323	65,000	160,000	43,550	4,29	19	NTN
RNUP1324	65,000	160,000	43,550	4,29	19	NTN
RNUP1325	65,000	120,000	33,000	1,68	19	NTN
RNUP1327	67,000	122,000	35,000	1,87	19	NTN
RNUP13301	663,800	740,000	38,100	21,20	19	NTN
RNUP1418	70,000	150,000	35,000	3,05	19	NTN
RNUP1425	70,000	150,000	43,100	0,000	19	NTN
RNUP1517	66,000	160,000	45,528	3,96	19	NTN
RNUP1611	80,000	170,000	44,290	0,000	19	NTN
RNUP1734	85,000	150,000	42,000	3,15	19	NTN
RR0407	20,000	26,955	37,000	0,07	24	NTN
RR0830	39,000	78,500	34,000	0,71	24	NTN
RR2904	145,000	285,000	124,000	13,10	24	NTN
RT0913	45,000	100,000	31,000	1,07	36	NTN
RT10802	540,000	705,000	100,000	98,50	36	NTN
RT11704	580,000	670,000	54,000	31,00	36	NTN
RT13001	650,000	780,000	100,000	80,30	36	NTN
RT13004	650,000	730,000	57,000	29,00	36	NTN
RT15207	760,000	840,000	57,000	34,15	36	NTN
RT16005	800,000	950,000	90,000	120,00	36	NTN
RT18003	900,000	1 060,000	130,000	220,00	36	NTN
RT19008	945,000	1 055,000	60,000	67,00	36	NTN
RT32503	1 600,000	1 795,000	111,000	380,00	36	NTN
RT3615	180,000	220,000	22,000	2,10	36	NTN
RT4411	220,000	270,000	25,000	4,30	36	NTN
RT6405	320,000	380,000	30,000	8,40	36	NTN
RT8010	400,000	540,000	112,000	79,70	36	NTN
RTD5803	290,000	420,000	120,000	60,00	36	NTN
RUS1007	42,000	62,000	14,000	0,12	23	NTN
RUS1013	74,500	100,000	18,000	0,37	23	NTN
RUS203	22,900	40,000	12,000	0,05	23	NTN

Reference	d	D	B	Kg		Brands
RUS204	27,000	47,000	14,000	0,08	23	NTN
RUS204E	27,000	47,000	14,000	0,08	23	NTN
RUS205	25,000	52,000	15,000	0,10	23	NTN
RUS205E	25,000	52,000	15,000	0,10	23	NTN
RUS206E/60	37,500	60,000	16,000	0,13	23	NTN
RUS206EJC	37,500	62,000	16,000	0,16	23	NTN
RUS207	47,600	72,000	17,000	0,22	23	NTN
RUS207E	44,000	72,000	17,000	0,24	23	NTN
RUS208	50,000	80,000	18,000	0,28	23	NTN
RUS208E	49,500	80,000	18,000	0,28	23	NTN
RUS210	60,400	90,000	20,000	0,35	23	NTN
RUS210E	59,500	90,000	20,000	0,35	23	NTN
RUS212	73,500	110,000	22,000	0,60	23	NTN
RUS212E	72,000	110,000	22,000	0,59	23	NTN
RUS214E	83,500	125,000	24,000	1,08	23	NTN
RUS2205E	31,500	52,000	18,000	0,14	23	NTN
RUS2206E	37,500	62,000	20,000	0,26	23	NTN
RUS2207	43,800	72,000	23,000	0,33	23	NTN
RUS2207ED3	44,000	72,000	69,000	0,99	23	NTN
RUS2208	50,000	80,000	23,000	0,47	23	NTN
RUS2209	55,000	85,000	23,000	0,50	23	NTN
RUS2211	66,500	100,000	25,000	0,61	23	NTN
RUS2213	79,600	120,000	31,000	1,06	23	NTN
RUS228	169,000	250,000	42,000	6,32	23	NTN
RUS2305E	34,000	62,000	24,000	0,26	23	NTN
RUS2310ED2	65,000	110,000	80,000	2,60	23	NTN
RUS2313ED2	82,500	140,000	96,000	5,05	23	NTN
RUS2314ED2	89,000	150,000	102,000	6,13	23	NTN
RUS304	28,500	52,000	15,000	0,11	23	NTN
RUS304E	28,500	52,000	15,000	0,12	23	NTN
RUS305	25,000	62,000	17,000	0,18	23	NTN
RUS305E	34,000	62,000	17,000	0,20	23	NTN
RUS306	42,000	72,000	19,000	0,26	23	NTN
RUS307	46,200	80,000	21,000	0,47	23	NTN
RUS307E	50,800	80,000	21,000	0,40	23	NTN
RUS308	53,500	90,000	23,000	0,48	23	NTN
RUS309E	58,500	100,000	25,000	0,86	23	NTN
RUS310	65,000	110,000	27,000	0,86	23	NTN
RUS310E	65,000	110,000	27,000	0,94	23	NTN
SL01-4830	150,000	190,000	40,000	2,74	26	NTN
SL01-4832	160,000	200,000	40,000	2,86	26	NTN
SL01-4834	170,000	215,000	45,000	4,10	26	NTN
SL01-4836	180,000	225,000	45,000	4,08	26	NTN
SL01-4838	190,000	240,000	50,000	5,65	26	NTN
SL01-4840	200,000	250,000	50,000	5,58	26	NTN
SL01-4844	220,000	270,000	50,000	6,40	26	NTN
SL01-4848	240,000	300,000	60,000	9,61	26	NTN
SL01-4852	260,000	320,000	60,000	11,00	26	NTN
SL01-4856	280,000	350,000	69,000	15,40	26	NTN
SL01-4860	300,000	380,000	80,000	23,00	26	NTN
SL01-4864	320,000	400,000	80,000	23,00	26	NTN
SL01-4868	340,000	420,000	80,000	25,60	26	NTN

Reference	d	D	B	Kg		Brands
SL01-4872	360,000	440,000	80,000	27,00	26	NTN
SL01-4876	380,000	480,000	100,000	45,30	26	NTN
SL01-4910	50,000	72,000	22,000	0,28	26	NTN
SL01-4910ZZ	50,000	72,000	22,000	0,29	26	NTN
SL01-4912	60,000	85,000	25,000	0,45	26	NTN
SL01-4912ZZ	60,000	85,000	25,000	0,47	26	NTN
SL01-4914	70,000	100,000	30,000	0,76	26	NTN
SL01-4914ZZ	70,000	100,000	30,000	0,79	26	NTN
SL01-4916	80,000	110,000	30,000	0,84	26	NTN
SL01-4916ZZ	80,000	110,000	30,000	0,88	26	NTN
SL01-4916ZZD2	80,000	110,000	60,000	1,77	26	NTN
SL01-4918	90,000	125,000	35,000	1,31	26	NTN
SL01-4920	100,000	140,000	40,000	1,90	26	NTN
SL01-4922	110,000	150,000	40,000	2,10	26	NTN
SL01-4924	120,000	165,000	45,000	2,95	26	NTN
SL01-4926	130,000	180,000	50,000	3,85	26	NTN
SL01-4928	140,000	190,000	50,000	4,20	26	NTN
SL01-4930	150,000	210,000	60,000	6,47	26	NTN
SL01-4932	160,000	220,000	60,000	7,00	26	NTN
SL01-4934	170,000	230,000	60,000	7,19	26	NTN
SL01-4936	180,000	250,000	69,000	10,70	26	NTN
SL01-4938	190,000	260,000	69,000	11,00	26	NTN
SL01-4940	200,000	280,000	80,000	15,70	26	NTN
SL01-4944	220,000	300,000	80,000	16,80	26	NTN
SL01-4948	240,000	320,000	80,000	18,40	26	NTN
SL01-4952	260,000	360,000	100,000	32,00	26	NTN
SL01-4956	280,000	380,000	100,000	33,90	26	NTN
SL01-4960	300,000	420,000	118,000	53,00	26	NTN
SL01-4964	320,000	440,000	118,000	56,00	26	NTN
SL01-4968	340,000	460,000	118,000	57,60	26	NTN
SL01-4972	360,000	480,000	118,000	62,00	26	NTN
SL01-4976	380,000	520,000	140,000	92,30	26	NTN
SL01-4980	400,000	540,000	140,000	96,40	26	NTN
SL01-4984	420,000	560,000	140,000	101,00	26	NTN
SL01-4988	440,000	600,000	160,000	139,00	26	NTN
SL02-4830	150,000	190,000	40,000	2,80	26	NTN
SL02-4832	160,000	200,000	40,000	2,85	26	NTN
SL02-4834	170,000	215,000	45,000	3,79	26	NTN
SL02-4836	180,000	225,000	45,000	4,15	26	NTN
SL02-4838	190,000	240,000	50,000	5,14	26	NTN
SL02-4840	200,000	250,000	50,000	5,39	26	NTN
SL02-4844	220,000	270,000	50,000	5,87	26	NTN
SL02-4848	240,000	300,000	60,000	9,42	26	NTN
SL02-4852	260,000	320,000	60,000	10,10	26	NTN
SL02-4856	280,000	350,000	69,000	15,00	26	NTN
SL02-4856D2	280,000	350,000	138,000	31,20	26	NTN
SL02-4860	300,000	380,000	80,000	21,30	26	NTN
SL02-4864	320,000	400,000	80,000	23,50	26	NTN
SL02-4868	340,000	420,000	80,000	24,80	26	NTN
SL02-4872	360,000	440,000	80,000	26,00	26	NTN
SL02-4876	380,000	480,000	100,000	44,00	26	NTN
SL02-4910	50,000	72,000	22,000	0,28	26	NTN



Reference	d	D	B	Kg		Brands
SL02-4912	60,000	85,000	25,000	0,44	26	NTN
SL02-4914	70,000	100,000	30,000	0,74	26	NTN
SL02-4916	80,000	110,000	30,000	0,83	26	NTN
SL02-4918	90,000	125,000	35,000	1,29	26	NTN
SL02-4920	100,000	140,000	40,000	1,90	26	NTN
SL02-4920D2	100,000	140,000	80,000	3,80	26	NTN
SL02-4922	110,000	150,000	40,000	2,06	26	NTN
SL02-4924	120,000	165,000	45,000	2,81	26	NTN
SL02-4926	130,000	180,000	50,000	3,75	26	NTN
SL02-4928	140,000	190,000	50,000	3,98	26	NTN
SL02-4930	150,000	210,000	60,000	6,26	26	NTN
SL02-4932	160,000	220,000	60,000	6,64	26	NTN
SL02-4934	170,000	230,000	60,000	7,02	26	NTN
SL02-4936	180,000	250,000	69,000	10,20	26	NTN
SL02-4936D2	180,000	250,000	138,000	20,40	26	NTN
SL02-4938	190,000	260,000	69,000	10,90	26	NTN
SL02-4940	200,000	280,000	80,000	15,10	26	NTN
SL02-4944	220,000	300,000	80,000	16,40	26	NTN
SL02-4948	240,000	320,000	80,000	17,90	26	NTN
SL02-4952	260,000	360,000	100,000	30,70	26	NTN
SL02-4956	280,000	380,000	100,000	33,10	26	NTN
SL02-4960	300,000	420,000	118,000	51,90	26	NTN
SL02-4964	320,000	440,000	118,000	54,90	26	NTN
SL02-4964D2	320,000	440,000	236,000	110,00	26	NTN
SL02-4968	340,000	460,000	118,000	57,80	26	NTN
SL02-4972	360,000	480,000	118,000	60,80	26	NTN
SL02-4976	380,000	520,000	140,000	90,50	26	NTN
SL02-4980	400,000	540,000	140,000	94,60	26	NTN
SL02-4984	420,000	560,000	140,000	98,60	26	NTN
SL02-4988	440,000	600,000	160,000	137,00	26	NTN
SL04-5008LLN	40,000	68,000	38,000	0,56	26	NTN
SL04-5008LLNR	40,000	68,000	38,000	0,56	26	NTN
SL04-5008NR	40,000	68,000	38,000	0,56	26	NTN
SL04-5009LLN	45,000	75,000	40,000	0,71	26	NTN
SL04-5009LLNR	45,000	75,000	40,000	0,71	26	NTN
SL04-5009NR	45,000	75,000	40,000	0,69	26	NTN
SL04-5010LLNR	50,000	80,000	40,000	0,74	26	NTN
SL04-5010NR	50,000	80,000	40,000	0,76	26	NTN
SL04-5011LLNR	55,000	90,000	46,000	1,09	26	NTN
SL04-5011N	55,000	90,000	46,000	1,09	26	NTN
SL04-5011NR	55,000	90,000	46,000	1,17	26	NTN
SL04-5012LLNR	60,000	95,000	46,000	1,25	26	NTN
SL04-5012NR	60,000	95,000	46,000	1,25	26	NTN
SL04-5013LLNR	65,000	100,000	46,000	1,33	26	NTN
SL04-5013NR	65,000	100,000	46,000	1,27	26	NTN
SL04-5014LLNR	70,000	110,000	54,000	1,85	26	NTN
SL04-5014NR	70,000	110,000	54,000	1,87	26	NTN
SL04-5015LLNR	75,000	115,000	54,000	1,99	26	NTN
SL04-5015NR	75,000	115,000	54,000	1,97	26	NTN
SL04-5016LLNR	80,000	125,000	60,000	2,66	26	NTN
SL04-5016NR	80,000	125,000	60,000	2,66	26	NTN
SL04-5017LLNR	85,000	130,000	60,000	2,79	26	NTN

Reference	d	D	B	Kg		Brands
SL04-5017NR	85,000	130,000	60,000	2,78	26	NTN
SL04-5018LLNR	90,000	140,000	67,000	3,64	26	NTN
SL04-5018NR	90,000	140,000	67,000	3,71	26	NTN
SL04-5019LLNR	95,000	145,000	67,000	3,92	26	NTN
SL04-5019NR	95,000	145,000	67,000	3,94	26	NTN
SL04-5020LLNR	100,000	150,000	67,000	3,98	26	NTN
SL04-5020NR	100,000	150,000	67,000	3,98	26	NTN
SL04-5020ZNR	100,000	150,000	67,000	4,03	26	NTN
SL04-5022LLNR	110,000	170,000	80,000	6,52	26	NTN
SL04-5022NR	110,000	170,000	80,000	6,52	26	NTN
SL04-5024LLN	120,000	180,000	80,000	6,76	26	NTN
SL04-5024LLNR	120,000	180,000	80,000	7,12	26	NTN
SL04-5024N	120,000	180,000	80,000	6,90	26	NTN
SL04-5024NR	120,000	180,000	80,000	7,03	26	NTN
SL04-5026LLNR	130,000	200,000	95,000	10,60	26	NTN
SL04-5026N	130,000	200,000	95,000	10,40	26	NTN
SL04-5026NR	130,000	200,000	95,000	10,60	26	NTN
SL04-5028LLNR	140,000	210,000	95,000	11,30	26	NTN
SL04-5028NR	140,000	210,000	95,000	10,60	26	NTN
SL04-5030LLN	150,000	225,000	100,000	13,20	26	NTN
SL04-5030LLNR	150,000	225,000	100,000	13,60	26	NTN
SL04-5030NR	150,000	225,000	100,000	13,60	26	NTN
SL04-5032LLNR	160,000	240,000	109,000	16,80	26	NTN
SL04-5032NR	160,000	240,000	109,000	16,80	26	NTN
SL04-5034LLNR	170,000	260,000	122,000	23,10	26	NTN
SL04-5034NR	170,000	260,000	122,000	23,10	26	NTN
SL04-5036LLNR	180,000	280,000	136,000	32,30	26	NTN
SL04-5036NR	180,000	280,000	136,000	30,60	26	NTN
SL04-5038NR	190,000	290,000	136,000	31,70	26	NTN
SL04-5040NR	200,000	310,000	150,000	41,80	26	NTN
SL04-5044LLNR	220,000	340,000	160,000	53,80	26	NTN
SL04-5044NR	220,000	340,000	160,000	55,40	26	NTN
SL04-5048NR	240,000	360,000	160,000	57,80	26	NTN
SL04-5052N	260,000	400,000	190,000	89,36	26	NTN
SL04-5052NR	260,000	400,000	190,000	89,36	26	NTN
SL04-5056N	280,000	420,000	190,000	93,90	26	NTN
SL04-5056NR	280,000	420,000	190,000	93,90	26	NTN
SL04-5060NR	300,000	460,000	218,000	137,00	26	NTN
SL04-5064NR	320,000	480,000	218,000	144,00	26	NTN
SL04-5068	340,000	520,000	243,000	190,00	26	NTN
SL04-5068NR	340,000	520,000	243,000	194,00	26	NTN
SL04-5072NR	360,000	540,000	243,000	203,00	26	NTN
SL04-5076NR	380,000	560,000	243,000	212,00	26	NTN
SL04-5080NR	400,000	600,000	272,000	281,00	26	NTN
SL04-5084NR	420,000	620,000	272,000	292,00	26	NTN
SL04-5088NR	440,000	650,000	280,000	331,00	26	NTN
SL05-016	80,000	120,000	45,000	1,75	26	NTN
SL05-024	120,000	180,000	60,000	5,55	26	NTN
SL05-026	130,000	200,000	65,000	7,55	26	NTN
SL06-016	80,000	120,000	45,000	1,95	26	NTN
SL06-026	130,000	200,000	65,000	8,10	26	NTN
SL07-040	180,000	310,000	115,000	30,30	26	NTN

Reference	d	D	B	Kg		Brands
SL08-040	200,000	310,000	140,000	31,70	26	NTN
SL11-914	70,000	100,000	44,000	1,12	26	NTN
SL11-924	120,000	165,000	66,000	4,22	26	NTN
SL12-920	100,000	140,000	78,000	3,79	26	NTN
SL15-910D2	50,000	72,000	84,000	1,08	26	NTN
SL15-912D2	60,000	85,000	98,000	1,75	26	NTN
SL15-918	90,000	125,000	68,000	2,70	26	NTN
SL30X250X95	130,000	250,000	95,000	20,80	26	NTN
SLX130X200X114	130,000	200,000	113,000	12,40	26	NTN
SLX130X220X120	130,000	220,000	60,000	9,80	26	NTN
SLX130X220X150	130,000	220,000	150,000	13,70	26	NTN
SLX140X210X80	140,000	210,000	80,000	9,00	26	NTN
SLX150X225X124	150,000	225,000	123,000	16,40	26	NTN
SLX170X280X165	170,000	280,000	88,000	29,60	26	NTN
SLX170X280X88	170,000	280,000	88,000	29,60	26	NTN
SLX170X280X95	170,000	280,000	95,000	24,80	26	NTN
SLX180X240X80LL	180,000	240,000	80,000	9,42	26	NTN
SLX20X60X41	20,000	60,000	41,000	0,64	26	NTN
SLX220X370X125	220,000	370,000	125,000	59,05	26	NTN
SLX220X370X200	220,000	370,000	120,000	65,40	26	NTN
SLX240X390X130	240,000	390,000	130,000	65,70	26	NTN
SLX240X390X200	240,000	390,000	200,000	71,40	26	NTN
SLX260X440X145	260,000	440,000	145,000	87,70	26	NTN
SLX280X460X200	280,000	460,000	200,000	127,80	26	NTN

Reference	d	D	B	Kg		Brands
SLX280X460X260	280,000	460,000	260,000	166,30	26	NTN
SLX285X460X190	285,000	460,000	190,000	193,00	26	NTN
SLX285X460X260	285,000	460,000	260,000	133,00	26	NTN
SLX28X74X42	28,000	74,000	42,000	0,70	26	NTN
SLX300X480X170	300,000	480,000	170,000	125,00	26	NTN
SLX30X80X51	30,000	80,000	51,000	1,45	26	NTN
SLX30X85X40	30,000	85,000	40,000	1,30	26	NTN
SLX30X85X45	30,000	70,000	45,000	0,90	26	NTN
SLX350X600X190	350,000	600,000	190,000	240,00	26	NTN
SLX350X600X280	350,000	600,000	280,000	270,00	26	NTN
SLX35X100X36	35,000	100,000	36,000	1,80	26	NTN
SLX380X520X190	380,000	520,000	190,000	110,00	26	NTN
SLX380X620X200	380,000	620,000	200,000	268,00	26	NTN
SLX380X620X280	380,000	620,000	280,000	280,00	26	NTN
SLX40X62X22	40,000	62,000	22,000	0,23	26	NTN
SLX40X95X40	40,000	95,000	39,000	1,11	26	NTN
SLX50X130X62	50,000	130,000	60,000	4,63	26	NTN
SLX55X140X81	55,000	140,000	81,000	6,96	26	NTN
SLX60X110X84	60,000	110,000	84,000	3,47	26	NTN
SLX60X130X62	60,000	130,000	62,000	4,58	26	NTN
SLX60X145X53	60,000	145,000	53,000	4,50	26	NTN
SLX60X90X25	60,000	90,000	125,000	2,60	26	NTN
SLX80X105X25	80,000	105,000	100,000	2,37	26	NTN
SLX90X160X67	90,000	160,000	67,000	8,30	26	NTN



Tapered roller bearing



Kegelrollenlager



Rodamientos de rodillos cónicos



Конические роликоподшипники



Roulements à rouleaux coniques



Cuscintetti a rulli conici



Rolamentos de rolos cónicos



Łożyska stożkowe







Classification by references – Classification par références

Klassifizierung nach Referenzen – Classificazione per codice





Clasificación por referencias – Classificação por referências

Классификация по кодам – Klasyfikacja wg numerów katalogowych





Reference	d		B		C		T		Kg	Brands
	d	D	B	C	T	Kg				
4T-02420		68,262		17,462		0,15	29	NTN		
4T-02473	25,400		22,225			0,28	29	NTN		
4T-02473/02420	25,400	68,262	22,225	17,462	22,225	0,43	29	NTN		
4T-02474	28,575		22,225			0,26	29	NTN		
4T-02474/02420	28,575	68,262	22,225	17,462	22,225	0,41	29	NTN		
4T-02475	31,750		22,225			0,23	29	NTN		
4T-02475/02420	31,750	68,262	22,225	17,462	22,225	0,38	29	NTN		
4T-02476	31,750		22,225			0,23	29	NTN		
4T-02476/02420	31,750	68,262	22,225	17,462	22,225	0,38	29	NTN		
4T-02820		73,025		17,462		0,16	29	NTN		
4T-02872	28,575		22,225			0,32	29	NTN		
4T-02872/02820	28,575	73,025	22,225	17,462	22,225	0,48	29	NTN		
4T-02875	31,750		22,225			0,29	29	NTN		
4T-02875/02820	31,750	73,025	22,225	17,462	22,225	0,45	29	NTN		
4T-02877	34,925		22,225			0,26	29	NTN		
4T-02877/02820	34,925	73,025	22,225	17,462	23,812	0,42	29	NTN		
4T-02878	34,925		22,225			0,27	29	NTN		
4T-02878/02820	34,925	73,025	22,225	17,462	22,225	0,43	29	NTN		
4T-03062	15,875		14,681			0,06	29	NTN		
4T-03062/03162	15,875	41,275	14,681	11,112	14,681	0,09	29	NTN		
4T-03162		41,275		11,112		0,04	29	NTN		
4T-CR-0468	21,430	50,005	13,470	17,788	17,788	0,16	29	NTN		
4T-05062	15,875		14,381			0,08	29	NTN		
4T-05062/05185	15,875	47,000	14,381	11,112	14,381	0,13	29	NTN		
4T-05066/05185	16,993	47,000	14,381	11,112	14,381	0,13	29	NTN		
4T-05068	17,462		14,381			0,08	29	NTN		
4T-05075	19,050		14,381			0,08	29	NTN		
4T-05075/05185	19,050	47,000	14,381	11,112	14,381	0,12	29	NTN		
4T-05079	19,987		14,381			0,07	29	NTN		
4T-05079/05185	20,000	47,000	14,381	11,112	14,381	0,12	29	NTN		
4T-05079/05185S	20,000	47,000	14,381	11,112	14,381	0,12	29	NTN		
4T-05175		44,450		11,430		0,03	29	NTN		
4T-05185		47,000		11,112		0,05	29	NTN		
4T-05185S		47,000		11,112		0,05	29	NTN		
4T-CR-0566	25,000	52,000	18,000	15,000	19,250	0,19	29	NTN		
4T-CR-0574	26,010	47,000	13,000	11,500	15,000	0,06	29	NTN		
4T-CR-0594	23,812	50,005	14,260	9,525	14,260	0,11	29	NTN		
4T-CR-0620	28,000	58,000	20,000	16,000	20,000	0,25	29	NTN		
4T-CR-0627	30,000	51,000	15,000	11,000	15,000	0,12	29	NTN		
4T-CR-0643	30,000	52,000	16,000	11,500	16,000	0,13	29	NTN		
4T-CR-0643L	30,000	52,000	16,000	11,500	16,000	0,13	29	NTN		
4T-CR-0659	32,000	65,000	26,000	15,000	27,250	0,31	29	NTN		
4T-CR-0676	28,000	50,292	16,724	10,668	16,724	0,11	29	NTN		
4T-CR-0678	31,750	59,131	16,167	11,811	16,167	0,18	29	NTN		
4T-CR-0687	31,750	54,000	15,000	15,000	15,000	0,13	29	NTN		
4T-CR1-0691	30,000	69,012	46,040			0,86	30	NTN		
4T-CR1-0695LL	30,000	60,037	37,000			0,48	30	NTN		
4T-CR-06A84	29,000	50,292	17,547	10,668	17,547	0,12	29	NTN		
CRTD0701	36,000	120,000	240,000			13,80	38	NTN		
E-E07057/107105CD+A	146,050	268,288	160,338			37,80	30	NTN		
4T-07079	20,000		14,260			0,10	29	NTN		
4T-07079/07196	20,000	50,005	14,260	9,525	14,260	0,14	29	NTN		

Reference						Kg	?	Brands
	d	D	B	C	T			
4T-07087	22,225		14,260			0,10	29	NTN
4T-07087/07196	22,225	50,005	14,260	9,525	14,260	0,13	29	NTN
4T-07087/07204	22,225	51,994	14,260	12,700	15,011	0,16	29	NTN
4T-07087/07210X	22,225	50,800	14,260	12,700	15,011	0,15	29	NTN
4T-07087X	22,225		14,260			0,10	29	NTN
4T-07087X/07210X	22,225	50,800	14,260	12,700	15,011	0,15	29	NTN
4T-07093	23,812		14,260			0,09	29	NTN
4T-07096/07196	25,159	50,005	14,260	9,525	13,495	0,12	29	NTN
4T-07097	25,000		14,260			0,08	29	NTN
4T-07097/07196	25,000	50,005	14,260	9,525	13,495	0,12	29	NTN
4T-07098	24,981		14,260			0,08	29	NTN
4T-07098/07196	24,981	50,005	14,260	9,525	13,495	0,12	29	NTN
4T-07100	25,400		14,260			0,08	29	NTN
4T-07100/07196	25,400	50,005	14,260	9,525	13,495	0,12	29	NTN
4T-07100/07204	25,400	51,994	14,260	12,700	15,011	0,14	29	NTN
4T-07100/07210X	25,400	50,800	14,260	12,700	15,011	0,13	29	NTN
4T-07100S	25,400		14,260			0,08	29	NTN
4T-07100S/07196	25,400	50,005	14,260	9,525	14,260	0,12	29	NTN
4T-07100S/07204	25,400	51,994	14,260	12,700	15,011	0,14	29	NTN
4T-07100S/07210X	25,400	50,800	14,260	12,700	15,011	0,13	29	NTN
4T-07100SA	25,400		14,260			0,08	29	NTN
4T-07100SA/07210X	25,400	50,800	14,260	12,700	15,011	0,13	29	NTN
4T-07196		50,005		9,525		0,03	29	NTN
4T-07204		51,994		12,700		0,06	29	NTN
4T-07205		52,000		12,700		0,06	29	NTN
4T-07210X		50,800		12,700		0,05	29	NTN
E-CRT0752V	35,000	65,000	18,000			0,28	37	NTN
E-CR1-07A01LL	35,000	140,000	76,700			3,92	30	NTN
4T-CR-07A14	35,000	70,000	23,000	18,500	24,250	0,42	29	NTN
4T-08125/08231	31,750	58,738	15,080	10,716	14,684	0,16	29	NTN
CR-0864	40,000	80,000	29,000	23,000	30,000	0,66	29	NTN
E-CR1-0874	40,000	86,000	47,000			1,20	30	NTN
E-CR1-0875	40,000	111,000	48,000			2,26	30	NTN
4T-CR-0880	41,000	78,000	18,000	13,500	18,000	0,36	29	NTN
4T-CR-0889	38,100	65,088	21,139	13,970	21,139	0,24	29	NTN
4T-CR-0891	40,000	68,000	19,000	17,500	22,000	0,29	29	NTN
4T-CR-0898	40,000	76,200	17,384	14,288	18,009	0,33	29	NTN
4T-CR-08A37	40,000	85,000	19,000	16,000	20,750	0,56	29	NTN
4T-CR-08A75	38,000	80,000	22,000	16,000	24,000	0,53	29	NTN
4T-CR-08A86	39,688	80,167	32,941	23,812	29,370	0,67	29	NTN
4T-CR-08B01	40,000	90,000			23,250	0,70	29	NTN
4T-09062	15,875		21,539			0,14	29	NTN
4T-09062/09195	15,875	49,225	21,539	14,288	21,539	0,20	29	NTN
4T-09067	19,050		19,050			0,11	29	NTN
4T-09067/09195	19,050	49,225	19,050	14,288	19,845	0,17	29	NTN
4T-09067/09196	19,050	49,225	19,050	17,462	23,020	0,20	29	NTN
4T-09074	19,050		21,539			0,12	29	NTN
4T-09074/09194	19,050	49,225	19,050	17,462	23,020	0,20	29	NTN
4T-09074/09195	19,050	49,225	19,050	14,288	19,845	0,19	29	NTN
4T-09074/09196	19,050	49,225	19,050	17,462	23,020	0,21	29	NTN
4T-09078	19,063		21,539			0,12	29	NTN
4T-09078/09195	19,050	49,225	21,539	14,288	19,845	0,19	29	NTN





Reference	d		D		B	C	T	Kg	Brands
	d	D	B	C	T				
4T-09081	20,625		21,539				0,11	29	NTN
4T-09081/09195	20,625	49,225	21,539	14,288	21,539		0,18	29	NTN
4T-09081/09196	20,625	49,225	21,539	17,462	23,020		0,19	29	NTN
4T-09194		49,225		17,462			0,08	29	NTN
4T-09195		49,225		14,288			0,07	29	NTN
4T-09196		49,225		17,462			0,08	29	NTN
E-CRT0953V	45,000	76,000	22,000				0,42	37	NTN
CR-0996	45,000	90,000	29,000	20,000	29,000		0,82	29	NTN
4T-CR-09A47	44,450	88,900	29,370	23,020	30,162		0,86	29	NTN
4T-CR-09B11	45,000	75,000	20,000	17,700	22,200		0,36	29	NTN
CRO-10003	500,000	730,000	440,000				535,00	32	NTN
E-CRO-10003	500,000	730,000	440,000				535,00	32	NTN
CRI-10004	500,000	670,000	180,000				175,00	30	NTN
CRD-10005	500,000	670,000	150,000				148,00	31	NTN
CRO-10005	500,000	690,000	480,000				600,00	32	NTN
E-CRO-10005	500,000	690,000	480,000				600,00	32	NTN
CRD-10008	500,000	820,000	256,000				535,00	31	NTN
CRO-10008	500,000	670,000	515,000				598,00	32	NTN
E-CRO-10008	500,000	670,000	515,000				598,00	32	NTN
CR-10010DB	500,000	640,000	500,000				346,00	30	NTN
E-CRT1002	550,000	760,000	230,000				296,00	37	NTN
CRO-10023	500,000	730,000	420,000				606,00	32	NTN
CR-10024	500,000	750,000	140,000	120,000	150,000		224,00	29	NTN
CRD-10206	510,134	800,001	284,493				511,00	31	NTN
CRD-10208	509,948	733,425	200,020				256,00	31	NTN
CRO-10208 (CRO-10214)	509,948	654,924	377,000				320,00	32	NTN
E-CRD-10211	509,948	733,425	200,020				273,00	31	NTN
4T-LM102910		73,431		15,748			0,10	29	NTN
4T-LM102911		73,431		17,620			0,12	29	NTN
4T-LM102949	45,242		19,812				0,20	29	NTN
4T-LM102949/LM102910	45,242	73,431	19,812	15,748	19,812		0,31	29	NTN
CRO-10402	520,000	735,000	535,000				750,00	32	NTN
E-CRO-10402	520,000	735,000	535,000				750,00	32	NTN
4T-JLM104910		82,000		17,000			0,13	29	NTN
4T-LM104911		82,550		16,510			0,13	29	NTN
4T-LM104911A		82,550		18,542			0,16	29	NTN
4T-LM104912		82,931		16,510			0,14	29	NTN
4T-LM104947A/LM104911	49,987	82,550	22,225	16,510	21,590		0,43	29	NTN
4T-JLM104948	50,000		21,500				0,29	29	NTN
4T-JLM104948/JLM104910	50,000	82,000	21,500	17,000	21,500		0,42	29	NTN
4T-LM104949	50,800		22,225				0,28	29	NTN
4T-LM104949/LM104911	50,800	82,550	22,225	16,510	21,590		0,42	29	NTN
4T-LM104949/LM104912	50,800	82,931	22,225	16,510	22,225		0,42	29	NTN
CRD-1052	50,000	180,000	135,000				17,80	31	NTN
E-CRT1053V	50,000	82,000	22,000				0,47	37	NTN
CR-10601	530,000	670,000	95,000	82,000	100,000		76,20	29	NTN
CR-10604DB	530,000	670,000	270,000				198,00	30	NTN
CRO-10607LL	530,000	715,000	590,000				700,00	32	NTN
CRI-10702	533,400	736,600	225,425				268,00	30	NTN
CRO-10702	533,400	965,200	495,300				1 662,00	32	NTN
4T-CR-1075	52,388	85,000	20,000	15,000	20,000		0,41	29	NTN
4T-CR-1084	50,000	93,264	30,302	23,812	30,302		0,86	29	NTN

Reference						Kg	?	Brands
	d	D	B	C	T			
4T-CR-1091	50,800	104,775	30,958	23,812	30,958	1,30	29	NTN
4T-CR-10A28	47,625	100,000	29,370	23,020	30,162	1,11	29	NTN
4T-CR-10A33	50,000	110,000	27,000	19,000	29,250	1,21	29	NTN
4T-CR-10A62	50,000	90,000	28,000	23,000	28,000	0,74	29	NTN
CRD-11001	550,000	920,000	330,000			914,00	31	NTN
CR0-11101 (CRO-11103)	555,625	698,500	349,250			298,00	32	NTN
4T-M111012		107,950		20,320		0,31	29	NTN
4T-M111048	63,500		25,908			0,59	29	NTN
4T-11162	41,275		17,384			0,21	29	NTN
4T-11162/11300	41,275	76,200	17,384	14,288	18,009	0,34	29	NTN
4T-11162/11315	41,275	80,000	17,384	14,288	18,009	0,39	29	NTN
CR1-11206	560,000	735,000	225,000			224,00	30	NTN
CR1-11206	560,000	735,000	225,000			232,00	30	NTN
CRD-11207	560,000	820,000	195,000			347,00	31	NTN
CR1-11211	560,000	740,000	190,000			198,00	30	NTN
CR1-11213	560,000	820,000	244,000			415,00	30	NTN
CR1-11214	560,000	820,000	195,000			340,00	30	NTN
E-CR-11220	560,000	736,000	104,775	80,962	104,775	104,78	29	NTN
E-CR-11221	558,952	736,600	104,775	80,962	104,775	114,00	29	NTN
4T-11300		76,200		14,288		0,13	29	NTN
EE113089/113170	228,397	431,800	85,725	49,212	92,075	59,40	29	NTN
EE113091/113170	228,460	431,800	85,725	49,212	92,075	59,40	29	NTN
EE113091/113171D+A	228,460	431,800	196,850			116,00	30	NTN
CR1-11401	570,000	815,000	345,000			512,00	30	NTN
CR-11402	570,000	695,000	52,000	50,000	57,000	41,70	29	NTN
CR0-11402	570,000	780,000	515,000			625,00	32	NTN
E-CR0-11402	570,000	780,000	515,000			625,00	32	NTN
CR0-11403	570,000	810,000	590,000			845,00	32	NTN
E-CR0-11403	570,000	810,000	590,000			845,00	32	NTN
EE114080/114160	203,200	406,400	85,725	57,150	92,075	54,80	29	NTN
EE114080/114161D+A	203,200	406,400	196,850			107,00	30	NTN
4T-11520		42,862		9,525		0,04	29	NTN
CR-1154	55,000	100,000	31,000	24,500	32,000	1,04	29	NTN
4T-11590	15,875		14,288			0,06	29	NTN
4T-11590/11520	15,875	42,863	14,288	9,525	14,288	0,10	29	NTN
4T-L116149/L116110	82,550	115,888	21,433	16,670	20,638	0,64	29	NTN
CR1-1163	53,987	140,025	69,850			5,13	30	NTN
CRD-11701	585,788	771,525	230,188			285,00	31	NTN
CR0-11701	585,788	771,525	479,425			610,00	32	NTN
EE117063/117148	161,925	374,650	79,375	60,325	87,312	47,90	29	NTN
4T-LM11710		39,878		10,668		0,03	29	NTN
4T-LM11749	17,462		14,605			0,06	29	NTN
4T-LM11749/LM11710	17,462	39,878	14,605	10,668	14,605	0,08	29	NTN
4T-CR-1175	55,000	100,000	42,250	35,000	42,250	1,35	29	NTN
CR1-11801	590,000	780,000	255,000			291,00	30	NTN
4T-CR1-1185	55,000	90,000	52,000			1,20	30	NTN
4T-LM11910		45,237		12,065		0,04	29	NTN
CR0-11913	595,312	844,550	615,950			1 135,00	32	NTN
CR0-11919LL	595,312	844,550	615,950			1 130,00	32	NTN
4T-CR-1193DF	53,975	95,199	19,050	13,492	38,100	1,13	29	NTN
4T-CR-1194	57,150	100,000	21,946	16,238	21,946	0,64	29	NTN
4T-LM11949	19,050		16,637			0,08	29	NTN





Reference	d		D		B	C	T	Kg	Brands
	d	D	B	C	T				
4T-LM11949/LM11910	19,050	45,237	16,637	12,065	16,637	0,12	29	NTN	
4T-LM11949L	19,050		16,637			0,08	29	NTN	
4T-LM11949L/LM11910	19,050	45,237	16,637	12,065	17,066	0,13	29	NTN	
CRD-12002	600,000	1 000,000	350,000			1 130,00	31	NTN	
CRD-12005	600,000	760,000	115,000			120,00	31	NTN	
CR-12006	600,000	870,000	111,000	93,000	118,000	208,70	29	NTN	
CRD-12006	600,000	870,000	380,000			758,00	31	NTN	
E-CRD-12011	600,000	820,000	160,000			253,00	31	NTN	
E-CRT1215V	60,000	495,300	170,612			181,00	37	NTN	
4T-12175	44,450		17,145			0,21	29	NTN	
4T-12175/12303	44,450	76,992	17,145	11,908	17,462	0,31	29	NTN	
4T-1220		57,150		17,462		0,11	29	NTN	
CRO-12202	611,500	832,800	593,725			960,00	32	NTN	
4T-12303		76,992		11,908		0,10	29	NTN	
CR1-1252	60,000	175,000	69,000			7,58	30	NTN	
4T-12520		49,225		15,875		0,07	29	NTN	
CR-1252L	60,000	95,000	26,000	21,000	27,000	0,65	29	NTN	
CR-1257	60,325	140,000	36,513	33,000	38,500	2,70	29	NTN	
4T-12580	20,638		19,845			0,11	29	NTN	
4T-12580/12520	20,638	49,225	19,845	15,875	19,845	0,18	29	NTN	
E-HM125948/HM125910	123,825	204,775	60,325	45,237	55,562	7,13	29	NTN	
CRO-12604	630,000	920,000	600,000			1 390,00	32	NTN	
EE126096D/126150/126151D	244,475	381,000	304,800			132,00	32	NTN	
E-EE126096D/126150/126151D	244,475	381,000	304,800			132,00	32	NTN	
EE126096D/126150+A	244,475	381,000	146,050			61,40	31	NTN	
EE126097/126150	244,475	381,000	76,200	57,150	79,375	32,60	29	NTN	
EE126097/126151D+A	244,475	381,000	171,450			64,00	30	NTN	
EE126098/126150	249,250	381,000	76,200	57,150	79,375	31,70	29	NTN	
EE126098/126151D+A	249,250	381,000	171,450			62,20	30	NTN	
4T-M12610		50,005		13,970		0,06	29	NTN	
4T-M12648	22,225		18,288			0,11	29	NTN	
4T-M12648/M12610	22,225	50,005	18,288	13,970	17,526	0,17	29	NTN	
4T-M12648A	22,225		18,288			0,11	29	NTN	
4T-M12649	21,430		18,288			0,11	29	NTN	
4T-M12649/M12610	21,430	50,005	18,288	13,970	18,288	0,17	29	NTN	
4T-CR1-1264ZZ	60,000	125,000	70,000			3,53	30	NTN	
4T-CR1-1265	60,000	140,000	67,000			4,23	30	NTN	
CR-12701	635,000	850,000	105,000	75,000	105,000	151,00	29	NTN	
CR-12702	635,000	812,800	95,250	73,025	95,250	118,60	29	NTN	
EE127095/127135	241,300	349,148	57,150	44,450	57,150	15,90	29	NTN	
EE127095/127136D+A	241,300	349,148	127,000			35,40	30	NTN	
EE127097D/127135+A	241,478	349,148	107,950			33,80	31	NTN	
EE127097D/127137/127137D	241,478	350,838	228,600			76,40	32	NTN	
E-EE127097D/127137/127137D	241,478	350,838	228,600			76,40	32	NTN	
4T-LM12710		45,237		12,065		0,04	29	NTN	
4T-LM12711		45,974		12,065		0,04	29	NTN	
4T-CR-1272	60,325	101,600	28,400	19,845	28,400	0,87	29	NTN	
4T-LM12748	21,430		16,637			0,08	29	NTN	
4T-LM12748/LM12710	21,430	45,237	16,637	12,065	16,637	0,12	29	NTN	
4T-LM12749	21,986		16,637			0,08	29	NTN	
4T-LM12749/LM12710	21,986	45,237	16,637	12,065	16,637	0,12	29	NTN	
4T-LM12749/LM12711	21,986	45,974	16,637	12,065	16,637	0,12	29	NTN	

Reference						Kg	?	Brands
	d	D	B	C	T			
4T-1280	22,225		22,225			0,18	29	NTN
4T-1280/1220	22,225	57,150	22,225	17,462	22,225	0,29	29	NTN
4T-CR-1281	61,000	150,000	35,000	30,000	38,000	3,38	29	NTN
EE128111/128160	280,192	406,400	67,673	53,975	69,850	29,10	29	NTN
EE128111/128160D+A	280,192	406,400	149,225			56,50	30	NTN
EE128112/128160	280,000	406,400	67,673	53,975	69,850	29,10	29	NTN
T-EE129120X/129120D+A	304,800	438,048	165,100			71,40	30	NTN
T-EE129120X/129172	304,800	438,048	76,992	53,975	76,200	34,80	29	NTN
CRO-13001	650,000	1 030,000	560,000			1 760,00	32	NTN
4T-C1R-1301	65,000	111,500	58,000			2,91	30	NTN
T-EE130902/131400	228,600	355,600	69,850	49,212	69,850	22,70	29	NTN
T-EE130902/131401D+A	228,600	355,600	152,400			49,40	30	NTN
CRO-13202	660,000	1 070,000	642,000			1 950,00	32	NTN
E-CRO-13202	660,000	1 070,000	642,000			1 950,00	32	NTN
CRD-13208	660,000	814,000	176,212			202,00	31	NTN
EE132082D/132125/132126D	203,200	317,500	215,900			62,50	32	NTN
E-EE132082D/132125/132126D	203,200	317,500	215,900			62,50	32	NTN
E-NA132083/132126D	203,200	317,500	120,650			31,00	30	NTN
CRD-13209	660,400	762,000	98,425			71,10	31	NTN
4T-1328		52,388		14,288		0,07	29	NTN
4T-1329		53,975		14,288		0,08	29	NTN
CRI-13401	670,000	880,000	185,000			277,00	30	NTN
CRO-13401	670,000	960,000	700,000			1 600,00	32	NTN
CRI-13402	670,000	830,000	180,000			201,00	30	NTN
CRO-13402	670,000	1 090,000	710,000			2 600,00	32	NTN
CRO-13404	670,000	1 090,000	710,000			2 690,00	32	NTN
T-EE134100/134143	254,000	365,125	58,738	42,862	58,738	17,70	29	NTN
T-EE134100/134144D+A	254,000	365,125	130,175			39,20	30	NTN
T-EE134102/134143	260,350	365,125	58,738	42,862	58,738	16,80	29	NTN
T-EE134102/134144D+A	260,350	365,125	130,175			37,30	30	NTN
EE134102D/134143/134144D	260,350	365,125	228,600			76,50	32	NTN
E-EE134102D/134143/134144D	260,350	365,125	228,600			76,50	32	NTN
EE135111D/135155/135156D	279,400	393,700	269,875			103,00	32	NTN
EE135111D/135155+A	279,400	393,700	127,000			48,10	31	NTN
CRO-13602	680,000	870,000	460,000			582,00	32	NTN
E-CRO-13602	680,000	870,000	460,000			582,00	32	NTN
4T-13620		69,012		15,083		0,10	29	NTN
4T-13621		69,012		15,083		0,10	29	NTN
CR-1363	65,000	100,000	23,000	19,000	23,000	0,62	29	NTN
4T-13685	38,100		19,050			0,19	29	NTN
4T-13685/13620	38,100	69,012	19,050	15,083	19,050	0,29	29	NTN
4T-13685/13621	38,100	69,012	19,050	15,083	19,050	0,29	29	NTN
4T-13685L	38,100		19,050			0,19	29	NTN
4T-13686	38,113		26,195			0,25	29	NTN
4T-13687	38,100		19,050			0,19	29	NTN
4T-13687/13620	38,100	69,012	19,050	15,083	19,050	0,30	29	NTN
4T-13687/13621	38,100	69,012	19,050	15,083	19,050	0,30	29	NTN
CRD-13701	685,876	939,876	234,950			435,00	31	NTN
CRD-13702	685,800	939,800	234,950			478,00	31	NTN
CR1-1372LL	65,000	140,000	77,500			2,73	30	NTN
4T-1380	22,225		20,168			0,13	29	NTN
4T-1380/1328	22,225	52,388	20,168	14,288	23,178	0,20	29	NTN





Reference	d		D		B	C	T	Kg	Brands	
4T-13830			63,500			9,525		0,05	29	NTN
4T-13836			65,088			9,525		0,06	29	NTN
4T-13889	38,100			11,908				0,10	29	NTN
4T-13889/13830	38,100		63,500	11,908		9,525	12,700	0,15	29	NTN
4T-CR-13A21	65,000		90,000	17,000		15,000	18,000	0,33	29	NTN
CR-14003	700,000		850,000	93,000		74,000	96,000	106,00	29	NTN
CRD-14003	700,000		890,000	150,000				224,00	31	NTN
4T-14116	30,226			19,583				0,24	29	NTN
4T-14116/14274	30,226		69,012	19,583		15,875	19,845	0,37	29	NTN
4T-14116/14276	30,226		69,012	19,583		15,875	19,845	0,37	29	NTN
4T-14117A	30,000			19,583				0,23	29	NTN
4T-14117A/14276	30,000		69,012	19,583		15,875	19,845	0,37	29	NTN
4T-14118	30,000			19,202				0,23	29	NTN
4T-14118/14283	30,000		72,085	19,202		18,415	22,385	0,44	29	NTN
4T-14118S	30,009			19,583				0,24	29	NTN
4T-14123A	31,750			26,721				0,26	29	NTN
4T-14124	31,750			19,583				0,22	29	NTN
4T-14124/14276	31,750		69,012	19,583		15,875	19,845	0,36	29	NTN
4T-14125A	31,750			19,583				0,22	29	NTN
4T-14125A/14274	31,750		69,012	19,583		15,875	19,845	0,35	29	NTN
4T-14125A/14276	31,750		69,012	19,583		15,875	19,845	0,36	29	NTN
4T-14130	33,338			19,583				0,21	29	NTN
4T-14130/14274	33,338		69,012	19,583		15,875	19,845	0,34	29	NTN
4T-14130/14276	33,338		69,012	19,583		15,875	19,845	0,34	29	NTN
4T-14131	33,338			19,583				0,21	29	NTN
4T-14131/14274	33,338		69,012	19,583		15,875	19,845	0,34	29	NTN
4T-14131/14276	33,338		69,012	19,583		15,875	19,845	0,35	29	NTN
4T-14136A	34,925			26,721				0,23	29	NTN
4T-14136AA	34,925			26,721				0,23	29	NTN
4T-14137A	34,925			19,583				0,20	29	NTN
4T-14137A/14274	34,925		69,012	19,583		15,875	19,845	0,33	29	NTN
4T-14137A/14276	34,925		69,012	15,583		15,875	19,845	0,33	29	NTN
4T-14138A	34,925			19,583				0,20	29	NTN
4T-14138A/14274	34,925		69,012	19,583		15,875	19,845	0,32	29	NTN
4T-14138A/14276	34,925		69,012	19,583		15,875	19,845	0,33	29	NTN
4T-14139	34,976			19,583				0,20	29	NTN
4T-14139/14276	34,976		69,012	19,583		15,875	19,845	0,33	29	NTN
CRI-14207	710,000		1 030,000	236,000				654,00	30	NTN
CRD-14208	710,000		900,000	410,000				620,00	32	NTN
E-CRD-14208	710,000		900,000	410,000				620,00	32	NTN
CRI-14209	710,000		1 030,000	295,000				810,00	30	NTN
CRD-14209LL	711,200		914,400	410,000				596,00	32	NTN
CRD-14214LL	711,200		914,400	387,350				616,00	32	NTN
4T-14274			69,012			15,875		0,13	29	NTN
4T-14276			69,012			15,875		0,13	29	NTN
4T-14282			71,996			15,032		0,16	29	NTN
4T-14283			72,085			18,415		0,21	29	NTN
CR1-14402	720,000		880,000	210,000				244,00	30	NTN
E-CRD-14402LL	720,000		1 060,000	545,000				1 400,00	31	NTN
CR-14403	720,000		880,000	75,000		60,000	80,000	94,00	29	NTN
CRD-14403	720,000		920,000	130,000				240,00	31	NTN
HH144642/HH144614	200,025		393,700	111,125		84,138	111,125	55,90	29	NTN

Reference						Kg	?	Brands
	d	D	B	C	T			
CR1-1460	70,000	249,000	100,000			24,40	30	NTN
CR0-14601	730,000	1 070,000	642,000			1 900,00	32	NTN
E-CR0-14601	730,000	1 070,000	642,000			1 900,00	32	NTN
CR1-1461	70,000	204,000	76,200			16,00	30	NTN
EE147112/147198D+A	285,750	501,650	203,200			151,00	30	NTN
CR-14803	740,000	900,000	75,000	65,000	80,000	96,00	29	NTN
CR-14901	745,000	1 000,000	115,000	83,000	115,000	237,00	29	NTN
E-CR1-1493LL	70,000	240,000	90,000			13,19	30	NTN
CRD-15001	750,000	1 075,000	320,000			955,00	31	NTN
CRT15001	749,300	958,000	127,000			245,00	37	NTN
CR-15002	750,000	1 000,000	107,000	80,000	110,000	210,00	29	NTN
4T-15100	25,400		20,638			0,22	29	NTN
4T-15100/15245	25,400	62,000	20,638	14,288	20,638	0,30	29	NTN
4T-15100/15250X	25,400	63,500	20,638	15,875	20,638	0,33	29	NTN
4T-15100S	25,400		20,638			0,21	29	NTN
4T-15100S/15245	25,400	62,000	20,638	14,288	20,638	0,29	29	NTN
4T-15100S/15250X	25,400	63,500	20,638	15,875	20,638	0,33	29	NTN
4T-15101	25,400		20,638			0,23	29	NTN
4T-15101/15243	25,400	61,912	20,638	14,288	19,050	0,30	29	NTN
4T-15101/15245	25,400	62,000	20,638	14,288	20,638	0,30	29	NTN
4T-15101/15250X	25,400	63,500	20,638	15,875	20,638	0,34	29	NTN
4T-15102	25,400		20,638			0,22	29	NTN
4T-15103/15245	26,157	62,000	20,638	14,288	19,050	0,30	29	NTN
4T-15103S	26,162		19,939			0,21	29	NTN
4T-15103S/15243	26,162	61,912	19,939	14,288	19,939	0,29	29	NTN
4T-15106	26,988		20,638			0,21	29	NTN
4T-15106/15245	26,988	62,000	20,638	14,288	20,638	0,29	29	NTN
4T-15106/15250	26,988	62,000	20,638	15,875	20,638	0,32	29	NTN
4T-15106/15250X	26,988	63,500	20,638	15,875	20,638	0,32	29	NTN
4T-15112	28,575		20,638			0,20	29	NTN
4T-15112/15245	28,575	62,000	20,638	14,288	20,638	0,28	29	NTN
4T-15112/15250	28,575	63,500	20,638	15,875	20,638	0,31	29	NTN
4T-15113	28,575		20,638			0,20	29	NTN
4T-15113/15245	28,575	62,000	20,638	14,288	20,638	0,28	29	NTN
4T-15116	30,112		20,638			0,19	29	NTN
4T-15116/15245	30,112	62,000	20,638	14,288	19,050	0,27	29	NTN
4T-15117	30,000		20,638			0,19	29	NTN
4T-15117/15244	30,000	62,000	20,638	15,875	20,638	0,28	29	NTN
4T-15117/15245	29,987	62,000	20,638	14,288	20,638	0,27	29	NTN
NA15117SW/K33867	30,005	88,900	50,803			1,56	30	NTN
4T-15118	30,213		20,638			0,18	29	NTN
4T-15118/15245	30,213	62,000	20,638	14,288	20,638	0,26	29	NTN
4T-15118/15250	30,213	63,500	20,638	15,875	20,638	0,30	29	NTN
4T-15118/15250X	30,213	63,500	20,638	15,875	20,638	0,30	29	NTN
4T-15119	30,213		20,638			0,19	29	NTN
4T-15119/15245	30,213	62,000	20,638	14,288	19,050	0,27	29	NTN
CRT1512	76,200	161,925	33,338			3,58	37	NTN
4T-15120	30,213		20,638			0,19	29	NTN
4T-15120/15245	30,213	62,000	20,638	14,288	19,050	0,27	29	NTN
4T-15123	31,750		19,050			0,16	29	NTN
4T-15123/15245	31,750	62,000	19,050	14,288	19,050	0,24	29	NTN
4T-15125	31,750		20,638			0,17	29	NTN





Reference	d		D		B	C	T	Kg	?	Brands
	d	D	B	C	T					
4T-15125/15245	31,750	62,000	20,638	14,288	20,638	0,25	29	NTN		
4T-15126	31,750		20,638			0,17	29	NTN		
4T-15126/15245	31,750	62,000	20,638	14,288	19,050	0,26	29	NTN		
4T-15243		61,912		14,288		0,08	29	NTN		
4T-15244		62,000		15,875		0,08	29	NTN		
4T-15245		62,000		14,288		0,08	29	NTN		
4T-15250		63,500		15,875		0,11	29	NTN		
4T-15250X		63,500		15,875		0,11	29	NTN		
4T-15520		57,150		13,495		0,07	29	NTN		
4T-15523		60,325		15,875		0,16	29	NTN		
4T-15578	25,413		17,462			0,15	29	NTN		
4T-15578/15520	25,400	57,150	17,462	13,495	17,462	0,21	29	NTN		
4T-15578/15523	25,400	60,325	17,462	15,875	19,842	0,27	29	NTN		
4T-15579X	26,000		17,462			0,14	29	NTN		
4T-15579X/15520	26,000	57,150	17,462	13,495	17,462	0,21	29	NTN		
4T-15580	26,988		17,462			0,14	29	NTN		
4T-15580/15520	26,988	57,150	17,462	13,495	17,462	0,21	29	NTN		
4T-15590	28,575		17,462			0,13	29	NTN		
4T-15590/15520	28,575	57,150	17,462	13,495	17,462	0,19	29	NTN		
4T-15590/15523	28,575	60,325	17,462	15,875	19,842	0,25	29	NTN		
CRD-15601	780,000	1 000,000	200,000			384,00	31	NTN		
CR-15602	780,000	925,000	92,000	75,000	95,000	115,00	29	NTN		
E-CR-15602	780,000	925,000	92,000	75,000	95,000	103,00	29	NTN		
CR1-1561	75,000	130,000	80,000			4,00	30	NTN		
CRI-16001	800,000	1 150,000	350,000			1 119,00	30	NTN		
CRO-16001	800,000	1 120,000	820,000			3 960,00	32	NTN		
E-CRO-16001	800,000	1 120,000	820,000			3 960,00	32	NTN		
T-EE161300/161900	330,200	482,600	55,562	38,100	60,325	35,90	29	NTN		
T-EE161300/161901D+A	330,200	482,600	133,350			72,20	30	NTN		
T-EE161363/161900	346,075	482,600	55,562	38,100	60,325	32,80	29	NTN		
T-EE161363/161901D+A	346,075	482,600	133,350			66,00	30	NTN		
4T-16137/16284	34,925	72,238	20,638	15,875	20,638	0,39	29	NTN		
T-EE161400/161850	355,600	469,900	55,562	38,100	60,325	27,30	29	NTN		
T-EE161400/161900	355,600	482,600	55,562	38,100	60,325	30,80	29	NTN		
T-EE161400/161901D+A	355,600	482,600	133,350			62,10	30	NTN		
4T-16150	38,100		20,638			0,21	29	NTN		
4T-16150/16282	38,100	72,000	20,638	14,237	19,000	0,33	29	NTN		
4T-16150/16283	38,100	72,238	20,638	19,050	23,812	0,39	29	NTN		
4T-16150/16284	38,100	72,238	20,638	15,875	20,638	0,35	29	NTN		
4T-16282		72,000		14,237		0,12	29	NTN		
4T-16283		72,238		19,050		0,18	29	NTN		
4T-16284		72,238		15,875		0,14	29	NTN		
CR1-16301	812,800	1 066,800	190,500			410,00	30	NTN		
T-L163149/L163110	355,600	444,500	60,325	47,625	60,325	18,80	29	NTN		
T-L163149/L163110D+A	355,600	444,500	136,525			42,50	30	NTN		
E-L163149D/L163110/L163110D	355,600	444,500	241,300			89,50	32	NTN		
L163149D/L163110/L163110D	355,600	444,500	241,300			89,50	32	NTN		
T-L163149D/L163110+A	355,600	444,500	114,300			40,10	31	NTN		
CR1-1677C3	80,000	140,000	61,000			3,54	30	NTN		
CRO-16803	840,000	1 170,000	840,000			3 970,00	32	NTN		
E-CRO-16803	840,000	1 170,000	840,000			3 970,00	32	NTN		
CR-17001	850,000	1 120,000	112,000	80,000	118,000	276,00	29	NTN		

Reference						Kg	?	Brands
	d	D	B	C	T			
CRD-17003	850,000	1 250,000	370,000			1 562,00	31	NTN
EE170950/171450	241,300	368,300	50,800	33,338	50,800	17,20	29	NTN
EE170950/171450D+A	241,300	368,300	120,650			40,80	30	NTN
EE170975/171450	247,650	368,300	50,800	50,800	50,800	16,50	29	NTN
EE170975/171451D+A	247,650	368,300	120,650			39,20	30	NTN
EE170975D/171450+A	254,000	368,300	92,862			32,50	31	NTN
4T-17098/17244	24,981	62,000	16,566	14,288	16,002	0,26	29	NTN
EE171000D/171450/171451D	254,000	368,300	204,622			71,80	32	NTN
E-EE171000D/171450/171451D	254,000	368,300	204,622			71,80	32	NTN
4T-17118	29,987		16,566			0,14	29	NTN
4T-17118/17244	29,987	62,000	16,566	14,288	16,566	0,23	29	NTN
4T-17119/17244	30,162	62,000	16,566	14,288	16,566	0,23	29	NTN
4T-17244		62,000		14,288		0,09	29	NTN
4T-1729		56,896		15,875		0,10	29	NTN
4T-1729X		56,896		15,875		0,10	29	NTN
4T-1730		53,975		15,875		0,07	29	NTN
4T-17520		42,862		13,495		0,05	29	NTN
4T-1755	22,225		19,837			0,16	29	NTN
4T-1755/1729	22,225	56,896	19,837	15,875	19,368	0,26	29	NTN
4T-17580	15,875		16,670			0,07	29	NTN
4T-17580/17520	15,875	42,862	16,670	13,495	16,670	0,12	29	NTN
4T-1775	19,050		19,837			0,17	29	NTN
4T-1775/1729	19,050	56,896	19,837	15,875	19,368	0,27	29	NTN
4T-1779	23,812		19,837			0,15	29	NTN
4T-1779/1729	23,812	56,896	19,837	15,875	19,368	0,25	29	NTN
4T-1780	25,400		19,837			0,14	29	NTN
4T-1780/1729	25,400	56,896	19,837	15,875	19,368	0,24	29	NTN
4T-17830		79,375		15,875		0,13	29	NTN
4T-17831		79,985		15,080		0,13	29	NTN
4T-17831SA		79,985		15,080		0,13	29	NTN
4T-17887	45,230		20,638			0,27	29	NTN
4T-17887/17831	45,230	79,985	20,638	15,080	20,638	0,40	29	NTN
4T-17887/17831SA	45,230	79,985	20,638	15,080	19,842	0,40	29	NTN
4T-17887SA	45,230		20,638			0,27	29	NTN
4T-17888	44,450		31,354			0,40	29	NTN
CR-18011DB	900,000	1 120,000	430,000			785,00	30	NTN
CR1-1812ZZC3	90,000	300,000	119,000			40,70	30	NTN
EE181455D/182350/182351D	368,300	596,900	342,900			373,00	32	NTN
CRT18401	920,000	1 120,000	150,000			269,00	37	NTN
4T-18520		73,025		12,700		0,08	29	NTN
4T-18590	41,275		17,462			0,20	29	NTN
4T-18590/18520	41,275	73,025	17,462	12,700	17,462	0,28	29	NTN
E-CR-18604	930,000	1 060,000	90,000	76,000	92,000	114,00	29	NTN
E-CR-18605	928,000	1 060,000	90,000	76,000	92,000	116,00	29	NTN
4T-18620		79,375		13,495		0,12	29	NTN
4T-18685	44,450		17,462			0,22	29	NTN
4T-18685/18620	44,450	79,375	17,462	13,495	17,462	0,35	29	NTN
4T-18690	46,038		17,462			0,21	29	NTN
4T-18690/18620	46,038	79,375	17,462	13,495	17,462	0,33	29	NTN
CR1-1871	90,000	140,000	72,500			3,67	30	NTN
4T-18720		85,000		13,495		0,13	29	NTN
4T-18780	46,038		17,462			0,29	29	NTN





Reference	d		D		B	C	T	Kg	?	Brands
	d	D	B	C	T					
4T-18790	50,800		17,462				0,24	29	NTN	
4T-18790/18720	50,800	85,000	17,462	13,495	17,462		0,37	29	NTN	
4T-18790/18724	50,800	88,900	17,462	13,495	17,462		0,43	29	NTN	
4T-CR1-1881	90,000	155,000	85,000				6,10	30	NTN	
CRO-19001	950,000	1 360,000	880,000				4 100,00	32	NTN	
E-CRO-19001	950,000	1 360,000	880,000				4 100,00	32	NTN	
4T-19150	38,100		16,520				0,17	29	NTN	
4T-19150/19268	38,100	68,262	16,520	11,908	16,520		0,24	29	NTN	
4T-19150/19281	38,100	71,438	16,520	11,908	15,875		0,27	29	NTN	
4T-19150/19283X	38,100	72,000	16,520	14,288	17,018		0,30	29	NTN	
EE192150/192200	381,000	508,000	58,738	38,100	63,500		34,40	29	NTN	
EE192150/192201D+A	381,000	508,000	139,700				69,00	30	NTN	
4T-1922		57,150		15,875			0,08	29	NTN	
4T-19268		68,262		11,908			0,07	29	NTN	
4T-19283X		72,000		14,288			0,13	29	NTN	
4T-1930		56,896		15,875			0,07	29	NTN	
4T-1931		60,325		15,875			0,11	29	NTN	
4T-1932		58,738		15,080			0,09	29	NTN	
CR1-1959LL	95,000	180,000	100,000				12,00	30	NTN	
4T-1975	22,225		19,355				0,18	29	NTN	
4T-1975/1931	22,225	60,325	19,355	15,875	19,845		0,29	29	NTN	
4T-1985	28,575		19,355				0,14	29	NTN	
4T-1985/1922	28,575	57,150	19,355	15,875	19,845		0,22	29	NTN	
4T-1985/1930	28,575	56,896	19,355	15,875	19,845		0,22	29	NTN	
4T-1985/1931	28,575	60,325	19,355	15,875	19,845		0,26	29	NTN	
4T-1985/1932	28,575	58,738	19,355	15,080	19,355		0,23	29	NTN	
4T-1986	25,400		19,355				0,16	29	NTN	
4T-1986/1922	25,400	57,150	19,355	15,875	19,845		0,24	29	NTN	
4T-1986/1931	25,400	60,325	19,355	15,875	19,845		0,26	29	NTN	
4T-1988	28,575		19,355				0,14	29	NTN	
4T-1988/1922	28,575	57,150	19,355	15,875	19,845		0,21	29	NTN	
CRD-2005	100,000	215,000	105,000				19,70	31	NTN	
CRO-2008	100,000	170,000	155,000				14,50	32	NTN	
CRI-2010	100,000	180,000	140,000				13,80	30	NTN	
4T-M201011		73,025		21,336			0,17	29	NTN	
4T-M201047	39,688		22,098				0,26	29	NTN	
4T-M201047/M201011	39,688	73,025	22,098	21,336	25,654		0,43	29	NTN	
4T-M201047S	39,688		22,098				0,26	29	NTN	
CRD-2011	100,000	250,000	120,000				31,20	31	NTN	
4T-HM204010		91,000		26,500			0,31	29	NTN	
4T-HM204049	46,000		32,000				0,62	29	NTN	
4T-HM204049/HM204010	46,000	91,000	32,000	26,500	32,000		0,92	29	NTN	
4T-A2047	12,000		10,785				0,02	29	NTN	
4T-A2047/A2126	12,000	31,991	10,785	7,938	10,785		0,04	29	NTN	
CR-2051	100,000	170,000	43,000	37,000	45,500		4,20	29	NTN	
CRD-2051	100,000	250,000	116,000				26,80	31	NTN	
4T-JM205110		90,000		23,000			0,24	29	NTN	
4T-JM205149	50,000		28,000				0,51	29	NTN	
4T-JM205149/JM205110	50,000	90,000	28,000	23,000	28,000		0,75	29	NTN	
4T-JM205149A	50,000		28,000				0,50	29	NTN	
CRI-2052	100,000	165,000	52,000				3,94	30	NTN	
CRI-2054	100,000	215,000	115,000				18,20	30	NTN	

Reference						Kg	 Brands	
	d	D	B	C	T			
CRI-2059	100,000	180,000	82,000			8,08	30	NTN
4T-CR-2064DB	100,000	150,000	60,000			2,72	30	NTN
4T-JM207010		95,000		23,500		0,26	29	NTN
4T-JM207049	55,000		29,000			0,56	29	NTN
4T-JM207049/JM207010	55,000	95,000	29,000	23,500	29,000	0,82	29	NTN
4T-JM207049A	55,000		29,000			0,55	29	NTN
4T-CR1-2072	100,000	190,000	124,500			14,30	30	NTN
CRI-2072	100,000	190,000	124,500			14,30	30	NTN
CRI-20802	1 040,000	1 290,000	350,000			975,00	30	NTN
CR1-2088	100,000	215,000	162,000			26,70	30	NTN
CRI-2105	105,000	240,000	110,000			23,60	30	NTN
4T-21075	19,050		21,839			0,15	29	NTN
4T-21075/21212	19,050	53,975	21,839	15,875	22,225	0,25	29	NTN
4T-JH211710		120,000		32,000		0,61	29	NTN
4T-JH211749	65,000		38,500			1,22	29	NTN
4T-JH211749/JH211710	65,000	120,000	38,500	32,000	39,000	1,84	29	NTN
4T-HM212010		122,238		29,718		0,60	29	NTN
4T-HM212011		122,238		29,718		0,59	29	NTN
4T-HM212044	60,325		38,354			1,42	29	NTN
4T-HM212044/HM212011	60,325	122,238	38,354	29,718	38,100	2,02	29	NTN
4T-HM212046	63,500		38,354			1,35	29	NTN
4T-HM212046/HM212011	63,500	122,238	38,354	29,718	38,100	1,95	29	NTN
4T-HM212047	63,500		38,354			1,34	29	NTN
4T-HM212047/HM212010	63,500	122,238	38,354	29,718	38,354	1,92	29	NTN
4T-HM212047/HM212011	63,500	122,238	38,354	29,718	38,354	1,92	29	NTN
4T-HM212049	66,675		38,354			1,26	29	NTN
4T-HM212049/HM212010	66,675	122,238	38,354	29,718	38,354	1,86	29	NTN
4T-21212		53,975		15,875		0,10	29	NTN
4T-A2126		31,991		7,938		0,02	29	NTN
4T-H212710		124,000		34,000		0,68	29	NTN
4T-H212749	66,000		41,500			1,48	29	NTN
4T-H212749/H212710	66,000	124,000	41,500	34,000	41,500	2,14	29	NTN
CRD-2151	105,000	170,000	90,000			7,92	31	NTN
CRO-2151	105,000	190,000	210,000			26,00	32	NTN
4T-L21511		34,988		8,712		0,02	29	NTN
CRI-2152	105,000	190,000	117,000			12,90	30	NTN
4T-HM215210		132,000		32,000		0,66	29	NTN
4T-HM215249	76,000		39,000			1,43	29	NTN
4T-HM215249/HM215210	76,000	132,000	39,000	32,000	39,000	2,08	29	NTN
4T-L21549	15,875		11,000			0,03	29	NTN
4T-L21549/L21511	15,875	34,988	11,000	8,712	10,998	0,05	29	NTN
4T-JH217210		150,000		38,000		1,09	29	NTN
4T-JH217249	85,000		46,000			2,28	29	NTN
4T-JH217249/JH217210	85,000	150,000	46,000	38,000	46,000	3,36	29	NTN
4T-L217810		123,825		16,670		0,23	29	NTN
4T-L217849	88,900		20,638			0,50	29	NTN
4T-L217849/L217810	88,900	123,825	20,638	16,670	20,638	0,73	29	NTN
4T-LL217849/LL217810	88,900	121,442	15,083	11,112	15,083	0,45	29	NTN
4T-HM218210		147,000		32,500		0,78	29	NTN
4T-HM218238/HM218210	80,000	147,000	40,000	35,200	40,000	2,94	29	NTN
4T-HM218248	90,000		40,000			1,74	29	NTN
4T-HM218248/HM218210	90,000	147,000	40,000	32,500	40,000	2,52	29	NTN





Reference	d		D		B	C	T	Kg	Brands
	d	D	B	C	T				
T-EE219068/219117	174,625	298,450	82,550	63,500	82,550	21,10	29	NTN	
T-EE219068/219122	174,625	311,150	82,550	63,500	82,550	23,90	29	NTN	
4T-HM220110		157,000		34,000		0,87	29	NTN	
4T-HM220149	100,000		42,000			1,98	29	NTN	
4T-HM220149/HM220110	100,000	157,000	42,000	34,000	42,000	2,82	29	NTN	
4T-EH220749/EH220710	95,250	200,025	73,025	58,738	73,025	10,80	29	NTN	
EE221025D/221575+A	260,350	400,050	114,300			52,00	31	NTN	
EE221026/221575	260,350	400,050	67,470	46,038	69,850	27,00	29	NTN	
EE221026/221576D+A	260,350	400,050	155,575			62,70	30	NTN	
EE221027D/221575/221576D	260,350	400,050	255,588			117,00	32	NTN	
E-EE221027D/221575/221576D	260,350	400,050	255,588			117,00	32	NTN	
CRD-2214	110,000	240,000	118,000			26,60	31	NTN	
4T-HH221410		190,500		46,038		2,20	29	NTN	
4T-HH221430/HH221410	76,200	190,500	57,531	46,038	57,150	8,69	29	NTN	
4T-HH221431/HH221410	79,375	190,500	57,531	46,038	57,150	8,52	29	NTN	
4T-HH221434	88,900		57,531			5,85	29	NTN	
4T-HH221434/HH221410	88,900	190,500	57,531	46,038	57,531	7,94	29	NTN	
4T-HH221440/HH221410	95,250	190,500	57,531	46,038	57,150	7,50	29	NTN	
4T-HH221449	101,600		57,531			4,90	29	NTN	
4T-HH221449/HH221410	101,600	190,500	57,531	46,038	57,531	7,00	29	NTN	
4T-HH221449/HH221416	101,600	200,025	57,531	50,800	61,912	8,56	29	NTN	
4T-HH221449A/HH221410	101,600	190,500	57,531	46,038	57,150	7,06	29	NTN	
CRI-2219	110,000	180,000	125,000			11,20	30	NTN	
CR-2220	110,000	240,000	50,000	32,000	54,500	8,12	29	NTN	
EE222070/222127D+A	177,800	320,675	185,738			57,80	30	NTN	
CR-2226	110,000	200,000	48,000	32,000	51,000	5,69	29	NTN	
CRI-22303	1 115,000	1 460,000	300,000			1 255,00	30	NTN	
4T-HH224310		212,725		53,975		3,06	29	NTN	
4T-HH224334/HH224310	99,975	212,725	66,675	53,975	66,675	11,50	29	NTN	
4T-HH224335	101,600		66,675			8,26	29	NTN	
4T-HH224335/HH224310	101,600	212,725	66,675	53,975	66,675	11,32	29	NTN	
4T-HH224335/HH224310D+A	101,600	212,725	142,875			23,70	30	NTN	
4T-HH224346	114,300		66,675			7,13	29	NTN	
4T-HH224346/HH224310	114,300	212,725	66,675	53,975	66,675	10,20	29	NTN	
4T-HH224346NA/HH224310D	114,300	212,725	142,875			20,20	30	NTN	
4T-M224749/M224710D+A	120,650	174,625	77,788			5,76	30	NTN	
E-M224749D/M224710/M224710D	127,000	174,625	141,288			11,50	32	NTN	
M224749D/M224710/M224710D	120,650	174,625	141,288			11,50	32	NTN	
CRD-2252	110,000	190,000	102,000			12,10	31	NTN	
CRI-2252	110,000	240,000	119,000			25,00	30	NTN	
CR0-2252	110,000	150,000	150,000			7,70	32	NTN	
CRD-2254	110,000	200,000	82,000			11,30	31	NTN	
CR-2256	110,000	150,000	20,500	15,500	20,500	0,98	29	NTN	
4T-LL225749/LL225710	127,000	165,895	17,462	13,495	18,258	0,92	29	NTN	
CRI-2258	110,000	160,000	57,500			3,41	30	NTN	
4T-L225810		169,862		20,638		0,55	29	NTN	
4T-L225849	127,000		26,195			1,02	29	NTN	
4T-L225849/L225810	127,000	169,862	26,195	20,638	25,400	1,58	29	NTN	
CRI-2262	110,000	240,000	118,000			22,00	30	NTN	
4T-22720		82,550		20,638		0,22	29	NTN	
CR1-2272LL	110,000	200,000	100,000			13,60	30	NTN	
4T-22780	42,862		26,988			0,39	29	NTN	

Reference						Kg	?	Brands
	d	D	B	C	T			
4T-22780/22720	42,862	82,550	26,988	20,638	26,988	0,61	29	NTN
4T-HH228310		254,000		61,912		6,04	29	NTN
4T-HH228318		259,974		61,912		7,28	29	NTN
4T-HH228340	120,650		82,550			12,58	29	NTN
4T-HH228340/HH228310	120,650	254,000	82,550	61,912	77,788	19,20	29	NTN
4T-HH228344	123,825		82,550			12,30	29	NTN
4T-HH228349	127,000		82,550			13,46	29	NTN
4T-HH228349/HH228310	127,000	254,000	82,550	61,912	77,788	18,40	29	NTN
CR1-2290LL	110,000	190,000	249,400			24,50	30	NTN
CR1-2301	115,000	230,000	116,000			21,20	30	NTN
4T-23100	25,400		21,463			0,22	29	NTN
4T-23100/23256	25,400	65,088	21,463	15,875	22,225	0,36	29	NTN
4T-HM231132/HM231110	139,700	236,538	56,642	44,450	57,150	9,86	29	NTN
4T-HM231149/HM231110	149,225	236,538	56,642	44,450	57,150	8,94	29	NTN
T-EE231400/231975	355,600	501,650	66,675	50,800	74,612	44,90	29	NTN
T-EE231400/231976D+A	355,600	501,650	155,575			85,20	30	NTN
E-EE231400/231976D+A	355,600	501,650	155,575			85,20	30	NTN
T-EE231401D/231975+A	355,600	501,650	111,125			68,50	31	NTN
T-EE231462/231975	371,475	501,650	66,675	50,800	74,612	40,70	29	NTN
EE231462/231975	371,475	501,650	66,675	50,800	74,612	40,70	29	NTN
T-EE231462/231976D+A	371,475	501,650	155,575			77,30	30	NTN
EE231462/232026D+A	371,475	514,350	155,575			83,30	30	NTN
4T-M231610		222,250		34,925		1,88	29	NTN
T-HH231637/HH231615	127,000	295,275	87,312	57,150	82,550	27,10	29	NTN
4T-M231648/M231610	152,400	222,250	46,830	34,925	46,830	5,72	29	NTN
4T-M231649	152,400		46,830			3,89	29	NTN
4T-M231649/M231610	152,400	222,250	46,830	34,925	46,830	5,77	29	NTN
HH231649/HH231615	139,700	295,275	87,312	57,150	87,312	24,10	29	NTN
T-HH231649/HH231610	139,700	288,925	87,312	57,150	82,550	24,40	29	NTN
T-HH231649/HH231615	139,700	295,275	87,312	57,150	82,550	25,80	29	NTN
E-M231649D/M231610/M231610D	152,400	222,250	174,625			24,70	32	NTN
T-E-M231649D/M231610/M231610D	160,000	222,250	174,625			24,70	32	NTN
T-M231649D/M231610/M231610D	152,400	222,250	174,625			24,70	32	NTN
4T-23256		65,088		15,875		0,14	29	NTN
HH234010		307,975		66,675		8,69	29	NTN
HH234031	139,700		93,662			22,60	29	NTN
T-HH234031/HH234010	139,700	307,975	93,662	66,675	88,900	30,90	29	NTN
T-HH234031/HH234011D+A	139,700	307,975	200,025			65,90	30	NTN
E-HH234048/HH234010	152,400	307,975	93,662	66,675	88,900	29,40	29	NTN
HH234048/HH234010	152,400	307,975	93,662	66,675	93,662	28,10	29	NTN
T-HH234048/HH234010	152,400	307,975	93,662	66,675	88,900	29,40	29	NTN
T-HH234048/HM234011D+A	152,400	307,975	200,025			62,60	30	NTN
EE234156/234213D+A	396,875	539,750	142,875			83,60	30	NTN
EE234156/234215	396,875	546,100	61,120	55,562	76,200	51,50	29	NTN
EE234156/234216D+A	396,875	546,100	158,750			97,70	30	NTN
EE234160/234213D+A	406,400	539,750	142,875			78,80	30	NTN
EE234160/234215	406,400	546,100	61,120	55,562	76,200	48,70	29	NTN
EE234161D/234215/234216D	406,400	546,100	268,288			190,00	32	NTN
4T-23420		68,262		22,225		0,17	29	NTN
4T-23491	31,750		26,988			0,29	29	NTN
4T-M236810		260,350		41,275		2,86	29	NTN
E-M236848/M236810	177,800	260,350	53,975	41,275	53,975	9,28	29	NTN

Reference	D		B	C	T	Kg	?	Brands
	d	D	B	C	T			
4T-M236849	177,800		53,975			6,48	29	NTN
4T-M236849/M236810	177,800	260,350	53,975	41,275	53,975	9,34	29	NTN
4T-HM237510		288,925		47,625		4,49	29	NTN
T-HM237532/HM237510	160,325	288,925	63,500	47,625	63,500	16,00	29	NTN
T-HM237532/HM237510D+A	160,325	288,925	142,875			36,10	30	NTN
HM237535/HM237510	165,100	288,925	63,500	47,625	63,500	16,60	29	NTN
T-HM237535/HM237510	165,100	288,925	63,500	47,625	63,500	15,60	29	NTN
T-HM237535/HM237510D+A	165,100	288,925	142,875			35,10	30	NTN
T-HM237542/HM237510	174,625	288,925	63,500	47,625	63,500	14,70	29	NTN
T-HM237542/HM237510D+A	174,625	288,925	142,875			33,10	30	NTN
HM237545/HM237510D+A	177,800	288,925	142,875			32,10	30	NTN
E-HM237545/HM237510DC+A	177,800	288,925	142,875			32,96	30	NTN
T-HM237545/HM237510	177,800	288,925	63,500	47,625	63,500	14,40	29	NTN
T-HM237545/HM237510D+A	177,800	288,925	142,875			32,40	30	NTN
T-HM237545/HM237513	177,800	289,974	63,500	48,000	63,500	14,60	29	NTN
HM237545NA/HM237510CD	177,800	288,925	142,875			32,70	30	NTN
HM237546D/HM237510+A	177,800	288,925	123,825			29,40	31	NTN
T-HM237546D/HM237510+A	177,800	288,925	123,825			31,60	30	NTN
E-H238110		311,150		65,088		8,60	29	NTN
E-H238140	165,100		82,550			17,30	29	NTN
T-H238140/H238110	165,100	311,150	82,550	65,088	82,550	27,50	29	NTN
E-H238148/H238110	174,625	311,150	82,550	65,088	82,550	26,00	29	NTN
T-H238148/H238110	174,625	311,150	82,550	65,088	82,550	23,90	29	NTN
4T-M238810		269,875		42,862		3,12	29	NTN
4T-M238849	187,325		55,562			6,66	29	NTN
M238849/M238810	187,325	269,875	55,562	42,862	55,562	9,83	29	NTN
4T-M238849/M238810	187,325	269,875	55,562	42,862	55,562	9,83	29	NTN
E-M238849D/M238810/M238810D	187,325	269,875	211,138			41,80	32	NTN
M238849D/M238810/M238810D	187,325	269,875	211,138			41,80	32	NTN
H239640/H239610	177,800	319,964	85,725	65,088	88,900	28,00	29	NTN
T-H239640/H239610	177,800	319,964	85,725	65,088	88,900	30,20	29	NTN
T-H239640/H239612D+A	177,800	320,675	185,738			57,80	30	NTN
T-H239649/H239610	187,325	319,964	85,725	65,088	88,900	28,70	29	NTN
T-H239649/H239612	187,325	320,675	85,725	65,088	88,900	28,90	29	NTN
T-H239649/H239612D+A	187,325	320,675	185,738			55,00	30	NTN
T-H239649D/H239610+A	187,325	319,964	161,925			53,70	31	NTN
H239649NA/H239612CD	187,325	320,675	185,738			54,60	30	NTN
E-M240631T/M240644TD/M240647T/M240611D	180,843	284,162	239,715			50,90	32	NTN
M240648D/M240611/M240611D	198,438	284,162	225,425			46,00	32	NTN
CRD-2410	120,000	260,000	130,000			34,20	31	NTN
LM241149/LM241110	203,200	276,225	42,862	34,133	42,862	6,56	29	NTN
LM241149/LM241110D+A	203,200	276,225	90,485			13,80	30	NTN
E-M241538D/M241510/M241510D	190,000	292,100	225,425			59,60	32	NTN
M241538D/M241510/M241510D	190,000	292,100	225,425			59,60	32	NTN
T-M241543/M241510	200,025	292,100	57,945	46,038	57,945	11,50	29	NTN
T-M241543/M241510D+A	200,025	292,100	125,415			24,80	30	NTN
T-M241547/M241510	203,200	292,100	57,945	46,038	57,945	11,20	29	NTN
T-M241547/M241510D+A	203,200	292,100	125,415			24,10	30	NTN
T-M241549/M241510	204,788	292,100	57,945	46,038	57,945	11,00	29	NTN
T-M241549/M241510D+A	204,788	292,100	125,415			23,80	30	NTN
CR1-2416	120,000	200,000	100,000			12,57	30	NTN
CRI-2416	120,000	200,000	100,000			12,60	30	NTN





Reference						Kg	?	Brands
	d	D	B	C	T			
CR-2417	120,000	260,000	55,000	34,000	59,500	12,40	29	NTN
EE241701/242375	431,800	603,250	73,025	50,800	76,200	64,90	29	NTN
EE241701/242377D+A	431,800	603,250	159,639			124,00	30	NTN
CRO-2418	120,000	210,000	174,000			22,20	32	NTN
E-CRO-2418	120,650	210,000	174,000			22,20	32	NTN
4T-2420		68,288		17,462		0,14	29	NTN
CRD-2420	120,000	215,000	113,000			17,70	31	NTN
CRD-2421	120,000	170,000	120,000			8,57	31	NTN
CRD-2422	120,000	280,000	150,000			47,30	31	NTN
4T-H242610		336,550		77,788		11,00	29	NTN
4T-H242649	206,375		100,012			23,00	29	NTN
E-H242649/H242610CD	206,375	336,550	211,138			70,60	30	NTN
T-H242649/H242610	206,375	336,550	100,012	77,788	98,425	32,10	29	NTN
T-H242649/H242610D+A	206,375	336,550	211,138			65,20	30	NTN
T-H242649D/H242610+A	206,375	336,550	184,150			64,10	31	NTN
EE243190/243250	482,600	634,873	80,962	63,500	80,962	60,20	29	NTN
EE243190/243251D+A	482,600	634,873	177,800			148,00	30	NTN
EE243192/243250	489,026	634,873	80,962	63,500	80,962	58,00	29	NTN
EE243192/243251D+A	489,026	634,873	177,800			140,00	30	NTN
EE243196/243250	498,475	634,873	80,962	63,500	80,962	59,26	29	NTN
EE243196/243251D+A	498,475	634,873	177,800			129,00	30	NTN
EE244180/244235	457,200	596,900	73,025	53,975	76,200	50,87	29	NTN
EE244180/244236D+A	457,200	596,900	165,100			106,00	30	NTN
EE244181D/244235/244236D	457,200	596,900	276,225			207,00	32	NTN
4T-M244210		314,325		49,212		4,64	29	NTN
4T-M244249	220,662		61,912			9,83	29	NTN
4T-M244249/M244210	220,662	314,325	61,912	49,212	61,912	14,70	29	NTN
T-M244249/M244210	220,662	314,325	61,912	49,212	61,912	13,60	29	NTN
T-M244249/M244210D+A	220,662	314,325	131,762			28,90	30	NTN
T-E-M244249D/M244210/M244210D	220,662	314,325	239,712			60,20	32	NTN
T-M244249D/M244210/M244210D	220,662	314,325	239,712			60,20	32	NTN
T-M244249D/M244210+A	220,662	314,325	115,888			28,60	31	NTN
E-H244848TD/H244810A	202,405	358,826	200,100			79,82	31	NTN
E-H244848TD/H244810A+A	219,075	358,775	200,025			85,90	31	NTN
H244848TD/H244810A+A	202,406	358,775	200,025			85,00	31	NTN
H244849D/H244810A+A	219,075	358,775	200,025			79,50	31	NTN
4T-LM245846/LM245810	230,188	317,500	52,388	36,512	47,625	10,90	29	NTN
CRI-2460	120,000	200,000	78,000			8,78	30	NTN
CR-2465	120,000	180,000	48,000	29,000	48,000	7,10	29	NTN
4T-M246910		336,550		50,800		5,49	29	NTN
T-M246942/M246910	231,775	336,550	65,088	50,800	65,088	16,90	29	NTN
4T-M246949	237,330		65,088			12,00	29	NTN
T-M246949/M246910	237,330	336,550	65,088	50,800	65,088	16,20	29	NTN
4T-24720		76,200		17,462		0,15	29	NTN
4T-24721		76,200		20,638		0,19	29	NTN
4T-2474/2420	28,575	68,262	23,812	17,462	22,225	0,41	29	NTN
4T-2475	31,750		23,812			0,24	29	NTN
E-H247510		384,175		90,488		9,50	29	NTN
4T-H247510		384,175		90,488		16,90	29	NTN
E-H247535	200,025		112,712			36,10	29	NTN
E-H247535/H247510D+A	200,025	384,175	238,125			132,60	30	NTN
T-H247535/H247510	200,025	384,175	112,712	90,488	112,712	53,00	29	NTN

Reference	d		D		B	C	T	Kg	Brands
	d	D	B	C	T				
T-H247535/H247510D+A	200,025	384,175	238,125				112,00	30	NTN
4T-H247540	219,974		112,712				38,00	29	NTN
4T-H247549	234,950		112,712				33,30	29	NTN
H247549/H247510A	234,950	384,175	112,712	90,488	112,712		52,00	29	NTN
E-H247549/H247510CD+A	234,950	384,175	238,125				104,00	30	NTN
T-H247549/H247510	234,950	384,175	112,712	90,488	112,712		45,50	29	NTN
T-H247549/H247510D+A	234,950	384,175	238,125				96,20	30	NTN
H247549D/H247510+A	234,950	384,175	209,550				98,00	31	NTN
E-LM247748D/LM247710/LM247710DA	244,475	327,025	193,675				46,10	32	NTN
LM247748D/LM247710/LM247710DA	244,475	327,025	193,675				46,10	32	NTN
LM247748D/LM247710A+A	244,475	327,025	92,075				21,40	31	NTN
NA24776SW/K97753ZZ	38,100	101,600	58,735				2,77	30	NTN
4T-24780	41,275		23,020				0,28	29	NTN
4T-24780/24720	41,275	76,200	23,020	17,462	23,020		0,43	29	NTN
4T-24780/24721	41,275	76,200	23,020	20,638	25,400		0,47	29	NTN
E-H249148/H249111DC+A	241,300	406,400	215,900				107,84	30	NTN
T-H249148/H249111D+A	241,300	406,400	215,900				101,00	30	NTN
4T-M249710		358,775		53,975			6,51	29	NTN
T-M249732/M249710	228,600	358,775	71,438	53,975	71,438		23,90	29	NTN
T-M249732/M249710D+A	228,600	358,775	152,400				50,90	30	NTN
4T-M249734	231,775		71,438				16,90	29	NTN
T-M249734/M249710	231,775	358,775	71,438	53,975	71,438		23,40	29	NTN
T-M249734/M249710D+A	231,775	358,775	152,400				50,00	30	NTN
T-M249736/M249710	237,330	358,775	71,438	53,975	71,438		22,60	29	NTN
T-M249736/M249710D+A	237,330	358,775	152,400				48,20	30	NTN
E-M249746TD/M249710UP	241,564	358,775	139,700				42,20	31	NTN
T-E-M249748D/M249710/M249710D	254,000	358,775	269,875				85,60	32	NTN
T-M249748D/M249710/M249710D	254,000	358,775	269,875				85,60	32	NTN
T-M249748D/M249710+A	254,000	358,775	130,175				41,20	31	NTN
E-M249749/M249710	254,000	358,775	71,438	53,975	71,438		21,48	29	NTN
M249749/M249710	254,000	358,775	71,438	53,975	71,438		21,50	29	NTN
M249749/M249710CD+A	254,000	358,775	152,400				44,70	30	NTN
M249749/M249710D+A	254,000	358,775	152,400				44,70	30	NTN
T-M249749/M249710	254,000	358,775	71,438	53,975	71,438		20,10	29	NTN
T-M249749/M249710D+A	254,000	358,775	152,400				42,80	30	NTN
E-M249749D/M249710/M249710D	254,000	258,775	269,875				74,40	32	NTN
CR1-2498	120,000	165,000	68,000				3,97	30	NTN
HH249949/HH249910	247,650	406,400	117,475	93,662	117,475		42,80	29	NTN
HH249949/HH249910D+A	247,650	406,400	247,650				112,00	30	NTN
HH249949D/HH249910+A	247,650	406,400	219,075				112,00	31	NTN
CRD-2503	125,000	305,000	180,000				68,90	31	NTN
CRT2503	127,000	266,700	58,738				17,70	37	NTN
CR-2503DF	125,000	305,000	180,000				63,90	30	NTN
4T-2520		66,421		20,638			0,12	29	NTN
4T-2523		69,850		19,050			0,17	29	NTN
4T-M252310		381,000		57,150			7,72	29	NTN
T-M252330/M252310	234,950	381,000	74,612	57,150	74,612		29,30	29	NTN
T-M252337/M252310	247,650	381,000	74,612	57,150	74,612		27,30	29	NTN
T-HM252343/HM252310	254,000	422,275	79,771	66,675	86,121		47,10	29	NTN
T-HM252343/HM252310D+A	254,000	422,275	178,592				88,90	30	NTN
T-HM252348/HM252310	260,350	422,275	79,771	66,675	86,121		45,70	29	NTN
T-HM252348/HM252310D+A	260,350	422,275	178,592				86,30	30	NTN





Reference						Kg	?	Brands
	d	D	B	C	T			
4T-M252349	269,875		74,612			17,60	29	NTN
M252349/M252310D+A	269,875	381,000	158,750			52,30	30	NTN
T-M252349/M252310	269,875	381,000	74,612	57,150	74,612	25,40	29	NTN
T-M252349/M252310D+A	269,875	381,000	158,750			52,30	30	NTN
E-HM252349D/HM252310/HM252310D	260,350	422,275	314,325			180,00	32	NTN
HM252349D/HM252310/HM252310D	260,350	422,275	136,525	123,825	314,325	180,00	32	NTN
E-M252349D/M252310/M252310D	269,875	381,000	282,575			97,50	32	NTN
T-M252349D/M252310/M252310D	269,875	381,000	282,575			97,50	32	NTN
T-M252349D/M252310+A	269,875	381,000	136,525			48,60	31	NTN
4T-2523S		69,850		19,050		0,17	29	NTN
HH255149D/HH255110+A	279,400	457,200	244,475			158,00	31	NTN
HH255149TD/HH255110+A	259,027	457,200	244,475			165,43	31	NTN
4T-25519		82,550		19,050		0,19	29	NTN
4T-25520		82,931		19,050		0,20	29	NTN
4T-25521		83,058		19,050		0,20	29	NTN
4T-25522		83,058		19,114		0,20	29	NTN
4T-25523		82,931		22,225		0,23	29	NTN
4T-25526		85,027		19,050		0,24	29	NTN
4T-CR1-2554	125,000	230,000	116,000			19,00	30	NTN
CRI-2554	125,000	230,000	116,000			19,90	30	NTN
M255449/M255410A	288,925	406,400	77,788	60,325	77,788	27,80	29	NTN
M255449/M255410DA+A	288,925	406,400	165,100			59,00	30	NTN
E-M255449D/M255410/M255410DA	288,925	406,400	298,450			125,00	32	NTN
M255449D/M255410/M255410DA	288,925	406,400	298,450			125,00	32	NTN
E-M255449D/M255410A+A	288,925	406,400	144,462			59,00	31	NTN
M255449D/M255410A+A	288,925	406,400	144,462			58,10	31	NTN
E-M255449TD/M255410AUP	276,887	406,400	144,462			62,00	31	NTN
CRI-2555	125,000	210,000	110,000			14,50	30	NTN
4T-25572	38,112		25,400			0,44	29	NTN
4T-25572/25520	38,100	82,931	25,400	19,050	23,812	0,65	29	NTN
4T-25577	42,875		25,400			0,38	29	NTN
4T-25577/25520	42,875	82,931	25,400	19,050	25,400	0,58	29	NTN
4T-25577/25521	42,875	83,058	25,400	19,050	25,400	0,57	29	NTN
4T-25577/25522	42,875	83,058	25,400	19,114	25,400	0,58	29	NTN
4T-25577/25523	42,875	82,931	25,400	22,225	26,988	0,62	29	NTN
4T-25578	42,862		25,400			0,38	29	NTN
4T-25578/25520	42,862	82,931	25,400	19,050	23,812	0,58	29	NTN
4T-2558	30,162		25,357			0,30	29	NTN
4T-2558/2523	30,162	69,850	25,357	19,050	23,812	0,47	29	NTN
4T-2558/2523S	30,162	69,850	25,357	19,050	23,812	0,46	29	NTN
4T-25580	44,450		25,400			0,35	29	NTN
4T-25580/25520	44,450	82,931	25,400	19,050	25,400	0,56	29	NTN
4T-25580/25521	44,450	83,058	25,400	19,050	25,400	0,55	29	NTN
4T-25580/25522	44,450	83,058	25,400	19,114	25,400	0,56	29	NTN
4T-25580/25523	44,450	82,931	25,400	22,225	26,988	0,60	29	NTN
4T-25581	44,463		25,476			0,36	29	NTN
4T-25581/25520	44,450	82,931	25,476	19,050	25,400	0,56	29	NTN
4T-25582/25520	44,450	82,931	25,400	19,050	23,812	0,56	29	NTN
4T-25583	44,450		35,878			0,44	29	NTN
4T-25584	44,983		25,400			0,35	29	NTN
4T-25584/25520	44,983	82,931	25,400	19,050	25,400	0,55	29	NTN
4T-25584/25521	44,983	83,058	25,400	19,050	25,400	0,55	29	NTN







Reference						Kg	?	Brands
	d	D	B	C	T			
4T-25590	45,618		25,400			0,34	29	NTN
4T-25590/25519	45,618	82,550	25,400	19,050	23,812	0,53	29	NTN
4T-25590/25520	45,618	82,931	25,400	19,050	25,400	0,54	29	NTN
4T-25590/25521	45,618	83,058	25,400	19,050	25,400	0,53	29	NTN
4T-25590/25522	45,618	83,058	25,400	19,114	23,876	0,55	29	NTN
4T-25590/25523	45,618	82,931	25,400	22,225	26,988	0,56	29	NTN
4T-25590/25526	45,618	85,000	25,400	19,050	23,812	0,58	29	NTN
4T-25592/25520	46,038	82,931	25,400	19,050	23,812	0,54	29	NTN
E-HM256849/HM256810D+A	300,038	422,275	174,625			69,20	30	NTN
T-HM256849/HM256810DG2+A	300,038	422,275	174,625			67,40	30	NTN
T-HM256849/HM256810G2	300,038	422,275	82,550	63,500	82,550	31,90	29	NTN
T-E-HM256849D/HM256810/HM256810DG2	300,038	422,275	311,150			143,00	32	NTN
T-HM256849D/HM256810/HM256810DG2	300,038	422,275	311,150			143,00	32	NTN
T-HM256849D/HM256810G2+A	300,038	422,275	150,812			65,60	31	NTN
E-M257149D/M257110/M257110D	304,800	419,100	269,875			115,00	32	NTN
M257149D/M257110/M257110D	304,800	419,100	269,875			115,00	32	NTN
M257149D/M257110+A	304,800	419,100	130,175			53,10	31	NTN
E-M257248D/M257210/M257210D	304,902	412,648	266,700			107,00	32	NTN
M257248D/M257210/M257210D	304,902	412,648	266,700			107,00	32	NTN
M257248D/M257210+A	304,902	412,648	128,588			49,00	31	NTN
4T-2578	28,575		25,357			0,31	29	NTN
4T-2578/2523	28,575	69,850	25,357	19,050	25,357	0,48	29	NTN
4T-2580	31,750		25,357			0,28	29	NTN
4T-2580/2520	31,750	66,421	25,357	20,638	25,400	0,41	29	NTN
4T-2580/2523	31,750	69,850	25,357	19,050	23,812	0,45	29	NTN
4T-2580/2523S	31,750	69,850	25,357	19,050	25,357	0,45	29	NTN
4T-2581	33,338		25,357			0,27	29	NTN
4T-2582	31,750		25,357			0,28	29	NTN
4T-2582/2523	31,750	69,850	25,357	19,050	25,357	0,45	29	NTN
4T-25820		73,025		19,050		0,16	29	NTN
4T-25821		73,025		19,050		0,17	29	NTN
E-HH258248/HH258210	300,000	495,350	141,288	114,300	141,288	96,00	29	NTN
HH258248/HH258210DG2+A	299,974	495,300	301,625			205,00	30	NTN
HH258248/HH258210G2	299,974	495,300	141,288	114,300	141,288	96,00	29	NTN
E-HH258249TD/HH258210+A	281,252	495,300	263,525			225,00	31	NTN
4T-2585	33,338		25,357			0,26	29	NTN
4T-2585/2520	33,338	66,421	25,357	20,638	25,400	0,38	29	NTN
4T-2585/2523	33,338	69,850	25,357	19,050	25,357	0,43	29	NTN
LM258648D/LM258610+A	317,500	422,275	128,588			49,10	31	NTN
E-LM258649D/LM258610/LM258610D	317,500	422,275	269,875			110,00	32	NTN
LM258649D/LM258610/LM258610D (CRO-6431)	317,500	422,275	269,875			110,00	32	NTN
4T-25877	34,925		24,608			0,30	29	NTN
4T-25877/25820	34,925	73,025	24,608	19,050	24,608	0,46	29	NTN
4T-25877/25821	34,925	73,025	24,608	19,050	24,608	0,47	29	NTN
4T-25878	34,925		24,608			0,30	29	NTN
4T-25878/25820	34,925	73,025	24,608	19,050	24,608	0,46	29	NTN
4T-25880	36,487		24,608			0,29	29	NTN
4T-25880/25820	36,487	73,025	24,608	19,050	24,608	0,45	29	NTN
4T-25880/25821	36,487	73,025	24,608	19,050	24,608	0,45	29	NTN
E-HM259010		447,675		68,262		12,80	29	NTN
E-HM259048/HM259010	317,500	447,675	85,725	68,262	85,725	40,20	29	NTN
T-HM259048/HM259010	317,500	447,675	87,725	68,262	85,725	37,30	29	NTN

Reference						Kg		Brands
	d	D	B	C	T			
4T-HM259049/HM259010	317,500	447,675	85,725	68,262	85,725	40,20	29	NTN
HM259049/HM259010D+A	317,500	447,675	85,725	150,812	180,975	83,18	30	NTN
T-HM259049/HM259010D+A	317,500	447,675	180,975			78,80	30	NTN
HM259049D/HM259010+A	317,500	447,675	158,750			78,90	31	NTN
T-E-HM259049D/HM259010/HM259010D	317,500	447,675	327,025			161,00	32	NTN
T-HM259049D/HM259010/HM259010D	317,500	447,675	158,750	146,050	327,025	161,00	32	NTN
T-HM259049D/HM259010+A	317,500	447,675	158,750			77,90	32	NTN
HM261049/HM261010A	333,375	469,900	90,488	71,438	90,488	43,40	29	NTN
E-HM261049/HM261010DA+A	333,375	469,900	190,500			91,30	30	NTN
HM261049/HM261010DA+A	333,375	469,900	190,500			91,30	30	NTN
E-HM261049D/HM261010/HM261010D	333,375	496,900	342,900			186,15	32	NTN
HM261049D/HM261010/HM261010DA	333,375	469,900	342,900			187,00	32	NTN
HM261049D/HM261010A+A	333,375	469,900	166,688			90,10	31	NTN
CRI-2614	130,000	230,000	95,000			15,00	30	NTN
CR-2615	130,000	280,000	58,000	36,000	63,750	15,20	29	NTN
CR-2615DF	130,000	280,000	220,500			37,50	30	NTN
CRI-2616	130,000	230,000	145,000			23,00	30	NTN
CR1-2618	130,000	280,000	137,000			33,70	30	NTN
CRI-2618	130,000	280,000	137,000			34,50	30	NTN
CRI-2619	130,000	210,000	109,000			14,20	30	NTN
4T-2620		63,100		19,050		0,11	29	NTN
CR1-2624	130,000	299,000	137,000			43,70	30	NTN
CR1-2624	130,000	299,000	137,000			45,80	30	NTN
E-M262449D/M262410/M262410D	347,662	469,900	292,100			148,00	32	NTN
M262449D/M262410/M262410D	347,662	469,900	292,100			148,00	32	NTN
M262449D/M262410+A	347,662	469,900	138,112			68,00	31	NTN
E-HM262710		488,950		74,612		16,70	29	NTN
4T-HM262748	346,075		95,250			37,10	29	NTN
T-HM262748/HM262710	346,075	488,950	95,250	74,612	95,249	52,50	29	NTN
E-HM262749/HM262710	346,075	488,950	95,250	74,612	95,250	53,80	29	NTN
E-HM262749/HM262710CD+A	346,075	488,950	200,025			111,00	30	NTN
E-HM262749/HM262710D+A	346,075	488,950	200,025			104,00	30	NTN
T-HM262749/HM262710DG2+A	346,075	488,950	200,025			104,00	30	NTN
T-HM262749/HM262710G2	346,075	488,950	95,250	74,612	95,250	49,70	29	NTN
T-E-HM262749D/HM262710/HM262710DG2	346,075	488,950	358,775			227,00	32	NTN
T-HM262749D/HM262710/HM262710DG2	346,075	488,950	358,775			227,00	32	NTN
T-HM262749D/HM262710G2+A	346,075	488,950	174,625			103,00	31	NTN
4T-2631		66,421		19,050		0,16	29	NTN
E-LM263149D/LM263110/LM263110D	355,600	457,200	252,412			106,00	32	NTN
LM263149D/LM263110/LM263110D	355,600	457,200	252,412			106,00	32	NTN
LM263149D/LM263110+A	355,600	457,200	120,650			49,10	31	NTN
E-M263349D/M263310/M263310D	355,600	488,950	317,500			173,00	32	NTN
M263349D/M263310/M263310D	355,600	488,950	317,500			173,00	32	NTN
M263349D/M263310+A	355,600	488,950	153,988			85,40	31	NTN
E-CR1-2648LL	131,750	207,962	129,550	135,900	190,500	20,00	30	NTN
E-HM265049/HM265010	368,249	523,875	101,600	79,375	101,600	65,00	29	NTN
HM265049/HM265010DG2+A	368,249	523,875	101,600	169,862	214,312	142,00	30	NTN
HM265049/HM265010G2	368,249	523,875	101,600	79,375	101,600	61,70	29	NTN
E-HM265049D/HM265010/HM265010DG2	368,300	523,875	382,588			280,00	32	NTN
HM265049D/HM265010/HM265010DG2 (CRO-7406)	368,300	523,875	382,588			280,00	32	NTN
E-HM265049D/HM265010+A	368,300	523,875	185,738			133,00	31	NTN
HM265049D/HM265010G2+A	368,300	523,875	185,738			130,00	31	NTN





Reference	d		D		B	C	T	Kg	?	Brands
	d	D	B	C	T					
E-HM265049TD/HM265010	352,822	523,875	185,738					136,00	31	NTN
CRI-2651	130,000	214,000	115,000					15,50	30	NTN
CRD-2652	130,000	190,000	120,000					11,40	31	NTN
CRD-2654	130,000	195,000	120,000					12,50	31	NTN
CRI-2654	130,000	230,000	149,000					24,60	30	NTN
CRI-2655	130,000	230,000	100,000					15,80	30	NTN
CRI-2663	128,000	229,000	116,000					17,80	30	NTN
4T-HM266410		546,100		82,550				23,60	29	NTN
T-HM266446/HM266410	381,000	546,100	104,775	82,550	104,775			76,00	29	NTN
T-HM266446/HM266410D+A	381,000	546,100	222,250					149,00	30	NTN
T-HM266447/HM266410G2	381,000	546,100	104,775	82,550	104,775		70,10	29	NTN	
E-HM266448/HM266410	384,175	546,100	104,775	82,550	104,775		74,50	29	NTN	
T-HM266448/HM266410	384,175	546,100	104,775	82,550	104,775		69,00	29	NTN	
T-HM266448/HM266410D+A	384,175	546,100	222,250				146,00	30	NTN	
HM266449/HM266410	384,175	546,100	104,775	82,550	104,775		74,50	29	NTN	
HM266449/HM266410DC+A	384,175	546,100	222,250				156,42	30	NTN	
T-HM266449/HM266410DG2+A	384,175	546,100	222,250				146,00	30	NTN	
T-HM266449/HM266410G2	384,175	546,100	104,775	82,550	104,775		69,00	29	NTN	
E-HM266449D/HM266410/HM266410D	384,175	546,100	400,050				336,00	32	NTN	
T-E-HM266449D/HM266410/HM266410DG2	384,175	546,100	400,050				312,00	32	NTN	
T-HM266449D/HM266410/HM266410DG2	384,175	546,100	400,050				312,00	32	NTN	
T-HM266449D/HM266410G2+A	384,175	546,100	193,675				153,00	31	NTN	
HM266449TD/HM266410	384,175	546,100	193,675				152,00	31	NTN	
4T-JL26710		53,000		11,500			0,04	29	NTN	
4T-JL26749	32,000		15,000				0,08	29	NTN	
4T-JL26749/JL26710	32,000	53,000	15,000	11,500	14,500		0,12	29	NTN	
4T-2682/2631	26,162	66,421	25,433	19,050	23,812		0,44	29	NTN	
4T-26820		80,167		20,638			0,21	29	NTN	
4T-26822		79,375		19,050			0,19	29	NTN	
4T-26823		76,200		20,638			0,14	29	NTN	
4T-26824		80,000		19,050			0,20	29	NTN	
4T-26830		80,167		20,638			0,22	29	NTN	
4T-2687	25,400		25,433				0,28	29	NTN	
4T-2687/2620	25,400	63,100	25,433	19,050	23,812		0,39	29	NTN	
4T-2687/2631	25,400	66,421	25,433	19,050	25,433		0,44	29	NTN	
T-M268730/M268710DG2+A	381,000	590,550	244,475				247,00	30	NTN	
T-M268730/M268710G2	381,000	590,550	114,300	88,900	114,300		102,00	29	NTN	
E-M268749/M268710	415,925	590,550	114,300	88,900	114,300		97,90	29	NTN	
T-M268749/M268710DG2+A	415,925	590,550	244,475				188,00	30	NTN	
T-M268749/M268710G2	415,925	590,550	114,300	88,900	114,300		87,80	29	NTN	
T-E-M268749D/M268710/M268710DG2	415,925	590,550	434,975				421,00	32	NTN	
T-M268749D/M268710/M268710DG2	415,925	590,550	434,975				421,00	32	NTN	
T-M268749D/M268710G2+A	415,925	590,550	209,550				181,00	31	NTN	
E-M268749TD/M268710+A	398,462	590,550	209,550				207,00	31	NTN	
4T-26878	38,100		25,400				0,39	29	NTN	
4T-26878/26822	38,100	79,375	25,400	19,050	23,812		0,57	29	NTN	
4T-26878/26824	38,100	80,000	25,400	19,050	25,400		0,58	29	NTN	
4T-2688	26,988		25,433				0,25	29	NTN	
4T-26880	39,688		25,400				0,37	29	NTN	
4T-26880/26822	39,688	79,375	25,400	19,050	23,812		0,55	29	NTN	
4T-26881	39,688		25,400				0,37	29	NTN	
4T-26881/26822	39,688	79,375	25,400	19,050	25,400		0,55	29	NTN	

Reference						Kg	?	Brands
	d	D	B	C	T			
4T-26882	41,275		25,400			0,34	29	NTN
4T-26882/26820	41,275	80,167	25,400	20,638	25,400	0,56	29	NTN
4T-26882/26822	41,275	79,375	25,400	19,050	25,400	0,53	29	NTN
4T-26882/26823	41,275	76,200	25,400	20,638	25,400	0,49	29	NTN
4T-26882/26824	41,275	80,000	25,400	19,050	23,812	0,54	29	NTN
4T-26882T	41,275		25,400			0,36	29	NTN
4T-26882T/26822	41,275	79,375	25,400	19,050	25,400	0,71	29	NTN
4T-26883	35,000		25,400			0,42	29	NTN
4T-26883/26822	35,000	79,375	25,400	19,050	25,400	0,60	29	NTN
4T-26884	42,875		25,400			0,32	29	NTN
4T-26884/26822	42,875	79,375	25,400	19,050	25,400	0,51	29	NTN
4T-26884/26824	42,875	80,000	25,400	19,050	25,400	0,52	29	NTN
4T-26885/26822	41,275	79,375	25,400	19,050	23,812	0,54	29	NTN
4T-26886	42,875		25,400			0,33	29	NTN
4T-26886/26824	42,875	80,000	25,400	19,050	23,812	0,53	29	NTN
4T-26886/26830	42,875	80,167	25,400	20,638	25,400	0,55	29	NTN
4T-26889	28,575		25,433			0,25	29	NTN
4T-26889/2631	28,575	66,421	25,433	19,050	25,433	0,41	29	NTN
4T-2690	29,367		25,433			0,24	29	NTN
4T-2690/2631	29,367	66,421	25,433	19,050	23,812	0,41	29	NTN
CRO-2701	135,000	180,000	160,000			13,50	32	NTN
E-CRO-2701	136,525	180,000	160,000			13,50	32	NTN
M270749/M270710AG2	447,675	635,000	120,650	95,250	120,650	107,00	29	NTN
M270749/M270710DAG2+A	447,675	635,000	257,175			228,00	30	NTN
E-M270749D/M270710/M270710DAG2	447,675	635,000	463,550			509,00	32	NTN
M270749D/M270710/M270710DG2	447,675	635,000	463,550			509,00	32	NTN
M270749D/M270710+A	447,675	635,000	223,838			234,00	31	NTN
M270749D/M270710AG2+A	447,675	635,000	223,838			224,00	31	NTN
E-M270749TD/M270710AUP	444,675	635,000	223,838			254,00	31	NTN
4T-2720		76,200		19,050		0,18	29	NTN
LM272235/LM272210G2	457,200	615,950	85,725	66,675	85,725	63,80	29	NTN
E-LM272249/LM272210D+A	482,600	615,950	184,150			118,00	30	NTN
LM272249/LM272210DG2+A	482,600	615,950	184,150			118,00	30	NTN
LM272249/LM272210G2	482,600	615,950	85,725	66,675	85,725	54,90	29	NTN
E-LM272249D/LM272210/LM272210DG2	482,600	615,950	330,200			250,00	32	NTN
LM272249D/LM272210/LM272210DG2	482,600	615,950	330,200			250,00	32	NTN
LM272249D/LM272210G2+A	482,600	615,950	158,750			115,00	31	NTN
M272647D/M272610G2+A	482,600	647,700	201,612			185,00	31	NTN
T-M272749/M272710DG2+A	479,425	679,450	276,225			310,00	30	NTN
T-M272749/M272710G2	479,425	679,450	128,588	101,600	128,588	130,00	29	NTN
E-M272749D/M272710+A	479,425	679,450	238,125			293,00	31	NTN
M272749D/M272710+A	479,425	679,450	238,125			272,00	31	NTN
T-M272749D/M272710G2+A	479,425	679,450	238,125			293,00	31	NTN
4T-2729		76,200		19,050		0,19	29	NTN
4T-2729X		76,200		19,050		0,19	29	NTN
4T-2735X		73,025		19,050		0,14	29	NTN
M274149/M274110G2	501,650	711,200	136,525	106,362	136,525	152,00	29	NTN
E-M274149D/M274110/M274110DG2	501,650	711,200	520,700			726,00	32	NTN
M274149D/M274110/M274110DG2	501,650	711,200	520,700			726,00	32	NTN
M274149D/M274110G2+A	501,650	711,200	250,825			314,00	31	NTN
E-LM274449D/LM274410/LM274410D	514,350	673,100	422,275			390,00	32	NTN
LM274449D/LM274410/LM274410D	514,350	673,100	422,275			390,00	32	NTN





Reference	d		D		B	C	T	Kg	Brands	
	d	D	B	C	T	?				
LM274449D/LM274410+A	514,350	673,100	203,200				189,00	31	NTN	
T-EE275095/275155	241,300	393,700	69,850	50,005	73,817		34,30	29	NTN	
T-EE275095/275156D+A	241,300	393,700	157,162				66,50	30	NTN	
T-EE275100/275155	254,000	393,700	69,850	50,005	73,817		32,10	29	NTN	
T-EE275100/275156D+A	254,000	393,700	157,162				62,20	30	NTN	
T-EE275105/275155	266,700	393,700	69,850	50,005	73,817		29,70	29	NTN	
T-EE275105/275156D+A	266,700	393,700	157,162				57,60	30	NTN	
EE275106D/275155/275156D	266,700	393,700	269,878				116,00	32	NTN	
E-EE275106D/275155/275156D	266,700	393,700	269,878				116,00	32	NTN	
T-EE275108/275155	273,050	393,700	69,850	50,005	73,817		28,50	29	NTN	
T-EE275108/275156D+A	273,050	393,700	157,162				55,30	30	NTN	
T-EE275109D/275155+A	276,225	393,700	130,175				50,50	30	NTN	
EE275109D/275160/275161D	276,225	406,400	268,290				122,00	32	NTN	
E-EE275109D/275160/275161D	276,225	406,400	268,290				122,00	32	NTN	
E-M275349D/M275310/M275310DG2	519,112	736,600	536,575				761,00	32	NTN	
M275349D/M275310/M275310DG2 (CRO-10408)	519,112	736,600	536,575				761,00	32	NTN	
M275349D/M275310G2+A	519,112	736,600	258,762				348,00	31	NTN	
4T-27620		125,412		19,845			0,34	29	NTN	
M276448D/M276410G2+A	536,575	761,873	269,875				389,00	31	NTN	
M276449/M276410DG2+A	536,575	761,873	146,050	247,650	311,150		398,00	30	NTN	
M276449/M276410G2	536,575	761,873	146,050	114,300	146,050		187,00	29	NTN	
E-M276449D/M276410/M276410DG2	536,575	761,873	558,800				890,00	32	NTN	
M276449D/M276410/M276410DG2	536,575	761,873	558,800				890,00	32	NTN	
M276449D/M276410G2+A	536,575	761,873	269,875				389,00	31	NTN	
4T-27687	82,550		25,400				0,70	29	NTN	
4T-27687/27620	82,550	125,412	25,400	19,845	25,400		1,07	29	NTN	
4T-27689/27620	83,345	125,412	25,400	19,845	25,400		1,06	29	NTN	
4T-27690	83,345		25,400				0,68	29	NTN	
4T-27690/27620	83,345	125,412	25,400	19,845	25,400		1,05	29	NTN	
4T-27691/27620	83,345	125,412	25,400	19,845	25,400		1,04	29	NTN	
4T-27695	84,975		25,400				0,63	29	NTN	
4T-27695/27620	84,975	125,412	25,400	19,845	25,400		0,97	29	NTN	
E-EE277455/277565	1 155,700	1 435,100	120,650	95,250	120,650		428,00	29	NTN	
4T-2776	38,100		25,654				0,31	29	NTN	
4T-2776/2720	38,100	76,200	25,654	19,050	23,812		0,50	29	NTN	
4T-2777	38,100		25,654				0,30	29	NTN	
4T-2780	36,487		25,654				0,33	29	NTN	
4T-2780/2720	36,487	76,200	25,654	19,050	25,654		0,51	29	NTN	
4T-27820		80,035		18,512			0,21	29	NTN	
4T-2785	33,338		25,654				0,36	29	NTN	
4T-2785/2720	33,338	76,200	25,654	19,050	23,812		0,55	29	NTN	
M278749/M278710AG2	571,500	812,800	155,575	120,650	155,575		227,00	29	NTN	
M278749/M278710DAG2+A	571,500	812,800	333,375				487,00	30	NTN	
E-M278749D/M278710/M278710DAG2	571,500	812,800	593,725				1 080,00	32	NTN	
M278749D/M278710/M278710DAG2	571,500	812,800	593,725				1 080,00	32	NTN	
M278749D/M278710AG2+A	571,500	812,800	285,750				470,00	31	NTN	
4T-27875	34,925		23,698				0,38	29	NTN	
4T-2788	38,100		25,654				0,31	29	NTN	
4T-2788/2720	38,100	76,200	25,654	19,050	23,812		0,50	29	NTN	
4T-2788/2729	38,100	76,200	25,654	19,050	25,654		0,49	29	NTN	
4T-2788/2735X	38,100	73,025	25,654	19,050	23,812		0,44	29	NTN	
4T-27880	38,100		23,698				0,35	29	NTN	







Reference						Kg	?	Brands
	d	D	B	C	T			
4T-27880/27820	38,100	80,035	23,698	18,512	24,608	0,56	29	NTN
4T-27881	38,100		23,698			0,35	29	NTN
4T-27881/27820	38,100	80,035	23,698	18,512	24,608	0,56	29	NTN
E-LM278849D/LM278810/LM278810D	585,788	771,525	479,425			750,00	32	NTN
LM278849D/LM278810/LM278810D	585,788	771,525	479,425			750,00	32	NTN
4T-2788A	38,100		25,654			0,31	29	NTN
4T-2789	39,688		25,654			0,29	29	NTN
4T-2789/2720	39,688	76,200	25,654	19,050	25,654	0,47	29	NTN
4T-2789/2729	39,688	76,200	25,654	19,050	25,654	0,47	29	NTN
4T-2790	33,338		25,654			0,36	29	NTN
4T-2790/2720	33,338	76,200	25,654	19,050	25,654	0,54	29	NTN
4T-2793	34,925		25,654			0,35	29	NTN
4T-2793/2720	34,925	76,200	25,654	19,050	25,654	0,53	29	NTN
4T-2793/2729	34,925	76,200	25,654	19,050	23,812	0,54	29	NTN
4T-2793/2735X	34,925	73,025	25,654	19,050	23,812	0,49	29	NTN
4T-2794	36,487		25,654			0,32	29	NTN
4T-2796	34,925		25,654			0,34	29	NTN
4T-2796/2720	34,925	76,200	25,654	19,050	25,654	0,53	29	NTN
CRD-28003	1 400,000	1 600,000	180,000			534,00	31	NTN
E-M280049D/M280010/M280010DG2	595,312	844,550	615,950			1 160,00	32	NTN
M280049D/M280010/M280010DG2	595,312	844,550	615,950			1 160,00	32	NTN
M280049D/M280010G2+A	595,312	844,550	296,862			525,00	31	NTN
M280349D/M280310/M280310DG2	609,600	863,600	660,400			1 250,00	32	NTN
M280349D/M280310G2+A	609,600	863,600	317,500			585,00	31	NTN
EE280626/281200	158,750	304,800	69,106	42,862	66,675	20,80	29	NTN
E-EE280700D/281200/281201D	177,800	304,800	238,227			69,90	32	NTN
EE280700D/281200/281201D (CRO-3663)	177,800	304,800	238,227			69,90	32	NTN
E-LM281031T/LM281044TD/LM281048T/LM2	595,312	857,250	590,550			1 020,00	32	NTN
M281049D/M281010G2+A	635,000	901,700	317,500			641,00	31	NTN
CRO-2810LL	140,000	198,000	174,000			16,00	32	NTN
L281148/L281110A	660,400	812,800	95,250	73,025	95,250	93,50	29	NTN
L281148/L281110DA+A	660,400	812,800	203,200			199,00	30	NTN
E-L281149D/L281110/L281110DG2	660,400	812,800	365,125			448,00	32	NTN
L281149D/L281110/L281110DG2	660,400	812,800	365,125			448,00	32	NTN
L281149D/L281110G2+A	660,400	812,800	176,212			195,00	31	NTN
CRO-2812LL	140,000	198,000	174,000			15,50	32	NTN
4T-28137	34,925		20,940			0,27	29	NTN
4T-28137/28317	34,925	80,035	20,940	15,875	21,433	0,47	29	NTN
4T-28150	38,100		20,940			0,26	29	NTN
4T-28150/28300	38,100	76,200	20,940	15,507	20,940	0,40	29	NTN
4T-28150/28315	38,100	80,000	20,940	15,875	21,006	0,47	29	NTN
4T-28156	39,980		19,649			0,23	29	NTN
4T-28158	40,000		20,940			0,25	29	NTN
4T-28158/28300	40,000	76,200	20,940	15,507	20,940	0,38	29	NTN
E-M281649D/M281610/M281610DG2	657,225	933,450	676,275			1 630,00	32	NTN
M281649D/M281610/M281610DG2	657,225	933,450	676,275			1 630,00	32	NTN
M281649D/M281610G2+A	657,225	933,450	328,612			711,00	31	NTN
CRO-2817	140,000	210,000	115,000			13,90	32	NTN
CR1-2818	140,000	210,000	106,000			12,60	30	NTN
CRI-2818	140,000	210,000	106,000			12,50	30	NTN
E-LM281849D/LM281810/LM281810DG2	679,450	901,700	552,450			1 040,00	32	NTN
LM281849D/LM281810/LM281810DG2	679,450	901,700	552,450			1 040,00	32	NTN

Reference	d		D		B	C	T	Kg	?	Brands
	d	D	B	C	T					
LM281849D/LM281810G2+A	679,450	901,700	265,112					459,00	31	NTN
CRD-2819	140,000	305,000	160,000					58,10	31	NTN
4T-2820		73,025			17,462			0,15	29	NTN
E-M282249D/M282210/M282210DG2	682,625	965,200	701,675					1 770,00	32	NTN
M282249D/M282210/M282210DG2	682,625	965,200	701,675					1 770,00	32	NTN
CRI-2825	140,000	230,000	140,000					20,50	30	NTN
LM282549D/LM282510G2+A	708,025	930,275	273,050					490,00	31	NTN
CRI-2826	140,000	260,000	120,000					26,60	30	NTN
4T-28300		76,200			15,507			0,14	29	NTN
CR-2831	140,000	210,000	55,000	34,000	55,000			4,30	29	NTN
4T-28317		80,035			15,875			0,20	29	NTN
CR1-2834	140,000	300,000	102,000					32,50	30	NTN
CRI-2834	140,000	300,000	102,000					32,50	30	NTN
M283449D/M283410/M283410D	730,250	1 035,050	755,650					2 210,00	31	NTN
E-M283449D/M283410/M283410DG2	730,250	1 035,050	755,650					2 210,00	32	NTN
LM283649/LM283610G2	749,300	990,600	160,337	123,000	159,500			309,00	29	NTN
E-LM283649D/LM283610/LM283610DG2	749,300	990,600	605,000					1 310,00	32	NTN
LM283649D/LM283610/LM283610DG2	749,300	990,600	605,000					1 250,00	32	NTN
LM283649D/LM283610G2+A	749,300	990,600	293,000					606,00	31	NTN
M284148D/M284111/M284110DG2	762,000	1 066,800	723,900					2 220,00	32	NTN
M284148D/M284111G2+A	762,000	1 066,800	352,425					968,00	31	NTN
E-M284249D/M284210/M284210DG2	762,000	1 079,500	787,400					2 480,00	32	NTN
M284249D/M284210/M284210DG2	762,000	1 079,500	787,400					2 480,00	32	NTN
M284249D/M284210G2+A	762,000	1 079,500	381,000					1 097,00	31	NTN
4T-28520		89,980			19,987			0,20	29	NTN
4T-28521		92,075			19,845			0,24	29	NTN
CRI-2855	140,000	230,000	120,000					15,50	30	NTN
4T-28579	49,987		25,400					0,46	29	NTN
4T-28580	50,800		25,400					0,45	29	NTN
4T-28580/28520	50,800	89,980	25,400	19,987	25,400			0,65	29	NTN
4T-28580/28521	50,800	92,075	25,400	19,845	25,400			0,70	29	NTN
4T-28584	52,388		25,400					0,43	29	NTN
4T-28584/28521	52,388	92,075	25,400	19,845	25,400			0,67	29	NTN
E-M285848D/M285810/M285810DG2	825,500	1 168,400	844,550					3 010,00	32	NTN
M285848D/M285810/M285810DG2	825,500	1 168,400	844,550					3 010,00	32	NTN
4T-28622		97,630			19,446			0,27	29	NTN
E-LM286249D/LM286210/LM286210DG2	863,600	1 130,300	669,925					1 950,00	32	NTN
LM286249D/LM286210/LM286210DG2	863,600	1 130,300	669,925					1 950,00	32	NTN
LM286249D/LM286210G2+A	863,600	1 130,300	323,850					848,00	31	NTN
4T-28678	50,800		24,608					0,58	29	NTN
4T-28678/28622	50,800	97,630	24,608	19,446	24,608			0,85	29	NTN
4T-28680	55,562		24,608					0,50	29	NTN
4T-28680/28622	55,562	97,630	24,608	19,446	24,608			0,77	29	NTN
4T-28682	57,150		24,608					0,47	29	NTN
4T-28682/28622	57,150	97,630	24,608	19,446	24,608			0,74	29	NTN
CRI-2869	140,000	240,000	132,000					22,10	30	NTN
4T-CR1-2869C3	140,000	240,000	132,000					22,10	30	NTN
CRI-2872	140,000	225,000	85,000					11,80	30	NTN
CRI-2874	140,000	270,000	120,000					27,60	30	NTN
E-LM287649D/LM287610/LM287610DG2	938,212	1 270,000	825,500					4 100,00	32	NTN
LM287649D/LM287610/LM287610DG2	938,212	1 270,000	825,500					4 100,00	32	NTN
LM287649D/LM287610G2+A	938,212	1 270,000	400,050					1 444,00	31	NTN

Reference						Kg	?	Brands
	d	D	B	C	T			
4T-2878	34,925		23,812			0,28	29	NTN
4T-2878/2820	34,925	73,025	23,812	17,462	22,225	0,43	29	NTN
LM287849D/LM287810G2+A	939,800	1 333,500	349,250			1 540,00	31	NTN
4T-2879	31,750		23,812			0,32	29	NTN
4T-2879/2820	31,750	73,025	23,812	17,462	22,225	0,47	29	NTN
CR1-2884L	140,000	250,000	153,000			30,10	30	NTN
4T-28880/28820E1	247,650	304,800	22,225	15,875	22,225	3,29	29	NTN
E-LM288949D/LM288910/LM288910DG2	1 200,150	1 593,850	990,600			6 130,00	32	NTN
LM288949D/LM288910/LM288910DG2	1 200,150	1 593,850	990,600			6 130,00	32	NTN
4T-28919		99,979		19,050		0,22	29	NTN
4T-28920		101,600		19,845		0,27	29	NTN
4T-28921		100,000		19,845		0,23	29	NTN
4T-28980	59,977		25,400			0,53	29	NTN
4T-28985	60,325		25,400			0,53	29	NTN
4T-28985/28920	60,325	101,600	25,400	19,845	25,400	0,80	29	NTN
4T-28985/28921	60,325	100,000	25,400	19,845	25,400	0,77	29	NTN
4T-28990	61,976		24,608			0,49	29	NTN
4T-28990/28919	61,976	99,979	24,608	19,050	24,608	0,71	29	NTN
4T-28990/28920	61,976	101,600	24,608	19,845	25,400	0,77	29	NTN
4T-28995	62,738		25,400			0,49	29	NTN
4T-28995/28920	62,738	101,600	25,400	19,845	25,400	0,76	29	NTN
4T-28995/28921	62,738	100,000	25,400	19,845	25,400	0,71	29	NTN
EE291175/291750	298,450	444,500	61,912	39,688	63,500	33,10	29	NTN
EE291175/291751D+A	298,450	444,500	146,050			69,30	30	NTN
EE291200D/291750+A	304,800	444,500	107,950			55,70	30	NTN
EE291201/291750	304,800	444,500	61,912	39,688	63,500	31,90	29	NTN
EE291201/291751D+A	304,800	444,500	146,050			66,80	30	NTN
EE291202D/291750/291751D	304,800	444,500	247,650			127,00	32	NTN
E-EE291202D/291750/291751D	304,800	444,500	247,650			127,00	32	NTN
E-EE291250	317,500		61,912			17,00	29	NTN
EE291250/291750	317,500	444,500	61,912	39,688	63,500	29,50	29	NTN
EE291250/291751D+A	317,500	444,500	146,050			61,80	30	NTN
4T-2924		85,000		20,638		0,22	29	NTN
EE295102/295192D+A	260,350	488,950	254,000			190,00	30	NTN
EE295102/295193	260,350	488,950	120,650	92,075	120,650	90,30	29	NTN
EE295110/295192D+A	279,400	488,950	254,000			179,00	30	NTN
EE295110/295193	279,400	488,950	120,650	92,075	120,650	84,90	29	NTN
4T-29520		107,950		19,050		0,27	29	NTN
4T-29521		110,000		19,050		0,33	29	NTN
4T-29522		107,950		19,050		0,28	29	NTN
4T-29580	60,000		25,400			0,71	29	NTN
4T-29580/29520	60,000	107,950	25,400	19,050	25,400	0,99	29	NTN
4T-29582	60,013		25,400			0,72	29	NTN
4T-29585	63,500		25,400			0,64	29	NTN
4T-29585/29520	63,500	107,950	25,400	19,050	25,400	0,91	29	NTN
4T-29585/29521	63,500	110,000	25,400	19,050	25,400	0,98	29	NTN
4T-29586	63,500		25,400			0,65	29	NTN
4T-29586/29520	63,500	107,950	25,400	19,050	25,400	0,92	29	NTN
4T-29586/29522	63,500	107,950	25,400	19,050	25,400	0,96	29	NTN
4T-29590	66,675		25,400			0,58	29	NTN
4T-29590/29520	66,675	107,950	25,400	19,050	25,400	0,85	29	NTN
4T-29590/29521	66,675	110,000	25,400	19,050	25,400	0,91	29	NTN





Reference	d		D		B	C	T	Kg	Brands
	d	D	B	C	T				
4T-29590/29522	66,675	107,950	25,400	19,050	25,400	0,86	29	NTN	
4T-29620		112,712		19,050		0,27	29	NTN	
4T-29630		120,650		19,050		0,48	29	NTN	
4T-29675	69,850		25,400			0,67	29	NTN	
4T-29675/29620	69,850	112,712	25,400	19,050	25,400	0,95	29	NTN	
4T-29675/29630	69,850	120,650	25,400	19,050	25,400	1,17	29	NTN	
4T-29685	73,025		25,400			0,60	29	NTN	
4T-29685/29620	73,025	112,712	25,400	19,050	25,400	0,86	29	NTN	
4T-29685/29622D+A	73,025	114,287	58,738			2,09	30	NTN	
4T-29688	73,817		25,400			0,59	29	NTN	
4T-29688/29620	73,817	112,712	25,400	19,050	25,400	0,86	29	NTN	
4T-LM29710		65,088		13,970		0,08	29	NTN	
4T-LM29711		65,088		15,748		0,09	29	NTN	
4T-LM29748	38,100		18,288			0,15	29	NTN	
4T-LM29748/LM29710	38,100	65,088	18,288	13,970	18,034	0,23	29	NTN	
4T-LM29748L	38,100		18,288			0,16	29	NTN	
4T-LM29748L/LM29710	38,100	65,088	18,288	13,970	18,821	0,24	29	NTN	
4T-LM29749	38,100		18,288			0,16	29	NTN	
4T-LM29749/LM29710	38,100	65,088	18,288	13,970	18,034	0,23	29	NTN	
4T-LM29749/LM29711	38,100	65,088	18,288	15,748	19,812	0,25	29	NTN	
4T-2984	46,038		25,608			0,39	29	NTN	
4T-2984/2924	46,038	85,000	25,608	20,638	25,608	0,61	29	NTN	
29875/29820	254,000	323,850	22,225	15,875	22,225	3,92	29	NTN	
29875/29820D+A	254,000	323,850	63,500			11,20	30	NTN	
29880/29820	266,700	323,850	22,225	15,875	22,225	3,52	29	NTN	
29880/29820D+A	266,700	323,850	63,500			9,37	30	NTN	
4T-LM300811		68,000		13,500		0,08	29	NTN	
4T-LM300849	41,000		18,000			0,16	29	NTN	
4T-LM300849/LM300811	41,000	68,000	18,000	13,500	18,000	0,24	29	NTN	
CRD-3011	150,000	380,000	235,000			142,00	31	NTN	
CRD-3013	150,000	320,000	144,000			56,90	31	NTN	
CRI-3015	150,000	250,000	115,000			21,20	30	NTN	
CRD-3016	150,000	320,000	144,000			53,00	31	NTN	
E-CRT3018	152,400	317,500	69,850			28,20	37	NTN	
302/28	28,000	58,000	16,000	14,000	17,250	0,20	29	NTN	
302/32	32,000	65,000	17,000	15,000	18,250	0,18	29	NTN	
30202 A	15,000	35,000	11,000	10,000	11,750	0,05	29	SNR	
30203	17,000	40,000	12,000	11,000	13,250	0,08	29	NTN	
30203 A	17,000	40,000	12,000	11,000	13,250	0,08	29	SNR	
30204	20,000	47,000	14,000	12,000	15,250	0,13	29	NTN	
30204 A	20,000	47,000	14,000	12,000	15,250	0,12	29	SNR	
30205	25,000	52,000	15,000	13,000	16,250	0,15	29	NTN	
30205 A	25,000	52,000	15,000	13,000	16,250	0,16	29	SNR	
30206	30,000	62,000	16,000	14,000	17,250	0,24	29	NTN	
30206 A	30,000	62,000	16,000	14,000	17,250	0,24	29	SNR	
30207	35,000	72,000	17,000	15,000	18,250	0,34	29	NTN	
30207 A	35,000	72,000	17,000	15,000	18,250	0,35	29	SNR	
30208	40,000	80,000	18,000	16,000	19,750	0,44	29	NTN	
30208 A	40,000	80,000	18,000	16,000	19,750	0,44	29	SNR	
30209	45,000	85,000	19,000	16,000	20,750	0,49	29	NTN	
30209 C	45,000	85,000	19,000	16,000	20,750	0,48	29	SNR	
4T-30209DF	45,000	85,000	41,500			1,02	30	NTN	

Reference						Kg	?	Brands
	d	D	B	C	T			
30210	50,000	90,000	20,000	17,000	21,750	0,55	29	NTN
30210 C	50,000	90,000	20,000	17,000	21,750	0,55	29	SNR
30211	55,000	100,000	21,000	18,000	22,750	0,74	29	NTN
30211 A	55,000	100,000	21,000	18,000	22,750	0,80	29	SNR
30212	60,000	110,000	22,000	19,000	23,750	0,92	29	NTN
30212 A	60,000	110,000	22,000	19,000	23,750	0,92	29	SNR
30213	65,000	120,000	23,000	20,000	24,750	1,18	29	NTN
30213 A	65,000	120,000	23,000	20,000	24,750	1,15	29	SNR
30213 C	65,000	120,000	23,000	20,000	24,750	1,15	29	SNR
30214	70,000	125,000	24,000	21,000	26,250	1,28	29	NTN
30214 A	70,000	125,000	24,000	21,000	26,250	1,30	29	SNR
30214UDF	70,000	125,000	26,250			2,69	30	NTN
30215	75,000	130,000	25,000	22,000	27,250	1,41	29	NTN
30215 A	75,000	130,000	25,000	22,000	27,250	1,40	29	SNR
30215 C	75,000	130,000	25,000	22,000	27,250	1,39	29	SNR
4T-30215DF	75,000	130,000	54,500			2,85	30	NTN
30216	80,000	140,000	26,000	22,000	28,250	1,68	29	NTN
30216 A	80,000	140,000	26,000	22,000	28,250	1,74	29	SNR
30217	85,000	150,000	28,000	24,000	30,500	2,10	29	NTN
30217 A	85,000	150,000	28,000	24,000	30,500	2,14	29	SNR
30217UDF	85,000	150,000	61,000			4,46	30	NTN
30218	90,000	160,000	30,000	26,000	32,500	2,64	29	NTN
30218 A	90,000	160,000	30,000	26,000	32,500	2,63	29	SNR
4T-30218DF	90,000	160,000	65,000			5,47	30	NTN
30219	95,000	170,000	32,000	27,000	34,500	3,07	29	NTN
30219 A	95,000	170,000	32,000	27,000	34,500	3,15	29	SNR
30219UDF	95,000	170,000	69,000			6,45	30	NTN
30220	100,000	180,000	34,000	29,000	37,000	3,78	29	NTN
30220 A	100,000	180,000	34,000	29,000	37,000	3,79	29	SNR
4T-30220DFC3	100,000	180,000	74,000			7,80	30	NTN
30220UDF	100,000	180,000	74,000			7,56	30	NTN
30221	105,000	190,000	36,000	30,000	39,000	4,39	29	NTN
30221 A	105,000	190,000	36,000	30,000	39,000	4,46	29	SNR
30221UDF	105,000	190,000	78,000			9,24	30	NTN
30222	110,000	200,000	38,000	32,000	41,000	5,00	29	NTN
30222 A	110,000	200,000	38,000	32,000	41,000	5,14	29	SNR
30224	120,000	215,000	40,000	34,000	43,500	6,23	29	NTN
30224 A	120,000	215,000	40,000	34,000	43,500	6,25	29	SNR
30224UDF	120,000	215,000	87,000			13,10	30	NTN
30226	130,000	230,000	40,000	34,000	43,750	7,00	29	NTN
30226 A	130,000	230,000	40,000	34,000	43,750	7,16	29	SNR
30228	140,000	250,000	42,000	36,000	45,750	9,26	29	NTN
30228 A	140,000	250,000	42,000	36,000	45,750	8,87	29	SNR
30230	150,000	270,000	45,000	38,000	49,000	10,90	29	NTN
30230 A	150,000	270,000	45,000	38,000	49,000	11,20	29	SNR
30232	160,000	290,000	48,000	40,000	52,000	12,90	29	NTN
30234	170,000	310,000	52,000	43,000	57,000	17,00	29	NTN
30236	180,000	320,000	52,000	43,000	57,000	17,70	29	NTN
30238	190,000	340,000	55,000	46,000	60,000	21,20	29	NTN
30240	200,000	360,000	58,000	48,000	64,000	25,40	29	NTN
30244	220,000	400,000	65,000	54,000	72,000	34,40	29	NTN
30244DF	220,000	400,000	144,000			70,00	30	NTN







							Brands	
Reference	d	D	B	C	T	Kg		
30248	240,000	440,000	72,000	60,000	79,000	47,70	29	NTN
30252	260,000	480,000	80,000	67,000	89,000	63,40	29	NTN
30256	280,000	500,000	80,000	67,000	89,000	66,60	29	NTN
30260	300,000	540,000	85,000	71,000	96,000	83,10	29	NTN
30264	320,000	580,000	92,000	75,000	104,000	103,90	29	NTN
30302	15,000	42,000	13,000	11,000	14,250	0,10	29	NTN
30303	17,000	47,000	14,000	12,000	15,250	0,13	29	NTN
30303 A	17,000	47,000	14,000	12,000	15,250	0,13	29	SNR
30304 A	20,000	52,000	15,000	13,000	16,250	0,18	29	SNR
30304CA	20,000	52,000	16,000	12,000	16,250	0,17	29	NTN
30305	25,000	62,000	17,000	15,000	18,250	0,27	29	NTN
30305 A	25,000	62,000	17,000	15,000	18,250	0,27	29	SNR
30305C	25,000	62,000	17,000	14,000	18,250	0,26	29	NTN
30305 C	25,000	62,000	17,000	15,000	18,250	0,26	29	SNR
30305D	25,000	62,000	17,000	13,000	18,250	0,25	29	NTN
4T-30305DF	25,000	62,000	-			0,55	30	NTN
30306	30,000	72,000	19,000	16,000	20,750	0,40	29	NTN
30306 A	30,000	72,000	19,000	16,000	20,750	0,42	29	SNR
30306D	30,000	72,000	19,000	14,000	20,750	0,40	29	NTN
30307	35,000	80,000	21,000	18,000	22,750	0,53	29	NTN
30307 A	35,000	80,000	21,000	18,000	22,750	0,54	29	SNR
30307C	35,000	80,000	21,000	17,000	22,750	0,52	29	NTN
30307D	35,000	80,000	21,000	15,000	22,750	0,52	29	NTN
30308	40,000	90,000	23,000	20,000	25,250	0,77	29	NTN
30308 A	40,000	90,000	23,000	20,000	25,250	0,78	29	SNR
30308C	40,000	90,000	23,000	19,000	25,250	0,73	29	NTN
30308D	40,000	90,000	23,000	17,000	25,250	0,74	29	NTN
4T-30308DDF	40,000	90,000	50,500			1,49	30	NTN
30309	45,000	100,000	25,000	22,000	27,250	1,00	29	NTN
30309 A	45,000	100,000	25,000	22,000	27,250	1,00	29	SNR
30309D	45,000	100,000	25,000	18,000	27,250	0,96	29	NTN
4T-30309DDF	45,000	100,000	54,500			2,00	30	NTN
30310	50,000	110,000	27,000	23,000	29,250	1,29	29	NTN
30310 A	50,000	110,000	27,000	23,000	29,250	1,29	29	SNR
30310D	50,000	110,000	27,000	19,000	29,250	1,25	29	NTN
4T-30310DDF	50,000	110,000	58,500			2,59	30	NTN
30311	55,000	120,000	29,000	25,000	31,500	1,63	29	NTN
30311 A	55,000	120,000	29,000	25,000	31,500	1,64	29	SNR
30311D	55,000	120,000	29,000	21,000	31,500	1,59	29	NTN
4T-30311DDF	55,000	120,000	63,000			3,34	30	NTN
30312	60,000	130,000	31,000	26,000	33,500	2,04	29	NTN
30312 A	60,000	130,000	31,000	26,000	33,500	2,06	29	SNR
30312D	60,000	130,000	31,000	22,000	33,500	1,97	29	NTN
4T-30312DDF	60,000	130,000	67,000			4,09	30	NTN
30313	65,000	140,000	33,000	28,000	36,000	2,50	29	NTN
30313 A	65,000	140,000	33,000	28,000	36,000	2,47	29	SNR
30313D	65,000	140,000	33,000	23,000	36,000	2,42	29	NTN
4T-30313DDF	65,000	140,000	72,000			4,13	30	NTN
30314	70,000	150,000	35,000	30,000	38,000	3,02	29	NTN
30314 A	70,000	150,000	35,000	30,000	38,000	3,05	29	SNR
30314D	70,000	150,000	35,000	25,000	38,000	2,88	29	NTN
4T-30314DDF	70,000	150,000	76,000			6,20	30	NTN



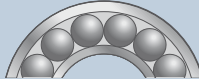



Reference	d		D		B	C	T	Kg	?	Brands
	d	D	B	C	T					
30314UDF	70,000	150,000	76,000				6,14	30	NTN	
30315	75,000	160,000	37,000	31,000	40,000		3,54	29	NTN	
30315 A	75,000	160,000	37,000	31,000	40,000		3,57	29	SNR	
30315D	75,000	160,000	37,000	26,000	40,000		3,54	29	NTN	
30315DUDF	75,000	160,000	80,000				7,20	30	NTN	
30316	80,000	170,000	39,000	33,000	42,500		4,41	29	NTN	
30316 A	80,000	170,000	39,000	33,000	42,500		4,36	29	SNR	
30316D	80,000	170,000	39,000	27,000	42,500		4,11	29	NTN	
30316DUDF	80,000	170,000	85,000				8,46	30	NTN	
30317	85,000	180,000	41,000	34,000	44,500		5,20	29	NTN	
30317D	85,000	180,000	41,000	28,000	44,500		4,85	29	NTN	
30317DUDF	85,000	180,000	89,000				10,20	30	NTN	
30318	90,000	190,000	43,000	36,000	46,500		6,03	29	NTN	
30318D	90,000	190,000	43,000	30,000	46,500		5,66	29	NTN	
30319	95,000	200,000	45,000	38,000	49,500		6,62	29	NTN	
30319D	95,000	200,000	45,000	32,000	49,500		6,47	29	NTN	
30319UDF	95,000	200,000	99,000				14,12	30	NTN	
30320	100,000	215,000	47,000	39,000	51,500		8,56	29	NTN	
30320	100,000	215,000	47,000	39,000	51,500		7,72	29	NTN	
30321	105,000	225,000	49,000	41,000	53,500		9,79	29	NTN	
30322	110,000	240,000	50,000	42,000	54,500		11,10	29	NTN	
30324	120,000	260,000	55,000	46,000	59,500		14,20	29	NTN	
30326	130,000	280,000	58,000	49,000	63,750		17,10	29	NTN	
30328	140,000	300,000	62,000	53,000	67,750		21,10	29	NTN	
30330	150,000	320,000	65,000	55,000	72,000		25,50	29	NTN	
30332	160,000	340,000	68,000	58,000	75,000		29,90	29	NTN	
30332UDF	160,000	340,000	150,000				63,30	30	NTN	
30334	170,000	360,000	72,000	62,000	80,000		35,30	29	NTN	
30336	180,000	380,000	75,000	64,000	83,000		40,20	29	NTN	
30338	190,000	400,000	78,000	65,000	86,000		43,50	29	NTN	
30340	200,000	420,000	80,000	67,000	89,000		51,00	29	NTN	
30344	220,000	460,000	88,000	73,000	97,000		66,70	29	NTN	
30348	240,000	500,000	95,000	80,000	105,000		87,20	29	NTN	
30348DF	240,000	500,000	95,000	80,000	210,000		174,00	29	NTN	
CRD-3052	150,000	250,000	110,000				21,70	31	NTN	
CRO-3052	150,000	210,000	190,000				20,30	32	NTN	
CRO-3058	150,000	210,000	190,000				21,08	32	NTN	
CRI-3061	150,000	250,000	137,000				27,70	30	NTN	
CRI-3063	150,000	260,000	150,000				31,40	30	NTN	
CRI-3069	150,000	380,000	260,000				146,00	30	NTN	
4T-JH307710		110,000		32,000			0,56	29	NTN	
4T-JH307749	55,000		39,000				1,11	29	NTN	
4T-JH307749/JH307710	55,000	110,000	39,000	32,000	39,000		1,67	29	NTN	
E-E30902/131401D+A	228,600	355,600	152,400				49,50	30	NTN	
CRI-3101	155,000	330,000	180,000				66,00	30	NTN	
CR-3105DB	154,000	210,000	90,000				8,13	30	NTN	
4T-3120		72,626		23,812			0,22	29	NTN	
4T-3130		72,652		23,812			0,23	29	NTN	
31304	20,000	52,000	15,000	11,000	16,250		0,17	29	SNR	
31305 V	25,000	62,000	17,000	13,000	18,250		0,26	29	SNR	
31306 A	30,000	72,000	19,000	14,000	20,750		0,41	29	SNR	
31307 A	35,000	80,000	21,000	15,000	22,750		0,55	29	SNR	

Reference	D		B	C	T	Kg		Brands
	d	D	B	C	T			
31308 A	40,000	90,000	23,000	17,000	25,250	0,76	29	SNR
31309 A	45,000	100,000	25,000	18,000	27,250	0,96	29	SNR
31310 A	50,000	110,000	27,000	19,000	29,250	1,24	29	SNR
31311 A	55,000	120,000	29,000	21,000	31,500	1,58	29	SNR
31312 A	60,000	130,000	31,000	22,000	33,500	2,00	29	SNR
31312 VB22	60,000	130,000	31,000	22,000	33,500	1,89	29	SNR
31313 A	65,000	140,000	33,000	23,000	36,000	2,47	29	SNR
31314 A	70,000	150,000	35,000	25,000	38,000	2,95	29	SNR
31320X	100,000	215,000	51,000	35,000	56,500	8,67	29	NTN
31321X	105,000	225,000	53,000	36,000	58,000	9,68	29	NTN
31322X	110,000	240,000	57,000	38,000	63,000	11,90	29	NTN
31322XUDF	110,000	240,000	126,000			25,90	30	NTN
31324X	120,000	260,000	62,000	42,000	68,000	15,90	29	NTN
31324XUDF	120,000	260,000	136,000			31,80	30	NTN
31326X	130,000	280,000	66,000	44,000	72,000	19,00	29	NTN
31326XUDF	130,000	280,000	144,000			41,00	30	NTN
31328X	140,000	300,000	70,000	47,000	77,000	23,00	29	NTN
31328XUDF	140,000	300,000	154,000			49,70	30	NTN
31330X	150,000	320,000	75,000	50,000	82,000	27,70	29	NTN
4T-31520		76,200		23,812		0,23	29	NTN
4T-31521		76,200		23,812		0,24	29	NTN
4T-31593	34,925		28,575			0,39	29	NTN
4T-31593/31520	34,925	76,200	28,575	23,812	29,370	0,63	29	NTN
4T-31594	34,575		28,575			0,39	29	NTN
4T-31594/31520	34,925	76,200	28,575	23,812	29,370	0,63	29	NTN
4T-31597	36,512		28,575			0,37	29	NTN
4T-31597/31520	36,512	76,200	28,575	23,812	29,370	0,61	29	NTN
4T-JHM318410		155,000		35,500		1,02	29	NTN
4T-JHM318448	90,000		44,000			2,31	29	NTN
4T-JHM318448/JHM318410	90,000	155,000	44,000	35,500	44,000	3,33	29	NTN
4T-3187/3120	30,162	72,626	29,997	23,812	30,162	0,62	29	NTN
4T-3188	31,750		29,997			0,38	29	NTN
4T-3188/3120	31,750	72,626	29,997	23,812	30,162	0,60	29	NTN
4T-3188S	31,750		29,997			0,38	29	NTN
4T-3188S/3120	31,750	72,626	29,997	23,812	30,162	0,60	29	NTN
4T-L319210		130,175		16,670		0,25	29	NTN
4T-L319249	95,250		21,433			0,53	29	NTN
4T-L319249/L319210	95,250	130,175	21,433	16,670	21,433	0,78	29	NTN
4T-3193	31,750		29,997			0,38	29	NTN
4T-3193/3120	31,750	72,626	29,997	23,812	30,162	0,60	29	NTN
4T-LL319349/LL319310	95,250	128,588	15,083	11,908	15,875	0,52	29	NTN
4T-3196	33,338		29,997			0,35	29	NTN
4T-3196/3120	33,338	72,626	29,997	23,812	30,162	0,58	29	NTN
4T-3198	28,575		29,997			0,41	29	NTN
320/22X	22,000	44,000	15,000	11,500	15,000	0,10	29	NTN
320/28X	28,000	52,000	16,000	12,000	16,000	0,15	29	NTN
320/32X	32,000	58,000	17,000	13,000	17,000	0,19	29	NTN
32004X	20,000	42,000	15,000	12,000	15,000	0,10	29	NTN
4T-32004XDF	20,000	42,000	30,000			0,20	30	NTN
32005X	25,000	47,000	15,000	11,500	15,000	0,11	29	NTN
32006X	30,000	55,000	17,000	13,000	17,000	0,17	29	NTN
32006XT2LX3	30,000	55,000	17,000	13,000	17,000	0,17	29	NTN





Reference						Kg	?	Brands
	d	D	B	C	T			
32007 C	35,000	62,000	18,000	14,000	18,000	0,23	29	SNR
32007X	35,000	62,000	18,000	14,000	18,000	0,22	29	NTN
32008 C	40,000	68,000	19,000	14,500	19,000	0,27	29	SNR
32008X	40,000	68,000	19,000	14,500	19,000	0,27	29	NTN
32009X	45,000	75,000	2,000	15,500	20,000	0,33	29	NTN
CR1-3201	160,000	270,000	140,000			32,00	30	NTN
32010 A	50,000	80,000	20,000	15,500	20,000	0,36	29	SNR
32010X	50,000	80,000	20,000	15,500	20,000	0,37	29	NTN
32011 A	55,000	90,000	23,000	17,500	23,000	0,59	29	SNR
32011X	55,000	90,000	23,000	17,500	23,000	0,56	29	NTN
32012 A	60,000	95,000	23,000	17,500	23,000	0,63	29	SNR
32012X	60,000	95,000	23,000	17,500	23,000	0,58	29	NTN
32013 A	65,000	100,000	23,000	17,500	23,000	0,67	29	SNR
32013X	65,000	100,000	23,000	17,500	23,000	0,63	29	NTN
32014 A	70,000	110,000	25,000	19,000	25,000	0,90	29	SNR
32014X	70,000	110,000	25,000	19,000	25,000	0,85	29	NTN
32015 A	75,000	115,000	25,000	19,000	25,000	0,91	29	SNR
32015X	75,000	115,000	25,000	19,000	25,000	0,90	29	NTN
32016 A	80,000	125,000	29,000	22,000	29,000	1,33	29	SNR
32016X	80,000	125,000	29,000	22,000	29,000	1,28	29	NTN
32017 A	85,000	130,000	29,000	22,000	29,000	1,38	29	SNR
32017X	85,000	130,000	29,000	22,000	29,000	1,33	29	NTN
32018 A	90,000	140,000	32,000	24,000	32,000	1,69	29	SNR
32018X	90,000	140,000	32,000	24,000	32,000	1,79	29	NTN
32019 A	95,000	145,000	32,000	24,000	32,000	1,91	29	SNR
32019X	95,000	145,000	32,000	24,000	32,000	1,84	29	NTN
32020 A	100,000	150,000	32,000	24,000	32,000	1,95	29	SNR
32020X	100,000	150,000	32,000	24,000	32,000	1,91	29	NTN
32021 A	105,000	160,000	35,000	26,000	35,000	2,42	29	SNR
32021X	105,000	160,000	35,000	26,000	35,000	2,42	29	NTN
32022 A	110,000	170,000	38,000	29,000	38,000	3,10	29	SNR
32022X	110,000	170,000	38,000	29,000	38,000	3,07	29	NTN
32024 A	120,000	180,000	38,000	29,000	38,000	3,31	29	SNR
32024X	120,000	180,000	38,000	29,000	38,000	3,40	29	NTN
4T-32024XDF	120,000	180,000	76,000			6,73	30	NTN
32024XUDF	120,000	180,000	76,000			6,80	30	NTN
32026 A	130,000	200,000	45,000	34,000	45,000	5,13	29	SNR
32026X	130,000	200,000	45,000	34,000	45,000	4,96	29	NTN
32026XUDF	130,000	200,000	90,000			10,26	30	NTN
32028 A	140,000	210,000	45,000	34,000	45,000	5,39	29	SNR
32028X	140,000	210,000	45,000	34,000	45,000	5,40	29	NTN
32028XUDF	140,000	210,000	90,000			9,70	30	NTN
32030 A	150,000	225,000	48,000	36,000	48,000	6,46	29	SNR
32030X	150,000	225,000	48,000	36,000	48,000	6,40	29	NTN
32032 A	160,000	240,000	51,000	38,000	51,000	7,87	29	SNR
32032X	160,000	240,000	51,000	38,000	51,000	7,80	29	NTN
32034 A	170,000	260,000	57,000	43,000	57,000	10,60	29	SNR
32034X	170,000	260,000	57,000	43,000	57,000	10,50	29	NTN
32036 A	180,000	280,000	64,000	48,000	64,000	14,20	29	SNR
32036X	180,000	280,000	64,000	48,000	64,000	14,50	29	NTN
32038 A	190,000	290,000	64,000	48,000	64,000	14,57	29	SNR
32038X	190,000	290,000	64,000	48,000	64,000	14,80	29	NTN







Reference	d D		B	C	T	Kg	Brands	
	d	D	B	C	T			
32040 A	200,000	310,000	70,000	53,000	70,000	19,10	29	SNR
32040X	200,000	310,000	70,000	53,000	70,000	17,30	29	NTN
32044X	220,000	340,000	76,000	57,000	76,000	25,00	29	NTN
4T-32044XDF	220,000	340,000	152,000			52,00	30	NTN
32044XUDF	220,000	340,000	152,000			52,00	30	NTN
32048 A	240,000	360,000	76,000	57,000	76,000	26,80	29	SNR
32048X	240,000	360,000	76,000	57,000	76,000	26,80	29	NTN
4T-32048XDF	240,000	360,000	152,000			54,80	30	NTN
32052X	260,000	400,000	87,000	65,000	87,000	39,40	29	NTN
32052XUDF	260,000	400,000	174,000			81,25	30	NTN
32056 A	280,000	420,000	87,000	65,000	87,000	60,00	29	SNR
32056X	280,000	420,000	87,000	65,000	87,000	40,40	29	NTN
32056XUDF	280,000	420,000	174,000			86,80	30	NTN
32060X	300,000	460,000	100,000	74,000	100,000	63,00	29	NTN
32064 A	320,000	480,000	100,000	74,000	100,000	33,50	29	SNR
32064X	320,000	480,000	100,000	74,000	100,000	60,20	29	NTN
32064XUDF	320,000	480,000	200,000			125,00	30	NTN
32068	340,000	520,000	106,000	90,000	112,000	78,70	29	NTN
32072	360,000	540,000	106,000	90,000	112,000	83,70	29	NTN
32076	380,000	560,000	106,000	90,000	112,000	89,10	29	NTN
CRD-3208	160,000	270,000	116,000			27,10	31	NTN
32080	400,000	600,000	118,000	100,000	125,000	115,00	29	NTN
32084	420,000	620,000	118,000	100,000	125,000	121,00	29	NTN
32088	440,000	650,000	122,000	104,000	130,000	136,00	29	NTN
E-CRO-3209	165,100	265,000	173,000			33,60	32	NTN
CRO-3209 (CRO-3210)	160,000	265,000	173,000			37,00	32	NTN
CRI-3210	160,000	270,000	110,000			22,90	30	NTN
EE321145/321240A	368,300	609,600	142,875			162,00	32	NTN
E-EE321146D/321240A+A	368,300	609,600	279,400			313,00	31	NTN
CRI-3219	160,000	270,000	150,000			32,80	30	NTN
322/28R	28,000	58,000	19,000	16,000	20,250	0,24	29	NTN
322/32	32,000	65,000	21,000	18,000	22,250	0,32	29	NTN
32203	17,000	40,000	16,000	14,000	17,250	0,10	29	NTN
32203 A	17,000	40,000	16,000	14,000	17,250	0,11	29	SNR
32204	20,000	47,000	18,000	15,000	19,250	0,16	29	NTN
32205	25,000	52,000	18,000	16,000	19,250	0,19	29	NTN
32205 BA	25,000	52,000	18,000	15,000	19,250	0,19	29	SNR
32205C	25,000	52,000	18,000	15,000	19,250	0,19	29	NTN
32206	30,000	62,000	20,000	17,000	21,250	0,30	29	NTN
32206C	30,000	62,000	20,000	17,000	21,250	0,30	29	NTN
32206 C	30,000	62,000	20,000	17,000	21,250	0,29	29	SNR
32207	35,000	72,000	23,000	19,000	24,250	0,46	29	NTN
32207 B	35,000	72,000	23,000	19,000	24,250	0,46	29	SNR
32207C	35,000	72,000	23,000	19,000	24,250	0,46	29	NTN
32207 C	35,000	72,000	23,000	19,000	24,250	0,45	29	SNR
32208	40,000	80,000	23,000	19,000	24,750	0,56	29	NTN
32208 C	40,000	80,000	23,000	19,000	24,750	0,53	29	SNR
32209	45,000	85,000	23,000	19,000	24,750	0,59	29	NTN
32209 A	45,000	85,000	23,000	19,000	24,750	0,60	29	SNR
32209 BA	45,000	85,000	23,000	19,000	24,750	0,61	29	SNR
32210	50,000	90,000	23,000	19,000	24,750	0,65	29	NTN
32210 A	50,000	90,000	23,000	19,000	24,750	0,65	29	SNR

								Brands
Reference	d	D	B	C	T	Kg		
32211	55,000	100,000	25,000	21,000	26,750	0,86	29	NTN
32211 A	55,000	100,000	25,000	21,000	26,750	0,87	29	SNR
32212	60,000	110,000	28,000	24,000	29,750	1,16	29	NTN
32212 A	60,000	110,000	28,000	24,000	29,750	1,26	29	SNR
32212UDF	60,000	110,000	59,500			2,42	30	NTN
32213	65,000	120,000	31,000	27,000	32,750	1,55	29	NTN
32213 A	65,000	120,000	31,000	27,000	32,750	1,55	29	SNR
32214	70,000	125,000	31,000	27,000	33,250	1,68	29	NTN
32214 A	70,000	125,000	31,000	27,000	33,250	1,74	29	SNR
32215	75,000	130,000	31,000	27,000	33,250	1,72	29	NTN
32215 A	75,000	130,000	31,000	27,000	33,250	1,77	29	SNR
32215UDF	75,000	130,000	66,500			3,55	30	NTN
32216	80,000	140,000	33,000	28,000	35,250	2,16	29	NTN
32216 A	80,000	140,000	33,000	28,000	35,250	2,20	29	SNR
32217	85,000	150,000	36,000	30,000	38,500	2,70	29	NTN
32217 A	85,000	150,000	36,000	30,000	38,500	2,68	29	SNR
4T-32217DF	85,000	150,000	77,000			5,64	30	NTN
32217UDF	85,000	150,000	77,000			5,68	30	NTN
32218	90,000	160,000	40,000	34,000	42,500	3,49	29	NTN
32218 A	90,000	160,000	40,000	34,000	42,500	3,51	29	SNR
32218 C	90,000	160,000	40,000	34,000	42,500	3,29	29	SNR
32218UDF	90,000	160,000	85,000			7,20	30	NTN
32219	95,000	170,000	43,000	37,000	45,500	4,22	29	NTN
32219 A	95,000	170,000	43,000	37,000	45,500	4,30	29	SNR
32219UDF	95,000	170,000	91,000			8,85	30	NTN
32220	100,000	180,000	46,000	39,000	49,000	5,20	29	NTN
32220 A	100,000	180,000	46,000	39,000	49,000	5,14	29	SNR
32220UDF	100,000	180,000	98,000			9,76	30	NTN
32221	105,000	190,000	50,000	43,000	53,000	6,20	29	NTN
32221 A	105,000	190,000	50,000	43,000	53,000	6,27	29	SNR
32222	110,000	200,000	53,000	46,000	56,000	7,43	29	NTN
32222 A	110,000	200,000	53,000	46,000	56,000	7,46	29	SNR
4T-32222DF	110,000	200,000	112,000			13,70	30	NTN
32222UDF	110,000	200,000	112,000			15,40	30	NTN
32224	120,000	215,000	58,000	50,000	61,500	8,98	29	NTN
32224 A	120,000	215,000	58,000	50,000	61,500	9,28	29	SNR
32224UDF	120,000	215,000	123,000			18,30	30	NTN
32226	130,000	230,000	64,000	54,000	67,750	10,70	29	NTN
32226 A	130,000	230,000	64,000	54,000	67,750	11,50	29	SNR
32226UDF	130,000	230,000	135,500			23,00	30	NTN
32228	140,000	250,000	68,000	58,000	71,750	14,10	29	NTN
32228 A	140,000	250,000	68,000	58,000	71,750	14,80	29	SNR
32228UDF	140,000	250,000	143,500			29,00	30	NTN
32230	150,000	270,000	73,000	60,000	77,000	17,80	29	NTN
32230 A	150,000	270,000	73,000	60,000	77,000	18,50	29	SNR
32230UDF	150,000	270,000	154,000			36,92	30	NTN
32232	160,000	290,000	80,000	67,000	84,000	23,60	29	NTN
32232 A	160,000	290,000	80,000	67,000	84,000	22,50	29	SNR
32232UDF	160,000	290,000	168,000			48,30	30	NTN
32234	170,000	310,000	86,000	71,000	91,000	28,70	29	NTN
32234 A	170,000	310,000	86,000	71,000	91,000	29,30	29	SNR
32234UDF	170,000	310,000	182,000			60,50	30	NTN

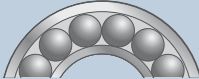



							Brands	
Reference	d	D	B	C	T	Kg		
32236	180,000	320,000	86,000	71,000	91,000	30,10	29	NTN
32236 A	180,000	320,000	86,000	71,000	91,000	30,70	29	SNR
32236UDF	180,000	320,000	182,000			63,50	30	NTN
32238	190,000	340,000	92,000	75,000	97,000	36,08	29	NTN
32240	200,000	360,000	98,000	82,000	104,000	43,60	29	NTN
32244	220,000	400,000	108,000	90,000	114,000	59,20	29	NTN
32244DF	220,000	400,000	228,000			124,30	30	NTN
32248	240,000	440,000	120,000	100,000	127,000	78,80	29	NTN
32248DF	240,000	440,000	254,000			163,00	30	NTN
CR1-3225	160,000	270,000	140,000			31,80	30	NTN
CR1-3225	160,000	270,000	140,000			31,80	30	NTN
32252	260,000	480,000	130,000	106,000	137,000	103,00	29	NTN
32256	280,000	500,000	130,000	106,000	137,000	110,00	29	NTN
32260	300,000	540,000	140,000	115,000	149,000	130,00	29	NTN
32260DF	300,000	540,000	298,000			289,00	30	NTN
32264	320,000	580,000	150,000	125,000	159,000	172,10	29	NTN
323/32	32,000	75,000	28,000	23,000	29,750	0,65	29	NTN
323/32C	32,000	75,000	28,000	23,000	29,750	0,66	29	NTN
323024	120,000	180,000	46,000			4,08	31	NTN
323026	130,000	200,000	52,000			5,92	31	NTN
323028	140,000	210,000	53,000			6,40	31	NTN
323030	150,000	225,000	56,000			7,76	31	NTN
323032	160,000	240,000	60,000			9,46	31	NTN
323034	170,000	260,000	67,000			12,80	31	NTN
323036	180,000	280,000	74,000			16,50	31	NTN
323038	190,000	290,000	75,000			17,90	31	NTN
32304	20,000	52,000	21,000	18,000	22,250	0,24	29	NTN
32304 A	20,000	52,000	21,000	18,000	22,250	0,25	29	SNR
323040	200,000	310,000	82,000			21,70	31	NTN
323040	200,000	310,000	82,000			21,70	31	NTN
323044	220,000	340,000	90,000			29,80	31	NTN
323048	240,000	360,000	92,000			32,60	31	NTN
32305	25,000	62,000	24,000	20,000	25,250	0,38	29	NTN
32305 A	25,000	62,000	24,000	20,000	25,250	0,37	29	SNR
323052	260,000	400,000	104,000			47,30	31	NTN
323056	280,000	420,000	106,000			51,20	31	NTN
32306	30,000	72,000	27,000	23,000	28,750	0,57	29	NTN
32306 A	30,000	72,000	27,000	23,000	28,750	0,58	29	SNR
323060	300,000	460,000	118,000			70,70	31	NTN
323064	320,000	480,000	121,000			76,30	31	NTN
323068	340,000	520,000	133,000			101,00	31	NTN
32306C	30,000	72,000	27,000	23,000	28,750	0,33	29	NTN
32307	35,000	80,000	31,000	25,000	32,750	0,79	29	NTN
32307 A	35,000	80,000	31,000	25,000	32,750	0,80	29	SNR
323072	360,000	540,000	134,000			107,00	31	NTN
323076	380,000	560,000	135,000			113,00	31	NTN
32307 BC12	35,000	80,000	31,000	25,000	32,750	0,80	29	SNR
32307C	35,000	80,000	31,000	25,000	32,750	0,79	29	NTN
32308	40,000	90,000	33,000	27,000	35,250	1,06	29	NTN
32308 A	40,000	90,000	33,000	27,000	35,250	1,04	29	SNR
323080	400,000	600,000	148,000			146,00	31	NTN
323084	420,000	620,000	150,000			154,00	31	NTN







Reference						Kg	?	Brands
	d	D	B	C	T			
323088	440,000	650,000	157,000			177,00	31	NTN
32308 BC12	40,000	90,000	33,000	27,000	35,250	1,04	29	SNR
32308C	40,000	90,000	33,000	27,000	35,250	1,10	29	NTN
32309	45,000	100,000	36,000	30,000	38,250	1,43	29	NTN
32309 A	45,000	100,000	36,000	30,000	38,250	1,49	29	SNR
323092	460,000	680,000	163,000			201,00	31	NTN
323096	480,000	700,000	165,000			211,00	31	NTN
32309 BA	45,000	100,000	36,000	30,000	38,250	1,51	29	SNR
32309C	45,000	100,000	36,000	30,000	38,250	1,45	29	NTN
32310	50,000	110,000	40,000	33,000	42,250	1,90	29	NTN
32310 A	50,000	110,000	40,000	33,000	42,250	1,90	29	SNR
32310C	50,000	110,000	40,000	33,000	42,250	1,95	29	NTN
32311	55,000	120,000	43,000	35,000	45,500	2,41	29	NTN
32311 A	55,000	120,000	43,000	35,000	45,500	2,38	29	SNR
32311 BA	55,000	120,000	43,000	35,000	45,500	2,51	29	SNR
32311C	55,000	120,000	43,000	35,000	45,500	2,46	29	NTN
32312	60,000	130,000	46,000	37,000	48,500	2,98	29	NTN
32312 A	60,000	130,000	46,000	37,000	48,500	2,96	29	SNR
323122	110,000	180,000	56,000			5,60	31	NTN
323124	120,000	200,000	62,000			7,82	31	NTN
323126	130,000	210,000	64,000			8,58	31	NTN
323128	140,000	225,000	68,000			10,70	31	NTN
32312C	60,000	130,000	46,000	37,000	48,500	2,99	29	NTN
32313	65,000	140,000	48,000	39,000	51,000	3,66	29	NTN
32313 A	65,000	140,000	48,000	39,000	51,000	3,64	29	SNR
323130	150,000	250,000	80,000			15,70	31	NTN
323132	160,000	270,000	86,000			20,00	31	NTN
323134	170,000	280,000	88,000			21,50	31	NTN
323134	170,000	280,000	88,000			21,40	31	NTN
323136	180,000	300,000	96,000			27,20	31	NTN
323138	190,000	320,000	104,000			34,00	31	NTN
32313 BA	65,000	140,000	48,000	39,000	51,000	3,76	29	SNR
32314	70,000	150,000	51,000	42,000	54,000	4,46	29	NTN
32314 A	70,000	150,000	51,000	42,000	54,000	4,31	29	SNR
323140	200,000	340,000	112,000			41,70	31	NTN
323144	220,000	370,000	120,000			51,20	31	NTN
323148	240,000	400,000	128,000			64,60	31	NTN
32314 BA	70,000	150,000	51,000	42,000	54,000	4,42	29	SNR
32314C	70,000	150,000	51,000	42,000	54,000	4,18	29	NTN
32315	75,000	160,000	55,000	45,000	58,000	5,40	29	NTN
32315 A	75,000	160,000	55,000	45,000	58,000	5,37	29	SNR
323152	260,000	440,000	144,000			90,00	31	NTN
323156	280,000	460,000	146,000			95,80	31	NTN
32315 BC	75,000	160,000	55,000	45,000	58,000	5,20	29	SNR
32315C	75,000	160,000	55,000	45,000	58,000	5,65	29	NTN
32316	80,000	170,000	58,000	48,000	61,500	6,09	29	NTN
323160	300,000	500,000	160,000			126,00	31	NTN
323164	320,000	540,000	176,000			164,00	31	NTN
323168	340,000	580,000	190,000			207,00	31	NTN
32316 BC12	80,000	170,000	58,000	48,000	61,500	6,30	29	SNR
32316C	80,000	170,000	58,000	48,000	61,500	6,50	29	NTN
32317	85,000	180,000	60,000	49,000	63,500	7,15	29	NTN

								Brands
Reference	d	D	B	C	T	Kg		
32317 A	85,000	180,000	60,000	49,000	63,500	7,45	29	SNR
323172	360,000	600,000	192,000			218,00	31	NTN
323176	380,000	620,000	194,000			229,00	31	NTN
32317 BC12	85,000	180,000	60,000	46,000	63,500	7,13	29	SNR
32318	90,000	190,000	64,000	53,000	67,500	8,60	29	NTN
32318 A	90,000	190,000	64,000	53,000	67,500	8,88	29	SNR
323180	400,000	650,000	200,000			259,00	31	NTN
323184	420,000	700,000	224,000			346,00	31	NTN
323188	440,000	720,000	226,000			361,00	31	NTN
32319	95,000	200,000	67,000	55,000	71,500	10,10	29	NTN
323192	460,000	760,000	240,000			431,00	31	NTN
323196	480,000	790,000	248,000			478,00	31	NTN
32320	100,000	215,000	73,000	60,000	77,500	12,80	29	NTN
32320 B	100,000	215,000	73,000	55,000	77,500	12,20	29	SNR
32321	105,000	225,000	77,000	63,000	81,500	14,50	29	NTN
32322	110,000	240,000	80,000	65,000	84,500	18,00	29	NTN
32322DF	110,000	240,000	169,000			37,00	30	NTN
32324	120,000	260,000	86,000	69,000	90,500	22,40	29	NTN
32326	130,000	280,000	93,000	78,000	98,750	27,20	29	NTN
32328	140,000	300,000	102,000	85,000	107,750	32,90	29	NTN
32330	150,000	320,000	108,000	90,000	114,000	42,00	29	NTN
32332	160,000	340,000	114,000	95,000	121,000	48,50	29	NTN
32332DF	160,000	340,000	242,000			101,00	30	NTN
32334	170,000	360,000	120,000	100,000	127,000	56,50	29	NTN
32336	180,000	380,000	126,000	106,000	134,000	66,80	29	NTN
32338	190,000	400,000	132,000	109,000	140,000	76,90	29	NTN
32340	200,000	420,000	138,000	115,000	146,000	86,00	29	NTN
32340DF	200,000	420,000	292,000			187,50	30	NTN
32344	220,000	460,000	145,000	122,000	154,000	112,80	29	NTN
32348	240,000	500,000	155,000	132,000	165,000	130,02	29	NTN
32356	280,000	580,000	175,000	145,000	187,000	222,00	29	NTN
CRD-3253	160,000	260,000	130,000			26,50	31	NTN
CRD-3254	160,000	240,000	110,000			17,30	31	NTN
CRI-3256	160,000	240,000	110,000			15,60	30	NTN
CRI-3258	160,000	280,000	150,000			34,80	30	NTN
CR1-3266	160,000	290,000	200,000			56,90	30	NTN
4T-L327249	133,350		26,195			1,15	29	NTN
4T-L327249/L327210	133,350	177,008	26,195	20,638	25,400	1,70	29	NTN
32907X	35,000	55,000	14,000	11,500	14,000	0,12	29	NTN
32908X	40,000	62,000	15,000	12,000	15,000	0,16	29	NTN
32909X	45,000	68,000	15,000	12,000	15,000	0,18	29	NTN
EE329119D/329172/329173D	304,648	438,048	279,400			143,00	32	NTN
E-EE329119D/329172/329173D	304,648	438,048	279,400			143,00	32	NTN
EE329119D/329172+A	304,648	438,048	131,762			64,30	31	NTN
32911X	55,000	80,000	17,000	14,000	17,000	0,27	29	NTN
32912X	60,000	85,000	17,000	14,000	17,000	0,29	29	NTN
32913X	65,000	90,000	17,000	14,000	17,000	0,31	29	NTN
32914X	70,000	100,000	20,000	16,000	20,000	0,48	29	NTN
32915DF	75,000	105,000	40,000			0,99	30	NTN
32915X	75,000	105,000	20,000	16,000	20,000	0,51	29	NTN
32916X	80,000	110,000	20,000	16,000	20,000	0,54	29	NTN
32917X	85,000	120,000	23,000	18,000	23,000	0,77	29	NTN







Reference						Kg	?	Brands
	d	D	B	C	T			
32918X	90,000	125,000	23,000	18,000	23,000	0,80	29	NTN
32919X	95,000	130,000	23,000	18,000	23,000	0,85	29	NTN
32920X	100,000	140,000	25,000	20,000	25,000	1,14	29	NTN
32921X	105,000	145,000	25,000	20,000	25,000	1,19	29	NTN
32922X	110,000	150,000	25,000	20,000	25,000	1,24	29	NTN
32924X	120,000	165,000	29,000	23,000	29,000	1,77	29	NTN
32926DF	130,000	180,000	64,000			4,90	30	NTN
32926X	130,000	180,000	32,000	25,000	32,000	2,36	29	NTN
32928X	140,000	190,000	35,000	25,000	32,000	2,50	29	NTN
32930X	150,000	210,000	38,000	30,000	38,000	3,92	29	NTN
32930XUDF	150,000	210,000	76,000			8,02	30	NTN
32932X	160,000	220,000	38,000	30,000	38,000	4,14	29	NTN
32934X	170,000	230,000	38,000	30,000	38,000	4,40	29	NTN
32936X	180,000	250,000	45,000	34,000	45,000	6,48	29	NTN
32938X	190,000	260,000	45,000	34,000	45,000	6,77	29	NTN
32940	200,000	280,000	51,000	39,000	51,000	9,57	29	SNR
32940X	200,000	280,000	51,000	39,000	51,000	9,14	29	NTN
32944X	220,000	300,000	51,000	39,000	51,000	10,20	29	NTN
32948X	240,000	320,000	51,000	39,000	51,000	10,90	29	NTN
32952X	260,000	360,000	63,500	48,000	63,500	18,60	29	NTN
32956X	280,000	380,000	63,500	48,000	63,500	20,00	29	NTN
32960X	300,000	420,000	76,000	57,000	76,000	31,40	29	NTN
32964X	320,000	440,000	76,000	57,000	76,000	33,10	29	NTN
32968X	340,000	460,000	76,000	57,000	76,000	34,90	29	NTN
32972X	360,000	480,000	76,000	57,000	76,000	36,60	29	NTN
32976	380,000	520,000	82,000	72,000	87,000	50,50	29	NTN
32980	400,000	540,000	82,000	71,000	87,000	54,00	29	NTN
32984	420,000	560,000	82,000	71,000	87,000	56,60	29	NTN
32988	440,000	600,000	95,000	82,000	100,000	76,00	29	NTN
33005	25,000	47,000	17,000	14,000	17,000	0,13	29	NTN
33006	30,000	55,000	20,000	16,000	20,000	0,20	29	NTN
33007	35,000	62,000	21,000	17,000	21,000	0,26	29	NTN
33008	40,000	68,000	22,000	18,000	22,000	0,31	29	NTN
33009	45,000	75,000	24,000	19,000	24,000	0,40	29	NTN
33010	50,000	80,000	24,000	19,000	24,000	0,44	29	NTN
33011	55,000	90,000	27,000	21,000	27,000	0,64	29	NTN
33011 A	55,000	90,000	27,000	21,000	27,000	0,71	29	SNR
33011 VC12	55,000	90,000	27,000	21,000	27,000	0,67	29	SNR
33012	60,000	95,000	27,000	21,000	27,000	0,69	29	NTN
33012 A	60,000	95,000	27,000	21,000	27,000	0,70	29	SNR
33013	65,000	100,000	27,000	21,000	27,000	0,73	29	NTN
33013 A	65,000	100,000	27,000	21,000	27,000	0,78	29	SNR
33014	70,000	110,000	31,000	25,500	31,000	1,07	29	NTN
33014 A	70,000	110,000	31,000	25,500	31,000	1,11	29	SNR
33015	75,000	115,000	31,000	25,500	31,000	1,11	29	NTN
33015 A	75,000	115,000	31,000	25,500	31,000	1,18	29	SNR
33015UDF	75,000	115,000	62,000			2,27	30	NTN
33015 VC12	75,000	115,000	31,000	25,500	31,000	1,15	29	SNR
33016	80,000	125,000	36,000	29,500	36,000	1,60	29	NTN
33016 A	80,000	125,000	36,000	29,500	36,000	1,68	29	SNR
33016 VC12	80,000	125,000	36,000	29,500	36,000	1,61	29	SNR
33017	85,000	130,000	36,000	29,500	36,000	1,70	29	NTN





Reference	d		D		B	C	T	Kg	Brands
	d	D	B	C	T				
33017 A	85,000	130,000	36,000	29,500	36,000	1,73	29	SNR	
33017 VC12	85,000	130,000	36,000	29,500	36,000	1,73	29	SNR	
33018	90,000	140,000	39,000	32,500	39,000	2,19	29	NTN	
33018 A	90,000	140,000	39,000	32,500	39,000	2,20	29	SNR	
33019	95,000	145,000	45,000	38,000	39,000	2,27	29	NTN	
33019 A	95,000	145,000	39,000	32,500	39,000	2,34	29	SNR	
33020	100,000	150,000	39,000	32,500	39,000	2,14	29	NTN	
33020 A	100,000	150,000	39,000	32,500	39,000	2,42	29	SNR	
33020 VC12	100,000	150,000	39,000	32,500	39,000	2,39	29	SNR	
33021	105,000	160,000	43,000	34,000	43,000	3,00	29	NTN	
33021 A	105,000	160,000	43,000	34,000	43,000	3,14	29	SNR	
33021 VC12	105,000	160,000	43,000	34,000	43,000	3,16	29	SNR	
33022	110,000	170,000	47,000	37,000	47,000	3,47	29	NTN	
33022 A	110,000	170,000	47,000	37,000	47,000	3,90	29	SNR	
33024	120,000	180,000	48,000	38,000	48,000	4,10	29	NTN	
33024 A	120,000	180,000	48,000	38,000	48,000	4,28	29	SNR	
33024 VC12	120,000	180,000	48,000	38,000	48,000	4,32	29	SNR	
33028	140,000	210,000	56,000	44,000	56,000	6,03	29	NTN	
33030	150,000	225,000	59,000	46,000	59,000	8,07	29	NTN	
CRI-3305	165,000	350,000	146,000			61,20	30	NTN	
CRI-3309	165,000	290,000	150,000			37,50	30	NTN	
33108	40,000	75,000	26,000	20,500	26,000	0,49	29	NTN	
33108 A	40,000	75,000	26,000	20,500	26,000	0,52	29	SNR	
33109	45,000	80,000	26,000	20,500	26,000	0,54	29	NTN	
33109 A	45,000	80,000	26,000	20,500	26,000	0,55	29	SNR	
33110	50,000	85,000	26,000	20,000	26,000	0,58	29	NTN	
33110 A	50,000	85,000	26,000	20,000	26,000	0,61	29	SNR	
33111	55,000	95,000	30,000	23,000	30,000	0,85	29	NTN	
33111 A	55,000	95,000	30,000	23,000	30,000	0,83	29	SNR	
33112	60,000	100,000	30,000	23,000	30,000	0,91	29	NTN	
33112 A	60,000	100,000	30,000	23,000	30,000	0,92	29	SNR	
33113	65,000	110,000	34,000	26,500	34,000	1,28	29	NTN	
33113 A	65,000	110,000	34,000	26,500	34,000	1,33	29	SNR	
33114	70,000	120,000	37,000	29,000	37,000	1,66	29	NTN	
33115	75,000	125,000	37,000	29,000	37,000	1,73	29	NTN	
33115 A	75,000	125,000	37,000	29,000	37,000	1,81	29	SNR	
33116	80,000	130,000	37,000	29,000	37,000	1,84	29	NTN	
33116 A	80,000	130,000	37,000	29,000	37,000	1,91	29	SNR	
33117	85,000	140,000	41,000	32,000	41,000	2,40	29	NTN	
33117 A	85,000	140,000	41,000	32,000	41,000	2,49	29	SNR	
33118	90,000	150,000	45,000	35,000	45,000	3,20	29	NTN	
33118 A	90,000	150,000	45,000	35,000	45,000	3,15	29	SNR	
33122	110,000	180,000	56,000	43,000	56,000	5,52	29	NTN	
4T-332		80,000		17,826		0,14	29	NTN	
332/28	28,000	58,000	24,000	19,000	24,000	0,29	29	NTN	
332/32	32,000	65,000	26,000	20,500	26,000	0,40	29	NTN	
4T-3320		80,167		23,812		0,21	29	NTN	
33205	25,000	52,000	22,000	18,000	22,000	0,22	29	NTN	
33205 A	25,000	52,000	22,000	18,000	22,000	0,23	29	SNR	
33206	30,000	62,000	25,000	19,500	25,000	0,34	29	NTN	
33206 A	30,000	62,000	25,000	19,500	25,000	0,36	29	SNR	
33207	35,000	72,000	28,000	22,000	28,000	0,53	29	NTN	





Reference						Kg	?	Brands
	d	D	B	C	T			
33207 A	35,000	72,000	28,000	22,000	28,000	0,55	29	SNR
33208	40,000	80,000	32,000	25,000	32,000	0,73	29	NTN
33208 A	40,000	80,000	32,000	25,000	32,000	0,76	29	SNR
33209	45,000	85,000	32,000	25,000	32,000	0,79	29	NTN
33209 A	45,000	85,000	32,000	25,000	32,000	0,80	29	SNR
33210	50,000	90,000	32,000	24,500	32,000	0,85	29	NTN
33210 A	50,000	90,000	32,000	24,500	32,000	0,89	29	SNR
33211	55,000	100,000	35,000	27,000	35,000	1,15	29	NTN
33211 A	55,000	100,000	35,000	27,000	35,000	1,21	29	SNR
33212	60,000	110,000	38,000	29,000	38,000	1,51	29	NTN
33212 A	60,000	110,000	38,000	29,000	38,000	1,57	29	SNR
33213	65,000	120,000	41,000	32,000	41,000	1,98	29	NTN
33213 A	65,000	120,000	41,000	32,000	41,000	2,03	29	SNR
33214	70,000	125,000	41,000	32,000	41,000	2,08	29	NTN
33214 A	70,000	125,000	41,000	32,000	41,000	2,17	29	SNR
33215	75,000	130,000	41,000	31,000	41,000	2,20	29	NTN
33215 A	75,000	130,000	41,000	31,000	41,000	2,27	29	SNR
33216	80,000	140,000	46,000	35,000	46,000	2,92	29	NTN
33216 A	80,000	140,000	46,000	35,000	46,000	2,95	29	SNR
33217	85,000	150,000	49,000	37,000	49,000	3,58	29	NTN
33217 A	85,000	150,000	49,000	37,000	49,000	3,68	29	SNR
33218	90,000	160,000	55,000	42,000	55,000	4,62	29	NTN
33220	100,000	180,000	63,000	48,000	63,000	6,82	29	NTN
33221	105,000	190,000	68,000	52,000	68,000	8,35	29	NTN
4T-33225	57,150		30,162			1,14	29	NTN
4T-33225/33462	57,150	117,475	30,162	23,812	30,162	1,58	29	NTN
4T-33262	66,675		30,162			0,91	29	NTN
4T-33262/33462	66,675	117,475	30,162	23,812	30,162	1,33	29	NTN
4T-33275	69,850		30,162			0,83	29	NTN
4T-33275/33462	69,850	117,475	30,162	23,812	30,162	1,26	29	NTN
4T-33275/33472	69,850	120,000	30,162	23,444	30,162	1,35	29	NTN
4T-33281	71,438		30,162			0,78	29	NTN
4T-33281/33462	71,438	117,475	30,162	23,812	30,162	1,21	29	NTN
4T-33281/33472	71,438	120,000	30,162	23,444	30,162	1,30	29	NTN
4T-33287	73,025		30,162			0,74	29	NTN
4T-33287/33462	73,025	117,475	30,162	23,812	30,162	1,18	29	NTN
4T-33287/33472	73,025	120,000	30,162	23,444	30,162	1,26	29	NTN
4T-332A		80,000		21,000		0,18	29	NTN
E-EE333137	349,250		84,138			37,20	29	NTN
EE333137/333197	349,250	501,650	84,138	69,850	90,488	56,40	29	NTN
EE333137/333203D+A	349,250	514,350	193,675			121,00	30	NTN
E-EE333140	355,600		84,138			34,90	29	NTN
EE333140/333197	355,600	501,650	84,138	69,850	90,488	50,80	29	NTN
EE333140/333203D+A	355,600	514,350	193,675			117,00	30	NTN
4T-33462		117,475		23,812		0,43	29	NTN
4T-33472		120,000		23,444		0,52	29	NTN
4T-336	41,275		22,403			0,33	29	NTN
4T-336/332	41,275	80,000	22,403	17,826	22,403	0,47	29	NTN
4T-3379	34,925		30,391			0,52	29	NTN
4T-3379/3320	34,925	80,167	30,391	23,812	30,391	0,73	29	NTN
4T-3381	38,100		30,391			0,47	29	NTN
4T-3381/3320	38,100	80,167	30,391	23,812	30,391	0,68	29	NTN





Reference	d		D		B	C	T	Kg	Brands	
4T-3382	39,688				30,391			0,45	29	NTN
4T-3382/3320	39,688	80,167			30,391	23,812	30,391	0,66	29	NTN
4T-3382/3321	39,688	77,534			30,391	23,812	29,370	0,67	29	NTN
4T-3382/3339	39,688	80,035			30,391	23,812	29,370	0,67	29	NTN
4T-33820B		93,264				22,225		0,24	29	NTN
4T-33821		95,250				22,225		0,26	29	NTN
4T-33822		95,250				22,225		0,27	29	NTN
4T-3383	41,288				30,467			0,42	29	NTN
4T-3384	41,275				30,391			0,43	29	NTN
4T-3384/3320	41,275	80,167			30,391	23,812	30,391	0,64	29	NTN
4T-3386	39,688				30,391			0,45	29	NTN
4T-3386/3320	39,688	80,167			30,391	23,812	30,391	0,66	29	NTN
4T-3386/3325	39,688	79,975			30,391	23,812	29,370	0,67	29	NTN
4T-33880	38,100				28,575			0,80	29	NTN
4T-33885	44,463				28,575			0,72	29	NTN
4T-33885/33821	44,450	95,250			28,575	22,225	27,783	0,99	29	NTN
4T-33885/33822	44,450	95,250			28,575	22,225	28,575	0,98	29	NTN
4T-33889	50,800				28,575			0,60	29	NTN
4T-33889/33821	50,800	95,250			28,575	22,225	28,575	0,86	29	NTN
4T-33889/33822	50,800	95,250			28,575	22,225	28,575	0,87	29	NTN
4T-33890	52,388				28,575			0,58	29	NTN
4T-33890/33821	52,388	95,250			28,575	22,225	27,783	0,85	29	NTN
4T-33891	52,388				28,575			0,58	29	NTN
4T-33891/33821	52,388	95,250			28,575	22,225	28,575	0,58	29	NTN
4T-33895	53,975				28,575			0,55	29	NTN
4T-33895/33821	53,975	95,250			28,575	22,225	28,575	0,81	29	NTN
4T-33895/33822	53,975	95,250			28,575	22,225	28,575	0,82	29	NTN
4T-339	35,000				22,403			0,39	29	NTN
4T-339/332	35,000	80,000			22,403	17,826	22,403	0,53	29	NTN
CRTD3401	170,000	240,000			84,000			12,00	38	NTN
CRO-3409	170,000	280,000			181,000			44,00	32	NTN
E-CRO-3409	170,000	280,000			181,000			44,00	32	NTN
CRI-3410	170,000	280,000			150,000			32,70	30	NTN
CRI-3410	170,000	280,000			150,000			34,30	30	NTN
CRD-3413	170,000	280,000			76,000			18,50	31	NTN
CRD-3414	170,000	360,000			144,000			79,70	31	NTN
CRD-3416	170,000	360,000			160,000			71,90	31	NTN
CR-3418	170,000	260,000			67,000	43,000	67,000	11,48	29	NTN
4T-342	41,275				22,403			0,31	29	NTN
4T-3420		79,375				23,812		0,25	29	NTN
CRI-3420	170,000	250,000			85,000			12,60	30	NTN
CRI-3420	170,000	250,000			85,000			12,60	30	NTN
CRD-3423	170,000	300,000			100,000			30,20	31	NTN
4T-34274	69,952				23,012			0,78	29	NTN
4T-34274/34478	69,952	121,442			23,012	17,462	24,608	1,11	29	NTN
4T-342A	41,275				29,977			0,40	29	NTN
4T-342S	42,875				22,403			0,31	29	NTN
4T-342S/332	42,875	80,000			22,403	17,826	22,403	0,45	29	NTN
4T-34300	76,200				23,012			0,66	29	NTN
4T-34300/34478	76,200	121,442			23,012	17,462	24,608	0,98	29	NTN
4T-34301	76,200				23,012			0,65	29	NTN
4T-34301/34478	76,200	121,442			23,012	17,462	24,608	0,98	29	NTN

Reference						Kg	?	Brands
	d	D	B	C	T			
4T-34301/34500	76,200	127,000	23,012	19,842	26,998	1,19	29	NTN
4T-34306	77,788		23,012			0,62	29	NTN
4T-34306/34478	77,788	121,442	23,012	17,462	24,608	0,94	29	NTN
4T-34306/34500	77,788	127,000	23,012	19,842	26,988	1,15	29	NTN
4T-344/332	40,000	80,000	22,403	17,826	22,403	0,48	29	NTN
4T-34478		121,442		17,462		0,31	29	NTN
4T-34492A	77,788		16,400			0,38	29	NTN
4T-344A	40,000		22,403			0,34	29	NTN
4T-344A/332	40,000	80,000	22,403	17,826	22,403	0,48	29	NTN
4T-34500		127,000		19,842		0,53	29	NTN
CRI-3452	170,000	280,000	134,000			32,80	30	NTN
CR-3463	170,000	360,000	75,000	46,000	83,000	34,20	29	NTN
4T-3476	31,750		29,771			0,47	29	NTN
4T-3476/3420	31,750	79,375	29,771	23,812	29,370	0,77	29	NTN
4T-3478	34,925		29,771			0,47	29	NTN
4T-3478/3420	34,925	79,375	29,771	23,812	29,771	0,72	29	NTN
4T-3479	36,512		29,771			0,45	29	NTN
4T-3479/3420	36,512	79,375	29,771	23,812	29,370	0,71	29	NTN
4T-3482	34,925		29,771			0,47	29	NTN
4T-M348449/M348410	247,650	346,075	63,700	50,800	63,500	17,70	29	NTN
T-M348449/M348410	247,650	346,075	63,500	50,800	63,500	16,20	29	NTN
4T-3490	38,100		29,771			0,42	29	NTN
4T-3490/3420	38,100	79,375	29,771	23,812	29,370	0,68	29	NTN
M349549/M349510	257,175	342,900	57,150	44,450	57,150	12,90	29	NTN
M349549A/M349510	257,175	342,900	57,150	44,450	57,150	12,90	29	NTN
CRD-3502	177,000	248,000	90,488			13,45	31	NTN
CRT3503	174,625	358,775	82,550			43,40	37	NTN
E-CRT3503	174,625	358,775	82,550			43,40	37	NTN
EE350701/351687	177,800	428,625	95,250	61,912	106,362	77,70	29	NTN
EE350750/351687	190,500	428,625	95,250	61,912	106,362	75,30	29	NTN
4T-350A/354A	40,000	85,000	21,692	17,462	20,638	0,56	29	NTN
4T-352		90,119		21,808		0,32	29	NTN
4T-3520		84,138		23,812		0,22	29	NTN
4T-3525		87,312		23,812		0,30	29	NTN
4T-3526X		87,338		23,813		0,31	29	NTN
4T-354A		85,027		17,462		0,16	29	NTN
4T-354X		85,000		17,462		0,16	29	NTN
4T-355	44,450		21,692			0,35	29	NTN
4T-355/354A	44,450	85,000	21,692	17,462	20,638	0,51	29	NTN
4T-355A	44,463		21,692			0,34	29	NTN
4T-355X	44,450		21,692			0,34	29	NTN
4T-355X/352	44,450	90,119	21,692	21,808	23,000	0,66	29	NTN
4T-355X/354X	44,450	85,000	21,692	17,462	20,638	0,50	29	NTN
4T-357	40,000		21,692			0,40	29	NTN
4T-357/354A	40,000	85,000	21,692	17,462	21,692	0,56	29	NTN
L357049/L357010	304,800	393,700	50,800	38,100	50,800	13,80	29	NTN
L357049/L357010D+A	304,800	393,700	107,950			29,30	30	NTN
4T-3576/3525	41,275	87,312	30,886	23,812	30,162	0,83	29	NTN
4T-3577	41,275		30,886			0,52	29	NTN
4T-3577/3525	41,275	87,312	30,886	23,812	30,886	0,82	29	NTN
4T-3578	44,450		30,886			0,47	29	NTN
4T-3578/3520	44,450	84,138	30,886	23,812	30,162	0,70	29	NTN





Reference	d		D		B	C	T	Kg	Brands
	d	D	B	C	T				
4T-3578/3525	44,450	87,312	30,886	23,812	30,886	0,76	29	NTN	
4T-3578A	44,450		30,886			0,47	29	NTN	
4T-3579	42,862		30,886			0,50	29	NTN	
4T-3579/3525	42,862	87,312	30,886	23,812	30,162	0,81	29	NTN	
4T-358/354A	45,000	85,000	21,692	17,462	20,638	0,51	29	NTN	
4T-3580/3525	38,100	87,312	30,886	23,812	30,162	0,88	29	NTN	
4T-3583	38,100		30,886			0,57	29	NTN	
4T-3585	41,275		30,886			0,53	29	NTN	
4T-3585/3525	41,275	87,312	30,886	23,812	30,886	0,83	29	NTN	
4T-3586	45,237		30,886			0,46	29	NTN	
4T-3586/3525	45,237	87,312	30,886	23,812	30,162	0,77	29	NTN	
4T-358X	45,000		21,692			0,34	29	NTN	
4T-358X/354A	45,000	85,000	21,692	17,462	21,692	0,50	29	NTN	
4T-359A	46,038		21,692			0,31	29	NTN	
4T-359A/354A	46,038	85,000	21,692	17,462	20,638	0,49	29	NTN	
4T-359S	46,038		21,692			0,33	29	NTN	
4T-359S/352	46,038	90,119	21,692	21,808	23,000	0,65	29	NTN	
4T-359S/354A	46,038	85,000	21,692	17,462	21,692	0,49	29	NTN	
4T-359S/354X	46,038	85,000	21,692	17,462	21,692	0,49	29	NTN	
E-CRT3614	177,800	368,300	82,550			48,30	37	NTN	
CRD-3615	180,000	330,000	190,000			71,60	31	NTN	
LM361649/LM361610	342,900	450,850	66,675	52,388	66,675	25,00	29	NTN	
CRO-3617	180,000	300,000	280,000			69,40	32	NTN	
E-CRO-3617	180,000	300,000	280,000			69,40	32	NTN	
E-CRT3617	177,800	368,300	82,550			45,30	37	NTN	
CR1-3618	180,000	340,000	180,000			67,70	30	NTN	
CRI-3618	180,000	340,000	180,000			68,50	30	NTN	
4T-CR1-3618C3	180,000	340,000	180,000			68,30	30	NTN	
4T-362		90,000		15,875		0,17	29	NTN	
CRD-3622	180,000	400,000	232,000			146,50	31	NTN	
CRD-3623	180,000	380,000	158,000			78,70	31	NTN	
CRI-3623	180,000	280,000	134,500			27,00	30	NTN	
CRI-3625	180,000	300,000	164,000			43,70	30	NTN	
4T-362A		88,925		16,513		0,16	29	NTN	
4T-363		90,000		20,000		0,24	29	NTN	
4T-365	50,000		22,225			0,36	29	NTN	
4T-365/362	50,000	90,000	22,225	15,875	22,225	0,54	29	NTN	
4T-365/362A	50,000	88,900	22,225	16,513	20,638	0,53	29	NTN	
LL365340/LL365310D+A	384,175	441,325	68,262			14,10	30	NTN	
E-LL365348/LL365310	384,175	441,325	28,575	20,638	28,575	6,03	29	NTN	
LL365348/LL365310	384,175	441,325	28,575	20,638	28,575	5,89	29	NTN	
CRO-3658	180,000	250,000	185,000			27,50	32	NTN	
4T-3659	23,812		30,416			0,30	29	NTN	
4T-366	50,000		22,225			0,36	29	NTN	
4T-366/362A	50,000	88,900	22,225	16,513	20,638	0,53	29	NTN	
CRO-3663	177,800	304,800	238,227			67,30	32	NTN	
CRO-3666	180,000	260,000	185,000			32,30	32	NTN	
4T-36686/36620D	142,875	193,675	65,085			5,12	30	NTN	
4T-36690	146,050		28,575			3,10	29	NTN	
4T-36690/36620	146,050	193,675	28,575	23,020	28,575	2,25	29	NTN	
4T-367	45,000		22,225			0,36	29	NTN	
4T-367/362A	45,000	88,900	22,225	16,513	20,638	0,60	29	NTN	

Reference						Kg	?	Brands
	d	D	B	C	T			
4T-368	50,800		22,225			0,35	29	NTN
4T-368/362	50,800	90,000	22,225	15,875	22,225	0,52	29	NTN
4T-368/362A	50,800	88,900	22,225	16,513	20,638	0,52	29	NTN
4T-368A	50,800		22,225			0,35	29	NTN
4T-368A/362	50,800	90,000	22,225	15,875	20,000	0,52	29	NTN
4T-368A/362A	50,800	88,900	22,225	16,513	22,225	0,51	29	NTN
4T-368A/363	50,800	90,000	22,225	20,000	22,225	0,55	29	NTN
4T-368S	51,592		22,225			0,34	29	NTN
4T-368S/362	51,592	90,000	22,225	15,875	22,225	0,52	29	NTN
4T-368S/362A	51,592	88,900	22,225	16,513	20,638	0,51	29	NTN
4T-36920		227,012		23,020		0,90	29	NTN
4T-36990	177,800		30,162			2,00	29	NTN
4T-36990/36920	177,800	227,012	30,162	23,020	30,162	2,92	29	NTN
4T-36990/36920CD+A	177,800	227,012	66,672			6,30	30	NTN
4T-369A	47,625		22,225			0,39	29	NTN
4T-369A/362A	47,625	88,900	22,225	16,513	20,638	0,56	29	NTN
4T-369S	47,625		22,225			0,40	29	NTN
4T-369S/362A	47,625	88,900	22,225	16,513	22,225	0,56	29	NTN
4T-370A	50,800		22,225			0,34	29	NTN
4T-370A/362A	50,800	88,900	22,225	16,513	20,638	0,51	29	NTN
4T-3720		93,264		23,812		0,29	29	NTN
4T-3726		95,250		23,812		0,35	29	NTN
4T-3730		93,264		23,812		0,30	29	NTN
4T-3732		98,425		23,812		0,43	29	NTN
4T-37425	107,950		21,438			0,88	29	NTN
4T-37425/37625	107,950	158,750	21,438	15,875	23,020	1,37	29	NTN
4T-37431	109,538		21,438			0,84	29	NTN
4T-37431/37625	109,538	158,750	21,438	15,875	23,020	1,31	29	NTN
4T-37431A	109,538		21,438			1,25	29	NTN
4T-37431A/37625	109,538	158,750	21,438	15,875	23,020	1,30	29	NTN
4T-37625		158,775		15,875		0,49	29	NTN
4T-3767	52,388		30,302			0,52	29	NTN
4T-3767/3720	52,388	93,264	30,302	23,812	30,162	0,82	29	NTN
4T-3774	39,688		30,302			0,56	29	NTN
LM377449/LM377410	558,800	736,600	104,775	80,962	104,775	106,00	29	NTN
LM377449/LM377410D+A	558,800	736,600	225,425			227,00	30	NTN
E-LM377449D/LM377410/LM377410DG2	558,800	736,600	409,575			502,00	32	NTN
LM377449D/LM377410/LM377410DG2 (CRO-11216)	558,800	736,600	409,575			502,00	32	NTN
E-LM377449D/LM377410+A	558,800	736,600	196,850			224,00	31	NTN
LM377449D/LM377410G2+A	558,800	736,600	196,850			223,00	31	NTN
4T-3775	50,800		30,302			0,55	29	NTN
4T-3775/3720	50,800	93,264	30,302	23,812	30,162	0,85	29	NTN
4T-3776	44,983		30,302			0,65	29	NTN
4T-3776/3720	44,983	93,264	30,302	23,812	30,302	0,94	29	NTN
4T-3777/3720	46,038	93,264	30,302	23,812	30,162	0,93	29	NTN
4T-3778	47,625		30,302			0,60	29	NTN
4T-3778/3720	47,625	93,264	30,302	23,812	30,162	0,90	29	NTN
4T-3779	47,625		30,302			0,61	29	NTN
4T-3779/3720	47,625	93,264	30,302	23,812	30,302	0,89	29	NTN
4T-3780	50,800		30,302			0,55	29	NTN
4T-3780/3720	50,800	93,264	30,302	23,812	30,162	0,85	29	NTN
4T-3780/3726	50,800	95,250	30,302	23,812	30,162	0,90	29	NTN





Reference						Kg	?	Brands
	d	D	B	C	T			
4T-3780/3732	50,800	98,425	30,302	23,812	30,162	0,99	29	NTN
4T-3781	49,212		30,302			0,58	29	NTN
4T-3781/3720	49,212	93,264	30,302	23,812	30,162	0,88	29	NTN
4T-3782	44,450		30,302			0,66	29	NTN
4T-3782/3720	44,450	93,264	30,302	23,812	30,302	0,95	29	NTN
4T-3784	50,800		30,302			0,54	29	NTN
4T-3784/3720	50,800	93,264	30,302	23,812	30,302	0,83	29	NTN
4T-3795	50,800		30,302			0,55	29	NTN
T-EE380080/380190G2	203,200	482,600	95,250	73,025	117,475	108,00	29	NTN
T-EE380081/380190G2	206,375	482,600	95,250	73,025	117,475	107,00	29	NTN
CRD-3801	190,000	320,000	104,000			34,10	31	NTN
CRD-3811	190,000	350,000	135,000			57,70	31	NTN
CRO-3812	190,000	270,000	190,000			34,70	32	NTN
E-CRO-3812	190,000	270,000	190,000			34,70	32	NTN
CRD-3813	190,000	320,000	104,000			34,10	31	NTN
CRO-3813	190,000	270,000	190,000			34,50	32	NTN
4T-382		98,425		17,826		0,22	29	NTN
4T-3820		85,750		23,812		0,28	29	NTN
4T-3821		85,725		23,812		0,29	29	NTN
4T-382A		96,863		15,875		0,18	29	NTN
4T-382S		96,838		20,274		0,24	29	NTN
4T-383A		100,000		17,826		0,26	29	NTN
4T-385	55,000		21,946			0,43	29	NTN
4T-385/382A	55,000	96,838	21,946	15,875	21,000	0,62	29	NTN
CR1-3852	190,000	340,000	204,000			75,40	30	NTN
4T-385A	50,800		21,946			0,49	29	NTN
4T-385A/382A	50,800	96,838	21,946	15,875	21,000	0,68	29	NTN
4T-385X	55,000		21,946			0,43	29	NTN
4T-386A	47,625		21,946			0,54	29	NTN
4T-386A/382A	47,625	96,838	21,946	15,875	21,946	0,71	29	NTN
4T-387	57,150		21,946			0,40	29	NTN
4T-387/382	57,150	98,425	21,946	17,826	21,946	0,62	29	NTN
4T-387/382A	57,150	96,838	21,946	15,875	21,000	0,58	29	NTN
4T-3872	34,925		30,162			0,61	29	NTN
4T-3872/3820	34,925	85,725	30,162	23,812	30,162	0,89	29	NTN
4T-3875	38,100		30,162			0,57	29	NTN
4T-3875/3820	38,100	85,725	30,162	23,812	30,162	0,86	29	NTN
4T-3876	38,100		30,162			0,57	29	NTN
4T-3876/3820	38,100	85,725	30,162	23,812	30,162	0,85	29	NTN
4T-3877	41,288		30,162			0,52	29	NTN
4T-3877/3820	41,275	85,725	30,162	23,812	30,162	0,79	29	NTN
4T-387A	57,150		21,946			0,40	29	NTN
4T-387A/382	57,150	98,425	21,946	17,826	21,946	0,62	29	NTN
4T-387A/382A	57,150	96,838	21,946	15,875	21,946	0,57	29	NTN
4T-387A/382S	57,150	96,838	21,946	20,274	25,400	0,66	29	NTN
4T-387A/383A	57,150	100,000	21,946	17,826	21,946	0,65	29	NTN
4T-387AS	57,163		21,946			0,39	29	NTN
4T-387AS/382A	57,150	96,838	21,946	15,875	21,946	0,57	29	NTN
4T-387S	57,150		21,946			0,40	29	NTN
4T-387S/382A	57,150	96,838	21,946	15,875	21,000	0,59	29	NTN
4T-3880	41,288		30,162			0,52	29	NTN
4T-3880/3820	41,275	85,725	30,162	23,812	30,162	0,81	29	NTN

Reference						Kg	 Brands	
	d	D	B	C	T			
T-38880/38820	263,525	325,438	28,575	25,400	28,575	4,56	29	NTN
T-38885/38820	266,700	325,438	28,575	25,400	28,575	4,35	29	NTN
4T-388A	57,531		21,946			0,39	29	NTN
4T-388A/382	57,531	98,425	21,946	17,826	21,946	0,61	29	NTN
4T-388A/382A	57,531	96,838	21,946	15,875	21,000	0,58	29	NTN
4T-389	55,575		21,946			0,42	29	NTN
4T-389/382A	55,575	96,838	21,946	15,875	21,000	0,61	29	NTN
4T-389A	53,975		21,946			0,45	29	NTN
4T-389A/382	53,975	98,425	21,946	17,826	21,946	0,67	29	NTN
4T-389A/382A	53,975	96,838	21,946	15,857	21,000	0,63	29	NTN
4T-390	57,150		21,996			0,69	29	NTN
4T-390/394A	57,150	110,000	21,996	18,824	22,000	0,95	29	NTN
CRD-3906	195,000	305,000	120,000			32,50	31	NTN
4T-390A	63,500		21,996			0,59	29	NTN
4T-390A/394A	63,500	110,000	21,996	18,824	22,000	0,85	29	NTN
4T-390A/394AB	63,500	114,673	21,996	18,824	21,996	0,88	29	NTN
CR-3913	196,850	241,300	23,017	17,462	23,812	2,11	29	NTN
CR-3914	196,850	241,300	23,017	17,462	23,812	2,14	29	NTN
4T-392	61,912		21,996			0,62	29	NTN
4T-392/3920	61,912	112,712	21,996	23,812	26,967	1,06	29	NTN
4T-392/394A	61,912	110,000	21,996	18,824	22,000	0,88	29	NTN
4T-3920		112,712		23,812		0,45	29	NTN
4T-3925		112,712		23,812		0,45	29	NTN
4T-39250	63,500		22,000			0,49	29	NTN
4T-39250/39412	63,500	104,775	22,000	15,875	22,000	0,67	29	NTN
4T-394		110,000		22,000		0,28	29	NTN
4T-39412		104,775		15,875		0,18	29	NTN
4T-394A		110,000		18,824		0,26	29	NTN
4T-394AB		110,000		18,824		0,29	29	NTN
4T-394AS		110,025		18,824		0,26	29	NTN
4T-394CS		113,487		18,824		0,35	29	NTN
4T-395	63,500		21,996			0,59	29	NTN
4T-395/394	63,500	110,000	21,996	22,000	22,000	0,79	29	NTN
4T-395/394A	63,500	110,000	21,996	18,824	22,000	0,84	29	NTN
4T-39520		112,712		23,812		0,35	29	NTN
4T-39521		112,712		23,812		0,36	29	NTN
4T-39573	50,800		30,162			0,89	29	NTN
4T-39573/39520	50,800	112,712	30,162	23,812	30,162	1,25	29	NTN
4T-39575/39520	50,800	112,712	30,162	23,812	30,162	1,54	29	NTN
4T-39580	57,150		30,162			1,04	29	NTN
4T-39580/39520	57,150	112,712	30,162	23,812	30,162	1,41	29	NTN
4T-39581	57,150		30,162			1,03	29	NTN
4T-39581/39520	57,150	112,712	30,162	23,812	30,162	1,40	29	NTN
4T-39585	63,500		30,162			0,90	29	NTN
4T-39585/39520	63,500	112,712	30,162	23,812	30,162	1,27	29	NTN
4T-39590	66,675		30,162			0,83	29	NTN
4T-39590/39520	66,675	112,712	30,162	23,812	30,162	1,19	29	NTN
4T-395A	66,675		21,996			0,53	29	NTN
4T-395A/394	66,675	110,000	21,996	22,000	22,000	0,79	29	NTN
4T-395A/394A	66,675	110,000	21,996	18,824	22,000	0,79	29	NTN
4T-395CS/394CS	66,675	113,487	23,447	18,824	22,000	0,91	29	NTN
4T-395S	66,675		21,996			0,53	29	NTN





Reference	d D		B	C	T	Kg	Brands	
	d	D	B	C	T			
4T-395S/394A	66,675	110,000	21,996	18,824	22,000	0,79	29	NTN
4T-396	50,000		21,996			0,80	29	NTN
4T-396/394A	50,000	110,000	21,996	18,824	22,000	1,06	29	NTN
4T-397	60,000		21,996			0,65	29	NTN
4T-397/394A	60,000	110,000	21,996	18,824	22,000	0,91	29	NTN
4T-3975/3920	50,800	112,712	30,048	23,812	30,162	1,53	29	NTN
4T-3979	57,150		30,048			0,94	29	NTN
4T-3979/3920	57,150	112,712	30,048	23,812	30,162	1,38	29	NTN
4T-3980	60,325		30,048			0,87	29	NTN
4T-3980/3920	60,325	112,712	30,048	23,812	30,162	1,30	29	NTN
4T-3981	58,738		30,048			0,91	29	NTN
4T-3982	63,500		30,048			0,80	29	NTN
4T-3982/3920	63,500	112,712	30,048	23,812	30,162	1,25	29	NTN
4T-3982X/3927XS	63,500	110,000	30,048	23,812	30,162	1,13	29	NTN
4T-3984	66,675		30,048			0,73	29	NTN
4T-3984/3920	66,675	112,712	30,048	23,812	30,162	1,17	29	NTN
4T-3984/3925	66,675	112,712	30,048	23,812	30,162	1,19	29	NTN
4T-3994	66,675		30,048			0,72	29	NTN
4T-3994/3920	66,675	112,712	30,048	23,812	30,162	1,18	29	NTN
4T-399A	68,262		21,996			0,50	29	NTN
4T-399A/394A	68,262	110,000	21,996	18,824	22,000	0,76	29	NTN
4T-399AS	68,262		21,996			0,49	29	NTN
4T-399AS/394A	68,262	110,000	21,996	18,824	22,000	0,75	29	NTN
CRO-4013	200,000	290,000	160,000			35,10	32	NTN
E-CRO-4013	200,000	290,000	160,000			35,10	32	NTN
CRO-4014	200,000	310,000	200,000			54,00	32	NTN
E-CRO-4014	200,000	310,000	200,000			48,40	32	NTN
CRD-4015	200,000	340,000	150,000			55,30	31	NTN
CRD-4019	200,000	340,000	140,000			52,10	31	NTN
CRI-4019	200,000	340,000	184,000			67,00	30	NTN
CRD-4020	200,000	420,000	235,000			158,00	31	NTN
CRI-4020	200,000	310,000	151,000			38,20	30	NTN
CRO-4022LL	200,000	282,000	206,000			39,00	32	NTN
CRI-4027	200,000	310,000	170,000			42,40	30	NTN
CR1-4030	200,000	330,000	180,000			55,50	30	NTN
CRI-4030	200,000	330,000	180,000			55,50	30	NTN
CRI-4036	200,000	320,000	146,000			40,10	30	NTN
4T-A4050	12,700		10,988			0,03	29	NTN
4T-A4050/A4138	12,700	34,988	10,988	8,730	10,998	0,05	29	NTN
4T-A4059	15,000		10,988			0,03	29	NTN
4T-A4059/A4138	14,989	34,988	10,988	8,730	10,988	0,05	29	NTN
CRI-4107	206,000	283,000	102,000			16,90	30	NTN
CRT4107	203,200	419,100	92,075			66,10	37	NTN
E-CRT4112	203,200	419,100	92,075			54,40	37	NTN
4T-41125	28,575		24,257			0,29	29	NTN
4T-41125/41286	28,575	72,626	24,257	17,462	24,608	0,47	29	NTN
4T-41286		72,626		17,462		0,18	29	NTN
4130/500	500,000	720,000	167,000			202,00	30	NTN
4130/530	530,000	780,000	185,000			265,00	30	NTN
4130/600	600,000	870,000	200,000			348,00	30	NTN
4130/710G2	710,000	1 030,000	236,000			640,00	30	NTN
413024	120,000	180,000	46,000			3,85	30	NTN

Reference						Kg		Brands
	d	D	B	C	T			
413026	130,000	200,000	52,000			5,55	30	NTN
413028	140,000	210,000	53,000			5,88	30	NTN
413030	150,000	225,000	56,000			6,66	30	NTN
413032	160,000	240,000	60,000			8,29	30	NTN
413034	170,000	260,000	67,000			11,60	30	NTN
413036	180,000	280,000	74,000			13,40	30	NTN
413036	180,000	280,000	74,000			15,90	30	NTN
413038	190,000	290,000	75,000			16,20	30	NTN
413040	200,000	310,000	82,000			20,70	30	NTN
413044	220,000	340,000	90,000			26,70	30	NTN
413044	220,000	340,000	90,000			26,70	30	NTN
413048	240,000	360,000	92,000			28,70	30	NTN
413052	260,000	400,000	104,000			41,50	30	NTN
413056	280,000	420,000	106,000			47,20	30	NTN
413060	300,000	460,000	118,000			64,40	30	NTN
413064	320,000	480,000	121,000			70,90	30	NTN
413068	340,000	520,000	133,000			89,20	30	NTN
413072	360,000	540,000	134,000			98,20	30	NTN
413076	380,000	560,000	135,000			95,90	30	NTN
413080	400,000	600,000	148,000			105,00	30	NTN
413084	420,000	620,000	150,000			135,00	30	NTN
413088	440,000	650,000	157,000			160,00	30	NTN
413092	460,000	680,000	163,000			179,00	30	NTN
4131/500	500,000	830,000	264,000			528,00	30	NTN
4131/530G2	530,000	870,000	272,000			620,00	30	NTN
4131/560	560,000	920,000	280,000			1 310,00	30	NTN
4131/600G2	600,000	980,000	300,000			858,00	30	NTN
4131/670G2	670,000	1 090,000	336,000			1 180,00	30	NTN
413122	110,000	180,000	56,000			5,20	30	NTN
413124	120,000	200,000	62,000			7,20	30	NTN
413126	130,000	210,000	64,000			7,83	30	NTN
413128	140,000	225,000	68,000			9,24	30	NTN
413130	150,000	250,000	80,000			14,30	30	NTN
413132	160,000	270,000	86,000			18,10	30	NTN
413132	160,000	270,000	86,000			18,20	30	NTN
413134	170,000	280,000	88,000			18,90	30	NTN
413134	170,000	280,000	88,000			19,50	30	NTN
413136	180,000	300,000	96,000			24,60	30	NTN
413138	190,000	320,000	104,000			30,80	30	NTN
413140	200,000	340,000	112,000			38,60	30	NTN
413144	220,000	370,000	120,000			47,10	30	NTN
413148	240,000	400,000	128,000			58,90	30	NTN
413152	260,000	440,000	144,000			80,00	30	NTN
413156	280,000	460,000	146,000			87,40	30	NTN
413160	300,000	500,000	160,000			112,30	30	NTN
413164	320,000	540,000	176,000			150,00	30	NTN
413168	340,000	580,000	190,000			188,00	30	NTN
413172	360,000	600,000	192,000			199,00	30	NTN
413176	380,000	620,000	194,000			206,00	30	NTN
413180	400,000	650,000	200,000			236,00	30	NTN
413184	420,000	700,000	224,000			317,00	30	NTN
413188	440,000	720,000	226,000			330,00	30	NTN





Reference	d		D		B	C	T	Kg	30	Brands
	d	D	B	C	T					
413192	460,000	760,000	240,000				395,00	30	NTN	
413196	480,000	790,000	248,000				442,00	30	NTN	
4T-A4138		34,988			8,730		0,02	29	NTN	
4T-414		88,501			22,225		0,33	29	NTN	
4T-H414210		136,525			31,750		0,79	29	NTN	
4T-H414242	66,675		41,275				1,89	29	NTN	
4T-H414242/H414210	66,675	136,525	41,275	31,750	41,275		2,75	29	NTN	
4T-H414245	68,262		41,275				1,89	29	NTN	
4T-H414245/H414210	68,262	136,525	41,275	31,750	41,275		2,70	29	NTN	
4T-H414249	71,438		41,275				1,78	29	NTN	
4T-H414249/H414210	71,438	136,525	41,275	31,750	41,275		2,58	29	NTN	
4T-414A		88,501			22,225		0,32	29	NTN	
4T-JH415610		145,000			42,000		1,19	29	NTN	
4T-JH415647	75,000		51,000				2,63	29	NTN	
4T-JH415647/JH415610	75,000	145,000	51,000	42,000	51,000		3,77	29	NTN	
4T-418	38,100		29,083				0,51	29	NTN	
4T-418/414	38,100	88,500	29,083	22,225	26,988		0,84	29	NTN	
4T-420	40,000		29,083				0,48	29	NTN	
4T-420/414	40,000	88,500	29,083	22,225	26,988		0,81	29	NTN	
CRI-4202	210,000	355,000	116,000				44,00	30	NTN	
4T-L420449/L420410	101,600	136,525	21,433	16,670	21,433		0,82	29	NTN	
4T-LL420549/LL420510	101,600	134,938	15,083	11,908	15,875		0,55	29	NTN	
T-EE420750D/421437+A	190,500	365,049	152,400				72,80	31	NTN	
T-EE420751/421437	190,500	365,049	88,897	63,500	92,075		42,90	29	NTN	
T-EE420751/421451D+A	190,500	368,300	193,675				84,10	30	NTN	
E-EE420751/421451D+A	190,500	368,300	193,675				84,10	30	NTN	
T-EE420800D/421437+A	203,200	365,049	152,400				69,00	31	NTN	
E-EE420801	203,200		88,897				24,90	29	NTN	
T-EE420801/421437	203,200	365,049	88,897	63,500	92,075		40,70	29	NTN	
E-EE420801/421451CD+A	203,200	368,300	193,675				79,20	30	NTN	
T-EE420801/421451D+A	203,200	368,300	193,675				79,90	30	NTN	
CRD-4209	210,000	480,000	230,000				212,00	31	NTN	
4T-HH421210		184,150			52,388		2,55	29	NTN	
4T-HH421246	98,425		63,500				4,98	29	NTN	
4T-HH421246/HH421210	98,425	184,150	63,500	52,388	63,500		7,53	29	NTN	
4230/500	500,000	720,000	209,000				247,00	30	NTN	
4230/530	530,000	780,000	231,000				331,00	30	NTN	
423024	120,000	180,000	58,000				4,41	30	NTN	
423026	130,000	200,000	65,000				6,62	30	NTN	
423028	140,000	210,000	66,000				7,11	30	NTN	
423030	150,000	225,000	70,000				8,42	30	NTN	
423032	160,000	240,000	75,000				10,70	30	NTN	
423034	170,000	260,000	84,000				13,90	30	NTN	
423036	180,000	280,000	93,000				18,50	30	NTN	
423036	180,000	280,000	93,000				19,00	30	NTN	
423038	190,000	290,000	94,000				19,10	30	NTN	
423038	190,000	290,000	94,000				19,60	30	NTN	
423040	200,000	310,000	103,000				24,60	30	NTN	
423040	200,000	310,000	103,000				25,70	30	NTN	
423044	220,000	340,000	113,000				32,70	30	NTN	
423044	220,000	340,000	113,000				33,30	30	NTN	
423048	240,000	360,000	115,000				35,60	30	NTN	

Reference						Kg	?	Brands
	d	D	B	C	T			
423048	240,000	360,000	115,000			36,30	30	NTN
423052	260,000	400,000	130,000			52,30	30	NTN
423056	280,000	420,000	133,000			57,30	30	NTN
423060	300,000	460,000	148,000			76,70	30	NTN
423064	320,000	480,000	151,000			85,40	30	NTN
423068	340,000	520,000	165,000			113,00	30	NTN
423072	360,000	540,000	169,000			120,00	30	NTN
423076	380,000	560,000	171,000			126,00	30	NTN
423080	400,000	600,000	185,000			163,00	30	NTN
423084	420,000	620,000	188,000			172,00	30	NTN
423088	440,000	650,000	196,000			198,00	30	NTN
423092	460,000	680,000	204,000			223,30	30	NTN
423096	480,000	700,000	206,000			236,00	30	NTN
4231/500G2	500,000	830,000	330,000			678,00	30	NTN
4231/530AG2	530,000	870,000	340,000			774,00	30	NTN
4231/560G2	560,000	920,000	350,000			894,00	30	NTN
4231/600G2	600,000	980,000	388,000			1 050,00	30	NTN
4231/670G2	670,000	1 090,000	392,000			1 410,00	30	NTN
423122	110,000	180,000	70,000			6,28	30	NTN
423124	120,000	200,000	78,000			8,96	30	NTN
423126	130,000	210,000	80,000			9,77	30	NTN
423128	140,000	225,000	84,000			11,80	30	NTN
423130	150,000	250,000	100,000			18,00	30	NTN
423132	160,000	270,000	108,000			22,10	30	NTN
423132	160,000	270,000	108,000			22,80	30	NTN
423134	170,000	280,000	110,000			23,00	30	NTN
423134	170,000	280,000	110,000			24,70	30	NTN
423136	180,000	300,000	120,000			31,40	30	NTN
423136	180,000	300,000	120,000			31,40	30	NTN
423138	190,000	320,000	130,000			37,30	30	NTN
423140	200,000	340,000	140,000			47,50	30	NTN
423144	220,000	370,000	150,000			59,60	30	NTN
423148	240,000	400,000	160,000			71,70	30	NTN
423152	260,000	440,000	180,000			99,80	30	NTN
423156	280,000	460,000	183,000			109,00	30	NTN
423160	300,000	500,000	200,000			144,00	30	NTN
423164	320,000	540,000	220,000			186,00	30	NTN
423168	340,000	580,000	238,000			228,70	30	NTN
423172	360,000	600,000	240,000			248,00	30	NTN
423176	380,000	620,000	243,000			262,00	30	NTN
423180	400,000	650,000	250,000			294,00	30	NTN
423184	420,000	700,000	280,000			394,00	30	NTN
423188	440,000	720,000	283,000			412,00	30	NTN
423192	460,000	760,000	300,000			493,00	30	NTN
423196	480,000	790,000	310,000			548,00	30	NTN
4T-42346	87,960		28,971			1,44	29	NTN
4T-42346/42584	87,960	148,430	28,971	21,433	28,575	1,99	29	NTN
4T-42350	88,900		28,971			1,41	29	NTN
4T-42350/42584	88,900	148,430	28,971	21,433	28,971	1,96	29	NTN
4T-42350/42587D+A	88,900	149,225	66,672			4,50	30	NTN
4T-42362	92,075		28,971			1,30	29	NTN
4T-42362/42587D+A	92,075	149,225	66,672			4,23	30	NTN





Reference	d		D		B	C	T	Kg	?	Brands
	d	D	B	C	T					
4T-42368	93,662		28,971				1,25	29	NTN	
4T-42368/42584	93,662	148,430	28,971	21,433	28,575		1,80	29	NTN	
4T-42375	95,250		28,971				1,20	29	NTN	
4T-42375/42584	95,250	148,430	28,971	21,433	28,575		1,75	29	NTN	
4T-42376	95,250		28,971				1,19	29	NTN	
4T-42381	96,838		28,971				1,12	29	NTN	
4T-42381/42584	96,838	148,430	28,971	21,433	28,971		1,69	29	NTN	
4T-42381/42587	96,838	149,225	28,971	24,608	31,750		1,85	29	NTN	
4T-42584		148,430		21,433			0,54	29	NTN	
4T-42587		149,225		24,608			0,71	29	NTN	
4T-42587B		149,225		24,608			0,71	29	NTN	
4T-42620		127,000		22,225			0,42	29	NTN	
EE426200/426330	508,000	838,200	139,700	104,775	146,050		296,00	29	NTN	
EE426200/426331D+A	508,000	838,200	304,800				592,00	30	NTN	
4T-42687	76,200		31,000				1,01	29	NTN	
4T-42687/42620	76,200	127,000	31,000	22,225	31,000		1,44	29	NTN	
4T-42688	76,200		31,000				0,99	29	NTN	
4T-42688/42620	76,200	127,000	31,000	22,225	31,000		1,42	29	NTN	
4T-42690	77,788		31,000				0,96	29	NTN	
4T-42690/42620	77,788	127,000	31,000	22,225	31,000		1,39	29	NTN	
4T-430208X	40,000	80,000	45,000				0,93	30	NTN	
430208XU	40,000	80,000	45,000				18,00	30	NTN	
4T-430209	45,000	85,000	47,000				1,04	30	NTN	
430209U	45,000	85,000	47,000				1,06	30	NTN	
4T-430210	50,000	90,000	49,000				1,18	30	NTN	
430210U	50,000	90,000	49,000				1,18	30	NTN	
4T-430211X	55,000	100,000	51,000				1,55	30	NTN	
430211XU	55,000	100,000	51,000				1,56	30	NTN	
4T-430212X	60,000	110,000	53,000				1,99	30	NTN	
430212XU	60,000	110,000	53,000				1,98	30	NTN	
4T-430213X	65,000	120,000	56,000				2,49	30	NTN	
430213XU	65,000	120,000	56,000				2,54	30	NTN	
4T-430214	70,000	125,000	59,000				2,67	30	NTN	
430214U	70,000	125,000	59,000				2,80	30	NTN	
4T-430215	75,000	130,000	62,000				2,99	30	NTN	
430215U	75,000	130,000	62,000				3,08	30	NTN	
430216XU	80,000	140,000	64,000				3,70	30	NTN	
430217XU	85,000	150,000	70,000				4,59	30	NTN	
430218U	90,000	160,000	74,000				5,76	30	NTN	
430219XU	95,000	170,000	78,000				8,01	30	NTN	
430220XU	100,000	180,000	83,000				8,11	30	NTN	
430221XU	105,000	190,000	88,000				9,73	30	NTN	
430222XU	110,000	200,000	92,000				11,40	30	NTN	
430224XU	120,000	215,000	97,000				13,60	30	NTN	
430226XU	130,000	230,000	98,000				15,01	30	NTN	
430228XU	140,000	250,000	102,000				19,90	30	NTN	
430230U	150,000	270,000	109,000				24,40	30	NTN	
430232U	160,000	290,000	115,000				31,90	30	NTN	
430234U	170,000	310,000	125,000				38,00	30	NTN	
430236	180,000	320,000	127,000				37,50	30	NTN	
430236U	180,000	320,000	127,000				39,40	30	NTN	
430238U	190,000	340,000	133,000				45,50	30	NTN	

Reference						Kg	 Brands	
	d	D	B	C	T			
430240	200,000	360,000	142,000			55,60	30	NTN
430240U	200,000	360,000	142,000			62,80	30	NTN
430244	220,000	400,000	158,000			76,30	30	NTN
430248	240,000	440,000	165,000			100,40	30	NTN
430305DX	25,000	62,000	40,000			0,25	30	NTN
4T-430306DX	30,000	72,000	45,000			0,84	30	NTN
4T-430308	40,000	90,000	56,000			1,61	30	NTN
4T-430308DX	40,000	90,000	56,000			1,56	30	NTN
430308U	40,000	90,000	56,000			1,61	30	NTN
4T-430309	45,000	100,000	60,000			2,11	30	NTN
4T-430310	50,000	110,000	64,000			2,72	30	NTN
4T-430310DX	50,000	110,000	64,000			2,65	30	NTN
430310U	50,000	110,000	64,000			2,76	30	NTN
4T-430311DX	55,000	120,000	70,000			3,42	30	NTN
430311XU	55,000	120,000	70,000			3,54	30	NTN
4T-430312DX	60,000	130,000	74,000			4,22	30	NTN
430312U	60,000	130,000	74,000			4,31	30	NTN
4T-430313DX	65,000	140,000	79,000			5,16	30	NTN
430313XU	65,000	140,000	79,000			5,41	30	NTN
4T-430314DX	70,000	150,000	83,000			6,23	30	NTN
430314DXU	70,000	150,000	83,000			6,42	30	NTN
430314XU	70,000	150,000	83,000			6,37	30	NTN
430315DU	75,000	160,000	87,000			7,31	30	NTN
430315XU	75,000	160,000	87,000			7,71	30	NTN
430316DU	80,000	170,000	92,000			8,99	30	NTN
430316XU	80,000	170,000	92,000			9,10	30	NTN
430317DU	85,000	180,000	98,000			10,60	30	NTN
430317XU	85,000	180,000	98,000			12,44	30	NTN
430318DU	90,000	190,000	102,000			12,50	30	NTN
430318U	90,000	190,000	102,000			12,34	30	NTN
430319XU	95,000	200,000	108,000			15,00	30	NTN
430320XU	100,000	215,000	112,000			18,40	30	NTN
430321XU	105,000	225,000	116,000			21,00	30	NTN
430322	110,000	240,000	118,000			22,10	30	NTN
430322U	110,000	240,000	118,000			24,50	30	NTN
430324XU	120,000	260,000	128,000			30,50	30	NTN
430326XU	130,000	280,000	137,000			37,90	30	NTN
430328XU	140,000	300,000	145,000			46,60	30	NTN
430330	150,000	320,000	154,000			52,80	30	NTN
430330U	150,000	320,000	154,000			55,40	30	NTN
430332XU	160,000	340,000	160,000			65,50	30	NTN
CRO-4303LL	216,103	330,200	263,525			78,20	32	NTN
EE430900/431575	228,600	400,050	87,312	63,500	88,900	46,00	29	NTN
EE430900/431576D+A	228,600	400,050	187,325			88,30	30	NTN
4T-43125	31,750		24,074			0,37	29	NTN
4T-43125/43312	31,750	79,375	24,074	17,462	25,400	0,58	29	NTN
4T-43131	33,338		24,074			0,35	29	NTN
4T-43131/43312	33,338	79,375	24,074	17,462	25,400	0,57	29	NTN
4T-43131/43312B	33,338	79,375	24,074	17,462	25,400	0,60	29	NTN
4T-43138X	35,000		23,282			0,32	29	NTN
4T-432		95,250		22,225		0,38	29	NTN
4T-432208X	40,000	80,000	55,000			1,18	30	NTN





Reference	d		D		B	C	T	Kg	Brands	
432208XU	40,000	80,000	55,000					1,16	30	NTN
4T-432209	45,000	85,000	55,000					1,27	30	NTN
432209U	45,000	85,000	55,000					1,27	30	NTN
432210U	50,000	90,000	55,000					1,36	30	NTN
432211U	55,000	100,000	60,000					1,85	30	NTN
432212U	60,000	110,000	66,000					2,51	30	NTN
432213U	65,000	120,000	73,000					3,33	30	NTN
432214U	70,000	125,000	74,000					3,56	30	NTN
432215U	75,000	130,000	74,000					3,68	30	NTN
432216XU	80,000	140,000	78,000					4,53	30	NTN
432217XU	85,000	150,000	86,000					5,85	30	NTN
432218U	90,000	160,000	94,000					7,35	30	NTN
432219XU	95,000	170,000	100,000					9,04	30	NTN
432220XU	100,000	180,000	107,000					10,50	30	NTN
432221XU	105,000	190,000	115,000					13,10	30	NTN
432222XU	110,000	200,000	121,000					14,80	30	NTN
432224XU	120,000	215,000	132,000					18,90	30	NTN
432226XU	130,000	230,000	145,000					23,00	30	NTN
432228XU	140,000	250,000	153,000					30,10	30	NTN
432230XU	150,000	270,000	164,000					8,40	30	NTN
432232U	160,000	290,000	178,000					46,90	30	NTN
432234XU	170,000	310,000	192,000					60,40	30	NTN
432236U	180,000	320,000	192,000					60,60	30	NTN
432238	190,000	340,000	204,000					75,00	30	NTN
432238U	190,000	340,000	204,000					73,30	30	NTN
432240	200,000	360,000	218,000					90,70	30	NTN
432240U	200,000	360,000	218,000					95,20	30	NTN
432248	240,000	440,000	266,000					164,80	30	NTN
4T-L432310		205,583		18,258				0,60	29	NTN
432310U	50,000	110,000	90,000					3,98	30	NTN
432311U	55,000	120,000	97,000					5,05	30	NTN
432312U	60,000	130,000	104,000					6,29	30	NTN
432313U	65,000	140,000	108,000					7,55	30	NTN
432314U	70,000	150,000	116,000					9,28	30	NTN
432315U	75,000	160,000	125,000					11,50	30	NTN
432316U	80,000	170,000	131,000					13,60	30	NTN
432317U	85,000	180,000	137,000					15,40	30	NTN
432318U	90,000	190,000	144,000					18,20	30	NTN
432319U	95,000	200,000	151,000					21,50	30	NTN
432320U	100,000	215,000	162,000					26,50	30	NTN
432321	105,000	225,000	170,000					30,20	30	NTN
432322	110,000	240,000	181,000					35,60	30	NTN
432322U	110,000	240,000	181,000					38,20	30	NTN
432324U	120,000	260,000	188,000					47,00	30	NTN
432326	130,000	280,000	205,000					56,60	30	NTN
4T-L432349	158,750		23,812					1,40	29	NTN
4T-L432349/L432310	158,750	205,583	23,812	18,258	23,812			1,89	29	NTN
4T-43312		79,375		17,462				0,22	29	NTN
4T-4335		90,513		33,338				0,46	29	NTN
4T-L433749/L433710	165,100	215,900	26,195	20,638	26,195			2,33	29	NTN
EE435102/435165	260,350	419,100	84,138	61,912	85,725			44,40	29	NTN
EE435102/435165D+A	260,350	419,100	184,150					86,80	30	NTN

Reference						Kg	?	Brands
	d	D	B	C	T			
4T-436	46,038		29,900			0,54	29	NTN
4T-436/432	46,038	95,250	29,900	22,225	27,783	0,93	29	NTN
4T-4370/4320	44,450	88,500	40,386	33,338	40,386	1,12	29	NTN
4T-4375	38,100		40,386			0,86	29	NTN
T-HH437549/HH437510	165,100	336,550	95,250	69,850	92,075	36,60	29	NTN
4T-438	44,450		29,900			0,57	29	NTN
4T-438/432	44,450	95,250	29,900	22,225	27,783	0,95	29	NTN
4T-4388	41,275		40,386			0,79	29	NTN
4T-4388/4335	41,275	90,488	40,386	33,338	40,386	1,25	29	NTN
4T-4395/4335	42,070	90,488	40,386	33,338	39,688	1,24	29	NTN
CRD-4405	220,000	320,000	76,200			20,30	31	NTN
CRT4405	220,000	370,000	90,000			31,00	37	NTN
CRTD4406	220,000	300,000	96,000			19,00	38	NTN
CRI-4407	220,000	420,000	130,000			73,10	30	NTN
CRI-4409	220,000	340,000	158,000			46,70	30	NTN
CRO-4409	220,000	340,000	194,000			64,50	32	NTN
CRI-4410	220,000	300,000	110,000			21,10	30	NTN
CR-4411	219,969	290,010	31,750	25,000	31,750	5,46	29	NTN
CRI-4411	220,000	340,000	164,000			48,50	30	NTN
CRO-4411	220,000	320,000	200,000			53,00	32	NTN
CRO-4412	220,000	300,000	230,000			42,10	32	NTN
4T-44143	36,512		23,698			0,48	29	NTN
4T-44143/44348	36,512	88,500	23,698	17,462	25,400	0,73	29	NTN
E-CRI-4414LL	220,000	550,000	220,000			305,00	30	NTN
4T-44150	38,100		23,698			0,47	29	NTN
4T-44150/44348	38,100	88,501	23,698	17,462	25,400	0,71	29	NTN
4T-44158/44348	39,688	88,500	23,698	17,462	25,400	0,69	29	NTN
CRI-4416	220,000	370,000	150,000			59,00	30	NTN
4T-44162	41,275		23,698			0,43	29	NTN
4T-44162/44348	41,275	88,500	23,698	17,462	25,400	0,67	29	NTN
E-CRI-4417	220,000	400,000	210,000			107,00	30	NTN
CRD-4418	220,000	400,000	254,000			138,00	31	NTN
CRO-4424LL	220,000	295,000	315,000			57,50	32	NTN
CRO-4427LL	220,000	310,000	280,000			63,50	32	NTN
4T-443	31,750		29,900			0,75	29	NTN
4T-443/432	31,750	95,250	29,900	22,225	27,783	1,13	29	NTN
4T-44348		88,500		17,462		0,24	29	NTN
CRO-4436LL	220,000	320,000	290,000			77,00	32	NTN
4T-L44610		50,292		10,668		0,04	29	NTN
LM446349/LM446310	234,950	311,150	46,038	33,338	46,038	8,38	29	NTN
LM446349/LM446310D+A	234,950	311,150	98,425			17,90	30	NTN
4T-L44640	23,812		14,732			0,10	29	NTN
4T-L44640/L44610	23,812	50,292	14,732	10,668	14,224	0,14	29	NTN
4T-L44643	25,400		14,732			0,09	29	NTN
4T-L44643L	25,400		14,732			0,09	29	NTN
4T-L44643/L44610	25,400	50,292	14,732	10,668	14,732	0,13	29	NTN
4T-L44643L/L44610	25,400	50,292	14,732	10,668	14,732	0,13	29	NTN
4T-L44649	26,988		14,732			0,08	29	NTN
4T-L44649/L44610	26,988	50,292	14,732	10,668	14,732	0,12	29	NTN
T-EE450601/451212	152,400	307,975	93,662	61,912	88,900	29,40	29	NTN
T-EE450601/451215D+A	152,400	307,975	200,025			62,60	30	NTN
T-450900D/451212+A	152,400	307,975	171,450			60,50	31	NTN





Reference	d		D		B	C	T	Kg	Brands
	d	D	B	C	T				
LM451345/LM451310A	263,525	355,600	57,150	44,450	57,150	15,77	29	NTN	
T-LM451345/LM451310	263,525	355,600	57,150	44,450	57,150	14,20	29	NTN	
T-LM451345/LM451310D+A	263,525	355,600	127,000			31,70	30	NTN	
4T-LM451349/LM451310	266,700	355,600	57,150	44,450	57,150	14,90	29	NTN	
LM451349/LM451310A	266,700	355,600	57,150	44,450	57,150	14,96	29	NTN	
T-LM451349/LM451310	266,700	355,600	57,150	44,450	57,150	15,00	29	NTN	
T-LM451349/LM451310D+A	266,700	355,600	127,000			30,70	30	NTN	
T-LM451349A/LM451310	266,700	355,600	57,150	44,450	57,150	13,80	29	NTN	
E-LM451349D/LM451310/LM451310D	266,700	355,600	230,188			61,53	32	NTN	
T-E-LM451349D/LM451310/LM451310D	266,700	355,600	230,188			62,00	32	NTN	
T-LM451349D/LM451310/LM451310D (CRO-5307)	266,700	355,600	230,188			62,00	32	NTN	
T-LM451349D/LM451310+A	266,700	355,600	109,538			29,90	31	NTN	
4T-45220		104,775		23,812		0,34	29	NTN	
4T-45221		104,775		23,812		0,35	29	NTN	
4T-45280	44,450		30,958			0,99	29	NTN	
4T-45280/45220	44,450	104,775	30,958	23,812	30,162	1,35	29	NTN	
4T-45282	47,625		30,958			0,93	29	NTN	
4T-45282/45220	47,625	104,775	30,958	23,812	30,162	1,29	29	NTN	
4T-45284	50,800		30,958			0,86	29	NTN	
4T-45284/45220	50,800	104,775	30,958	23,812	30,162	1,20	29	NTN	
4T-45285	50,800		30,958			0,88	29	NTN	
4T-45285/45220	50,800	104,775	30,958	23,812	30,162	1,22	29	NTN	
4T-45285A/45220B	50,800	110,231	30,958	23,812	30,162	1,26	29	NTN	
4T-45287	53,975		30,958			0,82	29	NTN	
4T-45287/45220	53,975	104,775	30,958	23,812	30,162	1,17	29	NTN	
4T-45289	57,150		30,958			0,75	29	NTN	
4T-45289/45220	57,150	104,775	30,958	23,812	30,162	1,09	29	NTN	
4T-45290	57,150		30,958			0,74	29	NTN	
4T-45290/45220	57,150	104,775	30,958	23,812	30,958	1,08	29	NTN	
4T-45291	57,150		30,958			0,73	29	NTN	
4T-45291/45220	57,150	104,775	30,958	23,812	30,958	1,07	29	NTN	
4T-452A		107,950		27,000		0,49	29	NTN	
4T-453		107,950		27,000		0,48	29	NTN	
4T-453A		107,975		22,225		0,42	29	NTN	
4T-453X		104,775		24,605		0,37	29	NTN	
4T-454		110,000		27,000		0,55	29	NTN	
4T-L45410		50,292		10,668		0,04	29	NTN	
4T-L45449	29,000		14,732			0,08	29	NTN	
4T-L45449/L45410	29,000	50,292	14,732	10,668	14,224	0,11	29	NTN	
4T-455	50,800		29,317			0,81	29	NTN	
4T-455/453X	50,800	104,775	29,317	24,605	30,162	1,19	29	NTN	
4T-456	53,975		29,317			0,74	29	NTN	
4T-456/453A	53,975	107,950	29,317	22,225	27,783	1,16	29	NTN	
4T-4580	50,800		40,157			1,04	29	NTN	
4T-4580/4535	50,800	104,775	40,157	33,338	39,688	1,62	29	NTN	
4T-460	44,450		29,371			0,92	29	NTN	
4T-460/453X	44,450	104,775	29,371	24,605	30,162	1,29	29	NTN	
CR1-4604	230,000	355,000	146,000			47,00	30	NTN	
CRD-4604	228,600	431,800	177,800			131,00	31	NTN	
CRT4604	228,600	482,600	104,775			93,20	37	NTN	
E-CRT4604	228,600	482,600	104,775			101,70	37	NTN	
CRI-4605	230,000	400,000	188,000			88,50	30	NTN	

Reference						Kg		Brands
	d	D	B	C	T			
CR1-4606	230,000	380,000	200,000			80,40	30	NTN
CRI-4606	230,000	380,000	200,000			84,40	30	NTN
CR0-4606	228,600	364,000	296,875			117,90	32	NTN
CR1-4612	230,000	380,000	175,000			66,97	30	NTN
CRI-4612	230,000	380,000	175,000			67,00	30	NTN
CR1-4613	230,000	380,000	175,000			73,90	30	NTN
4T-46143	36,512		31,750			0,76	29	NTN
4T-46143/46368	36,512	93,662	31,750	26,195	31,750	1,15	29	NTN
4T-46162	41,275		31,750			0,68	29	NTN
4T-46162/46368	41,275	93,662	31,750	26,195	31,750	1,09	29	NTN
4T-46175/46368	44,450	93,662	31,750	26,195	31,750	1,04	29	NTN
4T-46176	44,450		31,750			0,63	29	NTN
CR1-4619	230,000	380,000	175,000			68,60	30	NTN
4T-462	57,150		29,317			0,68	29	NTN
4T-462/453A	57,150	107,950	29,317	22,225	29,317	1,11	29	NTN
4T-462/453X	57,150	104,775	29,317	24,605	30,162	1,06	29	NTN
4T-462A	57,150		29,317			0,68	29	NTN
4T-462A/453X	57,150	104,775	29,317	24,605	30,162	1,05	29	NTN
4T-463/453X	47,625	104,775	29,317	24,605	30,162	1,24	29	NTN
4T-46368		93,662		26,195		0,40	29	NTN
4T-467	47,625		29,317			0,86	29	NTN
4T-46720		225,425		33,338		1,80	29	NTN
4T-46780	158,750		39,688			3,54	29	NTN
4T-46780/46720	158,750	225,425	39,688	33,338	41,275	5,20	29	NTN
4T-46780/46720D+A	158,750	225,425	85,725			10,80	30	NTN
4T-46790	165,100		39,688			3,04	29	NTN
4T-46790/46720	165,100	225,425	39,688	33,338	41,275	4,69	29	NTN
4T-46790/46720D+A	165,100	225,425	85,725			9,72	30	NTN
4T-NA46790SW/46720CD	165,100	225,425	95,250			9,87	30	NTN
T-46791D/46720/46721D	165,100	225,425	165,100			20,70	32	NTN
T-E-46791D/46720/46721D	165,100	225,425	165,100			20,70	32	NTN
4T-469	57,150		29,317			0,68	29	NTN
4T-469/453A	57,150	107,950	29,317	22,225	27,783	1,11	29	NTN
4T-469/453X	57,150	104,775	29,317	24,605	30,162	1,06	29	NTN
4T-469/454	57,150	110,000	29,317	27,000	27,795	1,24	29	NTN
E-LL469949/LL469910	447,675	552,450	41,618	32,545	44,450	20,80	29	NTN
E-CR1-4701	235,000	330,000	230,000			55,80	30	NTN
CRI-4701	235,000	330,000	115,000			27,30	30	NTN
4T-472		120,000		24,237		0,49	29	NTN
4T-472A		120,000		23,444		0,46	29	NTN
4T-47420		120,000		26,195		0,47	29	NTN
4T-47487	69,850		32,545			0,98	29	NTN
4T-47487/47420	69,850	120,000	32,545	26,195	32,545	1,47	29	NTN
4T-47490	71,438		32,545			0,98	29	NTN
4T-47490/47420	71,438	120,000	32,545	26,195	32,545	1,42	29	NTN
4T-47620		133,350		26,195		0,56	29	NTN
4T-47620A		133,350		26,195		0,58	29	NTN
L476549/L476510	549,275	692,150	80,962	61,912	80,962	68,20	29	NTN
L476549/L476510D+A	549,275	692,150	174,625			135,00	30	NTN
4T-47678	76,200		33,338			1,32	29	NTN
4T-47678/47620	76,200	133,350	33,338	26,195	33,338	1,92	29	NTN
4T-47679	76,200		33,338			1,34	29	NTN





Reference	d		D		B	C	T	Kg	Brands
	d	D	B	C	T				
4T-47679/47620	76,200	133,350	33,338	26,195	33,338	1,90	29	NTN	
4T-47680	76,200		33,338			1,37	29	NTN	
4T-47681	80,962		33,338			1,20	29	NTN	
4T-47681/47620	80,962	133,350	33,338	26,195	33,338	1,78	29	NTN	
4T-47686	82,550		33,338			1,14	29	NTN	
4T-47686/47620	82,550	133,350	33,338	26,195	33,338	1,72	29	NTN	
4T-47687	82,550		33,338			1,12	29	NTN	
4T-47687/47620	82,550	133,350	33,338	26,195	33,338	1,68	29	NTN	
4T-477/472	63,500	120,000	29,007	24,237	29,794	1,49	29	NTN	
4T-47820		146,050		26,195		0,66	29	NTN	
4T-47890	92,075		34,925			1,40	29	NTN	
4T-47890/47820	92,075	146,050	34,925	26,195	34,925	2,06	29	NTN	
4T-47896	95,250		34,925			1,28	29	NTN	
4T-47896/47820	95,250	146,050	34,925	26,195	34,925	1,94	29	NTN	
4T-480	68,262		29,007			0,88	29	NTN	
4T-480/472	68,262	120,000	29,007	24,237	29,794	1,37	29	NTN	
CRD-4803	241,300	355,524	109,538			36,80	31	NTN	
CRD-4804	240,000	395,000	124,000			60,20	31	NTN	
CR-4805	240,000	360,000	40,000	41,000	46,000	14,02	29	NTN	
CRD-4805	240,000	400,000	160,000			80,70	31	NTN	
CRI-4805	240,000	360,000	170,000			53,80	30	NTN	
CRI-4806	240,000	360,000	164,000			53,00	30	NTN	
CRI-4807	240,000	400,000	209,000			96,00	30	NTN	
CRD-4808	240,000	460,000	140,000			107,00	31	NTN	
E-CRD-4808	240,000	460,000	140,000			107,00	31	NTN	
CRD-4811	240,000	400,000	160,000			80,70	31	NTN	
CRO-4811LL	240,000	338,000	248,000			67,80	32	NTN	
4T-48120		161,925		26,988		0,83	29	NTN	
CRI-4813	240,000	320,000	110,000			21,60	30	NTN	
LL481448/LL481411	673,100	793,750	61,912	49,212	66,675	51,30	29	NTN	
CRO-4817LL	240,000	338,000	340,000			94,40	32	NTN	
4T-48190	107,950		34,925			1,59	29	NTN	
4T-48190/48120	107,950	161,925	34,925	26,988	34,925	2,37	29	NTN	
4T-482	69,850		29,007			0,80	29	NTN	
4T-482/472	69,850	120,000	29,007	24,237	29,794	1,33	29	NTN	
4T-482/472A	69,850	120,000	29,007	23,444	29,007	1,50	29	NTN	
NA482/472D	69,850	120,000	65,090			2,73	30	NTN	
4T-482/472D+A	69,850	120,000	65,090			2,85	30	NTN	
4T-482/472X	69,850	123,825	29,007	24,605	30,162	1,50	29	NTN	
4T-48220		182,562		33,338		1,20	29	NTN	
4T-48286	123,825		38,100			2,38	29	NTN	
4T-48286/48220	123,825	182,562	38,100	33,338	39,688	3,52	29	NTN	
4T-48290	127,000		38,100			2,10	29	NTN	
4T-48290/48220	127,000	182,562	38,100	33,338	39,688	3,33	29	NTN	
T-48290D/48220/48220D	127,000	182,562	158,750			14,30	32	NTN	
T-E-48290D/48220/48220D	130,000	182,562	158,750			14,30	32	NTN	
4T-NA48290SW/48220D	127,000	182,562	93,660			8,49	30	NTN	
4T-NA48291/48220D	127,000	182,562	85,725			7,77	30	NTN	
4T-483	63,500		29,007			0,98	29	NTN	
4T-483/472	63,500	120,000	29,007	24,237	29,794	1,48	29	NTN	
4T-48320		190,500		33,338		1,16	29	NTN	
CRO-4834	240,000	360,000	194,000			67,10	32	NTN	





Reference						Kg	?	Brands
	d	D	B	C	T			
E-LL483448/LL483418	759,925	889,000	69,850	50,800	69,850	70,50	29	NTN
4T-48385	133,350		39,688			2,47	29	NTN
4T-48385/48320	133,350	190,500	39,688	33,338	39,688	3,64	29	NTN
4T-NA48390/48320D	136,525	190,500	85,725			7,23	30	NTN
4T-48393	136,525		39,688			2,26	29	NTN
4T-48393/48320	136,525	190,500	39,688	33,338	39,688	3,43	29	NTN
4T-48393/48320D+A	136,525	190,500	85,725			7,40	30	NTN
T-48393D/48320/48320D	136,525	190,500	161,925			14,80	32	NTN
T-E-48393D/48320/48320D	139,700	190,500	161,925			14,80	32	NTN
4T-484	70,000		29,007			0,84	29	NTN
4T-484/472	70,000	120,000	29,007	24,237	29,794	1,31	29	NTN
4T-LM48510		65,088		13,970		0,08	29	NTN
4T-LM48510XL		65,088		18,034		0,10	29	NTN
4T-LM48548	34,925		18,288			0,16	29	NTN
4T-LM48548/LM48510	34,925	65,088	18,288	13,970	18,034	0,25	29	NTN
4T-LM48548A	34,925		18,288			0,16	29	NTN
4T-LM48548A/LM48510	34,925	65,088	18,288	13,970	18,288	0,25	29	NTN
4T-LM48548L	34,925		18,288			0,16	29	NTN
4T-LM48548L/LM48510	34,925	65,088	18,288	13,970	18,821	0,26	29	NTN
4T-LM48549	34,925		18,288			0,17	29	NTN
4T-LM48549X	34,925		18,288			0,16	29	NTN
4T-48620		200,025		34,130		1,39	29	NTN
T-48680D/48620/48620D	139,700	200,025	157,165			17,30	32	NTN
T-E-48680D/48620/48620D	140,000	200,025	157,165			17,30	32	NTN
4T-48684	142,875		39,688			2,46	29	NTN
4T-48684/48620	142,875	200,025	39,688	34,130	41,275	3,85	29	NTN
4T-48685	142,875		39,688			2,50	29	NTN
4T-48685/48620	142,875	200,025	39,688	34,130	41,275	3,89	29	NTN
4T-48685/48620DC+A	142,875	200,025	87,315			8,18	30	NTN
4T-NA48685SW/48620D	142,875	200,025	93,665			1,20	30	NTN
CRO-4901	245,000	380,000	255,500			106,70	32	NTN
CRO-4906LL	245,000	345,000	310,000			90,50	32	NTN
4T-49162	41,275		31,750			0,69	29	NTN
4T-49162/49368	41,275	93,662	31,750	25,400	31,750	1,05	29	NTN
4T-49175	44,450		31,750			0,64	29	NTN
4T-492A		133,350		22,225		0,42	29	NTN
4T-493		136,525		22,225		0,54	29	NTN
4T-49368		93,662		25,400		0,36	29	NTN
4T-495	82,550		29,769			1,07	29	NTN
4T-495/492A	82,550	133,350	29,769	22,225	30,162	1,49	29	NTN
4T-495/493	82,550	136,525	29,769	22,225	30,162	1,60	29	NTN
4T-495/493D+A	82,550	136,525	69,850			3,74	30	NTN
4T-49520		101,600		25,400		0,38	29	NTN
4T-49585	50,800		31,750			0,74	29	NTN
4T-49585/49520	50,800	101,600	31,750	25,400	31,750	1,13	29	NTN
4T-495A	76,200		29,769			1,24	29	NTN
4T-495A/493	76,200	136,525	29,769	22,225	30,162	1,80	29	NTN
4T-495A/493D+A	76,200	136,525	69,850			4,15	30	NTN
4T-495AS/493	77,788	136,525	29,769	22,225	30,162	1,78	29	NTN
4T-495AX	76,200		29,769			1,24	29	NTN
4T-495AX/493	76,200	136,525	29,769	22,225	30,162	1,78	29	NTN
4T-496	80,962		29,769			1,12	29	NTN





Reference	D		B	C	T	Kg	Brands	
	d	D	B	C	T			
4T-496/493	80,962	136,525	29,769	22,225	30,162	1,66	29	NTN
4T-496/493DC+A	80,962	136,525	69,850			3,89	30	NTN
4T-497	85,725		29,769			0,97	29	NTN
4T-497/492A	85,725	133,350	29,769	22,225	30,162	1,43	29	NTN
4T-497/493	85,725	136,525	29,769	22,225	30,162	1,50	29	NTN
4T-497A	85,725		29,769			0,95	29	NTN
NA497SW/K326071	85,725	184,150	73,025			8,53	30	NTN
4T-498	84,138		29,769			1,02	29	NTN
4T-498/492A	84,138	133,350	29,769	22,225	30,162	1,45	29	NTN
4T-498/493	84,138	136,525	29,769	22,225	30,162	1,60	29	NTN
4T-499A	84,975		29,769			0,99	29	NTN
4T-4A/6	19,050	44,450	11,908	9,525	12,700	0,09	29	NTN
CRO-5001	250,000	370,000	220,000			87,00	32	NTN
E-CRO-5001	250,000	370,000	220,000			87,00	32	NTN
CRI-5004	250,000	380,000	98,000			35,30	30	NTN
CRO-5004	250,000	365,000	270,000			82,10	32	NTN
E-CRO-5004	250,000	365,000	270,000			82,10	32	NTN
CR-5009	250,000	310,000	32,000	24,500	32,000	5,11	29	NTN
E-CRTD5010	250,000	380,000	100,000			40,00	37	NTN
CRO-5012	250,000	365,000	270,000			96,70	32	NTN
4T-LM501310		73,431		14,732		0,11	29	NTN
4T-LM501311		73,431		18,186		0,14	29	NTN
4T-LM501314		73,431		16,604		0,13	29	NTN
4T-LM501349	41,275		19,812			0,22	29	NTN
4T-LM501349/LM501310	41,275	73,431	19,812	14,732	19,558	0,34	29	NTN
4T-LM501349/LM501311	41,275	73,431	19,812	18,186	23,012	0,37	29	NTN
4T-LM501349/LM501314	41,275	73,431	19,812	16,604	21,430	0,35	29	NTN
4T-LM501349A/LM501310	41,275	73,431	19,812	14,732	19,558	0,34	29	NTN
CRO-5015LL	250,000	365,000	270,000			90,00	32	NTN
4T-LM503310		75,000		14,000		0,09	29	NTN
4T-LM503349	46,000		18,000			0,20	29	NTN
4T-LM503349/LM503310	46,000	75,000	18,000	14,000	18,000	0,29	29	NTN
4T-LM503349A	46,000		18,000			0,20	29	NTN
4T-LM503349A/LM503310	46,000	75,000	18,000	14,000	18,000	0,29	29	NTN
4T-HH506310		114,300		36,068		0,83	29	NTN
4T-HH506348	49,212		44,450			1,47	29	NTN
4T-HH506348/HH506310	49,212	114,300	44,450	36,068	44,450	2,33	29	NTN
4T-JLM506810		90,000		18,500		0,18	29	NTN
4T-JLM506811		90,000		20,500		0,21	29	NTN
4T-JLM506848	55,000		26,000			0,38	29	NTN
4T-JLM506849	55,000		23,000			0,36	29	NTN
4T-JLM506849/JLM506810	55,000	90,000	23,000	18,500	23,000	0,55	29	NTN
4T-JLM506849A	55,000		23,000			0,36	29	NTN
4T-JLM506849A/JLM506810	55,000	90,000	23,000	18,500	23,000	0,55	29	NTN
4T-JLM506849A/JLM506811	55,000	90,000	23,000	20,500	25,000	0,58	29	NTN
4T-JLM508710		95,000		19,000		0,19	29	NTN
4T-JLM508748	60,000		24,000			0,40	29	NTN
4T-JLM508748/JLM508710	60,000	95,000	24,000	19,000	24,000	0,60	29	NTN
CRD-5102	254,000	585,000	260,000			392,00	31	NTN
E-CRT5103	254,000	539,750	117,475			140,00	37	NTN
CRD-5116LL	254,000	358,775	269,875			81,70	32	NTN
CRD-5117LL	254,000	358,775	269,875			83,00	32	NTN

Reference						Kg	?	Brands
	d	D	B	C	T			
4T-JM511910		110,000		22,500		0,34	29	NTN
4T-JM511945	65,000		30,000			0,76	29	NTN
4T-JM511946	65,000		28,000			0,75	29	NTN
4T-JM511946/JM511910	65,000	110,000	28,000	22,500	28,000	1,09	29	NTN
4T-M514546	73,025		39,370			0,97	29	NTN
4T-JM515610		130,000		28,500		0,57	29	NTN
4T-JM515649	80,000		34,000			1,14	29	NTN
4T-JM515649/JM515610	80,000	130,000	34,000	28,500	35,000	1,72	29	NTN
4T-HM515716		142,138		33,338		1,07	29	NTN
4T-HM515745	76,200		46,100			1,84	29	NTN
4T-HM515745/HM515716	76,200	142,138	46,100	33,338	44,450	2,91	29	NTN
4T-HM516410		133,350		32,545		0,76	29	NTN
4T-HM516442/HM516410	76,200	133,350	39,688	32,545	39,688	2,43	29	NTN
4T-HM516448	82,550		39,688			1,39	29	NTN
4T-HM516448/HM516410	82,550	133,350	39,688	32,545	39,688	2,16	29	NTN
4T-HM516449	82,550		39,688			1,39	29	NTN
4T-HM516449/HM516410	82,550	133,350	39,688	32,545	39,688	2,15	29	NTN
4T-JHM516810		140,000		31,500		0,76	29	NTN
4T-JHM516849	85,000		38,000			1,52	29	NTN
4T-JHM516849/JHM516810	85,000	140,000	38,000	31,500	39,000	2,28	29	NTN
4T-HM518410		152,400		30,162		0,76	29	NTN
4T-HM518445	88,900		39,688			2,10	29	NTN
4T-HM518445/HM518410	88,900	152,400	39,688	30,162	39,688	2,86	29	NTN
CR-5201	260,000	360,000	40,000	34,000	45,000	11,40	29	NTN
CRD-5212	260,000	400,000	150,000			74,60	31	NTN
CRD-5214	260,000	458,000	155,000			109,00	31	NTN
CRD-5215	259,500	481,000	250,000			202,00	31	NTN
CRI-5215	260,000	530,000	275,000			248,00	30	NTN
CRO-5215	260,000	400,000	255,000			106,00	32	NTN
E-CRO-5215	260,000	400,000	255,000			106,00	32	NTN
CRD-5216	260,000	459,000	155,000			110,00	31	NTN
CRD-5217	260,350	419,100	180,000			95,70	31	NTN
CRI-5218	260,000	400,000	185,000			79,00	30	NTN
CRO-5218	260,000	360,000	272,000			74,20	32	NTN
4T-522		101,600		26,988		0,41	29	NTN
EE522126D/523087/523088D	539,750	784,225	339,725			552,00	32	NTN
CRD-5222	259,500	481,000	250,000			180,00	31	NTN
CR1-5224	260,000	440,000	172,000			98,90	30	NTN
CRD-5224	260,000	459,000	155,000			110,00	31	NTN
CRI-5224	260,000	440,000	172,000			99,00	30	NTN
CRO-5224LL	260,000	365,000	339,000			103,00	32	NTN
4T-LM522510		159,987		26,988		0,78	29	NTN
4T-LM522546/LM522510	107,950	159,987	34,925	26,988	34,925	2,37	29	NTN
4T-LM522548	109,987		34,925			1,46	29	NTN
4T-LM522548/LM522510	109,987	159,987	34,925	26,988	34,925	2,24	29	NTN
4T-LM522549	109,987		34,925			1,49	29	NTN
4T-LM522549/LM522510	109,987	159,987	34,925	26,988	34,925	2,27	29	NTN
CRD-5226	260,000	389,500	105,000			41,90	31	NTN
4T-JHM522610		180,000		38,000		1,51	29	NTN
4T-JHM522649	110,000		46,000			3,10	29	NTN
4T-JHM522649/JHM522610	110,000	180,000	46,000	38,000	47,000	4,61	29	NTN
CRO-5227LL	260,350	422,275	314,325			177,00	32	NTN





Reference	d		D		B	C	T	Kg	Brands
	d	D	B	C	T				
CRD-5228	260,000	445,000	180,000				111,00	31	NTN
E-CRD-5232	258,500	365,000	361,000				116,00	31	NTN
E-CRD-5232LD2	258,500	365,000	361,000				116,00	31	NTN
4T-52375	95,250		36,116				2,70	29	NTN
4T-52375/52618	95,250	157,162	36,116	26,195	36,512		2,76	29	NTN
4T-NA52375/52637D	95,250	161,925	82,547				6,60	30	NTN
4T-52387	98,425		36,116				1,92	29	NTN
4T-52387/52618	98,425	157,162	36,116	26,195	36,512		2,62	29	NTN
4T-52393	100,012		36,116				1,85	29	NTN
4T-52393/52618	100,012	157,162	36,116	26,195	36,512		2,55	29	NTN
4T-52393/52637D+A	100,012	161,925	82,547				6,25	30	NTN
4T-52400	101,600		36,116				1,78	29	NTN
4T-52400/52618	101,600	157,162	36,116	26,195	36,512		2,48	29	NTN
4T-52400D/52618+A	101,600	157,162	80,167				5,56	31	NTN
4T-52401	101,600		36,116				1,75	29	NTN
4T-52401/52618	101,600	157,162	36,116	26,195	36,512		2,45	29	NTN
4T-525	38,100		36,068				1,01	29	NTN
4T-526	41,275		36,068				1,01	29	NTN
4T-526/522	41,275	101,600	36,068	26,988	36,068		1,42	29	NTN
EE526130/526190	330,200	482,600	80,167	60,325	85,725		47,30	29	NTN
EE526130/526191D+A	330,200	482,600	177,800				96,30	30	NTN
EE526131D/526190/526191D	330,200	482,600	306,388				197,00	32	NTN
E-EE526131D/526190/526191D	330,200	482,600	306,388				197,00	32	NTN
4T-52618		157,162		26,195			0,70	29	NTN
4T-527	44,450		36,068				0,95	29	NTN
4T-527/522	44,450	101,600	36,068	26,988	36,068		1,36	29	NTN
4T-528	47,625		36,068				0,89	29	NTN
4T-528/522	47,625	101,600	36,068	26,988	36,068		1,29	29	NTN
4T-529	50,800		36,068				0,82	29	NTN
4T-529/522	50,800	101,600	36,068	26,988	36,068		1,23	29	NTN
EE529091D/529157+A	228,600	400,050	139,700				74,20	31	NTN
4T-529X	50,800		36,068				0,81	29	NTN
4T-529X/522	50,800	101,600	36,068	26,988	36,068		1,22	29	NTN
CRO-5305	266,700	355,600	230,188				62,30	32	NTN
EE531201D/531300/531301XD62	508,000	762,000	463,550				740,00	32	NTN
4T-53162	41,275		28,300				0,61	29	NTN
4T-53162/53375	41,275	95,250	28,300	20,638	30,958		0,98	29	NTN
4T-53176	44,450		28,300				0,56	29	NTN
4T-53176/53375	44,450	95,250	28,300	20,638	30,958		0,93	29	NTN
4T-53177	44,450		28,300				0,56	29	NTN
4T-53177/53375	44,450	95,250	28,300	20,638	30,958		0,92	29	NTN
4T-53178	44,450		28,300				0,56	29	NTN
4T-53178/53375	44,450	95,250	28,300	20,638	30,958		0,93	29	NTN
4T-532A		111,125		30,162			0,74	29	NTN
4T-532X		107,950		28,575			0,57	29	NTN
4T-5335		103,188		36,512			0,63	29	NTN
4T-53375		95,250		20,638			0,37	29	NTN
4T-53377		95,250		20,638			0,36	29	NTN
4T-JHM534110		230,000		31,000			1,30	29	NTN
4T-JHM534149	170,000		38,000				3,07	29	NTN
4T-JHM534149/JHM534110	170,000	230,000	38,000	31,000	39,000		4,37	29	NTN
4T-535	44,450		36,957				1,10	29	NTN

Reference						Kg	?	Brands
	d	D	B	C	T			
4T-535/532A	44,450	111,125	36,957	30,162	38,100	1,84	29	NTN
4T-536	47,625		36,957			1,04	29	NTN
4T-536/532X	47,625	107,950	36,957	28,575	36,957	1,61	29	NTN
4T-537/532X	50,800	107,950	36,957	28,575	36,957	1,53	29	NTN
4T-539	53,975		36,957			0,89	29	NTN
4T-539/532X	53,975	107,950	36,957	28,575	36,512	1,47	29	NTN
4T-5395	49,212		44,475			1,11	29	NTN
4T-5395/5335	49,212	103,188	44,475	36,512	43,658	1,75	29	NTN
4T-L540049/L540010	196,850	254,000	27,783	21,433	28,575	5,95	29	NTN
CRD-5403	270,000	395,000	94,000			38,50	31	NTN
CRO-5403	270,000	410,000	222,000			91,00	32	NTN
E-CRO-5403	270,000	410,000	222,000			91,00	32	NTN
EE542220/542290	558,800	736,600	76,200	50,800	76,200	76,70	29	NTN
EE542220/542291D+A	558,800	736,600	165,100			166,00	30	NTN
T-HM542948/HM542911	203,200	346,075	80,962	60,325	79,375	28,80	29	NTN
4T-543/532X	40,000	107,950	36,957	28,575	36,957	1,76	29	NTN
543085/543114	215,900	290,010	31,750	22,225	31,750	5,20	29	NTN
543085/543115D+A	215,900	287,338	69,850			11,00	30	NTN
4T-543114		290,010		22,225		1,73	29	NTN
544090/544118	228,600	300,038	31,750	23,812	33,338	5,61	29	NTN
T-544090/544118	228,600	300,038	31,750	23,812	33,338	6,05	29	NTN
544090/544118DF	228,600	300,038	66,676			11,10	30	NTN
T-544091/544118	231,775	300,038	31,750	23,812	33,338	5,81	29	NTN
545112/545141A	285,750	358,775	31,750	22,225	33,338	7,54	29	NTN
545112/545142D+A	285,750	358,775	76,200			15,17	30	NTN
LM545849/LM545810	234,950	314,325	49,212	36,512	49,212	9,38	29	NTN
T-LM545849/LM545810	234,950	314,325	49,212	36,512	49,212	9,38	29	NTN
E-EE547341D/547480/547481DG2	863,600	1 219,200	876,300			3 640,00	32	NTN
EE547341D/547480/547481DG2 (CRO-17301)	863,600	1 219,200	876,300			3 640,00	32	NTN
EE547341D/547480G2+A	863,600	1 219,200	425,450			1 552,00	31	NTN
CR-5501	276,225	352,425	40,000	29,000	40,000	8,76	29	NTN
CRO-5501	275,000	385,000	200,000			62,50	32	NTN
E-CRO-5501	275,000	385,000	200,000			62,50	32	NTN
4T-55175C	44,450		26,909			0,93	29	NTN
4T-55175C/55437	44,450	111,125	26,909	20,638	30,162	1,45	29	NTN
4T-55176	44,450		26,909			0,85	29	NTN
4T-55176/55437	44,450	111,125	26,909	20,638	30,162	1,35	29	NTN
4T-55176/55443	44,450	112,712	26,909	20,638	30,162	1,40	29	NTN
4T-55176C/55437	44,450	111,125	26,909	20,638	30,162	1,09	29	NTN
4T-55187	47,625		26,909			0,80	29	NTN
4T-55187/55437	47,625	111,125	26,909	20,638	30,162	1,31	29	NTN
4T-55187/55443	47,625	112,712	26,909	20,638	30,162	1,35	29	NTN
4T-55187C	47,625		26,909			0,88	29	NTN
4T-55187C/55437	47,625	111,125	26,909	20,638	30,162	1,40	29	NTN
4T-55187C/55443	47,625	112,712	26,909	20,638	30,162	1,43	29	NTN
4T-552		123,825		33,338		0,80	29	NTN
4T-55200C	50,800		26,909			0,84	29	NTN
4T-55200C/55437	50,800	111,125	26,909	20,638	30,162	1,33	29	NTN
4T-55200C/55443	50,800	112,712	26,909	20,638	30,162	1,34	29	NTN
4T-55206/55444D+A	52,388	112,712	65,088			2,78	30	NTN
4T-552A		123,825		30,162		0,75	29	NTN
4T-5535		122,238		36,512		0,80	29	NTN





Reference						Kg	?	Brands
	d	D	B	C	T			
4T-553X		122,238		30,162		0,68	29	NTN
4T-55437		111,125		20,638		0,51	29	NTN
4T-55443		112,712		20,638		0,55	29	NTN
4T-555/552A	50,800	123,825	36,678	30,162	38,100	2,34	29	NTN
L555233/L555210	279,400	374,650	47,625	34,925	47,625	13,00	29	NTN
L555233/L555210D+A	279,400	374,650	104,775			28,50	30	NTN
E-L555249/L555210	292,100	374,650	47,625	34,925	47,625	11,90	29	NTN
L555249/L555210	292,100	374,650	47,625	34,925	47,625	11,50	29	NTN
L555249/L555210D+A	292,100	374,650	104,775			25,20	30	NTN
4T-555S	57,150		36,678			1,41	29	NTN
4T-555S/552A	57,150	123,825	36,678	30,162	38,100	2,18	29	NTN
4T-5565	50,800		43,764			1,82	29	NTN
4T-5578	53,975		43,764			1,81	29	NTN
4T-5578/5535	53,975	122,238	43,764	36,512	43,658	2,64	29	NTN
4T-557S	53,975		36,678			1,50	29	NTN
4T-557S/552A	53,975	123,825	36,678	30,162	38,100	2,26	29	NTN
4T-558/552A	60,325	123,825	36,678	30,162	38,100	2,10	29	NTN
4T-NA558/552D	60,325	123,825	79,375			3,31	30	NTN
4T-5583	60,325		43,764			1,61	29	NTN
4T-5583/5535	60,325	122,238	43,764	36,512	43,658	2,44	29	NTN
4T-5584/5535	63,500	122,238	43,764	36,512	43,764	2,31	29	NTN
4T-559	63,500		36,678			1,23	29	NTN
4T-559/552	63,500	123,825	36,678	33,338	38,100	2,03	29	NTN
4T-559/552A	63,500	123,825	36,678	30,162	38,100	2,01	29	NTN
4T-560	66,675		36,678			1,15	29	NTN
4T-560/552	66,675	123,825	36,678	33,338	38,100	1,95	29	NTN
4T-560/552A	66,675	123,825	36,678	30,162	38,100	1,92	29	NTN
4T-560S	68,262		36,678			1,10	29	NTN
4T-560S/552A	68,262	123,825	36,678	30,162	38,100	1,86	29	NTN
CRD-5613	279,400	533,400	241,300			272,00	31	NTN
CRT5613	279,400	603,250	136,525			172,00	37	NTN
CRO-5614	279,400	419,100	292,100			141,00	32	NTN
CRI-5615	280,000	400,000	150,000			53,80	30	NTN
CRD-5616	280,000	410,000	110,000			49,00	31	NTN
E-CRD-5616	280,000	410,000	110,000			45,20	31	NTN
E-CRT5617	279,400	603,250	136,525			205,00	37	NTN
E-CRD-5621	280,000	380,000	92,000			28,90	31	NTN
LL562749/LL562710	361,950	406,400	23,812	17,462	23,812	3,56	29	NTN
CRO-5628	279,400	381,000	269,875			79,60	32	NTN
4T-563		127,000		28,575		0,64	29	NTN
CRO-5639LL	280,000	410,000	268,000			116,00	32	NTN
4T-56418	106,362		36,512			1,89	29	NTN
4T-56418/56650	106,362	165,100	36,512	26,988	36,512	2,76	29	NTN
4T-56425	107,950		36,512			1,82	29	NTN
4T-56425/56650	107,950	165,100	36,512	26,988	36,512	2,69	29	NTN
4T-56425/56650D+A	107,950	165,100	82,550			5,90	30	NTN
4T-56425/56662	107,950	168,275	36,152	26,988	36,512	2,80	29	NTN
4T-NA56425SW/56650D	107,975	165,125	89,154			6,61	30	NTN
4T-56426	107,950		36,512			1,84	29	NTN
4T-56426/56650	107,950	165,100	36,512	26,988	36,512	2,60	29	NTN
4T-565	63,500		36,170			1,44	29	NTN
4T-565/563	63,500	127,000	36,170	28,575	36,512	2,11	29	NTN

Reference						Kg	?	Brands
	d	D	B	C	T			
CRO-5650 (CRO-5676)	280,000	380,000	290,000			105,00	32	NTN
CRO-5652LL	279,400	393,700	269,875			96,40	32	NTN
LM565943/LM565910	374,650	522,288	84,138	61,912	85,725	54,50	29	NTN
LM565949/LM565910	381,000	522,288	84,138	61,912	85,725	52,50	29	NTN
LM565949/LM565912	381,000	523,875	84,138	61,912	85,725	53,20	29	NTN
4T-566	69,850		36,170			1,24	29	NTN
4T-566/563	69,850	127,000	36,170	28,575	36,512	1,92	29	NTN
CRO-5660LL	280,000	380,000	290,000			90,00	32	NTN
CRO-5664LL	280,000	395,000	340,000			126,00	32	NTN
4T-56650		165,100		26,988		0,84	29	NTN
CRO-5665LL	280,000	395,000	290,000			108,00	32	NTN
4T-56662		168,275		26,988		1,04	29	NTN
LL566848/LL566810	403,225	460,375	28,575	20,638	28,575	6,60	29	NTN
4T-567	73,025		36,170			1,16	29	NTN
4T-567/563	73,025	127,000	36,170	28,575	36,512	1,82	29	NTN
4T-NA567/563D	73,025	127,000	80,962			3,85	30	NTN
LM567943/LM567910B	396,875	549,275	84,138	61,912	84,138	61,45	29	NTN
LM567949/LM567910	406,400	549,275	84,138	61,912	85,725	56,20	29	NTN
4T-567A/563	71,438	127,000	36,170	28,575	36,512	1,87	29	NTN
4T-568	73,817		36,170			1,13	29	NTN
4T-568/563	73,817	127,000	36,170	28,575	36,512	1,80	29	NTN
CRD-5704	285,000	380,000	92,000			29,00	31	NTN
L570649/L570610	457,200	573,088	74,612	57,150	74,612	42,50	29	NTN
CRO-5709LL	285,000	400,000	340,000			134,00	32	NTN
EE571602/572651D+A	406,400	673,100	192,639			245,00	30	NTN
EE571703/572650	431,800	673,100	87,833	60,325	88,900	114,00	29	NTN
EE571703/572651D+A	431,800	673,100	192,639			225,00	30	NTN
4T-572		139,992		28,575		0,78	29	NTN
4T-572X		139,700		28,575		0,76	29	NTN
4T-575	76,200		36,098			1,64	29	NTN
4T-575/572	76,200	139,992	36,098	28,575	36,512	2,43	29	NTN
4T-575/572X	76,200	139,700	36,098	28,575	36,098	2,40	29	NTN
LL575343/LL575310	533,400	635,000	50,800	38,100	50,800	26,40	29	NTN
LL575349/LL575310	539,750	635,000	50,800	38,100	50,800	24,90	29	NTN
4T-575S/572	76,200	139,992	36,098	28,575	36,512	2,41	29	NTN
4T-576/572	73,025	139,992	36,098	28,575	36,512	2,53	29	NTN
4T-5760/5735	76,200	135,733	46,100	34,925	44,450	2,75	29	NTN
4T-577/572	74,612	139,992	36,098	28,575	36,512	2,48	29	NTN
4T-578/572D+A	79,985	139,992	82,550			4,79	30	NTN
4T-578/572DC+A	79,985	139,992	82,550			5,13	30	NTN
4T-580	82,550		36,098			1,41	29	NTN
4T-580/572	82,550	139,992	36,098	28,575	36,512	2,20	29	NTN
4T-580/572D	82,550	139,992	82,550			4,56	30	NTN
4T-580/572X	82,550	139,700	36,098	28,575	36,512	2,18	29	NTN
E-CRTD5807	291,150	520,000	266,000			239,00	37	NTN
CRI-5808	290,000	400,000	120,000			40,00	30	NTN
4T-581	80,962		36,098			1,40	29	NTN
4T-581/572	80,962	139,992	36,098	28,575	36,512	2,26	29	NTN
CR1-5810	290,000	430,000	150,000			72,10	30	NTN
CRI-5810	290,000	430,000	150,000			72,70	30	NTN
4T-CR-5812	288,925	406,400	77,788	60,325	77,788	30,20	29	NTN
CRO-5814LL	290,000	400,000	346,000			129,00	32	NTN





Reference	d		B	C	T	Kg	Brands	
	d	D	B	C	T			
4T-582	82,550		36,098			1,39	29	NTN
4T-582/572	82,550	139,992	36,098	28,575	36,512	2,19	29	NTN
4T-582/572D+A	82,550	139,992	82,550			4,64	30	NTN
4T-59162	41,275		36,512			1,15	29	NTN
4T-59162/59412	41,275	104,775	36,512	28,575	36,512	1,62	29	NTN
4T-59175	44,450		36,512			1,09	29	NTN
4T-59175/59412	44,450	104,775	36,512	28,575	36,512	1,56	29	NTN
4T-592		152,400		33,338		1,04	29	NTN
4T-59200	50,800		36,512			0,95	29	NTN
4T-59200/59412	57,150	97,630	36,512	28,575	24,608	1,42	29	NTN
4T-592A		152,400		30,162		1,04	29	NTN
4T-593	88,900		36,322			0,76	29	NTN
4T-593/592A	88,900	152,400	36,322	30,162	39,688	2,77	29	NTN
NA593/592D	88,900	152,400	82,550			5,56	30	NTN
4T-593/592D+A	88,900	152,400	82,550			5,76	30	NTN
4T-593A	88,900		36,322			1,70	29	NTN
4T-593X		150,000		27,000		0,76	29	NTN
4T-594	95,250		36,322			1,44	29	NTN
4T-594/592	95,250	152,400	36,322	33,338	39,688	2,56	29	NTN
4T-594/592A	95,250	152,400	36,322	30,162	39,688	2,51	29	NTN
4T-594/592D+A	95,250	152,400	82,550			5,68	30	NTN
4T-594/593X	95,250	150,000	36,322	27,000	36,322	2,20	29	NTN
4T-59412		104,775		28,575		0,47	29	NTN
4T-594A	95,250		36,322			1,44	29	NTN
4T-594A/592A	95,250	152,400	36,322	30,162	39,688	2,50	29	NTN
4T-594A/592XE	95,250	147,638	36,322	26,192	35,717	2,09	29	NTN
4T-595	82,550		36,322			1,96	29	NTN
4T-595/592A	82,550	152,400	36,322	30,162	39,688	3,02	29	NTN
4T-596	85,725		36,322			1,84	29	NTN
4T-596/592A	85,725	152,400	36,322	30,162	39,688	2,90	29	NTN
4T-596S/592DC+A	87,312	152,400	82,550			5,41	30	NTN
4T-598	92,075		36,322			1,59	29	NTN
4T-598/592A	92,075	152,400	36,322	30,162	39,688	2,65	29	NTN
4T-598A	92,075		36,322			1,54	29	NTN
4T-598A/592A	92,075	152,400	36,322	30,162	39,688	2,63	29	NTN
4T-598A/593X	92,075	150,000	36,322	27,000	35,992	2,32	29	NTN
CRD-6006	300,000	500,000	180,000			143,00	31	NTN
CRI-6010	300,000	540,000	208,000			184,00	30	NTN
CRO-6012	300,000	470,000	270,000			152,00	32	NTN
E-CRO-6012	300,000	470,000	270,000			152,00	32	NTN
4T-CR-6013	300,000	460,000	100,000	76,000	100,000	58,20	29	NTN
E-CRO-6013	300,000	470,000	292,000			164,00	32	NTN
CRO-6013 (CRO-6033)	300,000	470,000	292,000			164,00	32	NTN
CRO-6015	300,000	460,000	360,000			180,00	32	NTN
E-CRO-6015	300,000	460,000	360,000			180,00	32	NTN
CR-6016	300,000	380,000	38,000	28,000	38,000	9,44	29	NTN
CRO-6019	300,000	430,000	280,000			132,00	32	NTN
CRO-6022	300,000	430,000	300,000			141,00	32	NTN
CRD-6025	300,000	440,000	105,000			54,00	31	NTN
CRD-6026	300,000	520,000	180,000			187,00	31	NTN
CRD-6027	300,000	440,000	105,000			54,00	31	NTN
CR-6027DB	300,000	420,000	420,000			163,00	30	NTN

Reference						Kg		Brands
	d	D	B	C	T			
CRD-6028	300,000	500,000	200,000			158,00	31	NTN
E-CRD-6028	300,000	500,000	200,000			158,00	31	NTN
CRD-6030	300,000	500,000	200,000			158,00	31	NTN
4T-LM603011		77,788		15,080		0,12	29	NTN
4T-LM603012		77,788		16,667		0,14	29	NTN
4T-JLM603013Z		78,000		15,000		0,12	29	NTN
4T-LM603014		80,000		15,080		0,15	29	NTN
4T-JLM603048	45,000		23,950			0,25	29	NTN
4T-LM603049	45,242		19,842			0,25	29	NTN
4T-LM603049/LM603011	45,242	77,788	19,842	15,080	19,842	0,37	29	NTN
4T-LM603049/LM603012	45,242	77,788	19,842	16,667	21,430	0,39	29	NTN
4T-LM603049/LM603014	45,242	80,000	19,842	15,080	19,842	0,39	29	NTN
4T-LM603049JX	45,242		19,842			0,24	29	NTN
CRO-6031LL	300,000	430,000	295,000			136,00	32	NTN
CRO-6038LL	300,000	400,000	254,000			84,60	32	NTN
CRO-6042LL	300,000	420,000	310,000			128,00	32	NTN
4T-A6067	16,993		11,153			0,04	29	NTN
4T-A6075	19,050		11,153			0,03	29	NTN
4T-A6075/A6157	19,050	39,992	11,153	9,525	12,014	0,07	29	NTN
CRD-6101	305,079	500,000	200,000			155,00	31	NTN
CRD-6104	305,105	559,867	169,977			217,00	31	NTN
4T-L610510		94,458		15,083		0,16	29	NTN
4T-L610549	63,500		19,050			0,29	29	NTN
4T-L610549/L610510	63,500	94,458	19,050	15,083	19,050	0,45	29	NTN
CRI-6108	305,000	560,000	223,000			227,00	30	NTN
CRD-6109	304,800	499,948	158,750			158,00	31	NTN
CRD-6110	305,105	559,968	200,000			217,00	31	NTN
E-CRD-6111K	304,271	447,675	158,750			84,26	31	NTN
CRD-6112	305,069	559,999	200,000			218,00	31	NTN
CRD-6113	305,003	559,867	169,977			192,00	31	NTN
CRD-6115	305,105	599,968	170,434			169,00	31	NTN
CRD-6116	305,079	500,000	200,000			155,00	31	NTN
CRD-6117	305,105	559,867	169,977			217,00	31	NTN
4T-612		120,650		31,750		0,85	29	NTN
CRD-6120	305,000	500,000	200,000			135,00	31	NTN
CRD-6123	304,800	499,948	200,000			155,00	31	NTN
CRD-6125	305,079	500,000	200,000			155,00	31	NTN
4T-JM612910		115,000		23,000		0,36	29	NTN
4T-JM612949	70,000		29,000			0,75	29	NTN
4T-JM612949/JM612910	70,000	115,000	29,000	23,000	29,000	1,11	29	NTN
CRD-6132	304,648	438,048	128,575			62,80	31	NTN
CRD-6135	305,000	560,000	200,000			218,00	31	NTN
CRD-6136	305,069	560,000	200,000			218,00	31	NTN
CRD-6137	305,000	500,000	200,000			155,00	31	NTN
CRD-6140	305,000	559,968	169,977			193,00	31	NTN
E-E61400/161901DC+A	355,600	482,600	133,350			62,10	30	NTN
CRO-6143LL	304,648	438,048	280,990			136,00	32	NTN
CRD-6146	305,000	560,000	200,000			218,00	31	NTN
CRD-6148	305,000	500,000	200,000			155,00	31	NTN
E-CRD-6148	305,000	500,000	200,000			155,00	31	NTN
CRD-6151	305,000	500,000	200,000			155,00	31	NTN
E-CRD-6151	305,000	500,000	200,000			141,00	31	NTN





Reference	d		D		B	C	T	Kg	Brands
	d	D	B	C	T				
CRD-6152	305,069	559,999	200,000				218,00	31	NTN
CRD-6154	305,000	560,000	200,000				218,00	31	NTN
4T-A6157		39,992		9,525			0,03	29	NTN
4T-A6162		41,275		8,730			0,03	29	NTN
4T-HM617010		142,138		34,133			0,90	29	NTN
4T-HM617049	85,725		42,862				1,77	29	NTN
4T-HM617049/HM617010	85,725	142,138	42,862	34,133	42,862		2,69	29	NTN
4T-619	50,800		41,275				1,42	29	NTN
4T-619/612	50,800	120,650	41,275	31,750	41,275		2,30	29	NTN
CRO-6204	310,000	430,000	310,000				136,00	32	NTN
4T-621	53,975		41,275				1,33	29	NTN
4T-621/612	53,975	120,650	41,275	31,750	41,275		2,21	29	NTN
CRO-6213	310,000	430,000	310,000				133,00	32	NTN
E-CR1-6216	311,150	558,800	190,500				181,00	30	NTN
4T-6220		127,000		41,275			1,21	29	NTN
CRO-6220LL	310,000	430,000	310,000				133,00	32	NTN
CRO-6222LL	310,000	430,000	350,000				150,00	32	NTN
4T-623	57,150		41,275				1,24	29	NTN
4T-623/612	57,150	120,650	41,275	31,750	41,275		2,12	29	NTN
623024	120,000	180,000	100,000				8,87	32	NTN
623028	140,000	210,000	114,000				13,80	32	NTN
623034	170,000	260,000	144,000				27,50	32	NTN
623044	220,000	340,000	190,000				63,20	32	NTN
623052	260,000	400,000	220,000				98,90	32	NTN
623068	340,000	520,000	278,000				213,00	32	NTN
623076	380,000	560,000	282,000				240,00	32	NTN
623124	120,000	200,000	132,000				16,70	32	NTN
623134	170,000	280,000	185,000				45,20	32	NTN
623160	300,000	500,000	332,000				257,00	32	NTN
623160A	300,000	500,000	332,000				257,00	32	NTN
623172 (CRO-7228)	360,000	600,000	396,000				447,00	32	NTN
4T-L624510		160,338		16,670			0,40	29	NTN
4T-L624549/L624510	120,650	160,338	21,433	16,670	21,433		1,15	29	NTN
6259/500	500,000	705,000	515,000				632,00	32	NTN
E-6259/500	500,000	705,000	515,000				632,00	32	NTN
625924	120,000	170,000	124,000				8,97	32	NTN
E-625924	120,000	170,000	124,000				8,97	32	NTN
625926	130,000	184,000	134,000				11,30	32	NTN
E-625926	135,000	184,000	134,000				11,30	32	NTN
625928	140,000	198,000	144,000				14,00	32	NTN
E-625928	146,050	198,000	144,000				14,00	32	NTN
625930	150,000	212,000	155,000				16,90	32	NTN
E-625930	152,400	212,000	155,000				16,90	32	NTN
625932	160,000	226,000	165,000				20,20	32	NTN
E-625932	160,000	226,000	165,000				20,20	32	NTN
625934	170,000	240,000	175,000				24,40	32	NTN
E-625934	170,000	240,000	175,000				24,40	32	NTN
625936	180,000	254,000	185,000				28,90	32	NTN
E-625936	180,000	254,000	185,000				28,90	32	NTN
625938	190,000	268,000	196,000				34,70	32	NTN
E-625938	190,000	268,000	196,000				34,70	32	NTN
625940	200,000	282,000	206,000				40,50	32	NTN

Reference						Kg	 Brands	
	d	D	B	C	T			
E-625940	200,000	282,000	206,000			40,50	32	NTN
625944	220,000	310,000	226,000			53,50	32	NTN
E-625944	220,000	310,000	226,000			53,50	32	NTN
E-625948A	240,000	338,000	248,000			70,00	32	NTN
625948A (CRO-4825)	240,000	338,000	248,000			70,00	32	NTN
625952	260,000	368,000	268,000			90,30	32	NTN
625952	260,000	368,000	268,000			90,30	32	NTN
E-625952	260,000	368,000	268,000			90,30	32	NTN
625956	280,000	395,000	288,000			109,62	32	NTN
E-625956	280,000	395,000	288,000			111,00	32	NTN
625956 (CRO-5684)	280,000	395,000	288,000			111,00	32	NTN
625960	300,000	424,000	310,000			138,00	32	NTN
E-625960	300,000	424,000	310,000			138,00	32	NTN
625964	320,000	460,000	338,000			183,00	32	NTN
E-625964	320,000	460,000	338,000			183,00	32	NTN
625968	340,000	480,000	350,000			200,00	32	NTN
E-625968	340,000	480,000	350,000			200,00	32	NTN
E-625972	360,000	508,000	370,000			236,00	32	NTN
625972 (CRO-7227)	360,000	508,000	370,000			236,00	32	NTN
625976	380,000	536,000	390,000			277,00	32	NTN
E-625976	380,000	536,000	390,000			277,00	32	NTN
625980	400,000	564,000	412,000			324,00	32	NTN
E-625980	400,000	564,000	412,000			324,00	32	NTN
E-625984	420,000	592,000	432,000			374,00	32	NTN
625984 (CRO-8414)	420,000	592,000	432,000			374,00	32	NTN
E-625988	440,000	620,000	454,000			430,00	32	NTN
625988 (CRO-8839)	440,000	620,000	454,000			430,00	32	NTN
625992A	460,000	650,000	474,000			493,00	32	NTN
E-625992A	460,000	650,000	474,000			493,00	32	NTN
625996	480,000	678,000	494,000			563,00	32	NTN
E-625996	480,000	678,000	494,000			563,00	32	NTN
EE626210/626321D+A	533,400	812,800	269,875			444,00	30	NTN
4T-6277	44,450		52,388			2,34	29	NTN
4T-6277/6220	44,450	127,000	52,388	41,275	52,388	3,60	29	NTN
4T-6280	53,975		52,388			2,03	29	NTN
4T-6280/6220	53,975	127,000	52,388	41,275	52,388	3,24	29	NTN
4T-L630349/L630310	152,400	192,088	24,000	19,000	25,000	1,53	29	NTN
4T-632		136,525		31,750		1,03	29	NTN
4T-6320		135,755		44,450		1,38	29	NTN
4T-633		130,175		31,750		0,71	29	NTN
4T-635	57,150		41,275			1,98	29	NTN
4T-6379	65,088		56,007			2,33	29	NTN
4T-6379/6320	65,088	135,755	56,007	44,450	53,975	3,71	29	NTN
4T-6386	66,675		56,007			2,26	29	NTN
4T-6386/6320	66,675	135,755	56,007	44,450	56,007	3,64	29	NTN
4T-639	63,500		41,275			1,79	29	NTN
4T-639/632	63,500	136,525	41,275	31,750	41,275	2,85	29	NTN
4T-LL639249/LL639210	196,850	241,300	23,017	17,462	23,812	2,04	29	NTN
T-EE640192/640260G2	488,950	660,400	94,458	69,850	93,662	85,20	29	NTN
T-EE640192/640261DG2+A	488,950	660,400	206,375			178,00	30	NTN
T-EE640193D/640260/640261DG2	488,950	660,400	365,125			364,00	32	NTN
T-E-EE640193D/640260/640261DG2	488,950	660,400	365,125			364,00	32	NTN





Reference	d		D		B	C	T	Kg	Brands
	d	D	B	C	T				
4T-CR-6408	320,000	480,000	100,000	76,000	100,000	58,60	29	NTN	
CRD-6409	320,000	510,800	220,000			173,00	31	NTN	
4T-641	66,675		41,275			1,68	29	NTN	
4T-641/632	66,675	136,525	41,275	31,750	41,275	2,74	29	NTN	
4T-641/633	66,675	130,175	41,275	31,750	41,275	2,41	29	NTN	
CRI-6410	320,000	550,000	240,000			223,00	30	NTN	
4T-LL641110		261,142		21,433		1,07	29	NTN	
4T-LL641149	203,200		27,783			2,41	29	NTN	
CRI-6412	317,500	558,800	254,000			248,00	30	NTN	
CRD-6415	320,000	580,000	240,000			260,00	31	NTN	
4T-6420		149,225		44,450		1,63	29	NTN	
CRD-6420	320,000	620,000	280,000			390,00	31	NTN	
CRO-6426LL	320,000	480,000	360,000			228,00	32	NTN	
4T-643	69,850		41,275			1,57	29	NTN	
4T-643/632	69,850	136,525	41,275	31,750	41,275	2,63	29	NTN	
4T-NA643/632D	69,850	136,525	95,250			5,76	30	NTN	
4T-643/632D+A	69,850	136,525	95,250			5,26	30	NTN	
4T-644	71,438		41,275			1,52	29	NTN	
4T-644/632	71,438	136,525	41,275	31,750	41,275	2,57	29	NTN	
4T-64432/64708	110,000	180,000	41,275	30,162	41,275	3,91	29	NTN	
4T-64433	109,992		41,275			2,65	29	NTN	
4T-64433/64700	109,992	177,800	41,275	30,162	41,275	3,77	29	NTN	
4T-64450	114,300		41,275			2,37	29	NTN	
4T-64450/64700	114,300	177,800	41,275	30,162	41,275	3,52	29	NTN	
4T-64450/64700CD+A	114,300	177,800	92,075			7,74	30	NTN	
4T-64450/64700D+A	114,300	177,800	92,075			7,64	30	NTN	
4T-645	71,438		41,275			1,50	29	NTN	
4T-645/632	71,438	136,525	41,275	31,750	41,275	2,52	29	NTN	
4T-6460	73,025		54,229			2,79	29	NTN	
4T-6460/6420	73,025	149,225	54,229	44,450	54,229	4,42	29	NTN	
4T-6461	76,200		54,229			2,63	29	NTN	
4T-6461/6420	76,200	149,225	54,229	44,450	54,229	4,26	29	NTN	
4T-6461A	76,200		54,229			2,60	29	NTN	
4T-6461A/6420	76,200	149,225	54,229	44,450	54,229	4,24	29	NTN	
EE649237/649311D+A	602,945	787,400	206,375			246,00	30	NTN	
E-EE649237/649311D+A	602,945	787,400	206,375			246,00	30	NTN	
E-EE649240/649310	609,600	787,400	93,662	69,850	93,662	112,00	29	NTN	
EE649240/649310G2	609,600	787,400	93,662	69,850	93,662	112,00	29	NTN	
EE649240/649311DG2+A	609,600	787,400	206,375			235,00	30	NTN	
EE649241D/649310/649311DG2	609,600	787,400	361,950			458,00	32	NTN	
E-EE649241D/649310/649311DG2	609,600	787,400	361,950			458,00	32	NTN	
T-EE649241D/649310G2+A	609,600	787,400	171,450			210,00	31	NTN	
CRO-6501	327,000	445,000	230,000			99,80	32	NTN	
4T-652		152,400		31,750		1,30	29	NTN	
4T-65200	50,800		44,450			1,83	29	NTN	
4T-65200/65500	50,800	127,000	44,450	34,925	44,450	2,85	29	NTN	
4T-65212/65500	53,975	127,000	44,450	34,925	44,450	2,79	29	NTN	
4T-65237	60,325		44,450			1,54	29	NTN	
4T-65237/65500	60,325	127,000	44,450	34,925	44,450	2,65	29	NTN	
4T-6525X		160,000		44,450		1,67	29	NTN	
4T-653		146,050		31,750		0,90	29	NTN	
4T-65320		114,300		34,925		0,87	29	NTN	

Reference						Kg	?	Brands
	d	D	B	C	T			
4T-6535		161,925		42,862		1,60	29	NTN
4T-65385	44,450		44,450			1,46	29	NTN
4T-65385/65320	44,450	114,300	44,450	34,925	44,450	2,32	29	NTN
4T-65390	49,212		44,450			1,33	29	NTN
4T-65390/65320	49,212	114,300	44,450	34,925	44,450	2,23	29	NTN
T-LM654642/LM654610	279,982	380,898	65,088	49,212	65,088	19,00	29	NTN
T-LM654642/LM654610D+A	279,982	380,898	139,700			40,70	30	NTN
T-E-LM654644D/LM654610/LM654610D	279,578	380,898	244,475			83,20	32	NTN
T-LM654644D/LM654610/LM654610D (CRO-5679)	279,578	380,898	244,475			83,20	32	NTN
T-E-LM654648D/LM654610/LM654610D	285,750	380,898	244,475			82,50	32	NTN
T-LM654648D/LM654610/LM654610D (CRO-5710)	285,750	380,898	244,475			82,50	32	NTN
T-LM654648D/LM654610+A	285,750	380,898	117,475			36,70	31	NTN
E-LM654649/LM654610CD+A	285,750	380,898	139,700			38,80	30	NTN
E-LM654649/LM654610DB	285,750	380,898	162,176			41,90	30	NTN
LM654649/LM654610DB	285,750	380,898	162,176			41,90	30	NTN
T-LM654649/LM654610	285,750	380,898	65,088	49,212	65,088	18,00	29	NTN
T-LM654649/LM654610D+A	285,750	380,898	139,700			38,70	30	NTN
4T-655	69,850		41,275			2,50	29	NTN
4T-655/653	69,850	146,050	41,275	31,750	41,275	2,50	29	NTN
4T-65500		127,000		34,925		1,02	29	NTN
EE655270/655345G2	685,800	876,300	92,075	69,850	93,662	134,00	29	NTN
E-EE655271D/655345/655346D	685,800	876,300	355,600			539,00	32	NTN
E-EE655271D/655345/655346DG2	685,800	876,300	352,425			539,00	32	NTN
EE655271D/655345/655346DG2 (CRO-13708)	685,800	876,300	352,425			539,00	32	NTN
EE655271D/655345G2+A	685,800	876,300	168,275			247,00	31	NTN
4T-6559/6535	82,550	161,925	55,100	42,862	55,100	5,06	29	NTN
4T-6559C/6535	82,550	161,925	55,100	42,862	53,975	5,09	29	NTN
4T-6575	76,200		55,100			3,74	29	NTN
4T-6575/6535	76,200	161,925	55,100	42,862	55,100	5,43	29	NTN
4T-6576	76,200		55,100			3,77	29	NTN
4T-6576/6535	76,200	161,925	55,100	42,862	55,100	5,44	29	NTN
4T-6580	88,900		55,100			3,06	29	NTN
4T-6580/6535	88,900	161,925	55,100	42,862	53,975	4,73	29	NTN
4T-6581X	90,000		55,100			1,58	29	NTN
4T-6581X/6525X	90,000	160,000	55,100	44,450	55,100	4,52	29	NTN
4T-6581X/6535	90,000	161,925	55,100	42,862	55,100	4,66	29	NTN
4T-659	76,200		41,275			2,15	29	NTN
4T-659/653	76,200	146,050	41,275	31,750	41,275	3,04	29	NTN
CRO-6602	330,000	510,000	340,000			221,00	32	NTN
E-CRO-6602	330,000	510,000	340,000			221,00	32	NTN
CRI-6603	330,000	500,000	190,000			117,00	30	NTN
CR-6604	330,000	460,000	52,000	35,000	52,000	24,80	29	NTN
CRD-6604	330,000	458,000	120,000			59,70	31	NTN
CRO-6604	330,000	470,000	340,000			141,00	32	NTN
E-CRO-6604	320,000	470,000	340,000			141,00	32	NTN
CRO-6606	330,200	533,400	254,000			221,00	32	NTN
CRD-6608	330,000	650,000	248,000			383,00	31	NTN
4T-661	79,375		41,275			2,02	29	NTN
4T-661/652	79,375	152,400	41,275	31,750	41,275	3,28	29	NTN
4T-661/653	79,375	146,050	41,275	653,000	41,275	2,91	29	NTN
4T-66200	50,800		31,750			1,11	29	NTN
4T-66200/66462	50,800	117,475	31,750	23,812	33,338	1,67	29	NTN





Reference	d		D		B	C	T	Kg	Brands
	d	D	B	C	T				
4T-66225	57,150		31,750				0,98	29	NTN
4T-66225/66462	57,150	117,475	31,750	23,812	33,338		1,54	29	NTN
4T-663	82,550		41,275				2,00	29	NTN
4T-663/652	82,550	152,400	41,275	31,750	41,275		3,15	29	NTN
4T-663/653	82,550	146,050	41,275	31,750	41,275		2,78	29	NTN
4T-664	84,138		41,275				1,82	29	NTN
4T-66462		117,475		23,812			0,54	29	NTN
4T-665	85,725		41,275				1,74	29	NTN
4T-665/652	85,725	152,400	41,275	31,750	41,275		3,02	29	NTN
4T-665/653	85,725	146,050	41,275	31,750	41,275		2,65	29	NTN
4T-66520		122,238		23,812			0,55	29	NTN
4T-66584	53,975		31,750				1,24	29	NTN
4T-66584/66520	53,975	122,238	31,750	23,812	33,338		1,79	29	NTN
4T-66589/66520	59,972	122,238	31,750	23,812	33,338		1,66	29	NTN
E-LM665949/LM665910	385,762	514,350	82,550	63,500	82,550		45,44	29	NTN
LM665949/LM665910	385,762	514,350	82,550	63,500	82,550		41,80	29	NTN
E-LM665949/LM665910CD+A	385,762	514,350	177,800				90,00	30	NTN
LM665949/LM665910D+A	385,762	514,350	177,800				90,00	30	NTN
E-LM665949D/LM665910/LM665910D	385,762	514,350	317,500				240,00	32	NTN
LM665949D/LM665910/LM665910D	385,762	514,350	317,500				240,00	32	NTN
4T-665A	85,725		41,275				1,72	29	NTN
M667935/M667911G2	387,248	546,100	87,312	68,262	87,312		56,60	29	NTN
M667947D/M667910G2+A	409,575	546,100	161,925				104,00	31	NTN
E-M667947D/M667911/M667911DG2	409,575	546,100	334,962				226,00	32	NTN
M667947D/M667911/M667911DG2	409,575	546,100	334,962				226,00	32	NTN
M667948/M667911	409,575	546,100	87,312	68,262	87,312		49,80	29	NTN
4T-LM67010		59,131		11,811			0,06	29	NTN
4T-LM67010XL		59,131		11,811			0,06	29	NTN
4T-LM67045	31,750		18,500				0,13	29	NTN
4T-LM67045/LM67010	31,750	59,131	18,500	11,811	18,500		0,19	29	NTN
4T-LM67048	31,750		16,764				0,12	29	NTN
4T-LM67048/LM67010	31,750	59,131	16,764	11,811	16,764		0,18	29	NTN
4T-LM67048L	31,750		16,764				0,12	29	NTN
4T-LM67048L/LM67010	31,750	59,131	16,764	11,811	16,764		0,18	29	NTN
4T-LM67049A	31,750		16,764				0,12	29	NTN
4T-LM67049A/LM67010	31,750	59,131	16,764	11,811	16,764		0,18	29	NTN
EE671801/672873	457,200	730,148	114,300	82,550	120,650		188,00	29	NTN
EE671801/672875D+A	457,200	730,148	254,000				360,00	30	NTN
4T-672		168,275		30,162			1,30	29	NTN
4T-67320		203,200		38,100			2,06	29	NTN
4T-67322		196,850		38,100			1,46	29	NTN
4T-67388	127,000		46,038				3,64	29	NTN
4T-67388/67322	127,000	196,850	46,038	38,100	46,038		5,10	29	NTN
4T-67388/67322D+A	127,000	196,850	101,600				10,10	30	NTN
4T-67389/67322	130,175	196,850	46,038	38,100	46,038		4,87	29	NTN
4T-67390	133,350		46,038				2,20	29	NTN
4T-67390/67322	133,350	196,850	46,038	38,100	46,038		4,63	29	NTN
4T-67390/67322D+A	133,350	196,850	101,600				9,91	30	NTN
4T-67391	133,350		46,038				3,13	29	NTN
4T-67391/67322	133,350	196,850	46,038	38,100	46,038		4,59	29	NTN
4T-67391/67322D+A	133,350	196,850	101,600				9,37	30	NTN
4T-677	85,725		41,275				2,93	29	NTN

Reference						Kg	 Brands	
	d	D	B	C	T			
4T-67720		247,650		38,100		2,50	29	NTN
4T-67720D		247,650		84,138		5,00	29	NTN
4T-67780/67720D+A	165,100	247,650	103,880			17,06	30	NTN
4T-67786	174,625		47,625			4,49	29	NTN
4T-67786/67720	174,625	247,650	47,625	38,100	47,625	7,00	29	NTN
4T-67787	174,625		47,625			4,54	29	NTN
4T-67787/67720	174,625	247,650	47,625	38,100	47,625	7,00	29	NTN
4T-67787/67720DC+A	174,625	247,650	103,188			15,10	30	NTN
4T-67790	177,800		47,625			4,21	29	NTN
4T-67790/67720	177,800	247,650	47,625	38,100	47,625	6,57	29	NTN
4T-67790/67720CD+A	177,800	247,650	103,188			14,30	30	NTN
4T-67790D		214,000		90,488		8,41	29	NTN
E-67791D/67720/67721D	177,800	247,650	192,088			29,40	32	NTN
67791D/67720/67721D (CRO-3664)	177,800	247,650	192,088			29,40	32	NTN
T-67885D/67820/67820D	190,500	266,700	187,325			33,60	32	NTN
T-E-67885D/67820/67820D	190,500	266,700	187,325			33,60	32	NTN
4T-67920		282,575		36,512		2,81	29	NTN
4T-67983	203,200		46,038			3,50	29	NTN
67983/67920	203,200	282,575	46,038			8,55	29	NTN
T-67983/67920	203,200	282,575	46,038	36,512	46,038	7,76	29	NTN
T-67983/67920D+A	203,200	282,575	101,600			17,10	30	NTN
4T-67985/67920	206,375	282,575	46,038	36,512	46,038	10,37	29	NTN
T-67985/67920	206,375	282,575	46,038	36,512	46,038	8,40	29	NTN
4T-67985/67920D+A	206,375	282,575	101,600			16,50	30	NTN
T-67985/67920D+A	206,375	282,575	101,600			16,50	30	NTN
T-67986D/67920/67920D	206,375	282,575	190,500			35,40	32	NTN
T-67989/67920	209,550	282,575	46,038	36,512	46,038	7,23	29	NTN
T-67989/67920D+A	209,550	282,575	101,600			16,00	30	NTN
680235/680270	596,900	685,800	31,750			15,80	29	NTN
CRD-6804	340,000	470,000	110,000			57,80	31	NTN
CRI-6808	340,000	460,000	160,000			70,00	30	NTN
4T-681	92,075		41,275			2,62	29	NTN
4T-681/672	92,075	168,275	41,275	30,162	41,275	3,87	29	NTN
4T-L68110		59,131		11,938		0,06	29	NTN
4T-L68111		59,974		11,938		0,06	29	NTN
4T-JL68111Z		60,000		11,938		0,06	29	NTN
CRI-6812	340,000	500,000	249,000			154,00	30	NTN
4T-JL68145	34,988		18,460			0,12	29	NTN
4T-JL68145/JL68111Z	35,000	60,000	18,460	11,938	18,410	0,18	29	NTN
4T-L68149	34,988		16,764			0,11	29	NTN
4T-L68149/L68110	34,988	59,131	16,764	11,938	16,764	0,17	29	NTN
4T-L68149/L68111	34,988	59,974	16,764	11,938	16,764	0,18	29	NTN
CR-6816	340,000	440,000	40,000	29,000	40,000	14,60	29	NTN
CR1-6817	340,000	500,000	249,220			168,00	30	NTN
4T-681A	92,075		41,275			2,62	29	NTN
4T-681A/672	92,075	168,275	41,275	30,162	41,275	3,87	29	NTN
4T-683	95,250		41,275			1,40	29	NTN
4T-683/672	95,250	168,275	41,275	30,162	41,275	3,70	29	NTN
4T-68450	114,300		31,750			1,88	29	NTN
4T-68462	117,475		31,750			1,72	29	NTN
4T-68462/68712	117,475	180,975	31,750	25,400	34,925	2,76	29	NTN
4T-685	98,425		41,275			2,80	29	NTN





Reference	d		D		B	C	T	Kg	Brands
	d	D	B	C	T				
4T-685/672	98,425	168,275	41,275	30,162	41,275	3,56	29	NTN	
4T-687	101,600		41,275			2,70	29	NTN	
4T-687/672	101,600	168,275	41,275	30,162	41,275	3,40	29	NTN	
4T-687/672D+A	101,600	168,275	41,275	69,850	92,075	7,29	29	NTN	
4T-68712		180,975		25,400		1,88	29	NTN	
LL687949/LL687910	977,900	1 130,300	63,500	47,625	66,675	103,00	29	NTN	
LL687949/LL687910D+A	977,900	1 130,300	139,700			196,00	30	NTN	
688TD/672+A	95,250	168,275	95,250			8,06	31	NTN	
CR-6902DF	342,900	508,000	469,900			167,00	30	NTN	
CR-6903	342,900	508,000	82,550	55,562	82,550	49,70	29	NTN	
E-CRD-6908	345,000	550,000	270,000			218,00	31	NTN	
NA691/672D	101,600	168,275	92,075			7,29	30	NTN	
CRO-6910 (CRO-6944)	343,052	457,098	254,000			105,00	32	NTN	
CRO-6920LL	343,052	457,098	254,000			107,00	32	NTN	
CRO-6930LL	343,052	457,098	254,000			105,00	32	NTN	
4T-JL69310		63,000		13,500		0,07	29	NTN	
4T-JL69345/JL69310	38,000	63,000	17,000	13,500	19,000	0,21	29	NTN	
4T-JL69349	38,000		17,000			0,13	29	NTN	
4T-JL69349/JL69310	38,000	63,000	17,000	13,500	17,000	0,20	29	NTN	
CRO-6936LL	343,052	457,098	299,000			130,00	32	NTN	
EE700090D/700167/700168D	228,600	425,450	349,250			232,00	32	NTN	
E-EE700090D/700167/700168D	228,600	425,450	349,250			232,00	32	NTN	
E-EE700090D/700167+A	228,600	425,450	177,800			115,00	31	NTN	
CRD-7004	350,000	618,000	200,000			252,00	31	NTN	
CRD-7011	350,000	590,000	192,000			218,00	31	NTN	
CRD-7015	350,000	480,000	110,000			58,70	31	NTN	
CRD-7017	350,000	590,000	192,000			209,00	31	NTN	
E-CRD-7018LL	350,000	480,000	420,000			207,50	31	NTN	
4T-JLM704610		84,000		17,500		0,16	29	NTN	
4T-JLM704649	50,000		22,000			0,30	29	NTN	
4T-JLM704649/JLM704610	50,000	84,000	22,000	17,500	22,000	0,46	29	NTN	
CRO-7105	355,000	490,000	316,000			170,00	32	NTN	
E-CRO-7105	355,000	490,000	316,000			170,00	32	NTN	
4T-JLM710910		105,000		18,500		0,23	29	NTN	
4T-JLM710949	65,000		23,000			0,50	29	NTN	
4T-JLM710949/JLM710910	65,000	105,000	23,000	18,500	24,000	0,74	29	NTN	
4T-JLM710949C	65,000		23,000			0,50	29	NTN	
4T-JLM710949C/JLM710910	65,000	105,000	23,000	18,500	24,000	0,74	29	NTN	
CRO-7109LL	355,000	490,000	316,000			159,00	32	NTN	
4T-L713010		101,600		15,083		0,18	29	NTN	
4T-L713049	69,850		19,050			0,33	29	NTN	
4T-L713049/L713010	69,850	101,600	19,050	15,083	19,050	0,51	29	NTN	
4T-JLM714110		115,000		19,000		0,27	29	NTN	
4T-JLM714149	75,000		25,000			0,60	29	NTN	
4T-JLM714149/JLM714110	75,000	115,000	25,000	19,000	25,000	0,88	29	NTN	
4T-JM714210		120,000		25,000		0,42	29	NTN	
4T-JM714249	75,000		29,500			0,84	29	NTN	
4T-JM714249/JM714210	75,000	120,000	29,500	25,000	31,000	1,28	29	NTN	
4T-71437/71751D+A	111,125	190,500	106,362			11,70	30	NTN	
4T-71450	114,300		49,212			3,39	29	NTN	
4T-71450/71750	114,300	190,500	49,212	34,925	49,212	5,17	29	NTN	
4T-NA71450/71751D	114,300	190,500	106,362			11,10	30	NTN	

Reference						Kg	?	Brands
	d	D	B	C	T			
4T-71453/71750	115,087	190,500	49,212	34,925	47,625	5,11	29	NTN
4T-71453/71751D+A	115,087	190,500	106,362			11,10	30	NTN
4T-71453/71751DC+A	115,087	190,500	106,362			11,10	30	NTN
4T-H715311		136,525		36,512		0,94	29	NTN
4T-H715334	61,912		46,038			2,49	29	NTN
4T-H715334/H715311	61,912	136,525	46,038	36,512	46,038	3,47	29	NTN
4T-H715341A	66,675		46,038			2,32	29	NTN
4T-H715341A/H715311	66,675	136,525	46,038	36,512	46,038	3,26	29	NTN
4T-H715343	68,262		46,038			2,28	29	NTN
4T-H715343/H715311	68,262	136,525	46,038	36,512	46,038	3,24	29	NTN
4T-H715345	71,438		46,038			2,14	29	NTN
4T-H715345/H715311	71,438	136,525	46,038	36,512	46,038	3,11	29	NTN
4T-H715347/H715311	70,000	136,525	46,038	36,512	46,038	2,82	29	NTN
4T-H715348	77,788		46,038			1,86	29	NTN
4T-H715348/H715311	77,788	136,525	46,038	36,512	46,038	2,84	29	NTN
4T-JM716610		130,000		24,000		0,45	29	NTN
4T-JM716648	85,000		29,000			0,89	29	NTN
4T-JM716648/JM716610	85,000	130,000	29,000	24,000	30,000	1,35	29	NTN
4T-JM716649	85,000		29,000			0,92	29	NTN
4T-JM716649/JM716610	85,000	130,000	29,000	24,000	30,000	1,37	29	NTN
4T-71750		190,500		34,925		1,78	29	NTN
4T-JM718110		145,000		27,000		0,65	29	NTN
4T-JM718149	90,000		34,000			1,46	29	NTN
4T-JM718149/JM718110	90,000	145,000	34,000	27,000	35,000	2,11	29	NTN
4T-JM719113		150,000		27,000		0,77	29	NTN
4T-JM719149	95,000		34,000			1,41	29	NTN
4T-JM719149/JM719113	95,000	150,000	34,000	27,000	35,000	2,17	29	NTN
CRD-7201	360,000	540,000	200,000			161,00	31	NTN
4T-JHM720210		160,000		32,000		0,97	29	NTN
4T-JM720210		155,000		28,000		0,77	29	NTN
4T-JHM720249	100,000		40,000			2,07	29	NTN
4T-JM720249	100,000		35,000			1,63	29	NTN
4T-JHM720249/JHM720210	100,000	160,000	40,000	32,000	41,000	3,04	29	NTN
4T-JM720249/JM720210	100,000	155,000	35,000	28,000	36,000	2,40	29	NTN
CRD-7207	360,000	680,000	320,000			570,00	31	NTN
CRO-7210	360,000	600,000	540,000			520,00	32	NTN
E-CRO-7210	360,000	600,000	540,000			520,00	32	NTN
CRO-7211	360,000	540,000	340,000			270,00	32	NTN
CRO-7217	360,000	520,000	410,000			297,00	32	NTN
4T-72188C	47,625		32,791			1,36	29	NTN
4T-72188C/72487	47,625	123,825	32,791	25,400	36,512	2,14	29	NTN
CRO-7220	360,000	520,000	370,000			260,00	32	NTN
4T-72200C	50,800		32,791			1,30	29	NTN
4T-72200C/72487	50,800	123,825	32,791	25,400	36,512	2,08	29	NTN
EE722110/722185	279,400	469,900	93,662	69,850	95,250	65,30	29	NTN
EE722110/722186D+A	279,400	469,900	200,025			125,00	30	NTN
EE722111D/722185/722186D	279,400	469,900	346,075			258,00	32	NTN
E-EE722111D/722185/722186D	279,400	469,900	346,075			258,00	32	NTN
EE722115/722185	292,100	469,900	93,662	69,850	95,250	62,00	29	NTN
EE722115/722186D+A	292,100	469,900	200,025			118,00	30	NTN
4T-72212C	53,975		32,791			1,24	29	NTN
4T-72212C/72487	53,975	123,825	32,791	25,400	36,512	2,00	29	NTN





Reference	D		B	C	T	Kg	?	Brands
	d	D	B	C	T			
4T-72218C	55,562		32,791			1,20	29	NTN
4T-72218C/72487	55,562	123,825	32,791	25,400	36,512	1,99	29	NTN
4T-72225C	57,150		32,791			1,16	29	NTN
4T-72225C/72487	57,150	123,825	32,791	25,400	36,512	1,96	29	NTN
CR-7222DB	360,000	480,000	480,000			211,00	30	NTN
CR0-7226LL	360,000	480,000	375,000			180,00	32	NTN
EE724120/724195	304,800	495,300	92,075	69,850	95,250	69,70	29	NTN
E-EE724120/724195	304,800	495,300	92,075	69,850	95,250	69,80	29	NTN
EE724120/724196D+A	304,800	495,300	196,850			131,00	30	NTN
EE724121D/724195/724196D	304,800	495,300	342,900			273,00	32	NTN
E-EE724121D/724195/724196D	304,800	495,300	342,900			273,00	32	NTN
4T-72487		123,825		25,400		0,78	29	NTN
4T-LM72810		47,000		12,000		0,05	29	NTN
4T-LM72849/LM72810	22,606	47,000	15,500	12,000	15,500	0,13	29	NTN
4T-JM734410		240,000		37,000		2,00	29	NTN
4T-JM734449	170,000		44,501			4,24	29	NTN
4T-JM734449/JM734410	170,000	240,000	44,501	37,000	46,000	6,23	29	NTN
LL735449/LL735410	177,800	215,900	20,638	15,083	20,638	1,40	29	NTN
4T-LL735449/LL735410	177,800	215,900	20,638	15,083	20,638	1,40	29	NTN
4T-JM736149/JM736110	180,000	250,000	45,000	37,000	47,000	6,72	29	NTN
EE736173D/736238/736239D	432,003	609,524	317,500			297,00	32	NTN
E-EE736173D/736238/736239D	432,003	609,524	317,500			297,00	32	NTN
EE737179D/737260/737260D	457,200	660,400	323,850			379,00	32	NTN
E-EE737179D/737260/737260D	457,200	660,400	323,850			379,00	32	NTN
4T-JM738210		260,000		36,500		2,20	29	NTN
4T-JM738249	190,000		44,000			4,61	29	NTN
4T-JM738249/JM738210	190,000	260,000	44,000	36,500	46,000	6,78	29	NTN
4T-LM739710		257,175		30,162		1,74	29	NTN
4T-LM739749	196,850		39,688			3,59	29	NTN
LM739749/LM739710	196,850	257,175	39,688	30,162	39,688	5,33	29	NTN
4T-LM739749/LM739710	196,850	257,175	39,688	30,162	39,688	5,33	29	NTN
4T-740	80,962		46,672			2,50	29	NTN
4T-740/742	80,962	150,089	46,672	36,512	46,672	3,50	29	NTN
CRD-7401	370,000	630,000	240,000			316,00	31	NTN
CRI-7402	370,000	680,000	280,000			420,00	30	NTN
4T-742		150,089		36,512		1,10	29	NTN
4T-LM742710		285,750		34,925		2,40	29	NTN
T-LM742745/LM742710	212,725	285,750	46,038	34,925	46,038	7,33	29	NTN
T-LM742745/LM742710D+A	212,725	285,750	98,425			15,70	30	NTN
T-LM742747/LM742710	216,408	285,750	49,212	34,925	46,038	7,40	29	NTN
LM742749/LM742710A	215,900	285,750	46,038	34,925	46,038	7,45	29	NTN
T-LM742749/LM742710	215,900	285,750	46,038	34,925	46,038	7,05	29	NTN
T-LM742749/LM742710D+A	215,900	285,750	98,425			15,10	30	NTN
E-LM742749D/LM742714/LM742714D	215,900	288,925	177,800			34,30	32	NTN
T-LM742749D/LM742710+A	215,900	285,750	85,725			14,80	31	NTN
T-LM742749D/LM742714/LM742714D	215,900	288,925	177,800			34,30	32	NTN
4T-LM742749E1	215,900		46,038			5,23	29	NTN
4T-743		150,000		35,000		1,03	29	NTN
EE743240/743320	609,600	812,800	82,550	60,325	82,550	104,00	29	NTN
EE743240/743321D+A	609,600	812,800	190,500			241,00	30	NTN
4T-744	73,025		46,672			2,73	29	NTN
4T-744/742	73,025	150,089	46,672	36,512	44,450	3,79	29	NTN

Reference						Kg	?	Brands
	d	D	B	C	T			
4T-74500/74850	127,000	215,900	47,625	34,925	47,625	7,05	29	NTN
4T-74500/74851D+A	127,000	215,900	106,362			15,50	30	NTN
4T-74525	133,350		47,625			4,60	29	NTN
4T-74525/74850	133,350	215,900	47,625	34,925	47,625	6,56	29	NTN
NA74525/74851D	133,350	215,900	106,362			13,50	30	NTN
4T-74525/74851D+A	133,350	215,900	106,362			13,90	30	NTN
4T-74550	139,700		47,625			4,10	29	NTN
4T-74550/74845	139,700	214,975	47,625	34,925	47,625	5,97	29	NTN
4T-74550/74850	139,700	215,900	47,625	34,925	47,625	6,05	29	NTN
4T-74550A	139,700		47,625			4,08	29	NTN
4T-74550A/74850	139,700	215,900	47,625	34,925	47,625	6,03	29	NTN
4T-745A	69,850		46,672			2,86	29	NTN
4T-745A/742	69,850	150,089	46,672	36,512	46,672	3,92	29	NTN
HM746646/HM746610	228,600	355,600	69,850	50,800	69,850	22,70	29	NTN
HM746646/HM746610D+A	228,600	355,600	152,400			49,40	30	NTN
4T-748	80,000		46,672			2,42	29	NTN
4T-74850		215,900		34,925		1,95	29	NTN
4T-748S	76,200		46,672			2,58	29	NTN
4T-748S/742	76,200	150,089	46,672	36,512	46,672	3,64	29	NTN
4T-749	85,026		46,672			2,16	29	NTN
4T-749/742	85,026	150,089	46,672	36,512	46,672	3,23	29	NTN
4T-749A	82,550		46,672			2,30	29	NTN
4T-749A/742	82,550	150,089	46,672	36,512	46,672	3,37	29	NTN
4T-749A/742D	82,550	155,575	101,600			7,30	30	NTN
4T-749A/742D+A	82,550	155,575	101,600			7,50	30	NTN
4T-752		161,925		38,100		1,70	29	NTN
EE752295/752380DB	749,300	965,200	362,320			660,00	30	NTN
EE752305/752380	774,700	965,200	80,962	66,675	93,662	126,00	29	NTN
4T-753		168,275		38,100		2,10	29	NTN
4T-755	76,200		48,260			3,11	29	NTN
4T-755/752	76,200	161,925	48,260	38,100	48,260	4,72	29	NTN
EE755280/755360G2	711,200	914,400	82,550	60,325	85,725	136,00	29	NTN
EE755280/755361DG2+A	711,200	914,400	190,500			275,00	30	NTN
EE755280D/755360/755361DG2	711,200	914,400	317,500			527,00	32	NTN
EE755281D/755360/755361DG2	711,200	914,400	317,500			527,00	32	NTN
E-EE755281D/755360/755361DG2	711,200	914,400	317,500			527,00	32	NTN
EE755281D/755360G2+A	711,200	914,400	149,225			243,00	31	NTN
EE755285/755360G2	723,900	914,400	80,962	60,325	84,138	126,00	29	NTN
EE755285/755361DG2+A	723,900	914,400	187,325			256,00	30	NTN
4T-756A	79,375		48,260			2,94	29	NTN
4T-756A/752	79,375	161,925	48,260	38,100	47,625	4,55	29	NTN
4T-757	82,550		48,260			2,81	29	NTN
4T-757/752	82,550	161,925	48,260	38,100	47,625	4,42	29	NTN
4T-757/753	82,550	168,275	48,260	38,100	48,260	4,91	29	NTN
T-LM757049/LM757010	304,800	406,400	63,500	47,625	63,500	20,10	29	NTN
E-M757448D/M757410/M757410D	304,648	438,048	280,990			140,00	32	NTN
M757448D/M757410/M757410D	304,648	438,048	280,990			140,00	32	NTN
E-M757449D/M757410/M757410D	305,003	438,048	280,990			139,00	32	NTN
M757449D/M757410/M757410D	305,003	438,048	280,990			139,00	32	NTN
M757449D/M757410+A	305,000	438,048	134,145			65,30	31	NTN
4T-758	85,725		48,260			2,65	29	NTN
4T-758/752	85,725	161,925	48,260	38,100	48,260	4,26	29	NTN





Reference	d		D		B	C	T	Kg	Brands
	d	D	B	C	T				
4T-759	88,900		48,260				2,48	29	NTN
4T-759/752	88,900	161,925	48,260	38,100	48,260		4,09	29	NTN
4T-NA759/752D	88,900	161,925	104,775				7,48	30	NTN
4T-NA759SW/752D	88,900	161,925	104,775				7,48	30	NTN
4T-NA759SW/K312486	88,900	206,375	104,775				12,14	30	NTN
4T-760	90,488		48,260				2,40	29	NTN
4T-760/752	90,488	161,925	48,260	38,100	47,625		4,01	29	NTN
CRD-7612	380,000	650,000	240,000				338,20	31	NTN
CRO-7612	380,000	560,000	285,000				208,00	32	NTN
E-CRO-7612	380,000	560,000	285,000				208,00	32	NTN
CRD-7614	380,000	559,500	160,000				133,00	31	NTN
CRI-7614	380,000	620,000	241,000				252,00	30	NTN
CRD-7615	379,000	681,500	307,000				525,00	31	NTN
E-LM761648D/LM761610/LM761610D	341,312	457,098	254,000				125,00	32	NTN
LM761648D/LM761610/LM761610D	341,312	457,098	254,000				125,00	32	NTN
E-LM761649D/LM761610/LM761610D	343,052	457,098	254,000				111,86	32	NTN
LM761649D/LM761610/LM761610D (CRO-6945)	343,052	457,098	254,000				117,00	32	NTN
LM761649D/LM761610+A	343,052	457,098	122,238				55,00	31	NTN
CRI-7619	380,000	508,000	139,700				69,50	30	NTN
CRD-7621	379,000	681,500	307,000				525,00	31	NTN
CRO-7621	380,000	560,000	360,000				312,00	32	NTN
CRO-7622	380,000	560,000	360,000				302,22	32	NTN
CRD-7623	380,000	650,000	240,000				329,00	31	NTN
E-CRD-7631	380,000	550,000	255,000				185,00	31	NTN
EE763330/763410G2	838,200	1 041,400	88,900	66,675	93,662		172,00	29	NTN
E-LM763449D/LM763410/LM763410D	355,600	482,600	265,112				145,00	32	NTN
LM763449D/LM763410/LM763410D (CRO-7123)	355,600	482,600	265,112				145,00	32	NTN
LM763449D/LM763410+A	355,600	482,600	128,588				67,40	31	NTN
E-LM765149D/LM765110/LM765110D	374,650	501,650	250,825				145,00	32	NTN
LM765149D/LM765110/LM765110D	368,300	501,650	250,825				145,00	32	NTN
E-LM767745D/LM767710/LM767710D	393,700	546,100	288,925				219,00	32	NTN
LM767745D/LM767710/LM767710D	393,700	546,100	288,925				219,00	32	NTN
LM767745D/LM767710+A	393,700	546,100	138,112				97,40	31	NTN
E-LM767749D/LM767710/LM767710D	406,400	546,100	288,925				190,00	32	NTN
LM767749D/LM767710/LM767710D	406,400	546,100	288,925				201,00	32	NTN
LM767749D/LM767710+A	406,400	546,100	138,112				90,50	31	NTN
E-LM769349D/LM769310/LM769310D	431,800	571,500	336,550				232,00	32	NTN
LM769349D/LM769310/LM769310D	431,800	571,500	336,550				232,00	32	NTN
LM769349D/LM769310+A	431,800	571,500	161,925				112,00	31	NTN
CRD-7701	385,000	530,000	180,000				116,00	31	NTN
E-L770847D/L770810/L770810D	457,200	596,900	279,400				200,90	32	NTN
L770847D/L770810AG2+A	457,200	596,900	133,350				96,70	31	NTN
L770849D/L770810/L770810D	457,200	596,900	276,225				201,00	32	NTN
E-L770849D/L770810/L770810DG2	457,200	596,900	276,225				209,00	32	NTN
L770849D/L770810+A	457,200	596,900	133,350	52,388	133,350		96,70	31	NTN
LM770949/LM770910	457,200	603,250	84,138	60,325	85,725		63,80	29	NTN
LL771948/LL771911	476,250	565,150	41,275	31,750	41,275		16,70	29	NTN
4T-772		180,975		38,100			2,00	29	NTN
LM772748/LM772710A	488,950	634,873	84,138	61,912	84,138		60,30	29	NTN
LM772748/LM772710DA+A	488,950	634,873	180,975				130,00	30	NTN
E-LM772749D/LM772710/LM772710DA	489,026	634,873	320,675				268,00	32	NTN
LM772749D/LM772710/LM772710DA	489,026	634,873	320,675				268,00	32	NTN

Reference						Kg		Brands
	d	D	B	C	T			
LM772749D/LM772710A+A	489,026	634,873	153,988			124,00	31	NTN
4T-77375/77675	95,250	171,450	48,260	38,100	47,625	4,58	29	NTN
EE776420/776520	1 066,800	1 320,800	88,900	69,850	95,250	796,00	29	NTN
EE776430/776520	1 092,200	1 320,800	88,900	69,850	95,250	794,00	29	NTN
4T-778	92,075		48,006			3,72	29	NTN
T-LL778149/LL778110	584,200	685,800	49,212	34,925	49,212	27,80	29	NTN
E-LM778549D/LM778510/LM778510DG2	584,200	762,000	396,875			511,00	32	NTN
LM778549D/LM778510/LM778510DG2	584,200	762,000	188,912	169,862	396,875	511,00	32	NTN
LM778549D/LM778510G2+A	584,200	762,000	188,912			223,00	31	NTN
4T-779	98,425		48,006			3,66	29	NTN
4T-780	101,600		48,006			3,17	29	NTN
4T-780/772	101,600	180,975	48,006	38,100	48,006	5,11	29	NTN
CRO-7801	390,000	510,000	350,000			186,00	32	NTN
CRI-7803	390,000	600,000	185,000			175,00	30	NTN
CR1-7808	390,000	600,000	185,000			165,00	30	NTN
4T-782	104,775		48,006			2,98	29	NTN
4T-782/772	104,775	180,975	48,006	38,100	48,006	4,92	29	NTN
4T-78214	53,975		33,236			1,83	29	NTN
4T-78214/78551	53,975	140,030	33,236	23,520	36,512	2,74	29	NTN
4T-78214C/78551	53,975	140,030	33,236	23,520	36,512	2,77	29	NTN
4T-78215C	53,975		33,236			1,84	29	NTN
4T-78215C/78551	53,975	140,030	33,236	23,520	36,512	2,74	29	NTN
4T-78225	57,150		33,236			1,75	29	NTN
4T-78225/78551	57,150	140,030	33,236	23,520	36,512	2,69	29	NTN
4T-78238	60,337		33,236			1,67	29	NTN
4T-78238/78537	60,325	136,525	33,236	23,520	36,512	2,44	29	NTN
4T-78250	63,500		33,236			1,60	29	NTN
4T-78250/78551	63,500	140,030	33,236	23,520	36,512	2,54	29	NTN
4T-LM78310A		61,973		13,600		0,07	29	NTN
4T-LM78349	34,988		17,000			0,13	29	NTN
4T-LM78349/LM78310A	34,988	61,973	17,000	13,600	17,000	0,20	29	NTN
4T-78537		136,525		23,520		0,77	29	NTN
4T-78551		140,030		23,520		0,92	29	NTN
4T-786	104,775		48,006			2,96	29	NTN
4T-786/772	104,775	180,975	48,006	38,100	48,006	4,90	29	NTN
LL788345/LL788310	1 063,625	1 219,200	65,088	42,862	65,088	422,00	29	NTN
LL788349/LL788310	1 066,800	1 219,200	65,088	42,862	65,088	422,00	29	NTN
CRO-7901	395,000	545,000	268,700			200,00	32	NTN
E-CRO-7901	395,000	545,000	268,700			200,00	32	NTN
EE790114/790221	292,100	558,800	136,525	98,425	136,525	135,00	29	NTN
EE790120/790221	304,800	558,800	136,525	98,425	136,525	131,00	29	NTN
CR-7901DF	393,700	546,100	469,900			153,00	30	NTN
4T-792		206,375		34,925		2,00	29	NTN
4T-795	120,650		47,625			4,45	29	NTN
4T-795/792D	120,650	206,375	107,950			13,30	30	NTN
4T-795/792D+A	120,650	206,375	107,950			13,30	30	NTN
NA798/792D	127,000	206,375	107,950			12,58	30	NTN
4T-799	128,588		47,625			3,87	29	NTN
4T-799/792	128,588	206,375	47,625	34,925	47,625	5,77	29	NTN
4T-799A/792	130,175	206,375	47,625	34,925	47,625	5,65	29	NTN
CRI-8005	400,000	540,000	140,000			80,60	30	NTN
CRO-8005	400,000	560,000	380,000			300,00	32	NTN





Reference	d		D		B	C	T	Kg	Brands
	d	D	B	C	T				
E-CRD-8005	400,000	560,000	380,000				300,00	32	NTN
CRD-8008	400,000	590,000	142,000				134,00	31	NTN
CRD-8010	400,000	650,000	200,000				260,00	31	NTN
CRD-8010	400,000	635,000	470,000				564,00	32	NTN
CRD-8012	400,000	590,000	142,000				134,00	31	NTN
CRD-8013	400,000	650,000	240,000				303,00	31	NTN
4T-HM801310		82,550		23,020			0,28	29	NTN
4T-HM801346	38,100		28,575				0,48	29	NTN
4T-HM801346/HM801310	38,100	82,550	28,575	23,020	29,370		0,77	29	NTN
4T-HM801346X	38,100		28,575				0,48	29	NTN
4T-HM801346X/HM801310	38,100	82,550	28,575	23,020	29,370		0,76	29	NTN
4T-HM801349	40,483		28,575				0,44	29	NTN
4T-HM801349/HM801310	40,483	82,550	28,575	23,020	29,370		0,73	29	NTN
CRD-8014	400,000	650,000	240,000				303,00	31	NTN
CRD-8017	400,000	650,000	250,000				325,00	31	NTN
80170/80217	431,800	552,450	44,450	31,750	44,450		23,10	29	NTN
80176/80217	447,675	552,450	44,450	31,750	44,450		20,40	29	NTN
80180/80217	457,200	552,450	44,450	31,750	44,450		18,70	29	NTN
80180/80217A	457,200	552,450	44,450	31,750	44,450		19,30	29	NTN
4T-M802011		82,550		20,193			0,23	29	NTN
4T-M802048	41,275		25,654				0,41	29	NTN
4T-M802048/M802011	41,275	82,550	25,654	20,193	26,543		0,64	29	NTN
CRD-8023	400,000	650,000	240,000				303,00	31	NTN
CRD-8026	400,000	650,000	240,000				303,00	31	NTN
E-CRD-8026	400,000	650,000	240,000				292,00	31	NTN
CRD-8027	400,000	650,000	240,000				303,00	31	NTN
CRD-8029	400,000	730,000	340,000				672,00	31	NTN
4T-HM803110		88,925		23,020			0,32	29	NTN
4T-HM803112		92,075		23,020			0,39	29	NTN
4T-HM803145/HM803110	41,275	88,900	29,370	23,020	30,162		0,90	29	NTN
4T-HM803146	41,275		29,370				0,57	29	NTN
4T-HM803146/HM803110	41,275	88,900	29,370	23,020	30,162		0,89	29	NTN
4T-HM803149	44,450		29,370				0,53	29	NTN
4T-HM803149/HM803110	44,450	88,900	29,370	23,020	30,162		0,85	29	NTN
4T-HM803149/HM803111	44,450	88,900	29,370	23,020	30,162		0,85	29	NTN
4T-HM803149/HM803112	44,450	92,075	29,370	23,020	30,162		0,92	29	NTN
CRD-8032	400,000	650,000	240,000				303,00	31	NTN
CRD-8034	400,000	650,000	240,000				303,00	31	NTN
CRD-8035	400,000	650,000	240,000				303,00	31	NTN
CRD-8038	400,000	650,000	240,000				302,00	31	NTN
80385/80325	431,800	533,400	46,038	34,925	46,038		19,80	29	NTN
T-80385/80325	431,800	533,400	46,038	34,925	46,038		19,70	29	NTN
CRD-8039	400,000	650,000	240,000				303,00	31	NTN
CRD-8040	400,000	780,000	380,000				895,00	31	NTN
4T-M804010		88,900		19,050			0,21	29	NTN
4T-M804048	47,625		25,400				0,44	29	NTN
4T-M804048/M804010	47,625	88,900	25,400	19,050	25,400		0,66	29	NTN
4T-M804049	47,625		25,400				0,44	29	NTN
4T-M804049/M804010	47,625	88,900	25,400	19,050	25,400		0,65	29	NTN
CRD-8042	400,000	650,000	240,000				303,00	31	NTN
CRD-8044	400,000	650,000	240,000				292,00	31	NTN
E-CRD-8044	400,000	650,000	240,000				292,00	31	NTN

Reference						Kg	?	Brands
	d	D	B	C	T			
CRD-8046	400,000	650,000	240,000			303,00	31	NTN
CRD-8047	400,000	650,000	240,000			303,00	31	NTN
CRD-8048	400,000	650,000	240,000			303,00	31	NTN
4T-HM804810		95,250		23,020		0,35	29	NTN
4T-HM804840	41,275		29,370			0,72	29	NTN
4T-HM804840/HM804810	41,275	95,250	29,370	23,020	30,162	1,08	29	NTN
4T-HM804842	44,450		29,370			0,68	29	NTN
4T-HM804842/HM804810	44,450	95,250	29,370	23,020	30,162	1,04	29	NTN
4T-HM804843	44,450		29,370			0,67	29	NTN
4T-HM804843/HM804810	44,450	95,250	29,370	23,020	30,162	1,02	29	NTN
4T-HM804846	47,625		29,370			0,62	29	NTN
4T-HM804846/HM804810	47,625	95,250	29,370	23,020	30,162	0,98	29	NTN
4T-HM804848	48,412		29,370			0,61	29	NTN
4T-HM804848/HM804810	48,412	95,250	29,370	23,020	30,162	0,97	29	NTN
4T-HM804849	48,412		29,370			0,61	29	NTN
4T-HM804849/HM804810	48,412	95,250	29,370	23,020	30,162	0,96	29	NTN
CRD-8049	400,000	650,000	240,000			303,00	31	NTN
4T-LM806610		88,900		13,492		0,13	29	NTN
4T-LM806649	53,975		19,050			0,30	29	NTN
4T-LM806649/LM806610	53,975	88,900	19,050	13,492	19,050	0,44	29	NTN
4T-HM807010		104,775		28,575		0,49	29	NTN
4T-HM807011		104,775		28,575		0,50	29	NTN
4T-JHM807012		105,000		29,000		0,52	29	NTN
4T-HM807040	44,450		36,512			1,12	29	NTN
4T-HM807040/HM807010	44,450	104,775	36,512	28,575	36,512	1,62	29	NTN
4T-HM807044	49,212		36,512			1,01	29	NTN
4T-HM807044/HM807010	49,212	104,775	36,512	28,575	36,512	1,52	29	NTN
4T-JHM807045	50,000		36,000			1,00	29	NTN
4T-JHM807045/JHM807012	50,000	105,000	36,000	29,000	37,000	1,52	29	NTN
4T-HM807046	50,800		36,512			0,98	29	NTN
4T-HM807046/HM807010	50,800	104,775	36,512	28,575	36,512	1,49	29	NTN
4T-HM807048	54,488		36,512			0,89	29	NTN
4T-HM807048/HM807010	54,500	104,775	36,512	28,575	36,512	1,38	29	NTN
4T-HM807049	53,975		36,512			0,90	29	NTN
4T-HM807049/HM807010	53,975	104,775	36,512	28,575	36,512	1,41	29	NTN
80780/80720	635,000	736,600	53,975	41,275	57,150	38,30	29	NTN
CRO-8103	406,400	565,150	381,000			310,00	32	NTN
4T-L812111		103,213		11,989		0,12	29	NTN
4T-L812148	66,675		17,602			0,34	29	NTN
4T-L812148/L812111	66,675	103,213	17,602	11,989	17,602	0,48	29	NTN
4T-JLM813010		110,000		20,500		0,30	29	NTN
4T-JLM813049	70,000		25,000			0,58	29	NTN
4T-JLM813049/JLM813010	70,000	110,000	25,000	20,500	26,000	0,88	29	NTN
4T-HM813810		127,000		26,988		0,60	29	NTN
4T-HM813840	55,562		36,512			1,70	29	NTN
4T-HM813840/HM813810	55,562	127,000	36,512	26,988	36,512	2,34	29	NTN
4T-HM813841	60,325		36,512			1,57	29	NTN
4T-HM813841/HM813810	60,325	127,000	36,512	26,988	36,512	2,21	29	NTN
4T-HM813842	63,500		36,512			1,48	29	NTN
4T-HM813842/HM813810	63,500	127,000	36,512	26,988	36,512	2,12	29	NTN
4T-HM813843	61,912		36,512			1,54	29	NTN
4T-HM813844	66,675		36,512			1,39	29	NTN





Reference	d D		B	C	T	Kg	?	Brands
	d	D	B	C	T			
4T-HM813844/HM813810	66,675	127,000	36,512	26,988	36,512	2,03	29	NTN
4T-HM813846/HM813810	69,850	127,000	36,512	26,988	36,512	1,90	29	NTN
4T-HM813849	71,438		36,512			1,24	29	NTN
4T-HM813849/HM813810	71,438	127,000	36,512	26,988	36,512	1,84	29	NTN
4T-L814749/L814710	76,200	109,538	19,050	15,083	19,050	0,58	29	NTN
4T-LM814810		117,475		19,050		0,29	29	NTN
4T-LM814849	77,788		25,400			0,63	29	NTN
4T-LM814849/LM814810	77,788	117,475	25,400	19,050	25,400	0,93	29	NTN
81576D/81962/81963D	146,050	244,475	192,088			36,80	32	NTN
E-81576D/81962/81963D	150,000	244,475	192,088			36,80	32	NTN
4T-HM81610		47,000		16,000		0,08	29	NTN
4T-HM81649	16,000		21,000			0,11	29	NTN
4T-JL819310		135,000		14,000		0,26	29	NTN
4T-JL819349	95,000		20,000			0,58	29	NTN
4T-JL819349/JL819310	95,000	135,000	20,000	14,000	20,000	0,84	29	NTN
CRD-8201	410,000	580,000	160,000			133,00	31	NTN
CRO-8204LL	410,000	546,000	400,000			253,00	32	NTN
E-CRO-8205	409,575	546,100	334,962			216,00	32	NTN
4T-HM821547/HM821511D+A	99,979	196,850	103,378			12,00	30	NTN
4T-JM822010		165,000		26,500		0,83	29	NTN
4T-JM822049	110,000		35,000			1,68	29	NTN
4T-JM822049/JM822010	110,000	165,000	35,000	26,500	35,000	2,52	29	NTN
EE822101D/822175/822176D	254,000	444,500	279,400			185,00	32	NTN
E-EE822101D/822175/822176D	254,000	444,500	279,400			185,00	32	NTN
NA82576/82932D	146,050	236,538	131,762			20,08	30	NTN
82576/82932D+A	146,050	236,538	131,762			20,10	30	NTN
4T-82587/J82945	149,225	240,000	56,642	44,450	57,150	9,40	29	NTN
82680X/82620D	177,800	279,400	133,353			28,20	30	NTN
82681D/82620/82620D	177,800	279,400	234,950			55,30	32	NTN
E-82681D/82620/82620D	177,800	279,400	234,950			55,30	32	NTN
4T-832		168,275		41,275		1,74	29	NTN
EE833160X/833232	406,400	590,550	107,950	80,962	107,950	86,60	29	NTN
EE833160XD/833232+A	406,400	590,550	193,675			175,00	31	NTN
EE833161D/833232/833233D	406,400	590,550	400,050			395,00	32	NTN
E-EE833161D/833232/833233D	406,400	590,550	400,050			395,00	32	NTN
4T-835	69,850		56,363			4,39	29	NTN
4T-835/832	69,850	168,275	56,363	41,275	53,975	6,13	29	NTN
CRD-8402	420,000	520,000	90,000			40,90	31	NTN
CRO-8402	420,000	650,000	460,000			600,00	32	NTN
E-CRO-8402	420,000	650,000	460,000			600,00	32	NTN
T-HH840249/HH840210	190,500	336,550	95,250	73,025	98,425	36,40	29	NTN
CRI-8403	420,000	700,000	274,000			387,00	30	NTN
4T-JHM840410		300,000		51,000		5,37	29	NTN
4T-JHM840449	200,000		62,000			10,30	29	NTN
4T-JHM840449/JHM840410	200,000	300,000	62,000	51,000	65,000	15,67	29	NTN
CRD-8405	420,000	735,000	406,000			780,00	31	NTN
4T-841	85,725		56,363			3,54	29	NTN
4T-841/832	85,725	168,275	56,363	41,275	53,975	5,28	29	NTN
CR-8410DB	420,000	540,000	500,000			253,00	30	NTN
CR-8411DB	420,000	560,000	520,000			309,00	30	NTN
E-CRO-8412LL	420,000	620,000	395,000			384,00	32	NTN
CRO-8412LL	420,000	620,000	395,000			384,00	32	NTN

Reference						Kg	?	Brands
	d	D	B	C	T			
E-CR0-8414	420,000	592,000	432,000			372,00	32	NTN
4T-842	82,550		56,363			3,72	29	NTN
4T-842/832	82,550	168,275	56,363	41,275	53,975	5,46	29	NTN
4T-842/834D+A	82,550	171,450	125,412			12,50	30	NTN
4T-M84210		59,530		18,288		0,13	29	NTN
4T-M84249	25,400		23,114			0,19	29	NTN
4T-M84249/M84210	25,400	59,530	23,114	18,288	23,368	0,32	29	NTN
4T-843/834D+A	76,200	171,450	125,412			13,60	30	NTN
EE843220/843290	558,800	736,600	88,108	63,500	88,108	92,00	29	NTN
EE843220/843291D+A	558,800	736,600	187,328			189,00	30	NTN
EE843220D/843290+A	558,800	736,600	155,575			177,00	31	NTN
E-EE843221D/843290/843291D	558,800	736,600	322,265			388,00	32	NTN
EE843221D/843290/843291D (CRO-11217)	558,800	736,600	322,265			388,00	32	NTN
4T-M84510		57,150		14,732		0,09	29	NTN
4T-M84548	25,400		19,431			0,15	29	NTN
4T-M84548/M84510	25,400	57,150	19,431	14,732	19,431	0,24	29	NTN
4T-M84549/M84510	27,000	57,150	19,431	14,732	19,431	0,23	29	NTN
4T-850	88,900		56,363			3,34	29	NTN
4T-850/832	88,900	168,275	56,363	41,275	53,975	5,08	29	NTN
4T-850A/834D+A	89,891	171,450	125,412			15,28	30	NTN
H852849/H852810	266,700	444,500	117,475	88,900	120,650	73,30	29	NTN
E-L853049/L853010	276,225	352,425	34,925	23,812	36,512	7,59	29	NTN
L853049/L853010	276,225	352,425	34,925	23,812	36,512	8,40	29	NTN
4T-854		190,500		44,450		2,69	29	NTN
4T-855	88,900		57,531			5,18	29	NTN
4T-855/854	88,900	190,500	57,531	44,450	57,150	7,93	29	NTN
8573/8520	228,600	327,025	52,388	36,512	52,388	9,90	29	NTN
T-8573/8520	228,600	327,025	52,388	36,512	52,388	12,50	29	NTN
T-8573/8520D+A	228,600	327,025	114,300			27,30	30	NTN
8574/8520CD	234,950	327,025	114,300			25,40	30	NTN
8574/8520CD+A	234,950	327,025	114,300			25,40	30	NTN
T-8575/8520	234,950	327,025	52,388	36,512	52,388	11,90	29	NTN
T-8575/8520D+A	234,950	327,025	114,300			25,90	30	NTN
T-8576D/8520/8520D	234,950	327,025	196,850			53,60	32	NTN
T-E-8576D/8520/8520D	234,950	327,025	196,850			53,60	32	NTN
T-8578/8520	241,300	327,025	52,388	36,512	52,388	11,20	29	NTN
T-8578/8520D+A	241,300	327,025	114,300			24,30	30	NTN
T-L860048/L860010	330,200	415,925	47,625	34,925	47,625	13,30	29	NTN
T-L860049/L860010	330,200	415,925	47,625	34,925	47,625	13,30	29	NTN
4T-861	101,600		57,531			4,31	29	NTN
4T-861/854	101,600	190,500	57,531	44,450	57,531	7,00	29	NTN
4T-NA861/854D	101,600	190,500	57,150			6,53	30	NTN
4T-864	95,250		57,531			4,75	29	NTN
L865547/L865512	381,000	479,425	47,625	34,925	49,212	20,00	29	NTN
4T-M86610		64,292		16,670		0,13	29	NTN
4T-M86643	25,400		21,433			0,24	29	NTN
4T-M86643/M86610	25,400	64,292	21,433	16,670	21,433	0,37	29	NTN
4T-M86647	28,575		21,433			0,22	29	NTN
4T-M86647/M86610	28,575	64,292	21,433	16,670	21,433	0,35	29	NTN
4T-M86649	30,162		21,433			0,21	29	NTN
4T-M86649/M86610	30,162	64,292	21,433	16,670	21,433	0,34	29	NTN
86650/86100	165,100	254,000	46,038	33,338	46,038	7,43	29	NTN





Reference	D		B	C	T	Kg	Brands	
	d	D	B	C	T			
LM869448/LM869410A	431,800	571,500	74,612	52,388	74,612	21,76	29	NTN
E-LM869448/LM869410D+A	431,800	571,500	155,575			97,46	30	NTN
T-LM869448/LM869410	431,800	571,500	74,612	52,388	74,612	45,70	29	NTN
T-LM869448/LM869410D+A	431,800	571,500	155,575			95,30	30	NTN
E-LM869449D/LM869410/LM869410D	431,800	571,500	279,400			192,00	32	NTN
T-LM869449D/LM869410/LM869410D	431,800	571,500	279,400			193,00	32	NTN
T-LM869449D/LM869410+A	431,800	571,500	133,350			92,10	31	NTN
87737/87111	187,325	282,575	47,625	36,512	50,800	9,73	29	NTN
T-87737/87111	187,325	282,575	47,625	36,512	50,800	10,90	29	NTN
T-87737/87112D+A	187,325	282,575	107,950			21,10	30	NTN
87750/87111	190,500	282,575	47,625	36,512	50,800	9,39	29	NTN
T-87750/87111	190,500	282,575	47,625	36,512	50,800	10,60	29	NTN
T-87750/87112D+A	190,500	282,575	107,950			20,60	30	NTN
87762/87111	193,675	282,575	47,625	36,512	50,800	9,00	29	NTN
T-87762/87111	193,675	282,575	47,625	36,512	50,800	10,30	29	NTN
T-87762/87112D+A	193,675	282,575	107,950			20,00	30	NTN
L879946/L879910	609,396	762,000	92,075	71,438	95,250	95,70	29	NTN
L879947/L879910	609,600	762,000	92,075	71,438	95,250	95,60	29	NTN
4T-M88010		68,262		17,462		0,14	29	NTN
4T-M88040	28,575		22,225			0,27	29	NTN
4T-M88040/M88010	28,575	68,262	22,225	17,462	22,225	0,42	29	NTN
4T-M88043	30,162		22,225			0,26	29	NTN
4T-M88043/M88010	30,162	68,262	22,225	17,462	22,225	0,40	29	NTN
4T-M88046	31,750		22,225			0,25	29	NTN
4T-M88046/M88010	31,750	68,262	22,225	17,462	22,225	0,39	29	NTN
4T-M88047	33,338		22,225			0,22	29	NTN
4T-M88047/M88010	33,338	68,262	22,225	17,462	22,225	0,37	29	NTN
4T-M88048	33,338		22,225			0,23	29	NTN
4T-M88048/M88010	33,338	68,262	22,225	17,462	22,225	0,38	29	NTN
CRO-8806	440,000	650,000	460,000			600,00	32	NTN
E-CRO-8806	440,000	650,000	460,000			600,00	32	NTN
CRO-8807	440,000	650,000	355,000			400,00	32	NTN
E-CRO-8807	440,000	650,000	355,000			400,00	32	NTN
CRD-8808	440,000	650,000	155,000			163,00	31	NTN
CRO-8808	440,000	635,000	470,000			498,00	32	NTN
CRD-8822	440,000	730,000	290,000			513,00	31	NTN
E-CRO-8823LL	440,000	620,000	454,000			421,00	32	NTN
E-CRO-8830LL	440,000	590,000	480,000			358,00	32	NTN
CRO-8830LL	440,000	590,000	480,000			358,00	32	NTN
CRO-8832LL	440,000	620,000	454,000			426,00	32	NTN
E-CRO-8839	440,000	620,000	454,000			430,00	32	NTN
4T-HM88510		73,025		23,020		0,24	29	NTN
4T-JHM88540/JHM88513	30,000	72,000	27,783	23,020	29,370	0,61	29	NTN
4T-HM88542	31,750		27,783			0,38	29	NTN
4T-HM88542/HM88510	31,750	73,025	27,783	23,020	29,370	0,61	29	NTN
4T-HM88542/HM88512	31,750	73,812	27,783	23,020	29,370	0,64	29	NTN
4T-HM88547	33,338		27,783			0,36	29	NTN
4T-HM88547/HM88510	33,338	73,025	27,783	23,020	29,370	0,60	29	NTN
4T-HM88610		72,258		19,842		0,19	29	NTN
4T-HM88630	25,400		25,400			0,39	29	NTN
4T-HM88648	35,717		25,400			0,29	29	NTN
4T-HM88648/HM88610	35,717	72,233	25,400	19,842	25,400	0,48	29	NTN

Reference						Kg	?	Brands
	d	D	B	C	T			
4T-HM88648/HM88611AS	35,717	72,626	25,400	19,842	25,400	0,48	29	NTN
4T-HM88649	34,925		25,400			0,30	29	NTN
4T-HM88649/HM88610	34,925	72,233	25,400	19,842	25,400	0,49	29	NTN
LL889049/LL889010	1 270,000	1 435,100	65,088	47,625	69,850	666,00	29	NTN
LL889049/LL889010D+A	1 270,000	1 435,100	146,050			285,00	30	NTN
4T-892		228,625		44,450		3,13	29	NTN
4T-HM89210		79,375		22,664		0,25	29	NTN
4T-HM89249	36,512		28,829			0,43	29	NTN
4T-HM89249/HM89210	36,512	79,375	28,829	22,664	29,370	0,69	29	NTN
4T-HM89410		76,225		23,020		0,25	29	NTN
4T-HM89411		76,200		23,020		0,26	29	NTN
4T-HM89440/HM89410	31,750	76,200	28,575	23,020	29,370	0,69	29	NTN
4T-HM89443	33,338		28,575			0,41	29	NTN
4T-HM89443/HM89410	33,338	76,200	28,575	23,020	29,370	0,66	29	NTN
4T-HM89444	33,338		28,575			0,40	29	NTN
4T-HM89444/HM89410	33,338	76,200	28,575	23,020	29,370	0,67	29	NTN
4T-HM89446	34,925		28,575			0,39	29	NTN
4T-HM89446/HM89410	34,925	76,200	28,575	23,020	29,370	0,64	29	NTN
4T-HM89448	36,512		28,575			0,37	29	NTN
4T-HM89448/HM89410	36,512	76,200	28,575	23,020	29,370	0,63	29	NTN
4T-HM89449	36,512		28,575			0,37	29	NTN
4T-HM89449/HM89410	36,512	76,200	28,575	23,020	29,370	0,62	29	NTN
4T-HM89449/HM89411	36,512	76,200	28,575	23,020	29,370	0,63	29	NTN
4T-896	136,525		57,150			5,94	29	NTN
4T-896/892	136,525	228,600	57,150	44,450	57,150	9,07	29	NTN
4T-898	139,700		57,150			5,63	29	NTN
4T-898/892	139,700	228,600	57,150	44,450	57,150	8,76	29	NTN
CRD-9011	450,000	720,000	300,000			483,00	31	NTN
E-CRO-9012	448,000	635,000	464,000			485,00	32	NTN
4T-HM903210		95,250		22,225		0,39	29	NTN
4T-HM903244	41,275		28,300			0,65	29	NTN
4T-HM903245	41,275		28,575			0,65	29	NTN
4T-HM903245/HM903210	41,275	95,250	28,575	22,225	30,958	1,03	29	NTN
4T-HM903247	44,450		28,300			0,61	29	NTN
4T-HM903248/HM903210	44,988	95,250	28,575	22,225	30,958	0,98	29	NTN
4T-HM903249	44,450		28,575			0,61	29	NTN
4T-HM903249/HM903210	44,450	95,250	28,575	22,225	30,958	0,99	29	NTN
4T-M903310		92,075		16,670		0,24	29	NTN
4T-M903345	41,275		23,812			0,51	29	NTN
4T-M903345/M903310	41,275	92,075	23,812	16,670	26,195	0,76	29	NTN
4T-90381	96,838		46,038			3,90	29	NTN
4T-90381/90744	96,838	188,912	46,038	31,750	50,800	5,67	29	NTN
4T-HM905810		104,986		23,368		0,49	29	NTN
4T-HM905843	45,000		31,750			0,85	29	NTN
4T-HM905843/HM905810	45,000	104,986	31,750	23,368	32,512	1,34	29	NTN
4T-HM907614		111,125		20,638		0,50	29	NTN
4T-HM907643	50,800		28,575			0,85	29	NTN
4T-HM907643/HM907614	50,800	111,125	28,575	20,638	30,162	1,36	29	NTN
CRTX9102	457,200	609,600	63,500			56,60	38	NTN
CRO-9107LL	457,200	596,900	276,225			192,00	32	NTN
CR-9111	457,200	573,088	74,613	57,150	74,613	43,00	29	NTN
4T-HM911210		130,175		23,812		0,68	29	NTN

Reference	d		D		B	C	T	Kg	Brands	
4T-HM911242	53,975				33,338			1,35	29	NTN
4T-HM911242/HM911210	53,975	130,175			33,338	23,812	36,512	2,27	29	NTN
4T-HM911244	60,000				30,924			1,35	29	NTN
4T-HM911244/HM911210	60,000	130,200			30,924	22,650	34,300	2,02	29	NTN
4T-HM911245	60,325				33,338			1,42	29	NTN
4T-HM911245/HM911210	60,325	130,175			33,338	23,812	36,512	2,12	29	NTN
EE911600/912400	406,400	609,600			84,138	60,325	92,075	91,30	29	NTN
EE911600/912401D+A	406,400	609,600			187,325			169,00	30	NTN
EE911603D/912400/912401D	406,400	609,600			309,562			332,00	32	NTN
E-EE911603D/912400/912401D	406,400	609,600			309,562			332,00	32	NTN
4T-9121		152,400				31,750		1,28	29	NTN
4T-H913810		146,050				25,400		0,90	29	NTN
4T-H913840	60,000				39,688			2,32	29	NTN
4T-H913840/H913810	60,000	146,050			39,688	25,400	41,275	3,22	29	NTN
4T-H913842	61,912				39,688			2,27	29	NTN
4T-H913842/H913810	61,912	146,050			39,688	25,400	41,275	3,17	29	NTN
4T-H913849	69,850				39,688			1,98	29	NTN
4T-H913849/H913810	69,850	146,050			39,688	25,400	41,275	2,88	29	NTN
4T-H916642/H916610	69,987	176,212			53,183	36,512	54,770	6,40	29	NTN
4T-H917840/H917810	76,200	180,975			53,183	35,720	53,975	6,60	29	NTN
4T-9185	68,262				46,038			2,49	29	NTN
4T-9185/9121	68,262	152,400			46,038	31,750	47,625	3,77	29	NTN
CRD-9202	460,000	618,000			150,000			126,00	31	NTN
CRD-9203	458,000	830,500			377,000			890,00	31	NTN
CRD-9204	460,000	860,000			420,000			1 120,00	31	NTN
CRD-9211	460,000	618,000			150,000			120,00	31	NTN
EE921150D/921875/921876D	292,100	476,250			296,047			208,00	32	NTN
E-EE921150D/921875/921876D	292,100	476,250			296,047			208,00	32	NTN
CRD-9214	460,000	720,000			250,000			388,00	31	NTN
CRD-9218	460,000	618,000			150,000			115,00	31	NTN
T-EE923095/923175G2	241,300	444,500			100,012	76,200	101,600	68,00	29	NTN
T-EE923095/923176DG2+A	241,300	444,500			209,550			128,00	30	NTN
4T-HH923649/HH923610	101,600	250,825			73,025	50,800	76,200	17,12	29	NTN
4T-H924010		214,312				39,688		2,50	29	NTN
4T-H924045/H924010	111,125	214,312			52,388	39,688	55,562	8,18	29	NTN
4T-H924045/H924010D	111,125	214,312			52,388	107,950	115,888	17,30	30	NTN
E-HH924349/HH924310D+A	111,125	241,300			158,750			31,80	30	NTN
4T-HH924349/HH924310D+A	111,125	241,300			158,750			32,00	30	NTN
4T-HM926710		228,600				38,100		2,81	29	NTN
4T-HH926710		273,050				53,975		7,00	29	NTN
4T-HM926740	114,300				49,428			6,95	29	NTN
4T-HM926740/HM926710	114,300	228,600			49,428	38,100	53,975	9,76	29	NTN
4T-HM926740/HM926710D+A	114,300	228,600			115,888			21,10	30	NTN
T-HH926744/HH926710	114,300	273,050			82,550	53,975	82,550	22,20	29	NTN
T-HH926744/HH926716	114,300	279,400			82,550	53,975	82,550	23,50	29	NTN
4T-HM926747	127,000				49,428			6,02	29	NTN
4T-HM926747/HM926710	127,000	228,600			49,428	38,100	53,975	8,70	29	NTN
4T-HH926749/HH926710	120,650	273,050			82,550	53,975	82,550	22,00	29	NTN
4T-HM926749/HM926710D+A	127,792	228,600			115,888			18,70	30	NTN
T-HH926749/HH926710	120,650	273,050			82,550	53,975	82,550	21,70	29	NTN
4T-9278/9220	68,262	161,925			46,038	31,750	49,212	4,64	29	NTN
4T-9285/9220D+A	76,200	161,925			105,562			9,08	30	NTN

Reference						Kg	?	Brands
	d	D	B	C	T			
4T-930		206,375		53,975		3,23	29	NTN
EE931170D/931250/931251XDG2	431,800	635,000	355,600			402,00	32	NTN
4T-932		212,725		53,975		4,60	29	NTN
T-HH932132/HH932110	127,000	304,800	82,550	57,150	88,900	32,80	29	NTN
T-HH932145/HH932110	146,050	304,800	82,550	57,150	88,900	30,60	29	NTN
T-HH932145/HH932115	146,050	311,150	82,550	57,150	88,900	32,20	29	NTN
4T-936	107,950		66,675			6,54	29	NTN
4T-936/932	107,950	212,725	66,675	53,975	66,675	10,70	29	NTN
H936340/H936310DF	155,575	330,200	171,450			62,90	30	NTN
T-H936340/H936310	155,575	330,200	79,375	53,975	85,725	34,90	29	NTN
T-H936340/H936316	155,575	342,900	79,375	53,975	85,725	38,40	29	NTN
H936349/H936310DF	168,275	330,200	171,450			62,50	30	NTN
T-H936349/H936310	168,275	330,200	79,375	53,975	85,725	33,20	29	NTN
T-93708/93125	180,000	317,500	63,500	46,038	63,500	19,00	29	NTN
T-93750/93125	190,500	317,500	63,500	46,038	63,500	17,90	29	NTN
T-93750/93127D+A	190,500	317,500	146,050			41,20	30	NTN
93775/93125	196,850	317,500	63,500	46,038	63,500	18,70	29	NTN
4T-9378/9321	76,200	171,450	50,800	31,750	49,212	5,26	29	NTN
T-93787/93125	200,025	317,500	63,500	46,038	63,500	18,30	29	NTN
T-93787/93727D+A	200,025	317,500	146,050			38,80	30	NTN
93787/J93129A	200,025	319,960	63,500	46,038	63,500	18,80	29	NTN
4T-938	114,300		66,675			6,00	29	NTN
4T-938/932	114,300	212,725	66,675	53,975	66,675	10,10	29	NTN
4T-938/932D+A	114,300	212,725	142,875			20,00	30	NTN
T-93800/93125	203,200	317,500	63,500	46,038	63,500	16,50	29	NTN
NA93800/93127D	203,200	317,500	146,050			38,27	30	NTN
T-93800/93127D+A	203,200	317,500	146,050			37,10	30	NTN
T-93800D/93125+A	203,200	317,500	123,825			36,30	31	NTN
T-93825/93125	209,550	317,500	63,500	46,038	63,500	15,80	29	NTN
T-93825/93127D+A	209,550	317,500	146,050			36,30	30	NTN
4T-9386H/9321	84,138	171,450	46,038	31,750	49,212	4,67	29	NTN
CRD-9404	470,000	720,000	216,000			315,00	31	NTN
4T-941	101,600		66,675			7,10	29	NTN
4T-941/932	101,600	212,725	66,675	53,975	66,675	11,20	29	NTN
EE941205/941950A	304,800	495,300	74,612	53,975	76,200	55,80	29	NTN
T-94649/94113	165,100	288,925	63,500	47,625	63,500	17,10	29	NTN
T-94649/94114D+A	165,100	288,925	142,875			35,10	30	NTN
T-94687/94113	174,625	288,925	63,500	47,625	63,500	14,70	29	NTN
T-94687/94114D+A	174,625	288,925	142,875			33,10	30	NTN
T-94700/94113	177,800	288,925	63,500	47,625	63,500	14,40	29	NTN
NA94700/94114D	177,800	288,925	142,875			52,51	30	NTN
T-94700/94114D+A	177,800	288,925	142,875			32,40	30	NTN
T-94706D/94113+A	177,800	288,925	123,825			31,60	30	NTN
E-HH949549/HH949510D+A	228,600	488,950	254,000			200,60	30	NTN
T-HH949549/HH949510DG2+A	228,600	488,950	254,000			207,00	30	NTN
T-HH949549/HH949510G2	228,600	488,950	111,125	73,025	123,825	111,00	29	NTN
CRO-9501	475,000	660,000	450,000			465,00	32	NTN
E-CRO-9501	475,000	660,000	450,000			465,00	32	NTN
E-CRO-9505	475,000	620,000	380,000			294,00	32	NTN
HH953749/HH953710	254,000	533,400	120,650	77,788	133,350	141,00	29	NTN
HH953749/HH953710D+A	254,000	533,400	276,225			266,00	30	NTN
4T-95475	120,650		63,500			8,56	29	NTN

Reference	d		D		B	C	T	Kg	Brands
	d	D	B	C	T				
4T-95475/95925	120,650	234,950	63,500	49,212	63,500	12,60	29	NTN	
4T-95500	127,000		63,500			7,95	29	NTN	
4T-95500/95925	127,000	234,950	63,500	49,212	63,500	11,96	29	NTN	
NA95500/95927D	127,000	234,950	142,875			24,60	30	NTN	
4T-95500/95927D+A	127,000	234,950	142,875			26,30	30	NTN	
4T-95525	133,350		63,500			7,27	29	NTN	
4T-95525/95925	133,350	234,950	63,500	49,212	63,500	11,30	29	NTN	
4T-95525/95927D+A	133,350	234,950	142,875			23,60	30	NTN	
4T-95925		234,950		49,212		4,05	29	NTN	
E-M959442/M959410	304,800	499,948	79,375	53,975	101,600	67,00	29	NTN	
CRO-9602	480,000	700,000	390,000			436,00	32	NTN	
E-CRO-9602	480,000	700,000	390,000			436,00	32	NTN	
CRD-9603	480,000	690,000	180,000			224,00	31	NTN	
CRD-9605	481,228	615,950	158,750			108,00	31	NTN	
E-CRO-9609	480,000	700,000	390,000			511,00	32	NTN	
CRD-9609	480,000	689,500	180,000			223,00	31	NTN	
CRO-9610LL	479,425	679,450	495,300			565,00	32	NTN	
CRD-9612	479,425	679,450	238,125			261,00	31	NTN	
CRO-9612	480,000	678,000	494,000			554,00	32	NTN	
E-CRD-9613	482,000	632,000	520,000			443,00	31	NTN	
4T-LM961511		457,098		47,625		9,39	29	NTN	
4T-LM961548	342,900		63,500			19,80	29	NTN	
LM961548/LM961511	342,900	457,098	63,500	47,625	68,262	30,00	29	NTN	
LM961548/LM961511D+A	342,900	457,098	142,875			57,10	30	NTN	
H961649/H961610DG2+A	317,500	622,300	304,800			382,00	30	NTN	
H961649/H961610G2	317,500	622,300	131,762	82,550	147,638	203,00	29	NTN	
E-CRO-9619	480,000	700,000	390,000			510,00	32	NTN	
T-96900/96140	228,600	355,600	66,675	47,625	68,262	24,30	29	NTN	
T-96900/96140D+A	228,600	355,600	152,400			49,40	30	NTN	
T-96925/96140	234,950	355,600	66,675	47,625	68,262	22,50	29	NTN	
T-96925/96140D+A	234,950	355,600	152,400			47,50	30	NTN	
CRD-9704	482,600	733,500	200,000			301,00	31	NTN	
CRD-9708	482,600	615,950	163,750			121,00	31	NTN	
CRD-9709	482,600	615,950	158,750			108,00	31	NTN	
EE971354/972100	342,900	533,400	76,200	50,800	76,200	55,60	29	NTN	
EE971354/972102D	342,900	533,400	165,100			83,90	30	NTN	
EE971354/972102D+A	342,900	533,400	165,100			120,00	30	NTN	
EE971355D/972100/972103D	342,900	533,400	307,985			252,00	32	NTN	
E-EE971355D/972100/972103D	342,900	533,400	307,985			252,00	32	NTN	
E-CRD-9716D2	482,600	615,950	500,000			355,00	31	NTN	
CRO-9725LL	482,600	615,950	330,200			225,00	32	NTN	
E-CRO-9737	482,600	615,950	330,200			239,00	32	NTN	
4T-97500/97900	127,000	228,600	49,428	38,100	53,975	8,43	29	NTN	
4T-98316	80,000		49,212			5,72	29	NTN	
4T-98350	88,900		49,212			5,08	29	NTN	
4T-98350/98788	88,900	200,000	49,212	34,925	52,761	7,64	29	NTN	
4T-98350/98788DF	88,900	200,000	105,522			14,90	30	NTN	
4T-98400	101,600		49,212			4,53	29	NTN	
4T-98400/98788	101,600	200,000	49,212	34,925	52,761	6,91	29	NTN	
4T-98400/98789D+A	101,600	200,025	115,888			15,10	30	NTN	
4T-98788		200,000		34,925		2,37	29	NTN	
4T-99100		254,000		47,625		4,30	29	NTN	

Reference						Kg	 Brands	
	d	D	B	C	T			
4T-99550	139,700		66,675			5,58	29	NTN
4T-99575/99100	146,050	254,000	66,675	47,625	66,675	13,50	29	NTN
4T-99600	152,400		66,675			8,52	29	NTN
4T-99600/99100	152,400	254,000	66,675	47,625	66,675	12,78	29	NTN
4T-99600/99102CD	152,400	254,000	149,225			27,46	30	NTN
4T-NA99600/99102D	152,400	254,000	142,875			27,40	30	NTN
9974D/9920/9920D	216,103	330,200	263,525			82,10	30	NTN
4T-T2ED050	50,000	100,000	35,000	30,000	36,000	1,31	29	NTN
4T-T2EE040	40,000	85,000	32,500	28,000	33,000	0,91	29	NTN
4T-T2EE060	60,000	115,000	39,000	33,000	40,000	1,86	29	NTN
4T-T4CB100	100,000	145,000	22,500	17,500	24,000	1,11	29	NTN
T4CB 120	120,000	170,000	25,000	19,500	27,000	1,69	29	SNR
4T-T4CB120	120,000	170,000	25,000	19,500	27,000	1,69	29	NTN
4T-T4CB140	140,000	195,000	27,000	21,000	29,000	2,33	29	NTN
4T-T7FC045	45,000	95,000	26,500	20,000	29,000	0,90	29	NTN
4T-T7FC050	50,000	105,000	29,000	22,000	32,000	1,21	29	NTN
4T-T7FC055	55,000	115,000	31,000	23,500	34,000	1,54	29	NTN
4T-T7FC060	60,000	125,000	33,500	26,000	37,000	1,99	29	NTN
4T-T7FC065	65,000	130,000	33,500	26,000	37,000	2,11	29	NTN
4T-T7FC070	70,000	140,000	35,500	27,000	39,000	2,57	29	NTN
4T-T7FC085	85,000	170,000	45,000	33,000	48,000	4,73	29	NTN
4T-T7FC095	95,000	180,000	45,000	33,000	49,000	5,21	29	NTN



Spherical roller bearing



Pendelrollenlager



Rodamientos de rodillos a rótula



Сферические роликоподшипники



Roulements à rotule sur rouleaux



Cuscinetti orientabili a rulli



Rolamentos autocompensadores de rolos



Łożyska baryłkowe



Classification by references – Classification par références
Klassifizierung nach Referenzen – Classificazione per codice
Clasificación por referencias – Classificação por referências
Классификация по кодам – Klasyfikacja wg numerów katalogowych

Reference	d	D	B	Kg	?	Brands
20208EG15	40,000	80,000	18,000	0,37	33	SNR
21305V	25,000	62,000	17,000	0,26	33	SNR
21305VK	25,000	62,000	17,000	0,26	33	SNR
21306V	30,000	72,000	19,000	0,39	33	SNR
21306VK	30,000	72,000	19,000	0,39	33	SNR
21307V	35,000	80,000	21,000	0,53	33	SNR
21307VK	35,000	80,000	21,000	0,52	33	SNR
21308V	40,000	90,000	23,000	0,73	33	SNR
21308VK	40,000	90,000	23,000	0,71	33	SNR
21309V	45,000	100,000	25,000	0,97	33	SNR
21309VK	45,000	100,000	25,000	0,96	33	SNR
21310V	50,000	110,000	27,000	1,28	33	SNR
21310VK	50,000	110,000	27,000	1,26	33	SNR
21311V	55,000	120,000	29,000	1,63	33	SNR
21311VK	55,000	120,000	29,000	1,60	33	SNR
21312V	60,000	130,000	31,000	1,98	33	SNR
21312VK	60,000	130,000	31,000	1,96	33	SNR
21313V	65,000	140,000	33,000	2,44	33	SNR
21313VK	65,000	140,000	33,000	2,39	33	SNR
21314V	70,000	150,000	35,000	3,01	33	SNR
21314VK	70,000	150,000	35,000	2,97	33	SNR
21315V	75,000	160,000	37,000	3,59	33	SNR
21315VK	75,000	160,000	37,000	3,54	33	SNR
21316V	80,000	170,000	39,000	4,24	33	SNR
21316VK	80,000	170,000	39,000	4,19	33	SNR
21317VM	85,000	180,000	41,000	5,28	33	SNR
21317VMK	85,000	180,000	41,000	5,20	33	SNR
21318VM	90,000	190,000	43,000	6,15	33	SNR
21318VMK	90,000	190,000	43,000	6,06	33	SNR
22205EA	25,000	52,000	18,000	0,18	33	SNR
22205EAKW33	25,000	52,000	18,000	0,18	33	SNR
22205EAW33	25,000	52,000	18,000	0,18	33	SNR
22205EG15W33	25,000	52,000	18,000	0,17	33	SNR
22205EMKW33	25,000	52,000	18,000	0,18	33	SNR
22205EMW33	25,000	52,000	18,000	0,18	33	SNR
22206EA	30,000	62,000	20,000	0,29	33	SNR
22206EAKW33	30,000	62,000	20,000	0,28	33	SNR
22206EAW33	30,000	62,000	20,000	0,28	33	SNR
22206EG15KW33	30,000	62,000	20,000	0,27	33	SNR
22206EG15W33	30,000	62,000	20,000	0,27	33	SNR
22206EMKW33	30,000	62,000	20,000	0,28	33	SNR
22206EMW33	30,000	62,000	20,000	0,29	33	SNR
22207EAKW33	35,000	72,000	23,000	0,44	33	SNR
22207EAW33	35,000	72,000	23,000	0,45	33	SNR

Reference	d	D	B	Kg	?	Brands
22207EG15KW33	35,000	72,000	23,000	0,42	33	SNR
22207EG15W33	35,000	72,000	23,000	0,43	33	SNR
22207EMKW33	35,000	72,000	23,000	0,45	33	SNR
22207EMW33	35,000	72,000	23,000	0,46	33	SNR
22208EAKW33	40,000	80,000	23,000	0,53	33	SNR
22208EAW33	40,000	80,000	23,000	0,53	33	SNR
22208EG15W33	40,000	80,000	23,000	0,52	33	SNR
22208EM	40,000	80,000	23,000	0,55	33	SNR
22208EMKW33	40,000	80,000	23,000	0,57	33	SNR
22208EMW33	40,000	80,000	23,000	0,54	33	SNR
22209EAKW33	45,000	85,000	23,000	0,57	33	SNR
22209EAW33	45,000	85,000	23,000	0,58	33	SNR
22209EG15W33	45,000	85,000	23,000	0,56	33	SNR
22209EM	45,000	85,000	23,000	0,60	33	SNR
22209EMKW33	45,000	85,000	23,000	0,58	33	SNR
22209EMW33	45,000	85,000	23,000	0,59	33	SNR
22210EAKW33	50,000	90,000	23,000	0,62	33	SNR
22210EAW33	50,000	90,000	23,000	0,62	33	SNR
22210EG15KW33	50,000	90,000	23,000	2,80	33	SNR
22210EG15W33	50,000	90,000	23,000	0,61	33	SNR
22210EMKW33	50,000	90,000	23,000	0,63	33	SNR
22210EMW33	50,000	90,000	23,000	0,64	33	SNR
22211EA	55,000	100,000	25,000	0,83	33	SNR
22211EAKW33	55,000	100,000	25,000	0,83	33	SNR
22211EAW33	55,000	100,000	25,000	0,84	33	SNR
22211EG15KW33	55,000	100,000	25,000	0,80	33	SNR
22211EMKW33	55,000	100,000	25,000	0,84	33	SNR
22211EMW33	55,000	100,000	25,000	0,86	33	SNR
22212EAKW33	60,000	110,000	28,000	1,14	33	SNR
22212EAW33	60,000	110,000	28,000	1,16	33	SNR
22212EG15W33	60,000	110,000	28,000	1,13	33	SNR
22212EMKW33	60,000	110,000	28,000	1,16	33	SNR
22212EMW33	60,000	110,000	28,000	1,17	33	SNR
22213EA	65,000	120,000	31,000	1,56	33	SNR
22213EAKW33	65,000	120,000	31,000	1,51	33	SNR
22213EAW33	65,000	120,000	31,000	1,55	33	SNR
22213EG15KW33	65,000	120,000	31,000	1,39	33	SNR
22213EG15W33	65,000	120,000	31,000	1,45	33	SNR
22213EMKW33	65,000	120,000	31,000	1,54	33	SNR
22213EMW33	65,000	120,000	31,000	1,57	33	SNR
22214EAKW33	70,000	125,000	31,000	1,57	33	SNR
22214EAW33	70,000	125,000	31,000	1,63	33	SNR
22214EG15KW33	70,000	125,000	31,000	1,45	33	SNR
22214EG15W33	70,000	125,000	31,000	1,52	33	SNR
22214EMKW33	70,000	125,000	31,000	1,64	33	SNR
22214EMW33	70,000	125,000	31,000	1,67	33	SNR
22215EAKW33	75,000	130,000	31,000	1,66	33	SNR
22215EAW33	75,000	130,000	31,000	1,70	33	SNR
22215EG15KW33	75,000	130,000	31,000	1,53	33	SNR
22215EG15W33	75,000	130,000	31,000	1,62	33	SNR
22215EMKW33	75,000	130,000	31,000	1,71	33	SNR
22215EMW33	75,000	130,000	31,000	1,75	33	SNR
22216EAKW33	80,000	140,000	33,000	2,07	33	SNR
22216EAW33	80,000	140,000	33,000	2,11	33	SNR

Reference	d	D	B	Kg	Brands
22216EF800	80,000	140,000	33,000	2,15	33 SNR
22216EG15KW33	80,000	140,000	33,000	1,96	33 SNR
22216EG15W33	80,000	140,000	33,000	2,00	33 SNR
22216EMKW33	80,000	140,000	33,000	2,11	33 SNR
22216EMW33	80,000	140,000	33,000	2,16	33 SNR
22217EAKW33	85,000	150,000	36,000	2,60	33 SNR
22217EAW33	85,000	150,000	36,000	2,65	33 SNR
22217EG15KW33	85,000	150,000	36,000	2,47	33 SNR
22217EG15W33	85,000	150,000	36,000	2,09	33 SNR
22217EMKW33	85,000	150,000	36,000	2,69	33 SNR
22217EMW33	85,000	150,000	36,000	2,75	33 SNR
22218EAKW33	90,000	160,000	40,000	3,30	33 SNR
22218EAW33	90,000	160,000	40,000	3,38	33 SNR
22218EF800	90,000	160,000	40,000	3,28	33 SNR
22218EG15KW33	90,000	160,000	40,000	3,19	33 SNR
22218EG15W33	90,000	160,000	40,000	3,27	33 SNR
22218EMKW33	90,000	160,000	40,000	3,42	33 SNR
22218EMW33	90,000	160,000	40,000	3,50	33 SNR
22219EA	95,000	170,000	43,000	3,99	33 SNR
22219EAKW33	95,000	170,000	43,000	3,93	33 SNR
22219EAW33	95,000	170,000	43,000	4,03	33 SNR
22219EMKW33	95,000	170,000	43,000	4,06	33 SNR
22219EMW33	95,000	170,000	43,000	4,16	33 SNR
22220EA	100,000	180,000	46,000	5,01	33 SNR
22220EAKW33	100,000	180,000	46,000	4,84	33 SNR
22220EAW33	100,000	180,000	46,000	4,96	33 SNR
22220EF800	100,000	180,000	46,000	5,08	33 SNR
22220EG15KW33	100,000	180,000	46,000	4,71	33 SNR
22220EG15W33	100,000	180,000	46,000	4,80	33 SNR
22220EMKW33	100,000	180,000	46,000	5,02	33 SNR
22220EMW33	100,000	180,000	46,000	5,11	33 SNR
22222EAKW33	110,000	200,000	53,000	6,99	33 SNR
22222EAW33	110,000	200,000	53,000	7,12	33 SNR
22222EG15KW33	110,000	200,000	53,000	6,80	33 SNR
22222EG15W33	110,000	200,000	53,000	6,80	33 SNR
22222EMKW33	110,000	200,000	53,000	7,18	33 SNR
22222EMW33	110,000	200,000	53,000	7,35	33 SNR
22224EAKW33	120,000	215,000	58,000	8,70	33 SNR
22224EAW33	120,000	215,000	58,000	8,92	33 SNR
22224EMKW33	120,000	215,000	58,000	8,96	33 SNR
22224EMW33	120,000	215,000	58,000	9,16	33 SNR
22226EAKW33	130,000	230,000	64,000	10,74	33 SNR
22226EAW33	130,000	230,000	64,000	11,00	33 SNR
22226EMKW33	130,000	230,000	64,000	10,90	33 SNR
22226EMW33	130,000	230,000	64,000	11,30	33 SNR
22228EAKW33	140,000	250,000	68,000	13,60	33 SNR
22228EAW33	140,000	250,000	68,000	13,92	33 SNR
22228EMKW33	140,000	250,000	68,000	14,07	33 SNR
22228EMW33	140,000	250,000	68,000	14,42	33 SNR
22230EAKW33	150,000	270,000	73,000	17,35	33 SNR
22230EAW33	150,000	270,000	73,000	17,75	33 SNR
22230EMKW33	150,000	270,000	73,000	17,89	33 SNR
22230EMW33	150,000	270,000	73,000	18,28	33 SNR

Reference	d	D	B	Kg	Brands
22232EAKW33	160,000	290,000	80,000	21,93	33 SNR
22232EAW33	160,000	290,000	80,000	22,45	33 SNR
22232EMKW33	160,000	290,000	80,000	22,85	33 SNR
22232EMW33	160,000	290,000	80,000	23,21	33 SNR
22234EMKW33	170,000	310,000	86,000	31,85	33 SNR
22234EMW33	170,000	310,000	86,000	32,75	33 SNR
22236EMKW33	180,000	320,000	86,000	32,57	33 SNR
22236EMW33	180,000	320,000	86,000	31,98	33 SNR
22238EMKW33	190,000	340,000	92,000	37,00	33 SNR
22238EMW33	190,000	340,000	92,000	36,65	33 SNR
22240EMKW33	200,000	360,000	98,000	46,57	33 SNR
22240EMW33	200,000	360,000	98,000	45,40	33 SNR
22244EMKW33	220,000	400,000	108,000	58,40	33 SNR
22244EMW33	220,000	400,000	108,000	65,25	33 SNR
22248B	240,000	440,000	120,000	88,00	33 NTN
22248BK	240,000	440,000	120,000	80,00	33 NTN
22248VMW33	240,000	440,000	120,000	93,30	33 SNR
22252B	260,000	480,000	130,000	113,00	33 NTN
22252BK	260,000	480,000	130,000	104,00	33 NTN
22252VMW33	260,000	480,000	130,000	35,50	33 SNR
22256B	280,000	500,000	130,000	112,00	33 NTN
22256BK	280,000	500,000	130,000	110,00	33 NTN
22260B	300,000	540,000	140,000	141,00	33 NTN
22260BK	300,000	540,000	140,000	138,00	33 NTN
22264B	320,000	580,000	150,000	168,00	33 NTN
22264BK	320,000	580,000	150,000	168,00	33 NTN
22308EAKW33	40,000	90,000	33,000	1,01	33 SNR
22308EAW33	40,000	90,000	33,000	1,03	33 SNR
22308EF800	40,000	90,000	33,000	1,04	33 SNR
22308EG15KW33	40,000	90,000	33,000	0,97	33 SNR
22308EG15W33	40,000	90,000	33,000	0,99	33 SNR
22308EMW33	40,000	90,000	33,000	1,05	33 SNR
22309EAKW33	45,000	100,000	36,000	1,35	33 SNR
22309EAW33	45,000	100,000	36,000	1,38	33 SNR
22309EF800	45,000	100,000	36,000	1,41	33 SNR
22309EF801	45,000	100,000	36,000	1,42	33 SNR
22309EG15KW33	45,000	100,000	36,000	1,30	33 SNR
22309EG15W33	45,000	100,000	36,000	1,33	33 SNR
22309EF800	45,000	100,000	36,000	1,37	33 SNR
22309EM	45,000	100,000	36,000	1,41	33 SNR
22309EMW33	45,000	100,000	36,000	1,40	33 SNR
22310EAKW33	50,000	110,000	40,000	1,80	33 SNR
22310EAW33	50,000	110,000	40,000	1,84	33 SNR
22310EF800	50,000	110,000	40,000	1,87	33 SNR
22310EF801	50,000	110,000	40,000	1,87	33 SNR
22310EG15KW33	50,000	110,000	40,000	1,72	33 SNR
22310EG15W33	50,000	110,000	40,000	1,77	33 SNR
22310EKF800	50,000	110,000	40,000	1,83	33 SNR
22310EMKW33	50,000	110,000	40,000	1,82	33 SNR
22310EMW33	50,000	110,000	40,000	1,87	33 SNR

Reference	d	D	B	Kg		Brands
22311BVS1	55,000	120,000	43,000	2,40	33	NTN
22311BVS2	55,000	120,000	43,000	2,30	33	NTN
22311EAKW33	55,000	120,000	43,000	2,28	33	SNR
22311EAW33	55,000	120,000	43,000	2,30	33	SNR
22311EF800	55,000	120,000	43,000	2,39	33	SNR
22311EF801	55,000	120,000	43,000	2,39	33	SNR
22311EG15KW33	55,000	120,000	43,000	2,23	33	SNR
22311EG15W33	55,000	120,000	43,000	2,28	33	SNR
22311EKF800	55,000	120,000	43,000	2,32	33	SNR
22311EKF801	55,000	120,000	43,000	2,34	33	SNR
22311EMKW33	55,000	120,000	43,000	2,33	33	SNR
22311EMW33	55,000	120,000	43,000	2,38	33	SNR
22312BVS1	60,000	130,000	46,000	3,06	33	NTN
22312BVS2	60,000	130,000	46,000	3,00	33	NTN
22312EAKW33	60,000	130,000	46,000	2,80	33	SNR
22312EAW33	60,000	130,000	46,000	2,87	33	SNR
22312EF800	60,000	130,000	46,000	2,95	33	SNR
22312EF801	60,000	130,000	46,000	2,95	33	SNR
22312EG15KW33	60,000	130,000	46,000	2,70	33	SNR
22312EG15W33	60,000	130,000	46,000	2,77	33	SNR
22312EKF800	60,000	130,000	46,000	2,89	33	SNR
22312EM	60,000	130,000	46,000	2,97	33	SNR
22312EMKW33	60,000	130,000	46,000	2,88	33	SNR
22312EMW33	60,000	130,000	46,000	2,95	33	SNR
22313BVS1	65,000	140,000	48,000	3,68	33	NTN
22313BVS2	65,000	140,000	48,000	3,65	33	NTN
22313EA	65,000	140,000	48,000	3,51	33	SNR
22313EAKW33	65,000	140,000	48,000	3,40	33	SNR
22313EAW33	65,000	140,000	48,000	3,48	33	SNR
22313EF800	65,000	140,000	48,000	3,55	33	SNR
22313EF801	65,000	140,000	48,000	3,53	33	SNR
22313EG15W33	65,000	140,000	48,000	3,32	33	SNR
22313EKF800	65,000	140,000	48,000	3,46	33	SNR
22313EMW33	65,000	140,000	48,000	3,54	33	SNR
22314EAKW33	70,000	150,000	51,000	4,19	33	SNR
22314EAW33	70,000	150,000	51,000	4,29	33	SNR
22314EF800	70,000	150,000	51,000	4,41	33	SNR
22314EF801	70,000	150,000	51,000	4,38	33	SNR
22314EG15KW33	70,000	150,000	51,000	4,00	33	SNR
22314EG15W33	70,000	150,000	51,000	4,13	33	SNR
22314EKF800	70,000	150,000	51,000	4,29	33	SNR
22314EMKW33	70,000	150,000	51,000	4,31	33	SNR
22314EMW33	70,000	150,000	51,000	4,39	33	SNR
22314UAVS2	70,000	150,000	51,000	4,37	33	NTN
22315EAKW33	75,000	160,000	55,000	5,10	33	SNR
22315EAW33	75,000	160,000	55,000	5,21	33	SNR
22315EF800	75,000	160,000	55,000	5,35	33	SNR
22315EF801	75,000	160,000	55,000	5,34	33	SNR
22315EG15KW33	75,000	160,000	55,000	4,89	33	SNR
22315EG15W33	75,000	160,000	55,000	5,01	33	SNR
22315EKF800	75,000	160,000	55,000	5,50	33	SNR
22315EM	75,000	160,000	55,000	5,53	33	SNR
22315EMKW33	75,000	160,000	55,000	5,24	33	SNR
22315EMW33	75,000	160,000	55,000	5,35	33	SNR
22315UAVS2	75,000	160,000	55,000	5,47	33	NTN
22316EAKW33	80,000	170,000	58,000	6,03	33	SNR
22316EAW33	80,000	170,000	58,000	6,17	33	SNR

Reference	d	D	B	Kg		Brands
22316EF800	80,000	170,000	58,000	6,35	33	SNR
22316EF801	80,000	170,000	58,000	6,38	33	SNR
22316EG15KW33	80,000	170,000	58,000	5,81	33	SNR
22316EG15W33	80,000	170,000	58,000	5,92	33	SNR
22316EKF800	80,000	170,000	58,000	6,24	33	SNR
22316EMK	80,000	170,000	58,000	6,29	33	SNR
22316EMKW33	80,000	170,000	58,000	6,25	33	SNR
22316EMW33	80,000	170,000	58,000	6,38	33	SNR
22316UAVS2	80,000	170,000	58,000	6,32	33	NTN
22317EAKW33	85,000	180,000	60,000	7,06	33	SNR
22317EAW33	85,000	180,000	60,000	7,22	33	SNR
22317EF800	85,000	180,000	60,000	7,39	33	SNR
22317EF801	85,000	180,000	60,000	7,39	33	SNR
22317EKF800	85,000	180,000	60,000	7,26	33	SNR
22317EMKW33	85,000	180,000	60,000	7,20	33	SNR
22317EMW33	85,000	180,000	60,000	7,41	33	SNR
22317UAVS2	85,000	180,000	60,000	7,32	33	NTN
22318EAKW33	90,000	190,000	64,000	8,28	33	SNR
22318EANW33	90,000	190,000	64,000	8,42	33	SNR
22318EAW33	90,000	190,000	64,000	8,44	33	SNR
22318EF800	90,000	190,000	64,000	8,62	33	SNR
22318EF801	90,000	190,000	64,000	8,67	33	SNR
22318EKF800	90,000	190,000	64,000	8,50	33	SNR
22318EKF801	90,000	190,000	64,000	8,50	33	SNR
22318EMK	90,000	190,000	64,000	8,53	33	SNR
22318EMKW33	90,000	190,000	64,000	8,51	33	SNR
22318EMW33	90,000	190,000	64,000	8,68	33	SNR
22318UAVS2	90,000	190,000	64,000	8,66	33	NTN
22319EAKW33	95,000	200,000	67,000	9,72	33	SNR
22319EAW33	95,000	200,000	67,000	9,95	33	SNR
22319EF800	95,000	200,000	67,000	10,18	33	SNR
22319EMKW33	95,000	200,000	67,000	9,98	33	SNR
22319EMW33	95,000	200,000	67,000	10,19	33	SNR
22319UAVS1	95,000	200,000	67,000	10,00	33	NTN
22319UAVS2	95,000	200,000	67,000	10,40	33	NTN
22320EAKW33	100,000	215,000	73,000	12,37	33	SNR
22320EAW33	100,000	215,000	73,000	12,61	33	SNR
22320EF800	100,000	215,000	73,000	13,03	33	SNR
22320EKF800	100,000	215,000	73,000	12,78	33	SNR
22320EMKW33	100,000	215,000	73,000	12,79	33	SNR
22320EMW33	100,000	215,000	73,000	13,06	33	SNR
22320UAVS2	100,000	215,000	73,000	12,90	33	NTN
22322EAKW33	110,000	240,000	80,000	16,81	33	SNR
22322EAW33	110,000	240,000	80,000	17,10	33	SNR
22322EF800	110,000	240,000	80,000	17,73	33	SNR
22322EF803	110,000	240,000	80,000	17,85	33	SNR
22322EKF800	110,000	240,000	80,000	17,39	33	SNR
22322EMKW33	110,000	240,000	80,000	17,37	33	SNR
22322EMW33	110,000	240,000	80,000	17,76	33	SNR
22322UAVS1	110,000	240,000	80,000	18,10	33	NTN
22322UAVS2	110,000	240,000	80,000	18,12	33	NTN
22324EAKW33	120,000	260,000	86,000	22,23	33	SNR
22324EAW33	120,000	260,000	86,000	22,40	33	SNR
22324EF800	120,000	260,000	86,000	23,00	33	SNR
22324EKF800	120,000	260,000	86,000	22,53	33	SNR
22324EM	120,000	260,000	86,000	23,21	33	SNR

Reference	d	D	B	Kg	Brands
22324EMK	120,000	260,000	86,000	22,75	33 SNR
22324EMKW33	120,000	260,000	86,000	22,52	33 SNR
22324EMW33	120,000	260,000	86,000	22,87	33 SNR
22324UAVS2	120,000	260,000	86,000	21,90	33 NTN
22326EAKW33	130,000	280,000	93,000	30,30	33 SNR
22326EAW33	130,000	280,000	93,000	30,80	33 SNR
22326EF800	130,000	280,000	93,000	31,60	33 SNR
22326EKF800	130,000	280,000	93,000	31,20	33 SNR
22326EMKW33	130,000	280,000	93,000	29,85	33 SNR
22326EMW33	130,000	280,000	93,000	31,64	33 SNR
22326UAVS1	130,000	280,000	93,000	28,32	33 NTN
22326UAVS2	130,000	280,000	93,000	28,32	33 NTN
22328EAKW33	140,000	300,000	102,000	35,60	33 SNR
22328EAW33	140,000	300,000	102,000	37,33	33 SNR
22328EF800	140,000	300,000	102,000	41,00	33 SNR
22328EKF800	140,000	300,000	102,000	40,60	33 SNR
22328EMKW33	140,000	300,000	102,000	34,72	33 SNR
22328EMW33	140,000	300,000	102,000	38,67	33 SNR
22328UAVS1	140,000	300,000	102,000	35,52	33 NTN
22328UAVS2	140,000	300,000	102,000	36,10	33 NTN
22330EF800	150,000	320,000	108,000	46,38	33 SNR
22330EF802	150,000	320,000	108,000	47,10	33 SNR
22330EKF800	150,000	320,000	108,000	41,40	33 SNR
22330EMKW33	150,000	320,000	108,000	45,90	33 SNR
22330EMW33	150,000	320,000	108,000	45,57	33 SNR
22330UAVS1	150,000	320,000	108,000	43,40	33 NTN
22330UAVS2	150,000	320,000	108,000	43,40	33 NTN
22332EF800	160,000	340,000	114,000	56,00	33 SNR
22332EF802	160,000	340,000	114,000	55,80	33 SNR
22332EKF800	160,000	340,000	114,000	54,50	33 SNR
22332EMKW33	160,000	340,000	114,000	55,70	33 SNR
22332EMW33	160,000	340,000	114,000	54,13	33 SNR
22332UAVS1	160,000	340,000	114,000	51,12	33 NTN
22332UAVS2	160,000	340,000	114,000	54,00	33 NTN
22334EF800	170,000	360,000	120,000	72,00	33 SNR
22334EF802	170,000	360,000	120,000	70,00	33 SNR
22334EKF800	170,000	360,000	120,000	59,55	33 SNR
22334EMKW33	170,000	360,000	120,000	66,00	33 SNR
22334EMW33	170,000	360,000	120,000	67,00	33 SNR
22334UAVS2	170,000	360,000	120,000	60,62	33 NTN
22336EMKW33	180,000	380,000	126,000	72,20	33 SNR
22336EMW33	180,000	380,000	126,000	72,84	33 SNR
22336UAVS1	180,000	380,000	126,000	67,60	33 NTN
22336UAVS2	180,000	380,000	126,000	71,40	33 NTN
22338B	190,000	400,000	132,000	81,00	33 NTN
22338BK	190,000	400,000	132,000	79,30	33 NTN
22338EMKW33	190,000	400,000	132,000	85,30	33 SNR
22338EMW33	190,000	400,000	132,000	81,60	33 SNR
22338UAVS1	190,000	400,000	132,000	82,60	33 NTN
22340B	200,000	420,000	138,000	93,20	33 NTN
22340BK	200,000	420,000	138,000	91,20	33 NTN
22340EMKW33	200,000	420,000	138,000	46,77	33 SNR
22340EMW33	200,000	420,000	138,000	47,50	33 SNR
22340UAVS2	200,000	420,000	138,000	95,20	33 NTN

Reference	d	D	B	Kg	Brands
22344B	220,000	460,000	145,000	115,26	33 NTN
22344BK	220,000	460,000	145,000	115,00	33 NTN
22344VMKW33	220,000	460,000	145,000	133,65	33 SNR
22344VMW33	220,000	460,000	145,000	140,25	33 SNR
22348B	240,000	500,000	155,000	148,00	33 NTN
22348BK	240,000	500,000	155,000	145,00	33 NTN
22348VMKW33	240,000	500,000	155,000	165,20	33 SNR
22348VMW33	240,000	500,000	155,000	172,62	33 SNR
22352B	260,000	540,000	165,000	197,00	33 NTN
22352BK	260,000	540,000	165,000	179,00	33 NTN
22352VMW33	260,000	540,000	164,000	192,00	33 SNR
22356B	280,000	580,000	175,000	243,00	33 NTN
22356BK	280,000	580,000	175,000	220,00	33 NTN
22356VMW33	280,000	580,000	175,000	241,36	33 SNR
22360B	300,000	620,000	185,000	270,00	33 NTN
22360BK	300,000	620,000	185,000	265,00	33 NTN
22380B	400,000	820,000	243,000	607,00	33 NTN
230/1000B	1 000,000	1 420,000	308,000	1 580,00	33 NTN
230/1000BK	1 000,000	1 420,000	308,000	1 520,00	33 NTN
230/1060B	1 060,000	1 500,000	325,000	1 850,00	33 NTN
230/1060BK	1 060,000	1 500,000	325,000	1 790,00	33 NTN
230/1120B	1 120,000	1 580,000	345,000	2 160,00	33 NTN
230/1120BK	1 120,000	1 580,000	345,000	2 090,00	33 NTN
230/500B	500,000	720,000	167,000	226,00	33 NTN
230/500BK	500,000	720,000	167,000	218,00	33 NTN
230/530B	530,000	780,000	185,000	306,00	33 NTN
230/530BK	530,000	780,000	185,000	295,00	33 NTN
230/560B	560,000	820,000	195,000	347,73	33 NTN
230/560BK	560,000	820,000	195,000	340,00	33 NTN
230/600B	600,000	870,000	200,000	400,00	33 NTN
230/600BK	600,000	870,000	200,000	386,00	33 NTN
230/630B	630,000	920,000	212,000	472,39	33 NTN
230/630BK	630,000	920,000	212,000	464,00	33 NTN
230/670B	670,000	980,000	230,000	578,39	33 NTN
230/670BK	900,000	980,000	230,000	573,00	33 NTN
230/710B	710,000	1 030,000	236,000	663,00	33 NTN
230/710BK	710,000	1 030,000	236,000	640,00	33 NTN
230/750B	750,000	1 090,000	250,000	790,00	33 NTN
230/750BK	750,000	1 090,000	250,000	763,00	33 NTN
230/800B	800,000	1 150,000	258,000	890,00	33 NTN
230/800BK	800,000	1 150,000	258,000	859,00	33 NTN
230/850B	850,000	1 220,000	272,000	1 050,00	33 NTN
230/850BK	850,000	1 220,000	272,000	1 010,00	33 NTN
230/900B	900,000	1 280,000	280,000	1 170,00	33 NTN

Reference	d	D	B	Kg	?	Brands
230/900BK	900,000	1 280,000	280,000	1 130,00	33	NTN
230/950B	950,000	1 360,000	300,000	1 430,00	33	NTN
230/950BK	950,000	1 360,000	300,000	1 380,00	33	NTN
23022EAKW33	110,000	170,000	45,000	3,59	33	SNR
23022EAW33	110,000	170,000	45,000	3,70	33	SNR
23022EMKW33	110,000	170,000	45,000	3,61	33	SNR
23022EMW33	110,000	170,000	45,000	3,73	33	SNR
23024EAKW33	120,000	180,000	46,000	3,95	33	SNR
23024EAW33	120,000	180,000	46,000	4,07	33	SNR
23024EMKW33	120,000	180,000	46,000	3,98	33	SNR
23024EMW33	120,000	180,000	46,000	505,59	33	SNR
23026EAKW33	130,000	200,000	52,000	5,76	33	SNR
23026EAW33	130,000	200,000	52,000	5,93	33	SNR
23026EMKW33	130,000	200,000	52,000	5,82	33	SNR
23026EMW33	130,000	200,000	52,000	6,00	33	SNR
23028EAKW33	140,000	210,000	53,000	6,20	33	SNR
23028EAW33	140,000	210,000	53,000	6,41	33	SNR
23028EMKW33	140,000	210,000	53,000	6,29	33	SNR
23028EMW33	140,000	210,000	53,000	6,48	33	SNR
23030EAKW33	150,000	225,000	56,000	7,53	33	SNR
23030EAW33	150,000	225,000	56,000	7,77	33	SNR
23030EM	150,000	225,000	56,000	7,91	33	SNR
23030EMKW33	150,000	225,000	56,000	7,64	33	SNR
23030EMW33	150,000	225,000	56,000	7,86	33	SNR
23032EAKW33	160,000	240,000	60,000	9,00	33	SNR
23032EAW33	160,000	240,000	60,000	9,40	33	SNR
23032EMKW33	160,000	240,000	60,000	9,25	33	SNR
23032EMW33	160,000	240,000	60,000	9,49	33	SNR
23034EAKW33	170,000	260,000	67,000	12,45	33	SNR
23034EAW33	170,000	260,000	67,000	12,85	33	SNR
23034EMKW33	170,000	260,000	67,000	12,63	33	SNR
23034EMW33	170,000	260,000	67,000	13,00	33	SNR
23036EAKW33	180,000	280,000	74,000	16,37	33	SNR
23036EAW33	180,000	280,000	74,000	16,79	33	SNR
23036EMKW33	180,000	280,000	74,000	16,55	33	SNR
23036EMW33	180,000	280,000	74,000	17,02	33	SNR
23038EAKW33	190,000	290,000	75,000	17,31	33	SNR
23038EAW33	190,000	290,000	75,000	17,93	33	SNR
23038EMKW33	190,000	290,000	75,000	17,60	33	SNR
23038EMW33	190,000	290,000	75,000	18,17	33	SNR
23040EMKW33	200,000	310,000	82,000	24,11	33	SNR
23040EMW33	200,000	310,000	82,000	26,81	33	SNR
23044EMKW33	220,000	340,000	90,000	33,13	33	SNR
23044EMW33	220,000	340,000	90,000	32,19	33	SNR
23048EMKW33	240,000	360,000	92,000	31,67	33	SNR
23048EMW33	240,000	360,000	92,000	34,91	33	SNR
23052B	260,000	400,000	104,000	48,50	33	NTN
23052BK	260,000	400,000	104,000	46,80	33	NTN

Reference	d	D	B	Kg	?	Brands
23052EMKW33	260,000	400,000	104,000	51,00	33	SNR
23052EMW33	260,000	400,000	104,000	52,20	33	SNR
23056B	280,000	420,000	106,000	52,40	33	NTN
23056BK	280,000	420,000	106,000	50,60	33	NTN
23056EMKW33	280,000	420,000	106,000	55,03	33	SNR
23056EMW33	280,000	420,000	106,000	54,08	33	SNR
23060B	300,000	460,000	118,000	71,90	33	NTN
23060BK	300,000	460,000	118,000	70,20	33	NTN
23060VMKW33	300,000	460,000	118,000	84,20	33	SNR
23060VMW33	300,000	460,000	118,000	80,59	33	SNR
23064B	320,000	480,000	121,000	77,40	33	NTN
23064BK	320,000	480,000	121,000	75,50	33	NTN
23064EMKW33	320,000	480,000	121,000	77,20	33	SNR
23064EMW33	320,000	480,000	121,000	79,60	33	SNR
23068B	340,000	520,000	133,000	104,00	33	NTN
23068BK	340,000	520,000	133,000	100,00	33	NTN
23068VMKW33	340,000	520,000	133,000	118,40	33	SNR
23068VMW33	340,000	520,000	133,000	118,75	33	SNR
23072B	360,000	540,000	134,000	110,00	33	NTN
23072BK	360,000	540,000	134,000	106,00	33	NTN
23072VMKW33	360,000	540,000	134,000	120,00	33	SNR
23072VMW33	360,000	540,000	134,000	124,65	33	SNR
23076B	380,000	560,000	135,000	115,00	33	NTN
23076BK	380,000	560,000	135,000	111,00	33	NTN
23076VMKW33	380,000	560,000	135,000	141,90	33	SNR
23076VMW33	380,000	560,000	135,000	136,65	33	SNR
23080B	400,000	600,000	148,000	149,00	33	NTN
23080BK	400,000	600,000	148,000	144,00	33	NTN
23080VMKW33	400,000	600,000	148,000	165,70	33	SNR
23080VMW33	400,000	600,000	148,000	172,73	33	SNR
23084B	420,000	620,000	150,000	157,00	33	NTN
23084BK	420,000	620,000	150,000	152,00	33	NTN
23088B	440,000	650,000	157,000	180,99	33	NTN
23088BK	440,000	650,000	157,000	175,00	33	NTN
23092B	460,000	680,000	163,000	206,00	33	NTN
23092BK	460,000	680,000	163,000	200,00	33	NTN
23096B	480,000	700,000	165,000	217,00	33	NTN
23096BK	480,000	700,000	165,000	209,00	33	NTN
231/500B	500,000	830,000	264,000	584,00	33	NTN
231/500BK	500,000	830,000	264,000	566,00	33	NTN
231/530B	530,000	870,000	272,000	631,08	33	NTN
231/530BK	530,000	870,000	272,000	633,00	33	NTN
231/560B	560,000	920,000	280,000	752,00	33	NTN
231/560BK	560,000	920,000	280,000	729,00	33	NTN
231/600B	600,000	980,000	300,000	908,00	33	NTN
231/600BK	600,000	980,000	300,000	880,00	33	NTN

Reference	d	D	B	Kg	Brands
231/630B	630,000	1 030,000	315,000	1 050,00	33 NTN
231/630BK	630,000	1 030,000	315,000	1 020,00	33 NTN
231/670B	670,000	1 090,000	336,000	1 250,00	33 NTN
231/670BK	900,000	1 090,000	336,000	1 210,00	33 NTN
231/710B	710,000	1 150,000	345,000	1 420,00	33 NTN
231/710BK	710,000	1 150,000	345,000	1 380,00	33 NTN
231/750B	750,000	1 220,000	365,000	1 700,00	33 NTN
231/750BK	750,000	1 220,000	365,000	1 650,00	33 NTN
231/800B	800,000	1 280,000	375,000	1 890,00	33 NTN
231/800BK	800,000	1 280,000	375,000	1 830,00	33 NTN
231/850B	850,000	1 360,000	400,000	2 270,00	33 NTN
231/850BK	850,000	1 360,000	400,000	2 200,00	33 NTN
231/900B	900,000	1 420,000	412,000	2 500,00	33 NTN
231/900BK	900,000	1 420,000	412,000	2 420,00	33 NTN
23120EAKW33	100,000	165,000	52,000	3,11	33 SNR
23120EAW33	100,000	165,000	52,000	4,43	33 SNR
23120EG15KW33	100,000	165,000	52,000	4,18	33 SNR
23120EG15W33	100,000	165,000	52,000	4,32	33 SNR
23120EMKW33	100,000	165,000	52,000	4,37	33 SNR
23120EMW33	100,000	165,000	52,000	4,67	33 SNR
23122EAKW33	110,000	180,000	56,000	5,41	33 SNR
23122EAW33	110,000	180,000	56,000	5,58	33 SNR
23122EMKW33	110,000	180,000	56,000	6,86	33 SNR
23122EMW33	110,000	180,000	56,000	5,61	33 SNR
23124EAKW33	120,000	200,000	62,000	7,55	33 SNR
23124EAW33	120,000	200,000	62,000	7,79	33 SNR
23124EMKW33	120,000	200,000	62,000	7,61	33 SNR
23124EMW33	120,000	200,000	62,000	7,88	33 SNR
23126EAKW33	130,000	210,000	64,000	8,26	33 SNR
23126EAW33	130,000	210,000	64,000	8,59	33 SNR
23126EMKW33	130,000	210,000	64,000	8,35	33 SNR
23126EMW33	130,000	210,000	64,000	8,63	33 SNR
23128EAKW33	140,000	225,000	68,000	10,00	33 SNR
23128EAW33	140,000	225,000	68,000	10,33	33 SNR
23128EMKW33	140,000	225,000	68,000	10,09	33 SNR
23128EMW33	140,000	225,000	68,000	10,41	33 SNR
23130EAKW33	150,000	250,000	80,000	15,30	33 SNR
23130EAW33	150,000	250,000	80,000	15,78	33 SNR
23130EMKW33	150,000	250,000	80,000	15,45	33 SNR
23130EMW33	150,000	250,000	80,000	15,97	33 SNR
23132EAKW33	160,000	270,000	86,000	19,44	33 SNR
23132EAW33	160,000	270,000	86,000	20,22	33 SNR
23132EMKW33	160,000	270,000	86,000	19,79	33 SNR
23132EMW33	160,000	270,000	86,000	20,36	33 SNR
23134EAKW33	170,000	280,000	88,000	20,97	33 SNR
23134EAW33	170,000	280,000	88,000	21,66	33 SNR
23134EMKW33	170,000	280,000	88,000	21,15	33 SNR
23134EMW33	170,000	280,000	88,000	21,84	33 SNR

Reference	d	D	B	Kg	Brands
23136EAKW33	180,000	300,000	96,000	29,81	33 SNR
23136EAW33	180,000	300,000	96,000	31,20	33 SNR
23136EMKW33	180,000	300,000	96,000	30,50	33 SNR
23136EMW33	180,000	300,000	96,000	31,50	33 SNR
23138EMKW33	190,000	320,000	104,000	37,30	33 SNR
23138EMW33	190,000	320,000	104,000	29,53	33 SNR
23140EMKW33	200,000	340,000	112,000	42,00	33 SNR
23140EMW33	200,000	340,000	112,000	41,70	33 SNR
23144EMKW33	220,000	370,000	120,000	57,17	33 SNR
23144EMW33	220,000	370,000	120,000	54,86	33 SNR
23148EMKW33	240,000	400,000	128,000	62,72	33 SNR
23148EMW33	240,000	400,000	128,000	64,72	33 SNR
23152B	260,000	440,000	144,000	91,10	33 NTN
23152BK	260,000	440,000	144,000	88,60	33 NTN
23152VMKW33	260,000	440,000	144,000	96,50	33 SNR
23152VMW33	260,000	440,000	144,000	100,80	33 SNR
23156B	280,000	460,000	146,000	96,80	33 NTN
23156BK	280,000	460,000	146,000	94,60	33 NTN
23156VMKW33	280,000	460,000	146,000	107,40	33 SNR
23156VMW33	280,000	460,000	146,000	112,05	33 SNR
23160B	300,000	500,000	160,000	125,86	33 NTN
23160BK	300,000	500,000	160,000	127,00	33 NTN
23160VMKW33	300,000	500,000	160,000	148,80	33 SNR
23160VMW33	300,000	500,000	160,000	146,20	33 SNR
23164B	320,000	540,000	176,000	164,45	33 NTN
23164BK	320,000	540,000	176,000	162,00	33 NTN
23164VMKW33	320,000	540,000	176,000	176,20	33 SNR
23164VMW33	320,000	540,000	176,000	187,50	33 SNR
23168B	340,000	580,000	190,000	205,86	33 NTN
23168BK	340,000	580,000	190,000	204,00	33 NTN
23168VMKW33	340,000	580,000	190,000	223,00	33 SNR
23168VMW33	340,000	580,000	190,000	228,40	33 SNR
23172B	360,000	600,000	192,000	222,00	33 NTN
23172BK	360,000	600,000	192,000	215,00	33 NTN
23172VMKW33	360,000	600,000	192,000	240,78	33 SNR
23172VMW33	360,000	600,000	192,000	239,50	33 SNR
23176B	380,000	620,000	194,000	235,00	33 NTN
23176BK	380,000	620,000	194,000	228,00	33 NTN
23180B	400,000	650,000	200,000	264,00	33 NTN
23180BK	400,000	650,000	200,000	256,00	33 NTN
23184B	420,000	700,000	224,000	354,00	33 NTN
23184BK	420,000	700,000	224,000	343,00	33 NTN
23188B	440,000	720,000	226,000	370,00	33 NTN
23188BK	440,000	720,000	226,000	358,00	33 NTN
23192B	460,000	760,000	240,000	443,00	33 NTN
23192BK	460,000	760,000	240,000	429,00	33 NTN

Reference	d	D	B	Kg		Brands
23196B	480,000	790,000	248,000	492,00	33	NTN
23196BK	480,000	790,000	248,000	477,00	33	NTN
232/500B	500,000	920,000	336,000	1 000,00	33	NTN
232/500BK	500,000	920,000	336,000	971,00	33	NTN
232/530B	530,000	980,000	355,000	1 200,00	33	NTN
232/530BK	530,000	980,000	355,000	1 170,00	33	NTN
232/560B	560,000	1 030,000	365,000	1 360,00	33	NTN
232/560BK	560,000	1 030,000	365,000	1 320,00	33	NTN
232/600B	600,000	1 090,000	388,000	1 540,00	33	NTN
232/600BK	600,000	1 090,000	388,000	1 490,00	33	NTN
232/630B	630,000	1 150,000	412,000	1 900,00	33	NTN
232/630BK	630,000	1 150,000	412,000	1 840,00	33	NTN
232/670B	670,000	1 220,000	438,000	2 270,00	33	NTN
232/670BK	900,000	1 220,000	438,000	2 200,00	33	NTN
232/710B	710,000	1 280,000	450,000	2 540,00	33	NTN
232/710BK	710,000	1 280,000	450,000	2 470,00	33	NTN
232/750B	750,000	1 360,000	475,000	3 050,00	33	NTN
232/750BK	750,000	1 360,000	475,000	2 960,00	33	NTN
232/850B	850,000	1 500,000	515,000	3 890,00	33	NTN
232/850BK	850,000	1 500,000	515,000	3 780,00	33	NTN
23218EAK	90,000	160,000	52,400	4,33	33	SNR
23218EAKW33	90,000	160,000	52,400	4,31	33	SNR
23218EAW33	90,000	160,000	52,400	4,43	33	SNR
23218EMKW33	90,000	160,000	52,400	4,38	33	SNR
23218EMW33	90,000	160,000	52,400	4,51	33	SNR
23220EAKW33	100,000	180,000	60,300	6,32	33	SNR
23220EAW33	100,000	180,000	60,300	6,50	33	SNR
23220EMKW33	100,000	180,000	60,300	6,42	33	SNR
23220EMW33	100,000	180,000	60,300	6,60	33	SNR
23222EAKW33	110,000	200,000	69,800	9,11	33	SNR
23222EAW33	110,000	200,000	69,800	9,39	33	SNR
23222EMKW33	110,000	200,000	69,800	9,26	33	SNR
23222EMW33	110,000	200,000	69,800	9,52	33	SNR
23224EAKW33	120,000	215,000	76,000	11,25	33	SNR
23224EAW33	120,000	215,000	76,000	11,64	33	SNR
23224EMKW33	120,000	215,000	76,000	11,45	33	SNR
23224EMW33	120,000	215,000	76,000	11,80	33	SNR
23226EAKW33	130,000	230,000	80,000	13,33	33	SNR
23226EAW33	130,000	230,000	80,000	13,76	33	SNR
23226EMKW33	130,000	230,000	80,000	13,56	33	SNR
23226EMW33	130,000	230,000	80,000	14,29	33	SNR
23228EAKW33	140,000	250,000	88,000	17,48	33	SNR
23228EAW33	140,000	250,000	88,000	18,04	33	SNR
23228EMKW33	140,000	250,000	88,000	17,89	33	SNR
23228EMW33	140,000	250,000	88,000	18,45	33	SNR
23230EAKW33	150,000	270,000	96,000	22,78	33	SNR

Reference	d	D	B	Kg		Brands
23230EAW33	150,000	270,000	96,000	23,51	33	SNR
23230EMKW33	150,000	270,000	96,000	23,12	33	SNR
23230EMW33	150,000	270,000	96,000	23,83	33	SNR
23232EAKW33	160,000	290,000	104,000	31,15	33	SNR
23232EAW33	160,000	290,000	104,000	33,90	33	SNR
23232EMKW33	160,000	290,000	104,000	32,45	33	SNR
23232EMW33	160,000	290,000	104,000	34,40	33	SNR
23234EMKW33	170,000	310,000	110,000	36,12	33	SNR
23234EMW33	170,000	310,000	110,000	26,78	33	SNR
23236EMKW33	180,000	320,000	112,000	30,00	33	SNR
23236EMW33	180,000	320,000	112,000	39,81	33	SNR
23238EMKW33	190,000	340,000	120,000	49,03	33	SNR
23238EMW33	190,000	340,000	120,000	36,25	33	SNR
23240EMKW33	200,000	360,000	128,000	62,30	33	SNR
23240EMW33	200,000	360,000	128,000	59,05	33	SNR
23244EMKW33	220,000	400,000	144,000	83,00	33	SNR
23244EMW33	220,000	400,000	144,000	82,77	33	SNR
23248B	240,000	440,000	160,000	108,00	33	NTN
23248BK	240,000	440,000	160,000	105,00	33	NTN
23248VMKW33	240,000	440,000	160,000	119,00	33	SNR
23248VMW33	240,000	440,000	160,000	112,40	33	SNR
23252B	260,000	480,000	174,000	141,00	33	NTN
23252BK	260,000	480,000	174,000	137,00	33	NTN
23252VMKW33	260,000	480,000	174,000	148,80	33	SNR
23252VMW33	260,000	480,000	174,000	152,45	33	SNR
23256B	260,000	500,000	176,000	160,00	33	NTN
23256BK	280,000	500,000	176,000	145,00	33	NTN
23256VMKW33	280,000	500,000	176,000	162,75	33	SNR
23256VMW33	280,000	500,000	176,000	171,25	33	SNR
23260B	300,000	540,000	192,000	188,47	33	NTN
23260BK	300,000	540,000	192,000	187,00	33	NTN
23260VMKW33	300,000	540,000	192,000	198,60	33	SNR
23260VMW33	300,000	540,000	192,000	205,90	33	SNR
23264B	320,000	580,000	208,000	236,90	33	NTN
23264BK	320,000	580,000	208,000	236,00	33	NTN
23268B	340,000	620,000	224,000	300,00	33	NTN
23268BK	340,000	620,000	224,000	291,00	33	NTN
23272B	360,000	650,000	232,000	339,00	33	NTN
23272BK	360,000	650,000	232,000	329,00	33	NTN
23276B	380,000	680,000	240,000	380,00	33	NTN
23276BK	380,000	680,000	240,000	369,00	33	NTN
23280B	400,000	720,000	256,000	457,00	33	NTN
23280BK	400,000	720,000	256,000	443,00	33	NTN
23284B	420,000	760,000	272,000	544,00	33	NTN
23284BK	420,000	760,000	272,000	528,00	33	NTN

Reference	d	D	B	Kg	Brands
23288B	440,000	790,000	280,000	586,46	33 NTN
23288BK	440,000	790,000	280,000	582,00	33 NTN
23292B	460,000	830,000	296,000	704,00	33 NTN
23292BK	460,000	830,000	296,000	683,00	33 NTN
23296B	480,000	870,000	310,000	814,00	33 NTN
23296BK	480,000	870,000	310,000	790,00	33 NTN
23318VS2	90,000	190,000	73,000	10,10	33 NTN
23324VS2	120,000	260,000	106,000	28,10	33 NTN
23328VS1	140,000	300,000	118,000	39,80	33 NTN
23328VS2	140,000	300,000	118,000	38,60	33 NTN
23332VS1	160,000	340,000	136,000	58,60	33 NTN
23332VS2	160,000	340,000	136,000	58,00	33 NTN
238/1120	1 120,000	1 360,000	180,000	536,00	33 NTN
238/1120K	1 120,000	1 360,000	180,000	517,00	33 NTN
238/1180	1 180,000	1 420,000	180,000	559,00	33 NTN
238/1180K	1 180,000	1 420,000	180,000	539,00	33 NTN
238/1250	1 250,000	1 500,000	185,000	630,00	33 NTN
238/500	500,000	620,000	90,000	59,60	33 NTN
238/500K	500,000	620,000	90,000	57,50	33 NTN
238/560	560,000	680,000	90,000	66,10	33 NTN
238/560K	560,000	680,000	90,000	63,70	33 NTN
238/750	750,000	920,000	128,000	184,58	33 NTN
238/750K	750,000	920,000	128,000	173,00	33 NTN
238/850	850,000	1 030,000	136,000	232,00	33 NTN
238/850K	850,000	1 030,000	136,000	223,00	33 NTN
23872	360,000	440,000	60,000	19,20	33 NTN
23872K	360,000	440,000	60,000	18,60	33 NTN
23884	420,000	520,000	75,000	34,80	33 NTN
23884K	420,000	520,000	75,000	33,60	33 NTN
23896	480,000	600,000	90,000	57,80	33 NTN
239/1000	1 000,000	1 320,000	236,000	916,00	33 NTN
239/1000K	1 000,000	1 320,000	236,000	887,00	33 NTN
239/1060	1 060,000	1 400,000	250,000	1 090,00	33 NTN
239/1060K	1 060,000	1 400,000	250,000	1 060,00	33 NTN
239/1120	1 120,000	1 460,000	250,000	1 140,00	33 NTN
239/1120K	1 120,000	1 460,000	250,000	1 100,00	33 NTN
239/1180	1 180,000	1 540,000	272,000	1 390,00	33 NTN
239/1180K	1 180,000	1 540,000	272,000	1 340,00	33 NTN
239/1250	1 250,000	1 630,000	280,000	1 600,00	33 NTN
239/1250K	1 250,000	1 630,000	280,000	1 550,00	33 NTN
239/1320	1 320,000	1 720,000	300,000	1 900,00	33 NTN
239/1320K	1 320,000	1 720,000	300,000	1 840,00	33 NTN
239/1400	1 400,000	1 820,000	315,000	2 230,00	33 NTN

Reference	d	D	B	Kg	Brands
239/1400K	1 400,000	1 820,000	315,000	2 160,00	33 NTN
239/500	500,000	670,000	128,000	131,00	33 NTN
239/500K	500,000	670,000	128,000	127,00	33 NTN
239/530	530,000	710,000	136,000	157,00	33 NTN
239/530K	530,000	710,000	136,000	152,00	33 NTN
239/560	560,000	750,000	140,000	182,00	33 NTN
239/560K	560,000	750,000	140,000	176,00	33 NTN
239/600	600,000	800,000	150,000	209,00	33 NTN
239/600K	600,000	800,000	150,000	211,00	33 NTN
239/630	630,000	850,000	165,000	277,00	33 NTN
239/630K	630,000	850,000	165,000	268,00	33 NTN
239/670	670,000	900,000	170,000	317,00	33 NTN
239/670K	900,000	900,000	170,000	307,00	33 NTN
239/710	710,000	950,000	180,000	375,00	33 NTN
239/710K	710,000	950,000	180,000	363,00	33 NTN
239/750	750,000	1 000,000	185,000	412,00	33 NTN
239/750K	750,000	1 000,000	185,000	399,00	33 NTN
239/800	800,000	1 060,000	195,000	467,12	33 NTN
239/800K	800,000	1 060,000	195,000	471,00	33 NTN
239/850	850,000	1 120,000	200,000	550,00	33 NTN
239/850K	850,000	1 120,000	200,000	532,00	33 NTN
239/900	900,000	1 180,000	206,000	623,00	33 NTN
239/900K	900,000	1 180,000	206,000	603,00	33 NTN
239/950	950,000	1 250,000	224,000	774,00	33 NTN
239/950K	950,000	1 250,000	224,000	749,00	33 NTN
23932	160,000	220,000	45,000	5,50	33 NTN
23934	170,000	230,000	45,000	5,34	33 NTN
23936	180,000	250,000	52,000	7,80	33 NTN
23938	190,000	260,000	52,000	8,60	33 NTN
23938K	190,000	260,000	52,000	8,34	33 NTN
23940	200,000	280,000	60,000	11,48	33 NTN
23940K	200,000	280,000	60,000	11,70	33 NTN
23944	220,000	300,000	60,000	12,80	33 NTN
23944EMW33	220,000	300,000	60,000	12,56	33 SNR
23944K	220,000	300,000	60,000	12,70	33 NTN
23948	240,000	320,000	60,000	13,20	33 NTN
23948K	240,000	320,000	60,000	13,60	33 NTN
23952	260,000	360,000	75,000	23,50	33 NTN
23956	280,000	380,000	75,000	24,00	33 NTN
23956K	280,000	380,000	75,000	25,60	33 NTN
23960	300,000	420,000	90,000	38,81	33 NTN
23960/302	302,000	420,000	90,000	40,00	33 NTN
23960K	300,000	420,000	90,000	38,70	33 NTN

Reference	d	D	B	Kg	?	Brands
23964	320,000	440,000	90,000	41,32	33	NTN
23964K	320,000	440,000	90,000	41,70	33	NTN
23968	340,000	460,000	90,000	42,90	33	NTN
23968K	330,000	460,000	90,000	43,30	33	NTN
23972	360,000	480,000	90,000	44,96	33	NTN
23972K	360,000	480,000	90,000	45,70	33	NTN
23976	380,000	520,000	106,000	69,90	33	NTN
23976K	380,000	520,000	106,000	67,70	33	NTN
23980	400,000	540,000	106,000	73,00	33	NTN
23980K	400,000	540,000	106,000	70,70	33	NTN
23984	420,000	560,000	106,000	76,20	33	NTN
23984K	420,000	560,000	106,000	73,80	33	NTN
23988	440,000	600,000	118,000	101,00	33	NTN-SNR
23988K	440,000	600,000	118,000	98,00	33	NTN
23992	460,000	620,000	118,000	107,00	33	NTN
23992K	460,000	620,000	118,000	104,00	33	NTN
23996	480,000	650,000	128,000	123,00	33	NTN
23996K	480,000	650,000	128,000	119,00	33	NTN
240/1000B	1 000,000	1 420,000	412,000	2 110,00	33	NTN
240/1000BK30	1 000,000	1 420,000	412,000	2 080,00	33	NTN
240/1060B	1 060,000	1 500,000	438,000	2 450,00	33	NTN
240/1060BK30	1 060,000	1 500,000	438,000	2 140,00	33	NTN
240/1120B	1 120,000	1 580,000	462,000	2 890,00	33	NTN
240/1120BK30	1 120,000	1 580,000	462,000	2 840,00	33	NTN
240/1180B	1 180,000	1 660,000	475,000	3 220,00	33	NTN
240/1180BK30	1 180,000	1 660,000	475,000	3 170,00	33	NTN
240/1320B	1 320,000	1 850,000	530,000	4 320,00	33	NTN
240/1320BK30	1 320,000	1 850,000	530,000	4 240,00	33	NTN
240/500B	500,000	720,000	218,000	295,00	33	NTN
240/500BK30	500,000	720,000	218,000	290,00	33	NTN
240/530B	530,000	780,000	250,000	413,00	33	NTN
240/530BK30	530,000	780,000	250,000	406,00	33	NTN
240/560B	560,000	820,000	258,000	467,00	33	NTN
240/560BK30	560,000	820,000	258,000	459,00	33	NTN
240/600B	600,000	870,000	272,000	544,00	33	NTN
240/600BK30	600,000	870,000	272,000	535,00	33	NTN
240/630B	630,000	920,000	290,000	657,00	33	NTN
240/630BK30	630,000	920,000	290,000	646,00	33	NTN
240/670B	670,000	980,000	308,000	794,00	33	NTN
240/670BK30	900,000	980,000	308,000	781,00	33	NTN
240/710B	710,000	1 030,000	315,000	884,00	33	NTN
240/710BK30	710,000	1 030,000	315,000	870,00	33	NTN

Reference	d	D	B	Kg	?	Brands
240/750B	750,000	1 090,000	335,000	1 060,00	33	NTN
240/750BK30	750,000	1 090,000	335,000	1 040,00	33	NTN
240/800B	800,000	1 150,000	345,000	1 190,00	33	NTN
240/800BK30	800,000	1 150,000	345,000	1 170,00	33	NTN
240/850B	850,000	1 220,000	365,000	1 410,00	33	NTN
240/850BK30	850,000	1 220,000	365,000	1 390,00	33	NTN
240/900B	900,000	1 280,000	375,000	1 570,00	33	NTN
240/900BK30	900,000	1 280,000	375,000	1 540,00	33	NTN
240/950B	950,000	1 360,000	412,000	1 970,00	33	NTN
240/950BK30	950,000	1 360,000	412,000	1 940,00	33	NTN
24020EAW33	100,000	150,000	50,000	2,98	33	SNR
24022EAW33	110,000	170,000	60,000	4,81	33	SNR
24024EAK30W33	120,000	180,000	60,000	5,07	33	SNR
24024EAW33	120,000	180,000	60,000	5,16	33	SNR
24026EAK30W33	130,000	200,000	69,000	7,41	33	SNR
24026EAW33	130,000	200,000	69,000	7,52	33	SNR
24028EAK30W33	140,000	210,000	69,000	8,03	33	SNR
24028EAW33	140,000	210,000	69,000	8,15	33	SNR
24030EAK30W33	150,000	225,000	75,000	9,90	33	SNR
24030EAW33	150,000	225,000	75,000	10,14	33	SNR
24032EAK30W33	160,000	240,000	80,000	11,77	33	SNR
24032EAW33	160,000	240,000	80,000	11,96	33	SNR
24034EAK30W33	170,000	260,000	90,000	16,20	33	SNR
24034EAW33	170,000	260,000	90,000	17,00	33	SNR
24036EAK30W33	180,000	280,000	100,000	25,33	33	SNR
24036EAW33	180,000	280,000	100,000	23,74	33	SNR
24036EAW34	180,000	280,000	100,000	24,00	33	SNR
24038EMK30W33	190,000	290,000	100,000	25,90	33	SNR
24038EMW33	190,000	290,000	100,000	26,35	33	SNR
24040EMK30W33	200,000	310,000	109,000	30,45	33	SNR
24040EMW33	200,000	310,000	109,000	33,70	33	SNR
24044EMK30W33	220,000	340,000	118,000	38,00	33	SNR
24044EMW33	220,000	340,000	118,000	41,17	33	SNR
24048EMK30W33	240,000	360,000	118,000	41,00	33	SNR
24048EMW33	240,000	360,000	118,000	48,20	33	SNR
24052B	260,000	400,000	140,000	65,20	33	NTN
24052BK30	260,000	400,000	140,000	64,10	33	NTN
24052VMK30W33	260,000	400,000	140,000	63,90	33	SNR
24052VMW33	260,000	400,000	140,000	65,75	33	SNR
24056B	280,000	420,000	140,000	69,00	33	NTN
24056BK30	280,000	420,000	140,000	67,90	33	NTN
24056EMK30W33	280,000	420,000	140,000	64,90	33	SNR
24056EMW33	280,000	420,000	140,000	72,30	33	SNR

Reference	d	D	B	Kg	Brands
24060B	300,000	460,000	160,000	106,00	33 NTN
24060BK30	300,000	460,000	160,000	96,40	33 NTN
24060VMK30W33	300,000	460,000	160,000	103,40	33 SNR
24060VMW33	300,000	460,000	160,000	164,10	33 SNR
24064B	320,000	480,000	160,000	101,91	33 NTN
24064BK30	320,000	480,000	160,000	101,00	33 NTN
24068B	340,000	520,000	180,000	140,00	33 NTN
24068BK30	340,000	520,000	180,000	138,00	33 NTN
24072B	360,000	540,000	180,000	147,00	33 NTN
24072BK30	360,000	540,000	180,000	145,00	33 NTN
24076B	380,000	560,000	180,000	153,00	33 NTN
24076BK30	380,000	560,000	180,000	150,00	33 NTN
24080B	400,000	600,000	200,000	202,00	33 NTN
24080BK30	400,000	600,000	200,000	200,00	33 NTN
24084B	420,000	620,000	200,000	221,00	33 NTN
24084BK30	420,000	620,000	200,000	207,00	33 NTN
24088B	440,000	650,000	212,000	245,00	33 NTN
24088BK30	440,000	650,000	212,000	241,00	33 NTN
24092B	460,000	680,000	218,000	308,00	33 NTN
24092BK30	460,000	680,000	218,000	272,00	33 NTN
24096B	480,000	700,000	218,000	282,00	33 NTN
24096BK30	480,000	700,000	218,000	280,00	33 NTN
241/1000BK30	1 000,000	1 580,000	580,000	4 220,00	33 NTN
241/500B	500,000	830,000	325,000	716,00	33 NTN
241/500BK30	500,000	830,000	325,000	705,00	33 NTN
241/530B	530,000	870,000	335,000	800,00	33 NTN
241/530BK30	530,000	870,000	335,000	788,00	33 NTN
241/560B	560,000	920,000	355,000	948,00	33 NTN
241/560BK30	560,000	920,000	355,000	934,00	33 NTN
241/600B	600,000	980,000	375,000	1 130,00	33 NTN
241/600BK30	600,000	980,000	375,000	1 110,00	33 NTN
241/630B	630,000	1 030,000	400,000	1 330,00	33 NTN
241/630BK30	630,000	1 030,000	400,000	1 310,00	33 NTN
241/670B	670,000	1 090,000	412,000	1 530,00	33 NTN
241/670BK30	900,000	1 090,000	412,000	1 510,00	33 NTN
241/710B	710,000	1 150,000	438,000	1 800,00	33 NTN
241/710BK30	710,000	1 150,000	438,000	1 770,00	33 NTN
24122EAW33	110,000	180,000	69,000	6,65	33 SNR
24124EAK30W33	120,000	200,000	80,000	9,73	33 SNR
24124EAW33	120,000	200,000	80,000	9,93	33 SNR
24126EAK30W33	130,000	210,000	80,000	10,21	33 SNR
24126EAW33	130,000	210,000	80,000	10,34	33 SNR

Reference	d	D	B	Kg	Brands
24128EAK30W33	140,000	225,000	85,000	12,37	33 SNR
24128EAW33	140,000	225,000	85,000	12,56	33 SNR
24130EAK30W33	150,000	250,000	100,000	18,60	33 SNR
24130EAW33	150,000	250,000	100,000	19,21	33 SNR
24132EAK30W33	160,000	270,000	109,000	24,36	33 SNR
24132EAW33	160,000	270,000	109,000	24,80	33 SNR
24134EAK30W33	170,000	280,000	109,000	29,10	33 SNR
24134EAW33	170,000	280,000	109,000	32,80	33 SNR
24136EAK30W33	180,000	300,000	118,000	33,40	33 SNR
24136EAW33	180,000	300,000	118,000	36,95	33 SNR
24138EAK30W33	190,000	320,000	128,000	43,90	33 SNR
24138EAW33	190,000	320,000	128,000	44,50	33 SNR
24140EMK30W33	200,000	340,000	140,000	55,05	33 SNR
24140EMW33	200,000	340,000	140,000	55,47	33 SNR
24144EMK30W33	220,000	370,000	150,000	68,00	33 SNR
24144EMW33	220,000	370,000	150,000	68,00	33 SNR
24148B	240,000	400,000	160,000	79,18	33 NTN
24148BK30	240,000	400,000	160,000	82,00	33 NTN
24148VMK30W33	240,000	400,000	160,000	86,90	33 SNR
24148VMW33	240,000	400,000	160,000	93,80	33 SNR
24148VW33	240,000	400,000	160,000	83,50	33 SNR
24152B	260,000	440,000	180,000	118,00	33 NTN
24152BK30	260,000	440,000	180,000	112,00	33 NTN
24152VMK30W33	260,000	440,000	180,000	180,00	33 SNR
24152VMW33	260,000	440,000	180,000	120,65	33 SNR
24156B	280,000	460,000	180,000	117,00	33 NTN
24156BK30	280,000	460,000	180,000	118,00	33 NTN
24156VMK30W33	280,000	460,000	180,000	119,00	33 SNR
24156VMW33	280,000	460,000	180,000	127,50	33 SNR
24160B	300,000	500,000	200,000	155,45	33 NTN
24160BK30	300,000	500,000	200,000	159,00	33 NTN
24160VMK30W33	300,000	500,000	200,000	128,20	33 SNR
24160VMW33	300,000	500,000	200,000	175,00	33 SNR
24164B	320,000	540,000	218,000	207,00	33 NTN
24164BK30	320,000	540,000	218,000	204,00	33 NTN
24168B	340,000	580,000	243,000	269,00	33 NTN
24168BK30	340,000	580,000	243,000	265,00	33 NTN
24168VW33	340,000	580,000	243,000	266,00	33 SNR
24172B	360,000	600,000	243,000	281,00	33 NTN
24172BK30	360,000	600,000	243,000	277,00	33 NTN
24176B	380,000	620,000	243,000	292,00	33 NTN
24176BK30	380,000	620,000	243,000	287,00	33 NTN
24180B	400,000	650,000	250,000	329,00	33 NTN
24180BK30	400,000	650,000	250,000	324,00	33 NTN
24184B	420,000	700,000	280,000	440,00	33 NTN

Reference	d	D	B	Kg	?	Brands
24184BK30	420,000	700,000	280,000	433,00	33	NTN
24188B	440,000	720,000	280,000	456,00	33	NTN
24188BK30	440,000	720,000	280,000	449,00	33	NTN
24192B	460,000	760,000	300,000	550,00	33	NTN
24192BK30	460,000	760,000	300,000	541,00	33	NTN
24196B	480,000	790,000	308,000	608,00	33	NTN
24196BK30	480,000	790,000	308,000	600,00	33	NTN
248/1500	1 500,000	1 820,000	315,000	1 660,00	33	NTN
248/1500K30	1 500,000	1 820,000	315,000	1 580,00	33	NTN
248/1800	1 800,000	2 180,000	375,000	2 830,00	33	NTN
248/1800K30	1 800,000	2 180,000	375,000	2 770,00	33	NTN
248/630	630,000	780,000	150,000	158,00	33	NTN
248/630K30	630,000	780,000	150,000	155,00	33	NTN
24864	320,000	400,000	80,000	22,80	33	NTN
24864K30	320,000	400,000	80,000	22,40	33	NTN
24880	400,000	500,000	100,000	45,30	33	NTN
24880K30	400,000	500,000	100,000	44,50	33	NTN
24892	460,000	580,000	118,000	73,60	33	NTN
24892K30	460,000	580,000	118,000	72,30	33	NTN
249/1180	1 180,000	1 540,000	355,000	1 740,00	33	NTN
249/1180K30	1 180,000	1 540,000	355,000	1 660,00	33	NTN
292/1060	1 060,000	1 400,000	206,000	874,00	39	NTN
292/710	710,000	950,000	145,000	292,00	39	NTN
29230	150,000	215,000	39,000	4,44	39	NTN
29232	160,000	225,000	39,000	4,81	39	NTN
29234	170,000	240,000	42,000	5,94	39	NTN
29236	180,000	250,000	42,000	6,24	39	NTN
29238	190,000	270,000	48,000	8,67	39	NTN
29240	200,000	280,000	48,000	9,00	39	NTN
29244	220,000	300,000	48,000	9,79	39	NTN
29248	240,000	340,000	60,000	17,20	39	NTN
29252	260,000	360,000	60,000	19,00	39	NTN
29256	280,000	380,000	60,000	19,60	39	NTN
29260	300,000	420,000	73,000	30,60	39	NTN
29264	320,000	440,000	73,000	33,50	39	NTN
29268	340,000	460,000	73,000	34,40	39	NTN
29272	360,000	500,000	85,000	50,00	39	NTN
29276	380,000	520,000	85,000	52,60	39	NTN
29280	400,000	540,000	85,000	55,20	39	NTN
29284	420,000	580,000	95,000	76,60	39	NTN
29288	440,000	600,000	95,000	79,60	39	NTN
29292	460,000	620,000	95,000	82,80	39	NTN
29296	480,000	650,000	103,000	98,60	39	NTN
293/500	500,000	750,000	150,000	235,00	39	NTN
29317	85,000	150,000	39,000	2,88	39	NTN
29318	90,000	155,000	39,000	3,02	39	NTN

Reference	d	D	B	Kg	?	Brands
29320	100,000	170,000	42,000	3,87	39	NTN
29320E	100,000	170,000	42,000	3,65	39	SNR
29322	110,000	190,000	48,000	5,70	39	NTN
29322E	110,000	190,000	48,000	5,40	39	SNR
29324	120,000	210,000	54,000	7,80	39	NTN
29324E	120,000	210,000	54,000	7,24	39	SNR
29326	130,000	225,000	58,000	9,65	39	NTN
29326E	130,000	225,000	58,000	8,98	39	SNR
29328	140,000	240,000	60,000	11,22	39	NTN
29328E	140,000	240,000	60,000	10,40	39	SNR
29330	150,000	250,000	60,000	11,70	39	NTN
29330E	150,000	250,000	60,000	16,10	39	SNR
29332	160,000	270,000	67,000	15,70	39	NTN
29332E	160,000	270,000	67,000	14,40	39	SNR
29334	170,000	280,000	67,000	16,50	39	NTN
29334E	170,000	280,000	67,000	15,10	39	SNR
29336	180,000	300,000	73,000	21,00	39	NTN
29336E	180,000	300,000	73,000	26,10	39	SNR
29338	190,000	320,000	78,000	25,80	39	NTN
29338E	190,000	320,000	78,000	33,50	39	SNR
29340	200,000	340,000	85,000	31,90	39	NTN
29340E	200,000	340,000	85,000	37,40	39	SNR
29344	220,000	360,000	85,000	34,20	39	NTN
29344E	220,000	360,000	85,000	49,00	39	SNR
29348	240,000	380,000	85,000	36,20	39	NTN
29348E	240,000	380,000	85,000	48,80	39	SNR
29352	260,000	420,000	95,000	51,34	39	NTN
29352E	260,000	420,000	95,000	55,80	39	SNR
29356	280,000	440,000	95,000	54,60	39	NTN
29356E	280,000	440,000	95,000	59,00	39	SNR
29360	300,000	480,000	109,000	74,90	39	NTN
29360E	300,000	480,000	109,000	85,50	39	SNR
29364	320,000	500,000	109,000	79,10	39	NTN
29364E	320,000	500,000	109,000	90,20	39	SNR
29368	340,000	540,000	122,000	107,00	39	NTN
29372	360,000	560,000	122,000	122,00	39	NTN
29376	380,000	600,000	132,000	143,00	39	NTN
29380	400,000	620,000	132,000	148,00	39	NTN
29384	420,000	650,000	140,000	172,00	39	NTN
29388	440,000	680,000	145,000	195,00	39	NTN
29392	460,000	710,000	150,000	221,00	39	NTN
29396	480,000	730,000	150,000	228,00	39	NTN
294/560	560,000	980,000	250,000	815,00	39	NTN

Reference	d	D	B	Kg	?	Brands
294/560/540	540,000	980,000	250,000	825,00	39	NTN
294/600	600,000	1 030,000	258,000	898,00	39	NTN
294/750	750,000	1 280,000	315,000	1 700,00	39	NTN
294/800	800,000	1 360,000	335,000	2 040,00	39	NTN
29412	60,000	130,000	42,000	2,74	39	NTN
29412E	60,000	130,000	42,000	2,47	39	SNR
29413	65,000	140,000	45,000	3,40	39	NTN
29413E	65,000	140,000	45,000	3,26	39	SNR
29414	70,000	150,000	48,000	4,14	39	NTN
29414E	70,000	150,000	48,000	3,89	39	SNR
29415	75,000	160,000	51,000	5,01	39	NTN
29415E	75,000	160,000	51,000	4,77	39	SNR
29416	80,000	170,000	54,000	6,04	39	NTN
29416E	80,000	170,000	54,000	5,68	39	SNR
29417	85,000	180,000	58,000	7,10	39	NTN
29417E	85,000	180,000	58,000	6,67	39	SNR
29418	90,000	190,000	60,000	8,30	39	NTN
29418E	90,000	190,000	60,000	7,77	39	SNR
29420	100,000	210,000	67,000	11,40	39	NTN
29420E	100,000	210,000	67,000	10,80	39	SNR
29422	110,000	230,000	73,000	14,90	39	NTN
29422E	110,000	230,000	73,000	17,50	39	SNR
29424	120,000	250,000	78,000	18,40	39	NTN
29424E	120,000	250,000	78,000	17,50	39	SNR
29426	130,000	270,000	85,000	23,50	39	NTN
29426E	130,000	270,000	85,000	27,00	39	SNR
29428	140,000	280,000	85,000	22,90	39	NTN
29428E	140,000	280,000	85,000	28,39	39	SNR
29430	150,000	300,000	90,000	30,30	39	NTN
29430E	150,000	300,000	90,000	40,00	39	SNR
29432	160,000	320,000	95,000	36,60	39	NTN-SNR
29434	170,000	340,000	103,000	44,70	39	NTN-SNR
29436	180,000	360,000	109,000	52,80	39	NTN-SNR
29438	190,000	380,000	115,000	62,00	39	NTN-SNR
29440	200,000	400,000	122,000	72,82	39	NTN-SNR
29444	220,000	420,000	122,000	77,30	39	NTN-SNR
29448	240,000	440,000	122,000	89,00	39	NTN-SNR
29452	260,000	480,000	132,000	108,00	39	NTN-SNR
29456	280,000	520,000	145,000	139,51	39	NTN
29456E	280,000	520,000	145,000	146,30	39	SNR
29460	300,000	540,000	145,000	146,54	39	NTN
29460E	300,000	540,000	145,000	148,00	39	SNR
29464	320,000	580,000	155,000	181,49	39	NTN
29464E	320,000	580,000	155,000	181,00	39	SNR

Reference	d	D	B	Kg	?	Brands
29468	340,000	620,000	170,000	252,00	39	NTN
29472	360,000	640,000	170,000	240,00	39	NTN
29476	380,000	670,000	175,000	266,61	39	NTN
29480	400,000	710,000	185,000	320,95	39	NTN
29484	420,000	730,000	185,000	428,37	39	NTN
29488	440,000	780,000	206,000	428,00	39	NTN
29492	460,000	800,000	206,000	443,00	39	NTN
29496	480,000	850,000	224,000	552,00	39	NTN
2P0603	530,000	750,000	248,000	329,20	33	NTN
2P10901	545,000	755,000	230,000	322,00	33	NTN
2P10901K	545,000	755,000	230,000	286,00	33	NTN
2P1109LL	55,000	120,000	43,000	2,14	33	NTN
2P1111	55,000	95,000	37,000	1,13	33	NTN
2P1201	560,000	750,000	248,000	297,80	33	NTN
2P13601	680,000	980,000	220,000	550,00	33	NTN
2P13601K	680,000	980,000	220,000	533,00	33	NTN
2P1403	70,000	155,000	58,000	5,44	33	NTN
2P1410LL	70,000	150,000	51,000	4,11	33	NTN
2P15203	760,000	1 140,000	325,000	1 150,00	33	NTN
2P15203K	760,000	1 140,000	325,000	1 060,00	33	NTN
2P15605	780,000	1 220,000	375,000	1 610,00	33	NTN
2P15605K	780,000	1 220,000	375,000	1 560,00	33	NTN
2P15802	790,000	1 100,000	310,000	953,00	33	NTN
2P15802K	790,000	1 100,000	310,000	817,00	33	NTN
2P1608LL	80,000	170,000	58,000	6,46	33	NTN
2P17001	850,000	1 220,000	290,000	1 100,00	33	NTN
2P17001K	850,000	1 220,000	290,000	1 070,00	33	NTN
2P17011	850,000	1 220,000	290,000	1 060,00	33	NTN
2P17011K	850,000	1 220,000	290,000	1 020,00	33	NTN
2P17012	850,000	1 220,000	330,000	1 240,00	33	NTN
2P17012K	850,000	1 220,000	330,000	1 160,00	33	NTN
2P18003K30	900,000	1 280,000	375,000	1 550,00	33	NTN
2P1818	90,000	160,000	69,000	5,20	33	NTN
2P19013	950,000	1 330,000	300,000	1 210,00	33	NTN
2P19013K	950,000	1 330,000	300,000	1 170,00	33	NTN
2P19014	950,000	1 280,000	260,000	921,00	33	NTN
2P19014K	950,000	1 280,000	260,000	888,00	33	NTN
2P19019	950,000	1 400,000	380,000	1 940,00	33	NTN
2P19019K	950,000	1 400,000	380,000	1 870,00	33	NTN
2P19022	950,000	1 360,000	320,000	1 450,00	33	NTN
2P19022K	950,000	1 360,000	320,000	1 400,00	33	NTN
2P20002	1 000,000	1 320,000	258,000	911,00	33	NTN
2P20002K	1 000,000	1 320,000	258,000	877,00	33	NTN
2P2014	100,000	170,000	65,000	6,11	33	NTN
2P21001	1 050,000	1 500,000	412,000	2 290,00	33	NTN
2P21001K	1 050,000	1 500,000	412,000	2 200,00	33	NTN

Reference	d	D	B	Kg	?	Brands
2P21202	1 060,000	1 500,000	340,000	1 870,00	33	NTN
2P21202K	1 060,000	1 500,000	340,000	1 810,00	33	NTN
2P2206	110,000	180,000	82,000	7,97	33	NTN
2P2212L	110,000	180,000	69,000	6,68	33	NTN
2P24005	1 200,000	1 700,000	410,000	2 860,00	33	NTN
2P24005K	1 200,000	1 700,000	410,000	2 750,00	33	NTN
2P24007	1 200,000	1 700,000	410,000	2 830,00	33	NTN
2P24007K	1 200,000	1 700,000	410,000	2 730,00	33	NTN
2P25002	1 250,000	1 750,000	390,000	2 880,00	33	NTN
2P25002K	1 250,000	1 750,000	390,000	2 780,00	33	NTN
2P2635LLS	130,000	230,000	89,000	15,50	33	NTN
2P26402	1 320,000	1 850,000	480,000	3 830,00	33	NTN
2P26402K	1 320,000	1 850,000	480,000	3 670,00	33	NTN
2P3016	150,000	225,000	56,000	7,00	33	NTN
2P3019	150,000	250,000	100,000	18,30	33	NTN
2P3032L	150,000	250,000	100,000	18,30	33	NTN
2P3411LLK	170,000	280,000	88,000	19,40	33	NTN
2P4602	228,600	400,050	139,700	77,70	33	NTN
2P5217L	260,000	480,000	174,000	138,00	33	NTN
2P6404	320,000	580,000	213,000	241,00	33	NTN
2P6404K	320,000	580,000	213,000	233,00	33	NTN
2P6601	320,000	540,000	186,000	166,00	33	NTN
2P6601K	320,000	540,000	186,000	160,00	33	NTN
2P6802	340,000	620,000	229,000	298,00	33	NTN
2P6802K	340,000	620,000	229,000	288,00	33	NTN
2P7010	842,000	1 220,000	502,000	1 560,00	33	NTN
2P7012	850,000	1 280,000	375,000	1 580,00	33	NTN
2P7201	360,000	520,000	133,000	92,80	33	NTN
2P7201K	360,000	520,000	133,000	89,50	33	NTN
2P7202	360,000	480,000	75,000	37,10	33	NTN
2P7202K	360,000	480,000	75,000	36,10	33	NTN
2P7205	360,000	530,000	127,000	95,30	33	NTN
2P7205K	360,000	530,000	127,000	92,30	33	NTN
2P7206	360,000	610,000	255,000	290,00	33	NTN

Reference	d	D	B	Kg	?	Brands
2P7206K	360,000	610,000	255,000	277,00	33	NTN
2P7603	380,000	680,000	245,000	382,00	33	NTN
2P7603K	380,000	680,000	245,000	370,00	33	NTN
2P7801	390,000	510,000	90,000	47,30	33	NTN
2P7801K	390,000	510,000	90,000	45,70	33	NTN
2P8002	400,000	720,000	260,000	457,00	33	NTN
2P8002K	400,000	720,000	260,000	443,00	33	NTN
2P8802	440,000	790,000	285,000	588,00	33	NTN
2P8802K	440,000	790,000	285,000	576,00	33	NTN
2P9002	450,000	620,000	190,000	171,00	33	NTN
2P9002K	450,000	620,000	190,000	157,00	33	NTN
2P9203	460,000	620,000	140,000	122,00	33	NTN
2P9203K	460,000	620,000	140,000	118,00	33	NTN
2P9602	480,000	660,000	200,000	195,00	33	NTN
2P9602K	480,000	660,000	200,000	185,00	33	NTN
2P9801	490,000	650,000	130,000	114,00	33	NTN
2P9801K	490,000	650,000	130,000	109,00	33	NTN
2PE24006	1 200,000	1 700,000	730,000	4 220,00	33	NTN
2PE2606	130,000	215,000	172,000	21,00	33	NTN
2PE3303	165,000	275,000	194,000	45,00	33	NTN
2PE3801	190,000	290,000	150,000	35,00	33	NTN
2PE6303	315,910	520,000	210,000	161,00	33	NTN
2PE7204	360,000	540,000	212,000	156,48	33	NTN
2PE7206	360,000	540,000	212,000	156,48	33	NTN
MX-22318UAVS2	90,000	190,000	64,000	8,66	33	NTN
MX-22320UAVS2	100,000	215,000	73,000	12,70	33	NTN
MX-22324UAVS2	120,000	260,000	86,000	21,90	33	NTN
MX-22328UAVS2	140,000	300,000	102,000	34,40	33	NTN
MX-22330UAVS2	150,000	320,000	108,000	41,30	33	NTN
MX-22332UAVS2	160,000	340,000	114,000	49,20	33	NTN
MX-22338UAVS2	190,000	400,000	132,000	78,40	33	NTN
MX-RE2224V	110,000	186,000	154,000	17,25	33	NTN
MX-RE2906V	145,000	202,000	196,000	19,30	33	NTN
MX-RE3621V	180,000	290,000	169,000	43,50	33	NTN





 Needle roller bearing

 Nadellager

 Rodamientos de agujas

 Игольчатые подшипники

 Roulements à aiguilles

 Cuscinetti a rullini

 Rolamentos de agulhas

 Łożyska igielkowe



Classification by references – Classification par références

Klassifizierung nach Referenzen – Classificazione per codice

Clasificación por referencias – Classificação por referências

Классификация по кодам – Klasyfikacja wg numerów katalogowych

Reference	d	D	B	Kg	?	Brands
1R100X110X30	100,000	110,000	30,000	1,11	55	NTN
1R100X110X40	100,000	110,000	40,000	2,31	55	NTN
1R100X110X63	100,000	110,000	63,000	0,81	55	NTN
1R100X115X32	100,000	115,000	32,000	1,86	55	NTN
1R100X115X40	100,000	115,000	40,000	2,31	55	NTN
1R100X115X54	100,000	115,000	54,000	3,14	55	NTN
1R104X110X30	104,000	110,000	30,000	0,23	55	NTN
1R10X13X12.5	10,000	13,000	12,500	0,01	55	NTN
1R10X14X12	10,000	14,000	12,000	0,01	55	NTN
1R10X14X13	10,000	14,000	13,000	0,02	55	NTN
1R10X14X16	10,000	14,000	16,000	0,03	55	NTN
1R10X14X20	10,000	14,000	20,000	0,04	55	NTN
1R10X15X15.5	10,000	15,000	15,500	0,01	55	NTN
1R10X15X20.5	10,000	15,000	20,500	0,02	55	NTN
1R10X16X16	10,000	16,000	16,000	0,03	55	NTN
1R110X120X30	110,000	120,000	30,000	1,23	55	NTN
1R110X120X40	110,000	120,000	40,000	1,10	55	NTN
1R110X125X120	110,000	125,000	120,000	5,18	55	NTN
1R110X125X40	110,000	125,000	40,000	2,54	55	NTN
1R110X125X54	110,000	125,000	54,000	3,46	55	NTN
1R110X125X90	110,000	125,000	90,000	1,96	55	NTN
1R114.3X139.6X160	114,300	139,600	160,000	12,58	55	NTN
1R11X14X14	11,000	14,000	14,000	0,01	55	NTN
1R120X130X30	120,000	130,000	30,000	1,35	55	NTN
1R120X130X40	120,000	130,000	40,000	1,80	55	NTN
1R120X135X45	120,000	135,000	45,000	3,11	55	NTN
1R120X135X60	120,000	135,000	60,000	4,16	55	NTN
1R12X15X12	12,000	15,000	12,000	0,02	55	NTN
1R12X15X12.5	12,000	15,000	12,500	0,01	55	NTN
1R12X15X16	12,000	15,000	16,000	0,02	55	NTN
1R12X15X16.5	12,000	15,000	16,500	0,02	55	NTN
1R12X15X22.5	12,000	15,000	22,500	0,02	55	NTN
1R12X16X12	12,000	16,000	12,000	0,02	55	NTN
1R12X16X13	12,000	16,000	13,000	0,03	55	NTN
1R12X16X14	12,000	16,000	14,000	0,03	55	NTN
1R12X16X16	12,000	16,000	16,000	0,03	55	NTN
1R12X16X20	12,000	16,000	20,000	0,04	55	NTN
1R12X16X22	12,000	16,000	22,000	0,05	55	NTN
1R12X17X25.5	12,000	17,000	25,500	0,02	55	NTN
1R12X18X16	12,000	18,000	16,000	0,02	55	NTN
1R130X145X32	130,000	145,000	32,000	1,57	55	NTN
1R130X145X35	130,000	145,000	35,000	2,59	55	NTN
1R130X145X63	130,000	145,000	63,000	2,82	55	NTN
1R130X150X50	130,000	150,000	50,000	5,07	55	NTN
1R130X150X52	130,000	150,000	52,000	3,51	55	NTN
1R130X150X67	130,000	150,000	67,000	6,82	55	NTN
1R140X155.3X42	140,000	155,300	42,000	3,60	55	NTN
1R140X155X100	140,000	155,000	100,000	2,71	55	NTN
1R140X155X32	140,000	155,000	32,000	0,92	55	NTN
1R140X155X35	140,000	155,000	35,000	2,78	55	NTN
1R140X155X42	140,000	155,000	42,000	2,22	55	NTN
1R140X160X50	140,000	160,000	50,000	5,42	55	NTN

Reference	d	D	B	Kg	?	Brands
1R140X160X52	140,000	160,000	52,000	5,63	55	NTN
1R140X160X67	140,000	160,000	67,000	4,78	55	NTN
1R14X17X17	14,000	17,000	17,000	0,02	55	NTN
1R150X165X32	150,000	165,000	32,000	0,92	55	NTN
1R150X165X40	150,000	165,000	40,000	2,26	55	NTN
1R150X165X42	150,000	165,000	42,000	3,54	55	NTN
1R150X170X52	150,000	170,000	52,000	2,00	55	NTN
1R150X170X60	150,000	170,000	60,000	4,63	55	NTN
1R15X18X12.5	15,000	18,000	12,500	0,02	55	NTN
1R15X18X13	15,000	18,000	13,000	0,01	55	NTN
1R15X18X16	15,000	18,000	16,000	0,03	55	NTN
1R15X18X16.5	15,000	18,000	16,500	0,02	55	NTN
1R15X18X17.5	15,000	18,000	17,500	0,01	55	NTN
1R15X18X20.5	15,000	18,000	20,500	0,02	55	NTN
1R15X18X25.5	15,000	18,000	25,500	0,02	55	NTN
1R15X18X8.8	15,000	18,000	8,800	0,01	55	NTN
1R15X19X13.5	15,000	19,000	13,500	0,01	55	NTN
1R15X19X16	15,000	19,000	16,000	0,04	55	NTN
1R15X19X16.5	15,000	19,000	16,500	0,03	55	NTN
1R15X19X19	15,000	19,000	19,000	0,02	55	NTN
1R15X19X20	15,000	19,000	20,000	0,03	55	NTN
1R15X20X12	15,000	20,000	12,000	0,04	55	NTN
1R15X20X13	15,000	20,000	13,000	0,04	55	NTN
1R15X20X14	15,000	20,000	14,000	0,04	55	NTN
1R15X20X18	15,000	20,000	18,000	0,04	55	NTN
1R15X20X20.5	15,000	20,000	20,500	0,02	55	NTN
1R15X20X23	15,000	20,000	23,000	0,07	55	NTN
1R15X20X26	15,000	20,000	26,000	0,05	55	NTN
1R15X20X30.5	15,000	20,000	30,500	0,03	55	NTN
1R15X22X20	15,000	22,000	20,000	0,06	55	NTN
1R160X175X40	160,000	175,000	40,000	2,39	55	NTN
1R160X180X60	160,000	180,000	60,000	4,92	55	NTN
1R16X19X14	16,000	19,000	14,000	0,03	55	NTN
1R16X20X13	16,000	20,000	13,000	0,03	55	NTN
1R16X20X16	16,000	20,000	16,000	0,04	55	NTN
1R170X185X45	170,000	185,000	45,000	3,14	55	NTN
1R170X190X60	170,000	190,000	60,000	7,81	55	NTN
1R17X20X16	17,000	20,000	16,000	0,03	55	NTN
1R17X20X16.5	17,000	20,000	16,500	0,03	55	NTN
1R17X20X20	17,000	20,000	20,000	0,03	55	NTN
1R17X20X20.5	17,000	20,000	20,500	0,03	55	NTN
1R17X20X30.5	17,000	20,000	30,500	0,06	55	NTN
1R17X21X16	17,000	21,000	16,000	0,04	55	NTN
1R17X21X20	17,000	21,000	20,000	0,03	55	NTN
1R17X22X11	17,000	22,000	11,000	0,01	55	NTN
1R17X22X13	17,000	22,000	13,000	0,05	55	NTN
1R17X22X14	17,000	22,000	14,000	0,05	55	NTN
1R17X22X16	17,000	22,000	16,000	0,04	55	NTN
1R17X22X18	17,000	22,000	18,000	0,06	55	NTN
1R17X22X20.5	17,000	22,000	20,500	0,05	55	NTN
1R17X22X23	17,000	22,000	23,000	0,08	55	NTN
1R17X22X26	17,000	22,000	26,000	0,06	55	NTN

Reference	d	D	B	Kg	Brands
1R17X22X32	17,000	22,000	32,000	0,04	55 NTN
1R17X24X20	17,000	24,000	20,000	0,07	55 NTN
1R180X195X45	180,000	195,000	45,000	4,57	55 NTN
1R180X205X69	180,000	205,000	69,000	12,06	55 NTN
1R18X22X19	18,000	22,000	19,000	0,04	55 NTN
1R18X25X23	18,000	25,000	23,000	0,09	55 NTN
1R190X210X50	190,000	210,000	50,000	7,17	55 NTN
1R190X215X69	190,000	215,000	69,000	12,54	55 NTN
1R200X220X50	200,000	220,000	50,000	7,50	55 NTN
1R200X225X80	200,000	225,000	80,000	15,39	55 NTN
1R20X24X10	20,000	24,000	10,000	0,01	55 NTN
1R20X24X16	20,000	24,000	16,000	0,05	55 NTN
1R20X24X20	20,000	24,000	20,000	0,06	55 NTN
1R20X24X21.4	20,000	24,000	21,400	0,02	55 NTN
1R20X24X28.5	20,000	24,000	28,500	0,03	55 NTN
1R20X25X12.5	20,000	25,000	12,500	0,03	55 NTN
1R20X25X14	20,000	25,000	14,000	0,06	55 NTN
1R20X25X15.5	20,000	25,000	15,500	0,06	55 NTN
1R20X25X16	20,000	25,000	16,000	0,07	55 NTN
1R20X25X16.5	20,000	25,000	16,500	0,02	55 NTN
1R20X25X17	20,000	25,000	17,000	0,07	55 NTN
1R20X25X18	20,000	25,000	18,000	0,07	55 NTN
1R20X25X20	20,000	25,000	20,000	0,08	55 NTN
1R20X25X20.5	20,000	25,000	20,500	0,08	55 NTN
1R20X25X23	20,000	25,000	23,000	0,06	55 NTN
1R20X25X24.1	20,000	25,000	24,100	0,03	55 NTN
1R20X25X26	20,000	25,000	26,000	0,07	55 NTN
1R20X25X26.5	20,000	25,000	26,500	0,11	55 NTN
1R20X25X30	20,000	25,000	30,000	0,12	55 NTN
1R20X25X32	20,000	25,000	32,000	0,09	55 NTN
1R20X25X38.5	20,000	25,000	38,500	0,16	55 NTN
1R20X28X20	20,000	28,000	20,000	0,14	55 NTN
1R22.1X30X17.5	22,150	30,000	17,500	0,08	55 NTN
1R220X240X50	220,000	240,000	50,000	8,28	55 NTN
1R220X240X54	220,000	240,000	54,000	3,04	55 NTN
1R220X245X80	220,000	245,000	80,000	11,22	55 NTN
1R22X25X16	22,000	25,000	16,000	0,03	55 NTN
1R22X26X10	22,000	26,000	10,000	0,04	55 NTN
1R22X26X16	22,000	26,000	16,000	0,05	55 NTN
1R22X26X17	22,000	26,000	17,000	0,02	55 NTN
1R22X26X20	22,000	26,000	20,000	0,07	55 NTN
1R22X26X20.5	22,000	26,000	20,500	0,07	55 NTN
1R22X26X25	22,000	26,000	25,000	0,06	55 NTN
1R22X28X17	22,000	28,000	17,000	0,10	55 NTN
1R22X28X20	22,000	28,000	20,000	0,07	55 NTN
1R22X28X20.5	22,000	28,000	20,500	0,11	55 NTN
1R22X28X23	22,000	28,000	23,000	0,08	55 NTN
1R22X28X30	22,000	28,000	30,000	0,16	55 NTN
1R22X29X38	22,000	29,000	38,000	0,23	55 NTN
1R22X32X17	22,000	32,000	17,000	0,11	55 NTN
1R240X265X60	240,000	265,000	60,000	18,30	55 NTN
1R240X265X80	240,000	265,000	80,000	6,10	55 NTN

Reference	d	D	B	Kg	Brands
1R242X260X40	242,000	260,000	40,000	2,21	55 NTN
1R25X29X20	25,000	29,000	20,000	0,08	55 NTN
1R25X29X24.5	25,000	29,000	24,500	0,03	55 NTN
1R25X29X28	25,000	29,000	28,000	0,11	55 NTN
1R25X29X30	25,000	29,000	30,000	0,12	55 NTN
1R25X30X12.5	25,000	30,000	12,500	0,06	55 NTN
1R25X30X13	25,000	30,000	13,000	0,02	55 NTN
1R25X30X16	25,000	30,000	16,000	0,08	55 NTN
1R25X30X16.5	25,000	30,000	16,500	0,05	55 NTN
1R25X30X17	25,000	30,000	17,000	0,08	55 NTN
1R25X30X18	25,000	30,000	18,000	0,09	55 NTN
1R25X30X20	25,000	30,000	20,000	0,10	55 NTN
1R25X30X20.5	25,000	30,000	20,500	0,10	55 NTN
1R25X30X23	25,000	30,000	23,000	0,11	55 NTN
1R25X30X25	25,000	30,000	25,000	0,41	55 NTN
1R25X30X26	25,000	30,000	26,000	0,09	55 NTN
1R25X30X26.5	25,000	30,000	26,500	0,13	55 NTN
1R25X30X30	25,000	30,000	30,000	0,15	55 NTN
1R25X30X31	25,000	30,000	31,000	0,05	55 NTN
1R25X30X32	25,000	30,000	32,000	0,16	55 NTN
1R25X30X38.5	25,000	30,000	38,500	0,13	55 NTN
1R25X30X80	25,000	30,000	80,000	0,27	55 NTN
1R25X30X85	25,000	30,000	85,000	0,29	55 NTN
1R25X32X15	25,000	32,000	15,000	0,10	55 NTN
1R25X32X22	25,000	32,000	22,000	0,16	55 NTN
1R25X32X26.5	25,000	32,000	26,500	0,18	55 NTN
1R25X32X30.5	25,000	32,000	30,500	0,22	55 NTN
1R25X32X36	25,000	32,000	36,000	0,18	55 NTN
1R260X285X120	260,000	285,000	120,000	9,84	55 NTN
1R260X285X60	260,000	285,000	60,000	9,82	55 NTN
1R260X290X100	260,000	290,000	100,000	9,94	55 NTN
1R26X35X35X	26,000	35,000	35,000	0,24	55 NTN
1R27.4X32X25.8	27,400	32,000	25,800	0,04	55 NTN
1R27X32X34	27,000	32,000	34,000	0,06	55 NTN
1R27X32X38	27,000	32,000	38,000	0,20	55 NTN
1R27X32X39.3	27,000	32,000	39,300	0,14	55 NTN
1R27X32X39.5	27,000	32,000	39,500	0,07	55 NTN
1R28.1X40X17.5	28,120	40,000	17,500	0,08	55 NTN
1R280X305X69	280,000	305,000	69,000	6,77	55 NTN
1R282X300X45	282,000	300,000	45,000	2,89	55 NTN
1R28X31X10	28,000	31,000	10,000	0,02	55 NTN
1R28X32X17	28,000	32,000	17,000	0,05	55 NTN
1R28X32X20	28,000	32,000	20,000	0,09	55 NTN
1R28X32X23	28,000	32,000	23,000	0,07	55 NTN
1R28X32X27	28,000	32,000	27,000	0,12	55 NTN
1R28X32X30	28,000	32,000	30,000	0,09	55 NTN
1R28X35X32	28,000	35,000	32,000	0,26	55 NTN
1R29.8X35X19	29,800	35,000	19,000	0,08	55 NTN
1R29X32X13	29,000	32,000	13,000	0,02	55 NTN
1R29X33X25.8	29,000	33,000	25,800	0,04	55 NTN
1R30.1X40X27	30,120	40,000	27,000	0,11	55 NTN
1R300X330X80	300,000	330,000	80,000	27,24	55 NTN

Reference	d	D	B	Kg	?	Brands
1R30X35X12.5	30,000	35,000	12,500	0,05	55	NTN
1R30X35X13	30,000	35,000	13,000	0,05	55	NTN
1R30X35X16	30,000	35,000	16,000	0,06	55	NTN
1R30X35X16.5	30,000	35,000	16,500	0,07	55	NTN
1R30X35X17	30,000	35,000	17,000	0,10	55	NTN
1R30X35X18	30,000	35,000	18,000	0,11	55	NTN
1R30X35X20	30,000	35,000	20,000	0,12	55	NTN
1R30X35X20.5	30,000	35,000	20,500	0,08	55	NTN
1R30X35X21	30,000	35,000	21,000	0,08	55	NTN
1R30X35X23	30,000	35,000	23,000	0,09	55	NTN
1R30X35X25	30,000	35,000	25,000	0,05	55	NTN
1R30X35X26	30,000	35,000	26,000	0,10	55	NTN
1R30X35X27.1	30,000	35,000	27,100	0,16	55	NTN
1R30X35X29	30,000	35,000	29,000	0,06	55	NTN
1R30X35X30	30,000	35,000	30,000	0,18	55	NTN
1R30X35X31.4	30,000	35,000	31,400	0,19	55	NTN
1R30X35X32	30,000	35,000	32,000	0,13	55	NTN
1R30X35X33.5	30,000	35,000	33,500	0,13	55	NTN
1R30X35X35	30,000	35,000	35,000	0,14	55	NTN
1R30X35X36.5	30,000	35,000	36,500	0,15	55	NTN
1R30X35X38	30,000	35,000	38,000	0,23	55	NTN
1R30X36X24	30,000	36,000	24,000	0,06	55	NTN
1R30X36X28	30,000	36,000	28,000	0,07	55	NTN
1R30X37X18	30,000	37,000	18,000	0,05	55	NTN
1R30X37X22	30,000	37,000	22,000	0,12	55	NTN
1R30X38X20	30,000	38,000	20,000	0,13	55	NTN
1R30X38X28	30,000	38,000	28,000	0,27	55	NTN
1R30X40X17.5	30,000	40,000	17,500	0,07	55	NTN
1R30X40X27	30,000	40,000	27,000	0,22	55	NTN
1R31.7X38X30	31,750	38,000	30,000	0,08	55	NTN
1R320X350X80	320,000	350,000	80,000	29,40	55	NTN
1R32X35X25	32,000	35,000	25,000	0,09	55	NTN
1R32X36X11	32,000	36,000	11,000	0,02	55	NTN
1R32X37X20	32,000	37,000	20,000	0,12	55	NTN
1R32X37X25.5	32,000	37,000	25,500	0,16	55	NTN
1R32X37X30	32,000	37,000	30,000	0,20	55	NTN
1R32X37X35	32,000	37,000	35,000	0,22	55	NTN
1R32X38X30	32,000	38,000	30,000	0,22	55	NTN
1R32X38X32	32,000	38,000	32,000	0,16	55	NTN
1R32X40X20	32,000	40,000	20,000	0,21	55	NTN
1R32X40X27	32,000	40,000	27,000	0,19	55	NTN
1R32X40X30.5	32,000	40,000	30,500	0,31	55	NTN
1R32X40X30.6	32,000	40,000	30,650	0,11	55	NTN
1R32X40X36	32,000	40,000	36,000	0,38	55	NTN
1R332X350X46	332,000	350,000	46,000	3,46	55	NTN
1R33X39X32	33,000	39,000	32,000	0,16	55	NTN
1R33X40X25	33,000	40,000	25,000	0,08	55	NTN
1R34.6X40X32	34,667	40,000	32,000	0,16	55	NTN
1R34.6X40X43	34,667	40,000	43,000	0,21	55	NTN
1R34X39X24	34,000	39,000	24,000	0,16	55	NTN
1R34X40X10.6	34,000	40,000	10,600	0,03	55	NTN
1R35X40X12.5	35,000	40,000	12,500	0,06	55	NTN

Reference	d	D	B	Kg	?	Brands
1R35X40X16.5	35,000	40,000	16,500	0,04	55	NTN
1R35X40X17	35,000	40,000	17,000	0,11	55	NTN
1R35X40X20	35,000	40,000	20,000	0,13	55	NTN
1R35X40X20.5	35,000	40,000	20,500	0,14	55	NTN
1R35X40X30	35,000	40,000	30,000	0,21	55	NTN
1R35X40X33.5	35,000	40,000	33,500	0,08	55	NTN
1R35X40X34	35,000	40,000	34,000	0,15	55	NTN
1R35X40X40	35,000	40,000	40,000	0,27	55	NTN
1R35X42X20	35,000	42,000	20,000	0,19	55	NTN
1R35X42X21	35,000	42,000	21,000	0,14	55	NTN
1R35X42X22.5	35,000	42,000	22,500	0,07	55	NTN
1R35X42X23	35,000	42,000	23,000	0,07	55	NTN
1R35X42X27	35,000	42,000	27,000	0,26	55	NTN
1R35X42X36	35,000	42,000	36,000	0,35	55	NTN
1R35X42X37	35,000	42,000	37,000	0,24	55	NTN
1R35X42X40	35,000	42,000	40,000	0,13	55	NTN
1R35X42X80	35,000	42,000	80,000	0,26	55	NTN
1R35X43X22	35,000	43,000	22,000	0,25	55	NTN
1R35X43X33.5	35,000	43,000	33,500	0,13	55	NTN
1R35X48X12.5	35,000	48,000	12,500	0,24	55	NTN
1R36.1X50X25.5	36,100	50,000	25,500	0,17	55	NTN
1R36.2X44.4X30.8	36,200	44,450	30,800	0,38	55	NTN
1R360X400X118	360,000	400,000	118,000	22,00	55	NTN
1R36X40X11.5	36,000	40,000	12,000	0,04	55	NTN
1R36X40X12	36,000	40,000	12,000	0,02	55	NTN
1R36X44X26	36,000	44,000	26,000	0,30	55	NTN
1R37.8X43X30	37,800	43,000	30,020	0,16	55	NTN
1R38X43X20	38,000	43,000	20,000	0,15	55	NTN
1R38X43X26	38,000	43,000	26,020	0,13	55	NTN
1R38X43X30	38,000	43,000	30,000	0,21	55	NTN
1R39.3X45X22.5	39,300	45,000	22,500	0,20	55	NTN
1R39.3X45X24.5	39,300	45,000	24,500	0,22	55	NTN
1R39.5X45X28	39,500	45,000	28,000	0,08	55	NTN
1R39.5X45X32	39,500	45,000	32,000	0,27	55	NTN
1R40X45X11.5	40,000	45,000	11,500	0,03	55	NTN
1R40X45X12	40,000	45,000	12,000	0,06	55	NTN
1R40X45X16.5	40,000	45,000	16,500	0,04	55	NTN
1R40X45X17	40,000	45,000	17,000	0,13	55	NTN
1R40X45X20	40,000	45,000	20,000	0,15	55	NTN
1R40X45X20.5	40,000	45,000	20,500	0,16	55	NTN
1R40X45X22	40,000	45,000	22,000	0,06	55	NTN
1R40X45X22.8	40,000	45,000	22,800	0,06	55	NTN
1R40X45X25	40,000	45,000	25,000	0,13	55	NTN
1R40X45X25.5	40,000	45,000	25,500	0,20	55	NTN
1R40X45X26.5	40,000	45,000	26,500	0,07	55	NTN
1R40X45X30	40,000	45,000	30,000	0,23	55	NTN
1R40X45X32.5	40,000	45,000	32,500	0,08	55	NTN
1R40X45X34	40,000	45,000	34,000	0,26	55	NTN
1R40X45X40	40,000	45,000	40,000	0,21	55	NTN
1R40X45X53.8	40,000	45,000	53,800	0,42	55	NTN
1R40X45X59	40,000	45,000	59,000	0,31	55	NTN
1R40X45X65	40,000	45,000	65,000	0,17	55	NTN

Reference	d	D	B	Kg	Brands
1R40X46X30	40,000	46,000	30,000	0,10	55 NTN
1R40X48X22	40,000	48,000	22,000	0,28	55 NTN
1R40X48X23	40,000	48,000	23,000	0,29	55 NTN
1R40X48X30	40,000	48,000	30,000	0,38	55 NTN
1R40X48X37	40,000	48,000	37,000	0,48	55 NTN
1R40X48X40	40,000	48,000	40,000	0,51	55 NTN
1R40X50X20	40,000	50,000	20,000	0,32	55 NTN
1R40X50X22	40,000	50,000	22,000	0,23	55 NTN
1R40X50X25	40,000	50,000	25,000	0,14	55 NTN
1R41.2X50.8X38.3	41,275	50,800	38,350	0,41	55 NTN
1R42X47X20	42,000	47,000	20,000	0,16	55 NTN
1R42X47X30	42,000	47,000	30,000	0,24	55 NTN
1R43X48X24.5	43,000	48,000	24,500	0,20	55 NTN
1R43X52X32	43,000	52,000	32,000	0,16	55 NTN
1R440X490X160	440,000	490,000	160,000	93,00	55 NTN
1R45.4X55X30	45,400	50,000	30,000	0,34	55 NTN
1R45.7X78X47.1	45,700	78,000	47,150	3,48	55 NTN
1R45.7X90X50.7	45,700	90,000	50,750	5,40	55 NTN
1R45X50X17.5	45,000	50,000	17,500	0,10	55 NTN
1R45X50X20	45,000	50,000	20,000	0,11	55 NTN
1R45X50X25	45,000	50,000	25,000	0,21	55 NTN
1R45X50X25.5	45,000	50,000	25,500	0,22	55 NTN
1R45X50X32	45,000	50,000	32,000	0,09	55 NTN
1R45X50X35	45,000	50,000	35,000	0,30	55 NTN
1R45X50X40	45,000	50,000	40,000	0,35	55 NTN
1R45X52X22	45,000	52,000	22,000	0,27	55 NTN
1R45X52X23	45,000	52,000	23,000	0,19	55 NTN
1R45X52X30	45,000	52,000	30,000	0,24	55 NTN
1R45X52X33	45,000	52,000	33,000	0,14	55 NTN
1R45X52X40	45,000	52,000	40,000	0,49	55 NTN
1R45X55X20	45,000	55,000	20,000	0,23	55 NTN
1R45X55X22	45,000	55,000	22,000	0,39	55 NTN
1R45X55X40	45,000	55,000	40,000	0,73	55 NTN
1R50.2X57X48.1	50,200	57,000	48,100	0,65	55 NTN
1R50X55X20	50,000	55,000	20,000	0,19	55 NTN
1R50X55X25	50,000	55,000	25,000	0,23	55 NTN
1R50X55X35	50,000	55,000	35,000	0,33	55 NTN
1R50X55X40	50,000	55,000	40,000	0,26	55 NTN
1R50X58.5X45.2	50,000	58,500	45,200	0,78	55 NTN
1R50X58.6X33.1	50,000	58,600	33,100	0,19	55 NTN
1R50X58X22	50,000	58,000	22,000	0,34	55 NTN
1R50X58X23	50,000	58,000	23,000	0,24	55 NTN
1R50X58X30	50,000	58,000	30,000	0,31	55 NTN
1R50X58X40	50,000	58,000	40,000	0,63	55 NTN
1R50X60X20	50,000	60,000	20,000	0,39	55 NTN
1R50X60X25	50,000	60,000	25,000	0,49	55 NTN
1R50X60X28	50,000	60,000	28,000	0,55	55 NTN
1R50X60X40	50,000	60,000	40,000	0,52	55 NTN
1R52X59X46	52,000	59,000	46,000	0,21	55 NTN
1R52X60X46.1	52,000	60,000	46,100	0,50	55 NTN
1R53.1X70X40	53,150	70,000	40,000	0,51	55 NTN
1R53.5X60X46	53,500	60,000	46,000	0,41	55 NTN

Reference	d	D	B	Kg	Brands
1R53.5X78X47.1	53,500	78,000	47,150	2,80	55 NTN
1R54X60X22	54,000	60,000	22,000	0,18	55 NTN
1R55X60X25	55,000	60,000	25,000	0,26	55 NTN
1R55X60X35	55,000	60,000	35,000	0,36	55 NTN
1R55X60X38	55,000	60,000	38,000	0,13	55 NTN
1R55X63X25	55,000	63,000	25,000	0,28	55 NTN
1R55X63X34	55,000	63,000	34,000	0,38	55 NTN
1R55X63X45	55,000	63,000	45,000	0,77	55 NTN
1R55X65X28	55,000	65,000	28,000	0,62	55 NTN
1R55X65X30	55,000	65,000	30,000	0,65	55 NTN
1R55X65X60	55,000	65,000	60,000	0,87	55 NTN
1R55X80X52.2	55,000	80,000	52,200	3,21	55 NTN
1R57.2X69.8X38.3	57,250	69,850	38,350	0,38	55 NTN
1R57X64X41.7	57,000	64,000	41,750	0,66	55 NTN
1R58X70X30.2	58,000	70,000	30,200	0,85	55 NTN
1R58X70X32.2	58,000	70,000	32,200	0,91	55 NTN
1R5X7X10	5,000	7,000	10,000	0,00	55 NTN
1R5X8X12	5,000	8,000	12,000	0,01	55 NTN
1R5X8X16	5,000	8,000	16,000	0,01	55 NTN
1R60.7X73X50.3	60,700	73,000	50,300	1,01	55 NTN
1R60.7X90X40.3	60,700	90,000	40,300	3,27	55 NTN
1R60X64X7.4	60,000	64,000	7,450	0,02	55 NTN
1R60X68X25	60,000	68,000	25,000	0,46	55 NTN
1R60X68X34	60,000	68,000	34,000	0,62	55 NTN
1R60X68X35	60,000	68,000	35,000	0,65	55 NTN
1R60X68X45	60,000	68,000	45,000	0,83	55 NTN
1R60X70X25	60,000	70,000	25,000	0,58	55 NTN
1R60X70X28	60,000	70,000	28,000	0,65	55 NTN
1R60X70X30	60,000	70,000	30,000	0,71	55 NTN
1R60X70X60	60,000	70,000	60,000	0,94	55 NTN
1R60X74X56.5	60,000	74,000	56,500	1,90	55 NTN
1R62.1X74X50	62,150	74,000	50,000	0,47	55 NTN
1R63X90X50.3	63,000	90,000	50,300	3,81	55 NTN
1R64.7X95X41.9	64,700	95,000	41,900	3,72	55 NTN
1R65.3X78X36.3	65,300	78,000	36,300	1,22	55 NTN
1R65X72X25	65,000	72,000	25,000	0,43	55 NTN
1R65X72X34	65,000	72,000	34,000	0,58	55 NTN
1R65X72X45	65,000	72,000	45,000	0,77	55 NTN
1R65X73X25	65,000	73,000	25,000	0,16	55 NTN
1R65X73X35	65,000	73,000	35,000	0,46	55 NTN
1R65X75X28	65,000	75,000	28,000	0,70	55 NTN
1R65X75X60	65,000	75,000	60,000	0,51	55 NTN
1R66X75X40.2	66,000	75,000	40,200	0,92	55 NTN
1R66X80X40.2	66,000	80,000	40,200	1,43	55 NTN
1R67X83X13.5	67,000	83,000	13,500	0,58	55 NTN
1R68X85X38.2	68,000	85,000	38,200	1,83	55 NTN
1R68X90X47	68,000	90,000	47,000	0,99	55 NTN
1R68X90X48	68,000	90,000	48,000	0,99	55 NTN
1R6X10X10	6,000	10,000	10,000	0,01	55 NTN
1R6X10X13	6,000	10,000	13,000	0,01	55 NTN
1R6X7.9X10	6,000	7,900	10,000	0,00	55 NTN
1R6X8X10	6,000	8,000	10,000	0,01	55 NTN

Reference	d	D	B	Kg	?	Brands
1R6X9X12	6,000	9,000	12,000	0,01	55	NTN
1R6X9X16	6,000	9,000	16,000	0,01	55	NTN
1R70.3X85X38.1	70,300	85,000	38,100	1,58	55	NTN
1R70X78X38.7	70,000	78,000	38,750	0,85	55	NTN
1R70X78X47.1	70,000	78,000	47,100	0,68	55	NTN
1R70X80X25	70,000	80,000	25,000	0,67	55	NTN
1R70X80X28	70,000	80,000	28,000	0,25	55	NTN
1R70X80X30	70,000	80,000	30,000	0,81	55	NTN
1R70X80X35	70,000	80,000	35,000	0,94	55	NTN
1R70X80X40	70,000	80,000	40,000	1,08	55	NTN
1R70X80X54	70,000	80,000	54,000	1,47	55	NTN
1R70X80X56	70,000	80,000	56,000	1,52	55	NTN
1R70X80X60	70,000	80,000	60,000	1,08	55	NTN
1R70X80X92	70,000	80,000	92,000	0,85	55	NTN
1R70X85X40.5	70,000	85,000	40,500	1,71	55	NTN
1R70X90X48.3	70,000	90,000	48,300	2,84	55	NTN
1R70X90X50.3	70,000	90,000	50,300	2,92	55	NTN
1R70X90X56.3	70,000	90,000	56,300	3,30	55	NTN
1R70X95X41.9	70,000	95,000	41,900	2,12	55	NTN
1R71X78X53.1	71,000	78,000	53,100	0,67	55	NTN
1R71X85X40	71,000	85,000	40,000	1,60	55	NTN
1R72X90.5X14.5	72,000	90,500	14,500	0,52	55	NTN
1R75X85X25	75,000	85,000	25,000	0,71	55	NTN
1R75X85X30	75,000	85,000	30,000	0,86	55	NTN
1R75X85X35	75,000	85,000	35,000	1,01	55	NTN
1R75X85X40	75,000	85,000	40,000	1,15	55	NTN
1R75X85X54	75,000	85,000	54,000	1,58	55	NTN
1R76X90X50.4	76,000	90,000	50,400	2,15	55	NTN
1R76X90X60.2	76,000	90,000	60,200	2,56	55	NTN
1R79X91X52.5	79,000	91,000	52,500	1,95	55	NTN
1R79X91X63	79,000	91,000	63,000	2,30	55	NTN
1R79X95X52.5	79,000	95,000	52,500	2,70	55	NTN
1R7X10X10.5	7,000	10,000	10,500	0,01	55	NTN
1R7X10X12	7,000	10,000	12,000	0,01	55	NTN
1R7X10X16	7,000	10,000	16,000	0,01	55	NTN
1R7X12X16	7,000	12,000	16,000	0,02	55	NTN
1R7X9X10	7,000	9,000	10,000	0,00	55	NTN
1R80X88X96	80,000	88,000	96,000	0,78	55	NTN
1R80X90X25	80,000	90,000	25,000	0,75	55	NTN
1R80X90X30	80,000	90,000	30,000	0,92	55	NTN
1R80X90X35	80,000	90,000	35,000	1,07	55	NTN
1R80X90X40	80,000	90,000	40,000	1,23	55	NTN
1R80X90X50.3	80,000	90,000	50,300	0,52	55	NTN
1R80X90X54	80,000	90,000	54,000	1,66	55	NTN
1R80X90X57.8	80,000	90,000	57,800	1,18	55	NTN
1R80X90X60	80,000	90,000	60,000	1,88	55	NTN
1R80X95X32	80,000	95,000	32,000	1,00	55	NTN
1R80X95X57.9	80,000	95,000	57,900	1,87	55	NTN
1R81X92X51	81,000	92,000	51,000	0,59	55	NTN
1R81X92X54.1	81,000	92,000	54,100	0,60	55	NTN
1R81X92X67.6	81,000	92,000	67,650	1,57	55	NTN
1R81X95X52.1	81,000	95,000	52,100	0,77	55	NTN

Reference	d	D	B	Kg	?	Brands
1R85X100X32	85,000	100,000	32,000	0,53	55	NTN
1R85X100X35	85,000	100,000	35,000	1,73	55	NTN
1R85X100X46	85,000	100,000	46,000	1,54	55	NTN
1R85X100X63	85,000	100,000	63,000	3,17	55	NTN
1R85X95X26	85,000	95,000	26,000	0,84	55	NTN
1R85X95X30	85,000	95,000	30,000	0,32	55	NTN
1R85X95X36	85,000	95,000	36,000	1,16	55	NTN
1R8X10X11	8,000	10,000	11,000	0,00	55	NTN
1R8X12X10	8,000	12,000	10,000	0,02	55	NTN
1R8X12X10.5	8,000	12,000	10,500	0,01	55	NTN
1R8X12X12	8,000	12,000	12,000	0,02	55	NTN
1R8X12X12.5	8,000	12,000	12,500	0,01	55	NTN
1R8X14X16	8,000	14,000	16,000	0,01	55	NTN
1R90X100X26	90,000	100,000	26,000	0,87	55	NTN
1R90X100X30	90,000	100,000	30,000	1,01	55	NTN
1R90X100X36	90,000	100,000	36,000	1,22	55	NTN
1R90X105X32	90,000	105,000	32,000	1,12	55	NTN
1R90X105X35	90,000	105,000	35,000	1,83	55	NTN
1R90X105X46	90,000	105,000	46,000	2,44	55	NTN
1R90X105X63	90,000	105,000	63,000	3,33	55	NTN
1R95X105X26	95,000	105,000	26,000	0,87	55	NTN
1R95X105X36	95,000	105,000	36,000	1,15	55	NTN
1R95X110X100	95,000	110,000	100,000	1,90	55	NTN
1R95X110X150	95,000	110,000	150,000	2,80	55	NTN
1R95X110X32	95,000	110,000	32,000	0,59	55	NTN
1R95X110X35	95,000	110,000	35,000	1,93	55	NTN
1R95X110X46	95,000	110,000	46,000	0,85	55	NTN
1R95X110X63	95,000	110,000	63,000	3,51	55	NTN
1R9X12X11	9,000	12,000	11,000	0,01	55	NTN
1R9X12X12	9,000	12,000	12,000	0,01	55	NTN
1R9X12X16	9,000	12,000	16,000	0,02	55	NTN
1R9X15X16	9,000	15,000	16,000	0,03	55	NTN
81102	15,000	28,000	9,000	0,06	56	NTN
81103	17,000	30,000	9,000	0,07	56	NTN
81104	20,000	35,000	10,000	0,04	56	NTN
81105	25,000	42,000	11,000	0,10	56	NTN
81106	30,000	47,000	11,000	0,17	56	NTN
81107	35,000	52,000	12,000	0,22	56	NTN
81108	40,000	60,000	13,000	0,32	56	NTN
81109	45,000	65,000	14,000	0,39	56	NTN
81110	50,000	70,000	14,000	0,42	56	NTN
81111	55,000	78,000	16,000	0,26	56	NTN
81111J	55,000	78,000	16,000	0,71	56	NTN
81112	60,000	85,000	17,000	0,77	56	NTN
81112	60,000	85,000	17,000	0,54	56	NTN
81113	65,000	90,000	18,000	0,60	56	NTN
81114	70,000	95,000	18,000	0,96	56	NTN
81115	75,000	100,000	19,000	1,08	56	NTN
81116	80,000	105,000	19,000	1,31	56	NTN
81117	85,000	110,000	19,000	0,81	56	NTN
81118	90,000	120,000	22,000	2,01	56	NTN
81120	100,000	135,000	25,000	1,79	56	NTN

Reference	d	D	B	Kg	?	Brands
81122	110,000	145,000	25,000	3,12	56	NTN
81124	120,000	155,000	25,000	3,48	56	NTN
81126	130,000	170,000	30,000	1,80	56	NTN
81128	140,000	180,000	31,000	5,45	56	NTN
81130	150,000	190,000	31,000	5,81	56	NTN
81132	160,000	200,000	31,000	6,13	56	NTN
81134	170,000	215,000	34,000	7,93	56	NTN
81136	180,000	225,000	34,000	3,06	56	NTN
81140	200,000	250,000	37,000	4,00	56	NTN
81156	280,000	350,000	53,000	11,90	56	NTN
812/500	500,000	670,000	135,000	298,00	56	NTN
81206	30,000	52,000	16,000	0,95	56	NTN
81207	35,000	62,000	18,000	0,25	56	NTN
81208	40,000	68,000	19,000	0,76	56	NTN
81209	45,000	73,000	20,000	0,31	56	NTN
81210	50,000	78,000	22,000	0,85	56	NTN
81211	55,000	90,000	25,000	1,66	56	NTN
81212	60,000	95,000	26,000	1,95	56	NTN
81213	65,000	100,000	27,000	1,55	56	NTN
81214	70,000	105,000	27,000	2,45	56	NTN
81215	75,000	110,000	27,000	2,35	56	NTN
81215J	75,000	110,000	27,000	1,69	56	NTN
81216	80,000	115,000	28,000	1,72	56	NTN
81217	85,000	125,000	31,000	4,20	56	NTN
81218J	90,000	135,000	35,000	3,35	56	NTN
81220	100,000	150,000	38,000	2,56	56	NTN
81222	110,000	160,000	38,000	4,82	56	NTN
81224	120,000	170,000	39,000	7,98	56	NTN
81226	130,000	190,000	45,000	12,60	56	NTN
81228	140,000	200,000	46,000	4,25	56	NTN
81234	170,000	240,000	55,000	17,08	56	NTN
81236	180,000	250,000	56,000	8,76	56	NTN
81268	340,000	460,000	96,000	50,00	56	NTN
87408	40,000	90,000	23,000	0,76	56	NTN
87411	55,000	120,000	29,000	1,72	56	NTN
87417	85,000	170,000	42,000	5,37	56	NTN
87418	90,000	190,000	45,000	19,53	56	NTN
87420	100,000	210,000	50,000	19,00	56	NTN
87426	130,000	270,000	63,000	38,80	56	NTN
89306	30,000	60,000	6,250	0,48	56	NTN
89307	35,000	68,000	20,000	0,68	56	NTN
89308	40,000	78,000	22,000	1,56	56	NTN
89309	45,000	85,000	24,000	2,01	56	NTN
89310	50,000	95,000	27,000	2,73	56	NTN
89311	55,000	105,000	30,000	1,23	56	NTN
89312	60,000	110,000	30,000	3,90	56	NTN
89313	65,000	115,000	30,000	2,86	56	NTN
89314	70,000	125,000	34,000	3,73	56	NTN
89315	75,000	135,000	36,000	6,99	56	NTN
89316	80,000	140,000	36,000	4,90	56	NTN
89317	85,000	150,000	39,000	9,42	56	NTN
89320	100,000	170,000	42,000	4,27	56	NTN





Reference	d	D	B	Kg	?	Brands
89324	120,000	210,000	54,000	17,82	56	NTN
89326	130,000	225,000	58,000	10,80	56	NTN
89328	140,000	240,000	60,000	12,49	56	NTN
AKJ10X23X2	10,000	23,000	2,000	0,01	57	NTN
AKJ12X24X2	12,000	24,000	2,000	0,01	57	NTN
AKJ17X33X2	17,000	33,000	2,000	0,01	57	NTN
AKJ22X37X2	22,000	37,000	2,000	0,02	57	NTN
AKJ24X36X2	24,000	36,000	2,000	0,01	57	NTN
AKJ25X38X2	25,000	38,000	2,000	0,01	57	NTN
AKJ28.5X38.1X1.5	28.575	38,100	1,500	0,01	57	NTN
AKJ28X43X2	28,000	43,000	2,000	0,02	57	NTN
AKJ30X41.9	30,000	41,930	2,000	0,01	57	NTN
AKJ30X48X5.5	30,000	48,000	5,500	0,05	57	NTN
AKJ31X43.4	31,000	43,400	3,000	0,03	57	NTN
AKJ32X44X2	32,000	44,000	2,000	0,02	57	NTN
AKJ32X46X2	32,000	46,000	2,000	0,02	57	NTN
AKJ32X48X2	32,000	48,000	2,000	0,01	57	NTN
AKJ32X54X2.5	32,000	54,000	2,500	0,01	57	NTN
AKJ33X49X2	33,000	49,000	2,000	0,01	57	NTN
AKJ34.5X50.7X2	34,500	50,700	2,000	0,01	57	NTN
AKJ34.6X51.1X2	34,600	51,100	2,000	0,02	57	NTN
AKJ34X53.5X2.5	34,000	53,500	2,500	0,02	57	NTN
AKJ35X47X2	35,000	47,000	2,000	0,02	57	NTN
AKJ36X52X2	36,000	52,000	2,000	0,03	57	NTN
AKJ38X57X2.5	38,000	57,000	2,500	0,03	57	NTN
AKJ39X54X2	39,000	54,000	2,000	0,02	57	NTN
AKJ40X57.7X2	40,000	57,700	2,000	0,03	57	NTN
AKJ40X59X3	40,000	59,000	3,000	0,05	57	NTN
AKJ41.5X68X9	41,500	68,000	9,000	0,19	57	NTN
AKJ41X57.5X2	41,000	57,500	2,000	0,01	57	NTN
AKJ42X58X2	42,000	58,000	2,000	0,03	57	NTN
AKJ42X67X3	42,000	67,000	3,000	0,04	57	NTN
AKJ44.5X60X2	44,500	60,000	2,000	0,03	57	NTN
AKJ44X57.5X2	44,000	57,200	2,000	0,01	57	NTN
AKJ45X65X4	45,000	65,000	4,000	0,05	57	NTN
AKJ50X74X4	50,000	74,000	4,000	0,08	57	NTN
AKJ60X74X2.5	60,000	74,000	2,500	0,02	57	NTN
AKJ60X78.5X2.5	60,000	78,500	2,500	0,03	57	NTN
AKJ62X73X2	62,000	73,000	2,000	0,02	57	NTN
ARN2052	20,000	52,000	46,000	0,50	54	NTN
ARN2557	25,000	57,000	50,000	1,59	54	NTN
ARN3062	30,000	62,000	50,000	1,25	54	NTN
ARN3080	40,000	68,000	66,000	4,62	54	NTN
ARN3570	35,000	70,000	54,000	1,86	54	NTN
ARN3585	45,000	73,000	66,000	3,34	54	NTN
ARN4075	40,000	75,000	54,000	1,02	54	NTN
ARN4090	50,000	78,000	75,000	6,24	54	NTN
ARN45105	45,000	105,000	82,000	3,16	54	NTN
ARN4580	45,000	80,000	60,000	1,23	54	NTN
ARN50110	60,000	95,000	82,000	6,52	54	NTN
ARN5090	50,000	90,000	60,000	1,48	54	NTN
ARN55115	55,000	115,000	82,000	7,22	54	NTN





Reference	d	D	B	Kg		Brands
ARN60120	60,000	120,000	82,000	7,62	54	NTN
ARN65125	75,000	110,000	82,000	4,14	54	NTN
ARN70130	80,000	115,000	82,000	8,50	54	NTN
ARX100X140X17	100,000	140,000	17,000	1,67	59	NTN
ARX10X25X13.9	10,000	25,000	13,900	0,11	59	NTN
ARX10X25X6	10,000	25,000	6,000	0,02	59	NTN
ARX10X35X42	10,000	35,000	42,000	0,23	59	NTN
ARX10X60X197	10,000	60,000	197,000	3,09	59	NTN
ARX110X195X38	110,000	195,000	38,000	10,20	59	NTN
ARX115X226X36	115,000	226,000	36,000	9,14	59	NTN
ARX120X292X56	120,000	155,000	56,000	14,00	59	NTN
ARX130X188X28	130,000	188,000	28,000	5,06	59	NTN
ARX14X29.5X4.8	14,000	29,500	4,870	0,05	59	NTN
ARX14X29X4.8	14,000	29,000	4,800	0,02	59	NTN
ARX14X29X5.7	14,000	29,000	5,700	0,05	59	NTN
ARX15X30X12	15,000	30,000	12,000	0,06	59	NTN
ARX15X58X77	15,000	58,000	77,000	1,09	59	NTN
ARX17X70X106	17,000	70,000	106,000	4,55	59	NTN
ARX19.1X50X8.4	19,100	50,000	8,400	0,07	59	NTN
ARX195X235X12.5	195,000	235,000	12,500	10,00	59	NTN
ARX195X235X20	195,000	235,000	20,000	11,00	59	NTN
ARX20X35X7.5	20,000	35,000	7,500	0,06	59	NTN
ARX20X36X6	20,000	36,000	6,000	0,07	59	NTN
ARX20X72X165	20,000	72,000	165,000	0,50	59	NTN
ARX22X48X16	22,000	48,000	16,000	0,28	59	NTN
ARX23.8X44.7X11	23,800	44,700	11,000	0,20	59	NTN
ARX25X45X12	25,000	45,000	12,000	0,16	59	NTN
ARX25X70X153	25,000	70,000	153,000	3,94	59	NTN
ARX280X320X13	280,000	320,000	13,000	1,88	59	NTN
ARX30X106X31	30,000	106,000	31,000	1,93	59	NTN
ARX30X114X172	30,000	114,000	172,000	20,84	59	NTN
ARX30X53X12	30,000	53,000	12,000	0,26	59	NTN
ARX30X58X20	30,000	58,000	20,000	0,26	59	NTN
ARX30X59.9X12	30,000	59,900	12,000	0,32	59	NTN
ARX30X70X116	30,000	70,000	116,000	2,41	59	NTN
ARX30X70X145	30,000	70,000	145,000	3,49	59	NTN
ARX30X70X29	30,000	70,000	29,000	0,70	59	NTN
ARX30X90X311	30,000	90,000	311,000	13,48	59	NTN
ARX32X70X25	32,000	70,000	25,000	0,95	59	NTN
ARX32X72X25	32,000	72,000	25,000	0,97	59	NTN
ARX34X80X28	34,000	80,000	28,000	1,45	59	NTN
ARX35X116X30	35,000	116,000	30,000	1,55	59	NTN
ARX35X160X305	35,000	160,000	305,000	44,74	59	NTN
ARX36X120X184	36,000	120,000	184,000	12,54	59	NTN
ARX36X120X189	36,000	120,000	189,000	12,56	59	NTN
ARX36X120X213	36,000	120,000	213,000	13,98	59	NTN
ARX36X160X94	36,000	160,000	94,000	10,58	59	NTN
ARX38X128X45	38,000	128,000	45,000	3,70	59	NTN
ARX38X80X28.5	38,000	80,000	28,500	0,85	59	NTN
ARX38X92X35	38,000	92,000	35,000	2,76	59	NTN
ARX40X110X23	40,000	110,000	23,000	1,43	59	NTN
ARX40X127X177	40,000	127,000	177,000	11,91	59	NTN

Reference	d	D	B	Kg		Brands
ARX40X132X19	40,000	132,000	19,000	2,01	59	NTN
ARX40X134X34	40,000	134,000	34,000	1,59	59	NTN
ARX40X135X23	40,000	135,000	23,000	2,19	59	NTN
ARX40X140X277	40,000	140,000	277,000	30,01	59	NTN
ARX40X59.9X6.5	40,000	59,900	6,500	0,14	59	NTN
ARX40X68X17.5	40,000	68,000	17,500	0,22	59	NTN
ARX40X68X31	40,000	68,000	31,000	0,93	59	NTN
ARX40X72X20	40,000	72,000	20,000	0,92	59	NTN
ARX43.5X58X5	43,500	58,000	5,000	0,06	59	NTN
ARX43X159X269	43,000	159,000	269,000	37,93	59	NTN
ARX45X105X35	45,000	105,000	35,000	1,90	59	NTN
ARX45X115X44	45,000	115,000	44,000	4,06	59	NTN
ARX45X180X365	45,000	180,000	365,000	66,72	59	NTN
ARX49X90X8.7	49,000	90,000	8,700	0,44	59	NTN
ARX50X160X218.5	50,000	160,000	218,500	69,00	59	NTN
ARX50X160X325	50,000	160,000	325,000	45,18	59	NTN
ARX50X70X9	50,000	70,000	9,000	0,11	59	NTN
ARX55X126X39.5	55,000	126,000	39,500	3,05	59	NTN
ARX55X178X40	55,000	178,000	40,000	6,90	59	NTN
ARX55X178X48	55,000	178,000	48,000	8,28	59	NTN
ARX55X178X50.5	55,000	178,000	50,500	13,15	59	NTN
ARX55X80X16	55,000	80,000	16,000	0,88	59	NTN
ARX56X160X50	56,000	160,000	50,000	5,62	59	NTN
ARX58X87X13.2	58,000	87,000	13,250	0,68	59	NTN
ARX60X133X208	60,000	133,000	208,000	17,64	59	NTN
ARX60X133X52	60,000	133,000	52,000	1,72	59	NTN
ARX60X178X44.5	60,000	178,000	44,500	3,78	59	NTN
ARX60X228X4.5	60,000	228,000	4,500	6,08	59	NTN
ARX65X92X19.5	65,000	92,000	19,500	1,21	59	NTN
ARX68X100X15.5	68,000	100,000	15,500	1,31	59	NTN
ARX70X165X96	70,000	165,000	96,000	12,90	59	NTN
ARX71X130X41	71,000	130,000	41,000	2,93	59	NTN
ARX75X152X28.5	75,000	152,000	28,500	3,00	59	NTN
ARX8X34X56	8,000	34,000	56,000	0,30	59	NTN
ARXJ10X24.5X3.8	10,000	24,500	3,800	0,02	59	NTN
ARXJ12X24X4	12,000	24,000	4,000	0,02	59	NTN
ARXJ18X34.6X5.4	18,000	34,600	5,400	0,02	59	NTN
ARXJ18X34.6X6.2	18,000	34,600	6,200	0,01	59	NTN
ARXJ18X35.4X5.4	18,000	35,400	5,400	0,03	59	NTN
ARXJ18X35.4X6.2	18,000	35,400	6,200	0,02	59	NTN
ARXJ18X35.8X5.4	18,000	35,800	5,400	0,01	59	NTN
ARXJ18X35X5.4	18,000	35,000	5,400	0,03	59	NTN
ARXJ18X35X6.2	18,000	35,000	6,200	0,01	59	NTN
ARXJ18X38.9X6.6	18,000	38,900	6,600	0,07	59	NTN
ARXJ20X35X2.8	20,000	35,000	2,800	0,02	59	NTN
ARXJ20X38.7X2.8	20,000	38,700	2,800	0,03	59	NTN
ARXJ22.1X40X4.2	22,100	40,000	4,200	0,01	59	NTN
ARXJ22.2X42.3X3.8	22,200	42,300	3,800	0,05	59	NTN
ARXJ22X39X6	22,000	39,000	6,000	0,06	59	NTN
ARXJ23X42X2.8	23,000	42,000	2,800	0,04	59	NTN
ARXJ25.4X40.3X2.8	25,400	40,300	2,800	0,02	59	NTN
ARXJ25X42X4.8	25,000	42,000	4,800	0,02	59	NTN

Reference	d	D	B	Kg	?	Brands
ARXJ26.7X40.9X2.8	26,700	40,960	2,800	0,02	59	NTN
ARXJ26X42.6X2.8	26,000	42,600	2,800	0,04	59	NTN
ARXJ28.2X45.1X8.6	28,200	45,100	8,600	0,08	59	NTN
ARXJ28X42.7X3	28,000	42,700	3,000	0,03	59	NTN
ARXJ28X46X4.3	28,000	46,000	4,300	0,02	59	NTN
ARXJ28X51.6X6	28,000	51,600	6,000	0,04	59	NTN
ARXJ29.3X49X8.8	29,300	49,000	8,800	0,10	59	NTN
ARXJ29.8X47X3.8	29,800	47,000	3,800	0,04	59	NTN
ARXJ30.1X43.8X2.8	30,150	43,800	2,800	0,03	59	NTN
ARXJ30X47X3.8	30,000	47,000	3,800	0,01	59	NTN
ARXJ30X48X3.3	30,000	48,000	3,300	0,01	59	NTN
ARXJ30X49X8.8	30,000	49,000	8,800	0,05	59	NTN
ARXJ31X46X3.3	31,000	46,000	3,300	0,03	59	NTN
ARXJ33X52X4	33,000	52,000	4,000	0,07	59	NTN
ARXJ33X57.7X5.8	33,000	57,700	5,800	0,17	59	NTN
ARXJ35.1X54X3.4	35,100	54,000	3,400	0,02	59	NTN
ARXJ35X53X2.8	35,000	53,000	2,800	0,04	59	NTN
ARXJ35X53X3	35,000	53,000	3,000	0,05	59	NTN
ARXJ35X62X16.5	35,000	62,000	16,500	0,07	59	NTN
ARXJ36.4X54X3.3	36,400	54,000	3,300	0,02	59	NTN
ARXJ37.1X52X2.8	37,100	52,000	2,800	0,03	59	NTN
ARXJ37.5X58X4.8	37,500	58,000	4,800	0,06	59	NTN
ARXJ37X56X3.7	37,000	56,000	3,710	0,05	59	NTN
ARXJ37X59X2.8	37,000	59,000	2,800	0,06	59	NTN
ARXJ38.5X53.5X3	38,500	53,500	3,000	0,04	59	NTN
ARXJ38.5X56.5X4.2	38,500	56,500	4,200	0,08	59	NTN
ARXJ38X51.8X2.8	38,000	51,800	2,800	0,04	59	NTN
ARXJ38X57X3.9	38,000	57,000	3,800	0,02	59	NTN
ARXJ38X57X4.2	38,000	57,000	4,200	0,05	59	NTN
ARXJ38X60X7.5	38,000	60,000	7,500	0,15	59	NTN
ARXJ38X69X5.7	38,000	69,000	5,700	0,14	59	NTN
ARXJ39X62.3X4	39,000	62,300	4,000	0,10	59	NTN
ARXJ40.6X61X5.3	40,600	61,000	5,300	0,09	59	NTN
ARXJ40.7X58X4.2	40,700	58,000	4,700	0,02	59	NTN
ARXJ40X54X3	40,000	54,000	3,000	0,05	59	NTN
ARXJ40X60X4	40,000	60,000	4,000	0,03	59	NTN
ARXJ40X62X4	40,000	62,000	4,000	0,07	59	NTN
ARXJ41X57.5X2.8	41,000	57,500	2,800	0,02	59	NTN
ARXJ42X59X5.8	42,000	59,000	5,800	0,11	59	NTN
ARXJ44X57.6X2.6	44,000	57,660	2,630	0,03	59	NTN
ARXJ45.4X64X4.8	45,400	64,000	4,800	0,09	59	NTN
ARXJ48.5X65X4	48,500	65,000	4,000	0,07	59	NTN
ARXJ48.5X66.7X3.6	48,500	66,700	3,600	0,09	59	NTN
ARXJ48X79X5.7	48,000	79,000	5,700	0,14	59	NTN
ARXJ50.6X72X4.8	50,600	72,000	4,800	0,06	59	NTN
ARXJ50X68.6X3.6	50,000	68,600	3,600	0,10	59	NTN
ARXJ54X77.1X3.6	54,000	77,100	3,600	0,08	59	NTN
ARXJ54X77X6	54,000	77,000	6,000	0,22	59	NTN
ARXJ56X73X4.9	56,000	73,000	4,900	0,07	59	NTN
ARXJ57.2X81.5X3.9	57,200	81,550	3,985	0,12	59	NTN
ARXJ58.4X88X5.5	58,400	88,000	5,500	0,27	59	NTN
ARXJ58X86.7X4.7	58,000	86,700	4,780	0,15	59	NTN

Reference	d	D	B	Kg	?	Brands
ARXJ60.8X81.9X7.8	60,800	82,100	7,800	0,04	59	NTN
ARXJ61.4X85X6	61,400	85,000	6,000	0,13	59	NTN
ARXJ61.8X85.6X4.7	61,880	85,600	4,795	0,19	59	NTN
ARXJ61.8X86X3.9	61,880	86,000	3,985	0,12	59	NTN
ARXJ62X95X5.7	62,000	95,000	5,700	0,20	59	NTN
ARXJ63.5X87.8X3.9	63,500	87,800	3,985	0,09	59	NTN
ARXJ65X79.3X2.8	65,000	79,300	2,800	0,07	59	NTN
ARXJ66X89.5X6.6	66,000	89,500	6,600	0,07	59	NTN
ARXJ69X91.2X4.6	69,000	91,250	4,600	0,05	59	NTN
ARXJ73.1X100X4.8	73,130	100,000	4,810	0,22	59	NTN
ARXJ89.7X108X4	89,700	108,000	4,000	0,07	59	NTN
AS100X116X1	100,000	116,000	1,000	0,04	58	NTN
AS1100	10,000	24,000	1,000	0,01	58	NTN
AS1101	12,000	26,000	1,000	0,01	58	NTN
AS1102	15,000	28,000	1,000	0,01	58	NTN
AS1103	17,000	30,000	1,000	0,01	58	NTN
AS1104	20,000	35,000	1,000	0,01	58	NTN
AS1105	25,000	42,000	1,000	0,02	58	NTN
AS1106	30,000	47,000	1,000	0,02	58	NTN
AS1107	35,000	52,000	1,000	0,03	58	NTN
AS1108	40,000	60,000	1,000	0,04	58	NTN
AS1109	45,000	65,000	1,000	0,04	58	NTN
AS1110	50,000	70,000	1,000	0,04	58	NTN
AS1111	55,000	78,000	1,000	0,06	58	NTN
AS1112	60,000	85,000	1,000	0,07	58	NTN
AS1113	65,000	90,000	1,000	0,07	58	NTN
AS1114	70,000	95,000	1,000	0,07	58	NTN
AS1115	75,000	100,000	1,000	0,08	58	NTN
AS1116	80,000	105,000	1,000	0,08	58	NTN
AS1117	85,000	110,000	1,000	0,09	58	NTN
AS1118	90,000	120,000	1,000	0,11	58	NTN
AS1120	100,000	135,000	1,000	0,15	58	NTN
AS1122	110,000	145,000	1,000	0,16	58	NTN
AS1124	120,000	155,000	1,000	0,17	58	NTN
AS1126	130,000	170,000	1,000	0,22	58	NTN
AS1128	140,000	180,000	1,000	0,23	58	NTN
AS1130	150,000	190,000	1,000	0,17	58	NTN
AS1132	160,000	200,000	1,000	0,27	58	NTN
AS13X26X1	13,000	26,000	1,000	0,01	58	NTN
AS16X24.5X1	16,000	24,500	1,000	0,004	58	NTN
AS16X29X1	16,000	29,000	1,000	0,01	58	NTN
AS17X33X1	17,000	33,000	1,000	0,01	58	NTN
AS18X31X1	18,000	31,000	1,000	0,01	58	NTN
AS21X33X2.2	21,000	33,000	2,200	0,02	58	NTN
AS22X38X1	22,000	38,000	1,000	0,01	58	NTN
AS25.5X40X1.8	25,500	40,000	1,800	0,03	58	NTN
AS25.5X40X2.2	25,500	40,000	2,200	0,04	58	NTN
AS26X42X1	26,000	42,000	1,000	0,01	58	NTN
AS28.7X37.8X2.2	28,780	37,850	2,200	0,03	58	NTN
AS29X43X1	29,000	43,000	1,000	0,02	58	NTN
AS30.5X47X1	30,500	47,000	1,000	0,02	58	NTN
AS35X46.5X1.5	35,000	46,500	1,500	0,02	58	NTN

					Brands	
Reference	d	D	B	Kg		
AS35X52X0.8	35,000	52,000	0,800	0,02	58	NTN
AS35X60X1	35,000	60,000	1,000	0,03	58	NTN
AS37X48.9X1.6	37,000	48,900	1,600	0,03	58	NTN
AS37X48.9X1.7	37,000	48,900	1,700	0,01	58	NTN
AS37X48.9X1.8	37,000	48,900	1,800	0,03	58	NTN
AS40X70X1	40,000	70,000	1,000	0,06	58	NTN
AS45X64X1.8	45,000	64,000	1,800	0,05	58	NTN
AS52X76.5X0.8	52,000	76,500	0,800	0,04	58	NTN
AS52X76.5X1	52,000	76,500	1,000	0,03	58	NTN
AS64X91.8X0.8	64,000	91,800	0,800	0,05	58	NTN
AS66X88X1.2	66,000	88,000	1,200	0,05	58	NTN
AS66X88X1.6	66,000	88,000	1,600	0,10	58	NTN
AS66X88X1.8	66,000	88,000	1,800	0,11	58	NTN
AS66X88X2	66,000	88,000	2,000	0,04	58	NTN
AS66X88X2.2	66,000	88,000	2,200	0,05	58	NTN
AXK1100	10,000	24,000	2,000	0,01	57	NTN
AXK1101	12,000	26,000	2,000	0,004	57	NTN
AXK1102	15,000	28,000	2,000	0,01	57	NTN
AXK1103	17,000	30,000	2,000	0,01	57	NTN
AXK1104	20,000	35,000	2,000	0,02	57	NTN
AXK1105	25,000	42,000	2,000	0,02	57	NTN
AXK1106	30,000	47,000	2,000	0,02	57	NTN
AXK1107	35,000	52,000	2,000	0,03	57	NTN
AXK1108	40,000	60,000	3,000	0,05	57	NTN
AXK1109	45,000	65,000	3,000	0,05	57	NTN
AXK1110	50,000	70,000	3,000	0,06	57	NTN
AXK1111	55,000	78,000	3,000	0,08	57	NTN
AXK1112	60,000	85,000	3,000	0,09	57	NTN
AXK1113	65,000	90,000	3,000	0,10	57	NTN
AXK1114	70,000	95,000	4,000	0,10	57	NTN
AXK1115	75,000	100,000	4,000	0,16	57	NTN
AXK1116	80,000	105,000	4,000	0,17	57	NTN
AXK1117	85,000	110,000	4,000	0,17	57	NTN
AXK1118	90,000	120,000	4,000	0,22	57	NTN
AXK1120	100,000	135,000	4,000	0,29	57	NTN
AXK1122	110,000	145,000	4,000	0,31	57	NTN
AXK1124	120,000	155,000	4,000	0,35	57	NTN
AXK1126	130,000	170,000	5,000	0,82	57	NTN
AXK1128	140,000	180,000	5,000	0,87	57	NTN
AXK1130	150,000	190,000	5,000	0,92	57	NTN
AXK1132	160,000	200,000	5,000	0,96	57	NTN
AXN2052	25,000	42,000	40,000	0,39	57	NTN
AXN3570	40,000	60,000	48,000	0,77	57	NTN
AXN5090	50,000	90,000	54,000	4,04	57	NTN
BK0408	4,000	8,000	8,000	0,01	48	NTN
BK0509	5,000	9,000	9,000	0,01	48	NTN
BK0609	6,000	10,000	9,000	0,01	48	NTN
BK0709	7,000	11,000	9,000	0,01	48	NTN
BK0810	8,000	12,000	10,000	0,01	48	NTN
BK0910	9,000	13,000	10,000	0,004	48	NTN
BK0912	9,000	13,000	12,000	0,01	48	NTN
BK1010	10,000	14,000	10,000	0,01	48	NTN

					Brands	
Reference	d	D	B	Kg		
BK1012	10,000	14,000	12,000	0,01	48	NTN
BK1015	10,000	14,000	15,000	0,02	48	NTN
BK1210	12,000	16,000	10,000	0,01	48	NTN
BK1212	12,000	18,000	12,000	0,03	48	NTN
BK1312	13,000	19,000	12,000	0,01	48	NTN
BK1412	14,000	20,000	12,000	0,02	48	NTN
BK1512	15,000	21,000	12,000	0,04	48	NTN
BK1516	15,000	21,000	16,000	0,03	48	NTN
BK1612	16,000	22,000	12,000	0,04	48	NTN
BK1616	16,000	22,000	16,000	0,02	48	NTN
BK1622ZWD	16,000	22,000	22,000	0,05	48	NTN
BK1812	18,000	24,000	12,000	0,02	48	NTN
BK2016	20,000	26,000	16,000	0,07	48	NTN
BK2020	20,000	26,000	20,000	0,05	48	NTN
BK2030ZWD	20,000	26,000	30,000	0,04	48	NTN
BK2212	22,000	28,000	12,000	0,02	48	NTN
BK2220	22,000	28,000	20,000	0,09	48	NTN
BK2516	25,000	32,000	16,000	0,03	48	NTN
BK2520	25,000	32,000	20,000	0,12	48	NTN
BK2820D	28,000	35,000	20,000	0,04	48	NTN
BK3016	30,000	37,000	16,000	0,04	48	NTN
BK3020	30,000	37,000	20,000	0,14	48	NTN
BK3026	30,000	37,000	26,000	0,12	48	NTN
BK3038ZWD	30,000	37,000	38,000	0,08	48	NTN
BK3520	35,000	42,000	20,000	0,06	48	NTN
BK4020	40,000	47,000	20,000	0,19	48	NTN
BKS15X21X15.5	15,000	21,000	15,500	0,04	48	NTN
BKS17X23.8X22.1	17,000	23,862	22,100	0,04	48	NTN
BKS17X23.8X31.6	17,000	23,800	31,600	0,12	48	NTN
BKS19X27X17	19,000	27,000	17,000	0,08	48	NTN
BKS20X28X20	20,000	28,000	20,000	0,03	48	NTN
BKS25X32X22	25,000	32,000	22,000	0,04	48	NTN
CR10X	8,000	15,875	31,800	0,02	44	NTN
CR12H	12,000	19,050	36,500	0,04	44	NTN
CR12X	12,000	19,050	36,500	0,04	44	NTN
CR12XH	12,000	19,050	36,500	0,04	44	NTN
CR14XH	12,000	19,050	36,500	0,04	44	NTN
CR16	13,000	25,400	42,800	0,17	44	NTN
CR16X	11,112	25,400	42,800	0,26	44	NTN
CR16XLL	11,112	25,400	42,800	0,08	44	NTN
CR18	11,112	28,575	42,800	0,09	44	NTN
CR18X	11,112	28,575	42,800	0,13	44	NTN
CR20	16,000	31,750	52,400	0,30	44	NTN
CR20X	16,000	31,750	52,400	0,32	44	NTN
CR22	16,000	34,925	52,400	0,17	44	NTN
CR24	15,875	38,100	61,900	0,24	44	NTN
CR24X	15,875	38,100	61,900	0,24	44	NTN
CR28	25,000	44,450	71,400	0,38	44	NTN
CR28X	25,000	44,450	71,400	0,38	44	NTN
CR32	30,000	50,800	84,100	0,62	44	NTN
CR32X	30,000	50,800	84,100	0,62	44	NTN
CR36X	30,000	57,150	84,100	0,75	44	NTN

Reference	d	D	B	Kg		Brands
CR8	4,762	12,700	23,000	0,01	44	NTN
CR8X	4,762	12,700	27,000	0,01	44	NTN
CRV10XLL	6,350	15,875	27,800	0,02	44	NTN
CRV12X	9,525	19,050	36,500	0,04	44	NTN
CRV12XLL	9,525	19,050	36,500	0,04	44	NTN
CRV14XLL	9,525	22,225	36,500	0,05	44	NTN
CRV16X	11,112	25,400	42,800	0,23	44	NTN
CRV16XLL	11,112	25,400	42,800	0,23	44	NTN
CRV18XLL	11,112	28,575	42,800	0,23	44	NTN
CRV20	12,700	31,750	52,400	0,15	44	NTN
CRV20XLL	12,700	31,750	52,400	0,15	44	NTN
CRV22XLL	12,700	34,925	52,400	0,15	44	NTN
CRV24LL	15,875	38,100	61,900	0,78	44	NTN
CRV24X	15,875	38,100	61,900	0,78	44	NTN
CRV24XLL	15,875	38,100	61,900	0,78	44	NTN
CRV26XLL	15,875	41,275	61,900	0,56	44	NTN
CRV28XLL	19,050	44,450	71,400	0,65	44	NTN
CRV32XLL	22,225	50,800	84,100	1,30	44	NTN
CRV40XLL	25,400	63,500	96,800	1,15	44	NTN
CRV48XLL	31,750	76,200	109,500	5,40	44	NTN
CRV52XLL	31,750	82,550	109,500	2,20	44	NTN
CRV64XLL	38,100	101,600	147,600	6,67	44	NTN
CRV80XLL	50,800	127,000	200,000	13,81	44	NTN
GK14X18X16.8	14,000	18,000	16,800	0,01	40	NTN
GK17X22X21.8	17,000	22,000	21,800	0,03	40	NTN
GK20X26X17	20,000	26,000	17,000	0,04	40	NTN
GK22X26X22.8	22,000	26,000	22,800	0,05	40	NTN
GK25X30X20S	25,000	30,000	19,800	0,03	40	NTN
GK25X30X21.8	25,000	30,000	21,800	0,01	40	NTN
GK25X30X25.8	25,000	30,000	26,000	0,04	40	NTN
GK25X31X21.8	25,000	31,000	21,800	0,08	40	NTN
GK25X31X25.8	25,000	31,000	25,800	0,02	40	NTN
GK26X30X17S	26,000	30,000	17,000	0,04	40	NTN
GK27.5X33.5X21.8	27,500	33,500	21,800	0,05	40	NTN
GK28X34X14	28,000	34,000	14,000	0,07	40	NTN
GK28X34X19.8	28,000	34,000	19,800	0,05	40	NTN
GK28X35X18	28,000	35,000	18,000	0,04	40	NTN
GK30X34X33.8XZW	30,000	34,000	33,800	0,05	40	NTN
GK30X35X24.8	30,000	35,000	24,800	0,05	40	NTN
GK30X36X14	30,000	36,000	13,800	0,03	40	NTN
GK30X37X18	30,000	37,000	17,800	0,03	40	NTN
GK32X36X29.8	32,000	36,000	29,800	0,03	40	NTN
GK32X38X14	32,000	38,000	13,800	0,03	40	NTN
GK33X37X25.8	33,000	37,000	25,800	0,05	40	NTN
GK34X39X36.3	34,000	39,000	36,300	0,08	40	NTN
GK34X40X49.8	34,000	40,000	49,800	0,14	40	NTN
GK35X40X26.8	35,000	40,000	26,800	0,06	40	NTN
GK35X40X28.7	35,000	40,000	28,700	0,07	40	NTN
GK36X41X70.6	36,000	41,000	70,600	0,16	40	NTN
GK37X42X24.8	37,000	42,000	24,800	0,04	40	NTN
GK37X42X27	37,000	42,000	26,800	0,11	40	NTN
GK38X46X32	38,000	46,000	31,800	0,04	40	NTN

Reference	d	D	B	Kg		Brands
GK39X44X25.8	39,000	44,000	25,800	0,07	40	NTN
GK39X44X30.8	39,000	44,000	30,800	0,08	40	NTN
GK40X45X43.8	40,000	45,000	43,800	0,24	40	NTN
GK41X46X21.8	41,000	46,000	21,800	0,06	40	NTN
GK42X47X21.8	42,000	47,000	21,800	0,02	40	NTN
GK42X47X30.8	42,000	47,000	30,800	0,14	40	NTN
GK43X49X23.8	43,000	49,000	23,800	0,08	40	NTN
GK43X49X27.8	43,000	49,000	27,800	0,17	40	NTN
GK45X50X27S	45,000	50,000	26,800	0,08	40	NTN
GK45X52X35.8	45,000	52,000	35,800	0,05	40	NTN
GK47X52X24.8	47,000	52,000	24,800	0,08	40	NTN
GK47X52X26.3	47,000	52,000	26,300	0,07	40	NTN
GK47X54X51.3XZW	47,000	54,000	51,300	0,25	40	NTN
GK47X54X63.3XZW	47,000	54,000	63,300	0,20	40	NTN
GK48X54X39.8	48,000	54,000	39,800	0,16	40	NTN
GK58X65X26.5	58,000	65,000	26,500	0,09	40	NTN
GK65X70X49.1XZW	65,000	70,000	49,100	0,21	40	NTN
GK65X70X62.3XZW	65,000	70,000	62,300	0,40	40	NTN
GK80X88X51.8XZW	80,000	88,000	51,800	0,75	40	NTN
GK90X103X22	90,000	103,000	22,000	0,11	40	NTN
GS81100	10,000	24,000	2,750	0,02	58	NTN
GS81101	12,000	26,000	2,750	0,02	58	NTN
GS81102	16,000	28,000	2,750	0,02	58	NTN
GS81103	18,000	30,000	2,750	0,03	58	NTN
GS81104	21,000	35,000	2,750	0,04	58	NTN
GS81105	26,000	42,000	3,000	0,06	58	NTN
GS81106	32,000	47,000	3,000	0,06	58	NTN
GS81107	37,000	52,000	3,500	0,08	58	NTN
GS81108	42,000	60,000	3,500	0,11	58	NTN
GS81109	47,000	65,000	4,000	0,14	58	NTN
GS81110	52,000	70,000	4,000	0,15	58	NTN
GS81111	57,000	78,000	5,000	0,25	58	NTN
GS81112	62,000	85,000	4,750	0,28	58	NTN
GS81113	67,000	90,000	5,250	0,22	58	NTN
GS81114	72,000	95,000	5,250	0,35	58	NTN
GS81115	77,000	100,000	5,750	0,41	58	NTN
GS81116	82,000	105,000	5,750	0,44	58	NTN
GS81117	87,000	110,000	5,750	0,46	58	NTN
GS81118	92,000	120,000	6,500	0,69	58	NTN
GS81120	102,000	135,000	7,000	0,97	58	NTN
GS81122	112,000	145,000	7,000	1,11	58	NTN
GS81124	122,000	155,000	7,000	1,13	58	NTN
GS81126	132,000	170,000	9,000	1,85	58	NTN
GS81128	142,000	180,000	9,500	1,39	58	NTN
GS81130	152,000	190,000	9,500	1,47	58	NTN
GS81132	162,000	200,000	9,500	2,34	58	NTN
GS81206	32,000	52,000	4,250	0,08	58	NTN
GS81207	37,000	62,000	5,250	0,23	58	NTN
GS81208	42,000	68,000	5,000	0,25	58	NTN
GS81209	47,000	73,000	5,500	0,10	58	NTN
GS81210	52,000	78,000	6,500	0,39	58	NTN
GS81211	57,000	90,000	7,000	0,61	58	NTN

Reference	d	D	B	Kg	Brands
GS81212	62,000	95,000	7,500	0,69	58 NTN
GS81213	67,000	100,000	8,000	0,78	58 NTN
GS81214	72,000	105,000	8,000	0,84	58 NTN
GS81215	77,000	110,000	8,000	0,88	58 NTN
GS81216	82,000	115,000	8,500	0,99	58 NTN
GS81217	88,000	125,000	9,500	1,34	58 NTN
GS81218	93,000	135,000	10,500	0,90	58 NTN
GS81220	103,000	150,000	11,500	2,45	58 NTN
GS81222	113,000	160,000	11,500	1,76	58 NTN
GS81224	123,000	170,000	12,000	1,99	58 NTN
GS81226	133,000	190,000	13,000	4,29	58 NTN
GS81228	143,000	200,000	13,500	1,60	58 NTN
GS81234	173,000	240,000	16,500	2,80	58 NTN
GS87414	73,000	150,000	12,500	2,59	58 NTN
GS87415	78,000	160,000	13,000	3,10	58 NTN
GS87416	83,000	170,000	14,500	1,96	58 NTN
GS87418	93,000	190,000	16,000	2,65	58 NTN
GS89306	32,000	60,000	6,250	0,19	58 NTN
GS89307	37,000	68,000	7,000	0,40	58 NTN
GS89308	42,000	78,000	7,500	0,58	58 NTN
GS89309	47,000	85,000	8,250	0,74	58 NTN
GS89310	52,000	95,000	9,500	0,72	58 NTN
GS89311	57,000	105,000	10,500	0,98	58 NTN
GS89312	62,000	110,000	10,500	1,04	58 NTN
GS89313	67,000	115,000	10,500	0,37	58 NTN
GS89314	72,000	125,000	12,000	1,51	58 NTN
GS89315	77,000	135,000	12,500	1,84	58 NTN
GS89316	82,000	140,000	12,500	1,93	58 NTN
GS89317	88,000	150,000	13,500	1,20	58 NTN
GS89318	93,000	155,000	13,500	2,51	58 NTN
GS89320	103,000	170,000	14,500	3,19	58 NTN
GS89322	113,000	190,000	16,500	2,32	58 NTN
H20X26X13.8	20,000	26,000	13,800	0,02	40 NTN
H22X29X13.8	22,000	29,000	13,800	0,01	40 NTN
H25X32X15.80	25,000	32,000	15,800	0,01	40 NTN
H25X32X15.85	25,000	32,000	15,800	0,03	40 NTN
H26X32X16.8	26,000	32,000	16,800	0,01	40 NTN
H26X33X15.8	26,000	33,000	15,800	0,03	40 NTN
H30X38X17.8	30,000	38,000	17,800	0,03	40 NTN
H30X45X14	30,000	45,000	14,000	0,04	40 NTN
H32X41X17.8	32,000	41,000	17,800	0,05	40 NTN
H33X41X19.8	33,000	41,000	19,800	0,05	40 NTN
H34X42X19.8	34,000	42,000	19,800	0,02	40 NTN
H34X42X21.8	34,000	42,000	21,800	0,03	40 NTN
H34X43X19.8	34,000	43,000	19,800	0,02	40 NTN
H34X43X20.8	34,000	43,000	20,800	0,05	40 NTN
H36X45X22.8	36,000	45,000	22,800	0,06	40 NTN
H38X47X19.8	38,000	47,000	19,800	0,02	40 NTN
H38X48X22.8	38,000	48,000	22,800	0,05	40 NTN
H40X50X22.8	40,000	50,000	22,800	0,11	40 NTN
HK0306	3,000	6,500	6,000	0,002	47 NTN
HK0408	4,000	8,000	8,000	0,004	47 NTN

Reference	d	D	B	Kg	Brands
HK0509	5,000	9,000	9,000	0,002	47 NTN
HK0609	6,000	10,000	9,000	0,002	47 NTN
HK0709	7,000	11,000	9,000	0,003	47 NTN
HK0810	8,000	12,000	10,000	0,003	47 NTN
HK0910	9,000	13,000	10,000	0,004	47 NTN
HK0912	9,000	13,000	12,000	0,01	47 NTN
HK1010	10,000	14,000	10,000	0,01	47 NTN
HK1010D	10,000	14,000	10,000	0,01	47 NTN
HK1012	10,000	14,000	12,000	0,01	47 NTN
HK1015	10,000	14,000	15,000	0,01	47 NTN
HK1210	12,000	16,000	10,000	0,005	47 NTN
HK1210D	12,000	16,000	10,000	0,01	47 NTN
HK1212	12,000	18,000	12,000	0,01	47 NTN
HK1212D	12,000	18,000	12,000	0,02	47 NTN
HK1214L	12,000	18,000	14,000	0,03	47 NTN
HK1216LL	12,000	18,000	16,000	0,04	47 NTN
HK1312	13,000	19,000	12,000	0,03	47 NTN
HK1312D	13,000	19,000	12,000	0,01	47 NTN
HK1412	14,000	20,000	12,000	0,03	47 NTN
HK1414L	14,000	20,000	14,000	0,04	47 NTN
HK1416	14,000	20,000	16,000	0,04	47 NTN
HK1416LL	14,000	20,000	16,000	0,03	47 NTN
HK1512	15,000	21,000	12,000	0,02	47 NTN
HK1512D	15,000	21,000	12,000	0,03	47 NTN
HK1514L	15,000	21,000	14,000	0,04	47 NTN
HK1516	15,000	21,000	16,000	0,02	47 NTN
HK1516D	15,000	21,000	16,000	0,04	47 NTN
HK1516LL	15,000	21,000	16,000	0,01	47 NTN
HK1516LLD	15,000	21,000	16,000	0,03	47 NTN
HK1522ZWD	15,000	21,000	22,000	0,06	47 NTN
HK1612	16,000	22,000	12,000	0,01	47 NTN
HK1612D	16,000	22,000	12,000	0,03	47 NTN
HK1614L	16,000	22,000	14,000	0,04	47 NTN
HK1616	16,000	22,000	16,000	0,02	47 NTN
HK1616D	16,000	22,000	16,000	0,05	47 NTN
HK1616LL	16,000	22,000	16,000	0,01	47 NTN
HK1622ZWD	16,000	22,000	22,000	0,04	47 NTN
HK1712	17,000	23,000	12,000	0,01	47 NTN
HK1712D	17,000	23,000	12,000	0,01	47 NTN
HK1812	18,000	23,000	12,000	0,03	47 NTN
HK1814L	18,000	24,000	14,000	0,01	47 NTN
HK1816	18,000	24,000	16,000	0,02	47 NTN
HK1816D	18,000	24,000	16,000	0,03	47 NTN
HK1816F	18,000	24,000	16,000	0,03	47 NTN
HK1816LL	18,000	24,000	16,000	0,03	47 NTN
HK2012	20,000	26,000	12,000	0,01	47 NTN
HK2016	20,000	26,000	16,000	0,05	47 NTN
HK2016D	20,000	26,000	16,000	0,06	47 NTN
HK2016LL	20,000	26,000	16,000	0,05	47 NTN
HK2018L	20,000	26,000	18,000	0,02	47 NTN
HK2020	20,000	26,000	20,000	0,05	47 NTN
HK2020D	20,000	26,000	20,000	0,07	47 NTN

Reference	d	D	B	Kg	?	Brands
HK2020LL	20,000	26,000	20,000	0,05	47	NTN
HK2020LLD	20,000	26,000	20,000	0,02	47	NTN
HK2030ZWD	20,000	26,000	30,000	0,11	47	NTN
HK2212	22,000	28,000	12,000	0,03	47	NTN
HK2216	22,000	28,000	16,000	0,06	47	NTN
HK2216D	22,000	28,000	16,000	0,06	47	NTN
HK2216LL	22,000	28,000	16,000	0,06	47	NTN
HK2218L	22,000	28,000	18,000	0,02	47	NTN
HK2220	22,000	28,000	20,000	0,08	47	NTN
HK2220D	22,000	28,000	20,000	0,08	47	NTN
HK2220LL	22,000	28,000	20,000	0,07	47	NTN
HK2512	25,000	32,000	12,000	0,04	47	NTN
HK2516	25,000	32,000	16,000	0,03	47	NTN
HK2516D	25,000	32,000	16,000	0,03	47	NTN
HK2516LL	25,000	32,000	16,000	0,05	47	NTN
HK2516LLD	25,000	32,000	16,000	0,05	47	NTN
HK2518L	25,000	32,000	18,000	0,03	47	NTN
HK2518LD	25,000	32,000	18,000	0,06	47	NTN
HK2520	25,000	32,000	20,000	0,04	47	NTN
HK2520D	25,000	32,000	20,000	0,10	47	NTN
HK2520LL	25,000	32,000	20,000	0,06	47	NTN
HK2526	25,000	32,000	26,000	0,04	47	NTN
HK2526D	25,000	32,000	26,000	0,13	47	NTN
HK2538ZWD	25,000	32,000	38,000	0,19	47	NTN
HK2816	28,000	35,000	16,000	0,06	47	NTN
HK2820	28,000	35,000	20,000	0,04	47	NTN
HK2820D	28,000	35,000	20,000	0,04	47	NTN
HK2820LL	28,000	35,000	20,000	0,10	47	NTN
HK3012	30,000	37,000	12,000	0,07	47	NTN
HK3012D	30,000	37,000	12,000	0,05	47	NTN
HK3016C	30,000	37,000	16,000	0,03	47	NTN
HK3016LL	30,000	37,000	16,000	0,03	47	NTN
HK3018L	30,000	37,000	18,000	0,10	47	NTN
HK3020	30,000	37,000	20,000	0,04	47	NTN
HK3020D	30,000	37,000	20,000	0,12	47	NTN
HK3020LL	30,000	37,000	20,000	0,11	47	NTN
HK3026	30,000	37,000	26,000	0,10	47	NTN
HK3026D	30,000	37,000	26,000	0,16	47	NTN
HK3038ZWD	30,000	37,000	38,000	0,15	47	NTN
HK3512	35,000	42,000	12,000	0,08	47	NTN
HK3516	35,000	42,000	16,000	0,07	47	NTN
HK3516LL	35,000	42,000	16,000	0,07	47	NTN
HK3518L	35,000	42,000	18,000	0,12	47	NTN
HK3520	35,000	42,000	20,000	0,13	47	NTN
HK3520D	35,000	42,000	20,000	0,13	47	NTN
HK3520LL	35,000	42,000	20,000	0,08	47	NTN
HK4012	40,000	47,000	12,000	0,09	47	NTN
HK4016	40,000	47,000	16,000	0,12	47	NTN
HK4016D	40,000	47,000	16,000	0,04	47	NTN
HK4016LL	40,000	47,000	16,000	0,04	47	NTN
HK4018L	40,000	47,000	18,000	0,13	47	NTN
HK4020	40,000	47,000	20,000	0,15	47	NTN

Reference	d	D	B	Kg	?	Brands
HK4020LL	40,000	47,000	20,000	0,05	47	NTN
HK4020LLD	40,000	47,000	20,000	0,10	47	NTN
HK4516	45,000	52,000	16,000	0,05	47	NTN
HK4518L	45,000	52,000	18,000	0,05	47	NTN
HK4520	45,000	52,000	20,000	0,17	47	NTN
HK4520D	45,000	52,000	20,000	0,11	47	NTN
HK4520LL	45,000	52,000	20,000	0,16	47	NTN
HK5020	50,000	58,000	20,000	0,21	47	NTN
HK5022L	50,000	58,000	22,000	0,08	47	NTN
HK5024LL	50,000	58,000	24,000	0,17	47	NTN
HK5024LLD	50,000	58,000	24,000	0,27	47	NTN
HK5025	50,000	58,000	25,000	0,27	47	NTN
HK5025D	50,000	58,000	25,000	0,18	47	NTN
HKS10X14X14M	10,000	14,000	14,000	0,01	47	NTN
HKS10X15X15	10,000	15,000	15,000	0,02	47	NTN
HKS11X16X13M	11,000	16,000	13,000	0,01	47	NTN
HKS12.7X17.4X22.2	12,700	17,400	22,200	0,03	47	NTN
HKS13.5X17.5X10M	13,500	17,500	10,000	0,02	47	NTN
HKS13X19X14	13,000	19,000	14,000	0,03	47	NTN
HKS14.2X19X19	14,288	19,050	19,050	0,01	47	NTN
HKS14X18X10	14,000	18,000	10,000	0,01	47	NTN
HKS14X18X14	14,000	18,000	14,000	0,01	47	NTN
HKS14X20X20	14,000	20,000	20,000	0,06	47	NTN
HKS14X21X9	14,000	21,000	9,000	0,01	47	NTN
HKS14X22X10M	14,000	22,000	10,000	0,01	47	NTN
HKS14X22X12M	14,000	22,000	12,000	0,04	47	NTN
HKS14X22X16M	14,000	22,000	16,000	0,03	47	NTN
HKS15.8X20.6X14.2	15,875	20,638	14,270	0,02	47	NTN
HKS15.8X20.6X15.8	15,875	20,638	15,880	0,02	47	NTN
HKS15X24X13M	15,000	24,000	13,000	0,05	47	NTN
HKS15X24X17M	15,000	24,000	17,000	0,05	47	NTN
HKS17X25X15	17,000	25,000	15,000	0,06	47	NTN
HKS17X25X18	17,000	25,000	18,000	0,07	47	NTN
HKS17X25X20	17,000	25,000	20,000	0,08	47	NTN
HKS19X25.4X15.8	19,000	25,400	15,800	0,03	47	NTN
HKS20X29X18	20,000	29,000	18,000	0,09	47	NTN
HKS21X28X10	21,000	28,000	10,000	0,04	47	NTN
HKS23.3X29.7X9	23,390	29,745	9,000	0,04	47	NTN
HKS25.2X31.1X11.5	25,200	31,120	11,500	0,05	47	NTN
HKS25.4X31.7X21	25,400	31,700	21,000	0,07	47	NTN
HKS25.4X31.7X23	25,400	31,750	23,050	0,07	47	NTN
HKS25X32X14	25,000	32,000	14,000	0,06	47	NTN
HKS25X32X34ZW	25,000	32,000	34,000	0,11	47	NTN
HKS25X33X18	25,000	33,000	18,000	0,10	47	NTN
HKS29X36X18	29,000	36,000	18,000	0,10	47	NTN
HKS30X37X10	30,000	37,000	10,000	0,03	47	NTN
HKS30X37X30	30,000	37,000	30,000	0,06	47	NTN
HKS30X37X45.5ZW	30,000	37,000	45,500	0,27	47	NTN
HKS32X39X34	32,000	39,000	34,000	0,21	47	NTN
HKS32X39X37	32,000	39,000	37,000	0,23	47	NTN
HKS35X42X10	35,000	42,000	10,000	0,04	47	NTN
HKS36X42X12	36,000	42,000	12,000	0,07	47	NTN

Reference	d	D	B	Kg	?	Brands
HKS38.1X47.6X34.9	38,100	47,600	34,900	0,12	47	NTN
HKS38.1X47.6X35.7	38,100	47,625	35,750	0,26	47	NTN
HKS38X48X13	38,000	48,000	13,000	0,14	47	NTN
HKS3X6.5X6	3,000	6,500	6,000	0,001	47	NTN
HKS41X47X12	41,000	47,000	12,000	0,03	47	NTN
HKS42X49X10	42,000	49,000	10,000	0,03	47	NTN
HKS45X52X12	45,000	52,000	12,000	0,10	47	NTN
HKS50X58X12	50,000	58,000	12,000	0,09	47	NTN
HKS50X58X15	50,000	58,000	15,000	0,11	47	NTN
HKS60X68X12	60,000	68,000	12,000	0,05	47	NTN
HKS6X10X8M	6,000	10,000	8,000	0,004	47	NTN
HKS8X12.6X10.5	8,000	12,600	10,500	0,01	47	NTN
HKS8X12X8	8,000	12,000	8,000	0,002	47	NTN
HKS8X12X9M	8,000	12,000	9,000	0,01	47	NTN
HKZ10X19X23	10,000	19,000	23,000	0,09	47	NTN
HKZ10X27.6X29.5	10,000	27,600	29,500	0,14	47	NTN
HKZ22X50.4X17	22,000	50,400	17,000	0,26	47	NTN
HKZ28X74X17	28,000	74,000	17,000	0,32	47	NTN
HKZ4X8X15.8	4,000	8,000	15,800	0,01	47	NTN
HKZ6X17X12	6,000	17,000	12,000	0,01	47	NTN
HMK0812L	8,000	15,000	12,000	0,02	47	NTN
HMK0814LL	8,000	15,000	14,000	0,02	47	NTN
HMK0815	8,000	15,000	15,000	0,03	47	NTN
HMK0820	8,000	15,000	20,000	0,02	47	NTN
HMK0912	9,000	16,000	12,000	0,02	47	NTN
HMK0916	9,000	16,000	16,000	0,01	47	NTN
HMK1010	10,000	17,000	10,000	0,01	47	NTN
HMK1012	10,000	17,000	12,000	0,02	47	NTN
HMK1012L	10,000	17,000	12,000	0,03	47	NTN
HMK1014LL	10,000	17,000	14,000	0,02	47	NTN
HMK1015	10,000	17,000	15,000	0,03	47	NTN
HMK1020	10,000	17,000	20,000	0,05	47	NTN
HMK1212	12,000	19,000	12,000	0,02	47	NTN
HMK1214L	12,000	19,000	14,000	0,01	47	NTN
HMK1215	12,000	19,000	15,000	0,03	47	NTN
HMK1216LL	12,000	19,000	16,000	0,03	47	NTN
HMK1220	12,000	19,000	20,000	0,05	47	NTN
HMK1225	12,000	19,000	25,000	0,07	47	NTN
HMK1416	14,000	22,000	16,000	0,04	47	NTN
HMK1419L	14,000	22,000	19,000	0,02	47	NTN
HMK1420C	14,000	22,000	20,000	0,07	47	NTN
HMK1422LL	14,000	22,000	22,000	0,02	47	NTN
HMK1510	15,000	22,000	10,000	0,03	47	NTN
HMK1512	15,000	22,000	12,000	0,03	47	NTN
HMK1513L	15,000	22,000	13,000	0,03	47	NTN
HMK1515C	15,000	22,000	15,000	0,02	47	NTN
HMK1516LL	15,000	22,000	16,000	0,03	47	NTN
HMK1518L	15,000	22,000	18,000	0,02	47	NTN
HMK1520	15,000	22,000	20,000	0,04	47	NTN
HMK1521LL	15,000	22,000	21,000	0,06	47	NTN
HMK1525	15,000	22,000	25,000	0,03	47	NTN
HMK1616	16,000	24,000	16,000	0,06	47	NTN

Reference	d	D	B	Kg	?	Brands
HMK1620	16,000	24,000	20,000	0,03	47	NTN
HMK1626LL	16,000	24,000	26,000	0,06	47	NTN
HMK1715	17,000	24,000	15,000	0,05	47	NTN
HMK1718L	17,000	24,000	18,000	0,02	47	NTN
HMK1720C	17,000	24,000	20,000	0,07	47	NTN
HMK1721LL	17,000	24,000	21,000	0,07	47	NTN
HMK1813	18,000	25,000	13,000	0,02	47	NTN
HMK1815	18,000	25,000	15,000	0,02	47	NTN
HMK1817	18,000	25,000	17,000	0,04	47	NTN
HMK1819	18,000	25,000	19,000	0,02	47	NTN
HMK1820	18,000	25,000	20,000	0,05	47	NTN
HMK1820L	18,000	25,000	20,000	0,02	47	NTN
HMK1821LL	18,000	25,000	21,000	0,02	47	NTN
HMK1825	18,000	25,000	25,000	0,06	47	NTN
HMK1916	19,000	27,000	16,000	0,05	47	NTN
HMK1919L	19,000	27,000	19,000	0,05	47	NTN
HMK1920	19,000	27,000	20,000	0,03	47	NTN
HMK2015	20,000	27,000	15,000	0,02	47	NTN
HMK2018L	20,000	27,000	18,000	0,07	47	NTN
HMK2020	20,000	27,000	20,000	0,08	47	NTN
HMK2021LL	20,000	27,000	21,000	0,02	47	NTN
HMK2023L	20,000	27,000	23,000	0,03	47	NTN
HMK2025	20,000	27,000	25,000	0,10	47	NTN
HMK2025C	20,000	27,000	25,000	0,10	47	NTN
HMK2026LL	20,000	27,000	26,000	0,07	47	NTN
HMK2030	20,000	27,000	30,000	0,12	47	NTN
HMK2120	21,000	29,000	20,000	0,03	47	NTN
HMK2210	22,000	29,000	10,000	0,03	47	NTN
HMK2218L	22,000	29,000	18,000	0,05	47	NTN
HMK2220	22,000	29,000	20,000	0,09	47	NTN
HMK2221LL	22,000	29,000	21,000	0,03	47	NTN
HMK2225	22,000	29,000	25,000	0,04	47	NTN
HMK2226LL	22,000	29,000	26,000	0,07	47	NTN
HMK2230	22,000	29,000	30,000	0,13	47	NTN
HMK2420	24,000	31,000	20,000	0,06	47	NTN
HMK2420C	24,000	31,000	20,000	0,09	47	NTN
HMK2423L	24,000	31,000	23,000	0,07	47	NTN
HMK2510	25,000	33,000	10,000	0,04	47	NTN
HMK2515	25,000	33,000	15,000	0,03	47	NTN
HMK2515C	25,000	33,000	15,000	0,09	47	NTN
HMK2518L	25,000	33,000	18,000	0,03	47	NTN
HMK2520	25,000	33,000	20,000	0,11	47	NTN
HMK2521LL	25,000	33,000	21,000	0,07	47	NTN
HMK2523L	25,000	33,000	23,000	0,13	47	NTN
HMK2525	25,000	33,000	25,000	0,14	47	NTN
HMK2526LL	25,000	33,000	26,000	0,09	47	NTN
HMK2530	25,000	33,000	30,000	0,17	47	NTN
HMK2620	26,000	34,000	20,000	0,11	47	NTN
HMK2820	28,000	37,000	20,000	0,13	47	NTN
HMK2830	28,000	37,000	30,000	0,20	47	NTN
HMK2920	29,000	38,000	20,000	0,14	47	NTN
HMK3013	30,000	40,000	13,000	0,04	47	NTN

Reference	d	D	B	Kg	Brands
HMK3015	30,000	40,000	15,000	0,13	47 NTN
HMK3020	30,000	40,000	20,000	0,11	47 NTN
HMK3023L	30,000	40,000	23,000	0,06	47 NTN
HMK3025	30,000	40,000	25,000	0,21	47 NTN
HMK3026LL	30,000	40,000	26,000	0,14	47 NTN
HMK3030	30,000	40,000	30,000	0,09	47 NTN
HMK3030D	30,000	40,000	30,000	0,09	47 NTN
HMK3031LL	30,000	40,000	31,000	0,17	47 NTN
HMK3226LL	32,000	42,000	26,000	0,07	47 NTN
HMK3512	35,000	45,000	12,000	0,11	47 NTN
HMK3515	35,000	45,000	15,000	0,14	47 NTN
HMK3518L	35,000	45,000	18,000	0,16	47 NTN
HMK3520	35,000	45,000	20,000	0,12	47 NTN
HMK3525	35,000	45,000	25,000	0,23	47 NTN
HMK3528L	35,000	45,000	28,000	0,08	47 NTN
HMK3530	35,000	45,000	30,000	0,28	47 NTN
HMK3531LL	35,000	45,000	31,000	0,28	47 NTN
HMK3730	37,000	47,000	30,000	0,21	47 NTN
HMK3820	38,000	48,000	20,000	0,20	47 NTN
HMK3825	38,000	48,000	25,000	0,08	47 NTN
HMK3828L	38,000	48,000	28,000	0,28	47 NTN
HMK3830	38,000	48,000	30,000	0,20	47 NTN
HMK3831LL	38,000	48,000	31,000	0,10	47 NTN
HMK4015	40,000	50,000	15,000	0,16	47 NTN
HMK4018L	40,000	50,000	18,000	0,06	47 NTN
HMK4028L	40,000	50,000	28,000	0,10	47 NTN
HMK4030	40,000	50,000	30,000	0,11	47 NTN
HMK4031LL	40,000	50,000	31,000	0,30	47 NTN
HMK4040ZWD	40,000	50,000	40,000	0,43	47 NTN
HMK4520	45,000	55,000	20,000	0,23	47 NTN
HMK4525	45,000	55,000	25,000	0,29	47 NTN
HMK4526LL	45,000	55,000	26,000	0,04	47 NTN
HMK4530	45,000	55,000	30,000	0,25	47 NTN
K100X107X21	100,000	107,000	20,700	0,37	40 NTN
K100X107X31	100,000	107,000	30,700	0,18	40 NTN
K100X108X27	100,000	108,000	26,700	0,19	40 NTN
K100X108X30	100,000	108,000	29,700	0,60	40 NTN
K105X112X21	105,000	112,000	20,700	0,26	40 NTN
K105X112X31	105,000	112,000	30,700	0,19	40 NTN
K105X112X33.8	105,000	112,000	33,800	0,41	40 NTN
K105X113X29.2	105,000	113,000	29,200	0,62	40 NTN
K10X13X10	10,000	13,000	9,800	0,003	40 NTN
K10X13X13	10,000	13,000	12,800	0,01	40 NTN
K10X13X14.8	10,000	13,000	14,800	0,002	40 NTN
K10X14X10	10,000	14,000	9,800	0,01	40 NTN
K10X14X13	10,000	14,000	12,800	0,01	40 NTN
K10X14X8	10,000	14,000	7,800	0,01	40 NTN
K10X14X8.8	10,000	14,000	8,800	0,01	40 NTN
K10X15X7.8	10,000	15,000	7,800	0,01	40 NTN
K10X16X12	10,000	16,000	11,800	0,02	40 NTN
K110X117X24	110,000	117,000	23,700	0,32	40 NTN
K110X118X29.2	110,000	118,000	29,200	0,65	40 NTN





Reference	d	D	B	Kg	Brands
K115X123X27	115,000	123,000	26,700	0,40	40 NTN
K115X125X34	115,000	125,000	33,700	0,66	40 NTN
K11X14X10	11,000	14,000	9,800	0,003	40 NTN
K11X14X9.8X	11,000	14,000	9,800	0,003	40 NTN
K12.7X17.4X19.6	12,700	17,400	19,600	0,03	40 NTN
K120X127X24	120,000	127,000	23,700	0,51	40 NTN
K120X127X34	120,000	127,000	33,700	0,24	40 NTN
K125X133X35	125,000	133,000	34,700	0,28	40 NTN
K12X15X10	12,000	15,000	9,800	0,01	40 NTN
K12X15X13	12,000	15,000	13,000	0,01	40 NTN
K12X15X20ZW	12,000	15,000	19,800	0,01	40 NTN
K12X15X9	12,000	15,000	8,800	0,003	40 NTN
K12X16X10	12,000	16,000	10,000	0,005	40 NTN
K12X16X19.8	12,000	16,000	19,800	0,03	40 NTN
K12X16X8	12,000	16,000	7,800	0,01	40 NTN
K12X16X8.8	12,000	16,000	8,000	0,01	40 NTN
K12X17X13	12,000	17,000	12,800	0,02	40 NTN
K12X17X7.8	12,000	17,000	7,800	0,01	40 NTN
K12X17X9.8	12,000	17,000	9,800	0,02	40 NTN
K12X18X12	12,000	18,000	11,800	0,02	40 NTN
K13.5X16.5X8.3	13,500	16,500	8,300	0,004	40 NTN
K130X138X29.8	130,000	138,000	29,800	0,52	40 NTN
K135X143X35	135,000	143,000	34,700	0,31	40 NTN
K135X145X39.7	135,000	145,000	39,700	1,34	40 NTN
K140X150X33.7	140,000	150,000	33,700	0,77	40 NTN
K145X153X26	145,000	153,000	25,700	0,51	40 NTN
K145X153X28	145,000	153,000	27,700	0,50	40 NTN
K14X17X10	14,000	17,000	9,800	0,01	40 NTN
K14X18X10	14,000	18,000	9,800	0,02	40 NTN
K14X18X13	14,000	18,000	12,800	0,02	40 NTN
K14X18X15	14,000	18,000	14,800	0,02	40 NTN
K14X18X17	14,000	18,000	16,800	0,03	40 NTN
K14X18X39ZW	14,000	18,000	38,800	0,02	40 NTN
K14X19X13	14,000	19,000	12,800	0,01	40 NTN
K14X20X12	14,000	20,000	11,800	0,03	40 NTN
K14X20X17	14,000	20,000	16,800	0,02	40 NTN
K150X160X46	150,000	160,000	45,700	1,78	40 NTN
K155X163X26	155,000	163,000	25,700	0,54	40 NTN
K155X163X36	155,000	163,000	35,700	0,71	40 NTN
K15X18X14	15,000	18,000	13,800	0,01	40 NTN
K15X18X21.8ZW	15,000	18,000	21,800	0,02	40 NTN
K15X19X10	15,000	19,000	9,800	0,02	40 NTN
K15X19X13	15,000	19,000	12,800	0,02	40 NTN
K15X19X17	15,000	19,000	16,800	0,03	40 NTN
K15X19X24ZW	15,000	19,000	23,800	0,04	40 NTN
K15X20X11.8	15,000	20,000	11,800	0,01	40 NTN
K15X20X13	15,000	20,000	12,800	0,02	40 NTN
K15X21X15	15,000	21,000	14,800	0,04	40 NTN
K15X21X21	15,000	21,000	20,800	0,04	40 NTN
K160X170X46	160,000	170,000	45,700	1,19	40 NTN
K165X173X36	165,000	173,000	35,700	1,16	40 NTN
K16X20X10	16,000	20,000	9,800	0,02	40 NTN





Reference	d	D	B	Kg	?	Brands
K16X20X11	16,000	20,000	10,800	0,01	40	NTN
K16X20X13	16,000	20,000	12,800	0,02	40	NTN
K16X20X17	16,000	20,000	16,800	0,03	40	NTN
K16X20X7.8	16,000	20,000	7,800	0,03	40	NTN
K16X22X12	16,000	22,000	11,800	0,03	40	NTN
K16X22X15.8	16,000	22,000	15,800	0,03	40	NTN
K16X22X17	16,000	22,000	16,800	0,02	40	NTN
K16X22X20	16,000	22,000	19,800	0,05	40	NTN
K16X24X19.8	16,000	24,000	19,800	0,05	40	NTN
K17.5X22X15.8	17,500	22,000	15,800	0,03	40	NTN
K175X183X32	175,000	183,000	31,700	0,76	40	NTN
K17X20X8.8	17,000	20,000	8,800	0,004	40	NTN
K17X21X10	17,000	21,000	9,800	0,02	40	NTN
K17X21X13	17,000	21,000	12,800	0,03	40	NTN
K17X21X15	17,000	21,000	14,800	0,03	40	NTN
K17X21X17	17,000	21,000	16,800	0,03	40	NTN
K17X22X15.8	17,000	22,000	15,800	0,04	40	NTN
K17X22X20	17,000	22,000	19,800	0,05	40	NTN
K17X23X13.8	17,000	23,000	13,800	0,04	40	NTN
K17X23X14.8	17,000	23,000	14,800	0,05	40	NTN
K17X23X22.8	17,000	23,000	22,800	0,04	40	NTN
K17X23X9.8	17,000	23,000	9,800	0,01	40	NTN
K17X25X13.8	17,000	25,000	13,800	0,06	40	NTN
K185X195X37	185,000	195,000	36,700	0,57	40	NTN
K18X22X10	18,000	22,000	9,800	0,01	40	NTN
K18X22X13	18,000	22,000	12,800	0,03	40	NTN
K18X22X17	18,000	22,000	16,800	0,03	40	NTN
K18X23X20	18,000	23,000	19,800	0,02	40	NTN
K18X24X12	18,000	24,000	11,800	0,04	40	NTN
K18X24X13	18,000	24,000	12,800	0,01	40	NTN
K18X24X14.8	18,000	24,000	13,000	0,03	40	NTN
K18X24X20	18,000	24,000	19,800	0,06	40	NTN
K18X25X17	18,000	25,000	16,800	0,04	40	NTN
K18X25X22	18,000	25,000	21,800	0,05	40	NTN
K19.2X22.2X5.8	19,220	22,220	5,800	0,005	40	NTN
K195X205X37	195,000	205,000	36,700	1,24	40	NTN
K19X22X9.8	19,000	22,000	9,800	0,01	40	NTN
K19X23X13	19,000	23,000	12,800	0,03	40	NTN
K19X23X17	19,000	23,000	16,800	0,01	40	NTN
K19X24X22	19,000	24,000	22,000	0,06	40	NTN
K19X24X25.5	19,000	24,000	25,500	0,04	40	NTN
K20X24X10	20,000	24,000	9,800	0,02	40	NTN
K20X24X10.6	20,000	24,000	10,600	0,02	40	NTN
K20X24X11	20,000	24,000	10,800	0,02	40	NTN
K20X24X13	20,000	24,000	12,800	0,03	40	NTN
K20X24X16.8	20,000	24,000	16,800	0,02	40	NTN
K20X24X17	20,000	24,000	16,800	0,04	40	NTN
K20X24X9.6	20,000	24,000	9,600	0,02	40	NTN
K20X25X26.3	20,000	25,000	26,300	0,05	40	NTN
K20X26X12	20,000	26,000	11,800	0,04	40	NTN
K20X26X13	20,000	26,000	12,800	0,03	40	NTN
K20X26X20	20,000	26,000	19,800	0,07	40	NTN

Reference	d	D	B	Kg	?	Brands
K20X32X32.3	20,000	32,000	32,300	0,24	40	NTN
K210X220X42	210,000	220,000	41,700	2,25	40	NTN
K21X25X17	21,000	25,000	16,800	0,04	40	NTN
K22.3X26.3X19.8	22,300	26,300	19,800	0,03	40	NTN
K220X230X42	220,000	230,000	41,700	2,37	40	NTN
K22332LL	12,000	23,000	32,000	0,05	40	NTN
K22X26X10	22,000	26,000	9,800	0,01	40	NTN
K22X26X10.6	22,000	26,000	10,600	0,01	40	NTN
K22X26X11	22,000	26,000	10,800	0,01	40	NTN
K22X26X13	22,000	26,000	12,800	0,03	40	NTN
K22X26X14.3	22,000	26,000	14,300	0,01	40	NTN
K22X26X17	22,000	26,000	16,800	0,01	40	NTN
K22X26X9.6	22,000	26,000	9,600	0,02	40	NTN
K22X27X20	22,000	27,000	19,800	0,06	40	NTN
K22X27X28.3	22,000	27,000	28,300	0,08	40	NTN
K22X28X17	22,000	28,000	16,800	0,04	40	NTN
K22X28X22.8	22,000	28,000	22,800	0,08	40	NTN
K22X29X16	22,000	29,000	15,800	0,07	40	NTN
K22X30X11.8	22,000	30,000	11,800	0,04	40	NTN
K22X30X15	22,000	30,000	14,800	0,08	40	NTN
K22X30X16.8	22,000	30,000	16,800	0,09	40	NTN
K22X30X19.8	22,000	30,000	19,800	0,10	40	NTN
K22X32X13.4	22,000	32,000	13,400	0,09	40	NTN
K22X32X25	22,000	32,000	25,000	0,16	40	NTN
K22X32X44.8	22,000	32,000	44,800	0,28	40	NTN
K240X250X42	240,000	250,000	41,700	2,55	40	NTN
K24X28X10	24,000	28,000	9,800	0,02	40	NTN
K24X28X13	24,000	28,000	12,800	0,03	40	NTN
K24X30X17	24,000	30,000	16,800	0,07	40	NTN
K24X30X31ZW	24,000	30,000	30,800	0,08	40	NTN
K25X29X10	25,000	29,000	9,800	0,03	40	NTN
K25X29X13	25,000	29,000	12,800	0,03	40	NTN
K25X29X17	25,000	29,000	16,800	0,05	40	NTN
K25X29X19.8	25,000	29,000	19,800	0,03	40	NTN
K25X30X13	25,000	30,000	12,800	0,05	40	NTN
K25X30X17	25,000	30,000	16,800	0,05	40	NTN
K25X30X18.8	25,000	30,000	18,800	0,04	40	NTN
K25X30X19.8	25,000	30,000	19,800	0,02	40	NTN
K25X30X20	25,000	30,000	19,800	0,07	40	NTN
K25X30X21.8	25,000	30,000	21,800	0,02	40	NTN
K25X30X22.8	25,000	30,000	22,800	0,05	40	NTN
K25X30X23.8	25,000	30,000	23,800	0,05	40	NTN
K25X30X26ZW	25,000	30,000	25,800	0,09	40	NTN
K25X30X39ZW	25,000	30,000	38,800	0,11	40	NTN
K25X31X12.6	25,000	31,000	13,000	0,05	40	NTN
K25X31X13	25,000	31,000	12,800	0,05	40	NTN
K25X31X13.5	25,000	31,000	13,500	0,06	40	NTN
K25X31X14	25,000	31,000	13,800	0,06	40	NTN
K25X31X17	25,000	31,000	16,800	0,07	40	NTN
K25X31X21	25,000	31,000	20,800	0,08	40	NTN
K25X31X23.9	25,000	31,000	23,900	0,09	40	NTN
K25X31X24.4	25,000	31,000	24,420	0,10	40	NTN

Reference	d	D	B	Kg	?	Brands
K25X32X16	25,000	32,000	15,800	0,08	40	NTN
K25X35X19.8	25,000	35,000	19,800	0,08	40	NTN
K25X35X29.8	25,000	35,000	29,800	0,22	40	NTN
K265X280X50	265,000	280,000	49,700	5,30	40	NTN
K26X30X13	26,000	30,000	12,800	0,04	40	NTN
K26X30X17	26,000	30,000	16,800	0,05	40	NTN
K26X31X19.1	26,000	31,000	19,100	0,04	40	NTN
K27X38X17.3	27,000	38,000	17,300	0,09	40	NTN
K28X32X17	28,000	32,000	16,800	0,05	40	NTN
K28X32X21	28,000	32,000	20,800	0,02	40	NTN
K28X32X26.8	28,000	32,000	26,800	0,07	40	NTN
K28X33X13	28,000	33,000	12,800	0,05	40	NTN
K28X33X16.8	28,000	33,000	16,800	0,02	40	NTN
K28X33X17	28,000	33,000	16,800	0,07	40	NTN
K28X33X21.8	28,000	33,000	21,800	0,08	40	NTN
K28X33X26ZW	28,000	33,000	25,800	0,09	40	NTN
K28X33X27	28,000	33,000	26,800	0,10	40	NTN
K28X34X14	28,000	34,000	13,800	0,04	40	NTN
K28X34X17	28,000	34,000	16,800	0,03	40	NTN
K28X35X16	28,000	35,000	15,800	0,06	40	NTN
K28X35X18	28,000	35,000	17,800	0,10	40	NTN
K28X41X25	28,000	41,000	25,000	0,20	40	NTN
K29X34X17	29,000	34,000	16,800	0,05	40	NTN
K29X34X27	29,000	34,000	26,800	0,07	40	NTN
K29X34X27.8	29,000	34,000	27,800	0,11	40	NTN
K29X35X20.3	29,000	35,000	20,300	0,05	40	NTN
K30X34X22.8	30,000	34,000	22,800	0,04	40	NTN
K30X34X29.8ZW	30,000	34,000	29,800	0,03	40	NTN
K30X35X11	30,000	35,000	10,800	0,05	40	NTN
K30X35X13	30,000	35,000	12,800	0,05	40	NTN
K30X35X17	30,000	35,000	16,800	0,07	40	NTN
K30X35X20	30,000	35,000	19,800	0,08	40	NTN
K30X35X22.8	30,000	35,000	22,800	0,04	40	NTN
K30X35X24.8	30,000	35,000	24,800	0,06	40	NTN
K30X35X26ZW	30,000	35,000	25,800	0,07	40	NTN
K30X35X27	30,000	35,000	26,800	0,10	40	NTN
K30X36X12.5	30,000	36,000	12,500	0,06	40	NTN
K30X36X13.4	30,000	36,000	13,400	0,07	40	NTN
K30X37X16	30,000	37,000	15,800	0,09	40	NTN
K30X37X18	30,000	37,000	17,800	0,07	40	NTN
K30X37X20	30,000	37,000	19,800	0,11	40	NTN
K30X37X22.8	30,000	37,000	22,800	0,09	40	NTN
K30X38X18	30,000	38,000	17,800	0,07	40	NTN
K30X38X23.8	30,000	38,000	23,800	0,16	40	NTN
K30X38X29.8	30,000	38,000	29,800	0,19	40	NTN
K30X40X24.8	30,000	40,000	24,800	0,21	40	NTN
K30X43X54.8ZW	30,000	43,000	54,800	0,60	40	NTN
K30X43X62.8ZW	30,000	43,000	62,800	0,28	40	NTN
K31.2X35.2X4.8	31,200	35,200	4,800	0,01	40	NTN
K32X36X15	32,000	36,000	14,800	0,05	40	NTN
K32X37X13	32,000	37,000	12,800	0,05	40	NTN
K32X37X17	32,000	37,000	16,800	0,08	40	NTN

Reference	d	D	B	Kg	?	Brands
K32X37X23.6	32,000	37,000	23,600	0,06	40	NTN
K32X37X23.8	32,000	37,000	23,800	0,09	40	NTN
K32X37X26ZW	32,000	37,000	25,800	0,11	40	NTN
K32X37X27	32,000	37,000	26,800	0,10	40	NTN
K32X37X38.3ZW	32,000	37,000	38,300	0,13	40	NTN
K32X38X26	32,000	38,000	25,800	0,13	40	NTN
K32X38X33.8	32,000	38,000	33,800	0,07	40	NTN
K32X38X35.8ZW	32,000	38,000	35,800	0,07	40	NTN
K32X39X16	32,000	39,000	15,800	0,10	40	NTN
K32X39X18	32,000	39,000	17,800	0,11	40	NTN
K32X39X20	32,000	39,000	19,800	0,12	40	NTN
K32X43X17.3X3	32,000	43,000	17,300	0,10	40	NTN
K32X48X24.8	32,000	48,000	24,800	0,24	40	NTN
K33X38X30.3	33,000	38,000	30,300	0,08	40	NTN
K33X39X22.6	33,000	39,000	22,600	0,05	40	NTN
K34.9X48.9X24.8	34,925	48,925	24,800	0,21	40	NTN
K34.9X50.9X45	34,925	50,925	45,000	0,47	40	NTN
K34X49X15.3	34,000	49,000	15,300	0,09	40	NTN
K35X39X23.8	35,000	39,000	23,800	0,05	40	NTN
K35X39X34ZW	35,000	39,000	34,000	0,04	40	NTN
K35X40X13	35,000	40,000	12,800	0,06	40	NTN
K35X40X17	35,000	40,000	16,800	0,08	40	NTN
K35X40X17.8	35,000	40,000	17,800	0,08	40	NTN
K35X40X19	35,000	40,000	19,000	0,09	40	NTN
K35X40X22.8	35,000	40,000	22,800	0,06	40	NTN
K35X40X26ZW	35,000	40,000	25,800	0,12	40	NTN
K35X40X27	35,000	40,000	26,800	0,04	40	NTN
K35X40X30ZW	35,000	40,000	29,800	0,05	40	NTN
K35X40X35.8ZWS	35,000	40,000	35,800	0,18	40	NTN
K35X41X12	35,000	41,000	12,000	0,05	40	NTN
K35X41X13.6	35,000	41,000	13,600	0,05	40	NTN
K35X41X14	35,000	41,000	13,800	0,05	40	NTN
K35X41X15	35,000	41,000	14,800	0,08	40	NTN
K35X41X23.8	35,000	41,000	23,800	0,13	40	NTN
K35X42X16	35,000	42,000	15,800	0,11	40	NTN
K35X42X18	35,000	42,000	17,800	0,12	40	NTN
K35X42X20	35,000	42,000	19,800	0,14	40	NTN
K35X42X30	35,000	42,000	29,800	0,20	40	NTN
K35X45X24.8	35,000	45,000	24,800	0,17	40	NTN
K35X47X29.8	35,000	47,000	29,800	0,34	40	NTN
K35X55X17.8	35,000	55,000	17,800	0,16	40	NTN
K36X41X21.5	36,000	41,000	21,500	0,11	40	NTN
K36X41X30.3	36,000	41,000	30,300	0,06	40	NTN
K37X42X13	37,000	42,000	12,800	0,02	40	NTN
K37X42X17	37,000	42,000	16,800	0,05	40	NTN
K37X42X23.8	37,000	42,000	23,800	0,06	40	NTN
K37X42X27	37,000	42,000	26,800	0,12	40	NTN
K37X42X27.8	37,000	42,000	27,800	0,08	40	NTN
K37X43X22.6	37,000	43,000	22,600	0,03	40	NTN
K37X44X18	37,000	44,000	17,800	0,08	40	NTN
K37X45X24.8	37,000	45,000	24,800	0,11	40	NTN
K38X43X17	38,000	43,000	16,800	0,06	40	NTN

					Brands	
Reference	d	D	B	Kg		
K38X43X27	38,000	43,000	26,800	0,04	40	NTN
K38X43X28.8	38,000	43,000	28,800	0,05	40	NTN
K38X43X36ZW	38,000	43,000	36,000	0,18	40	NTN
K38X46X32	38,000	46,000	31,800	0,26	40	NTN
K39X44X23.8	39,000	44,000	23,800	0,04	40	NTN
K39X55X24.8	39,000	55,000	24,800	0,27	40	NTN
K3X5.7X4.9	3,000	5,700	4,900	0,001	40	NTN
K3X6X7	3,000	6,000	6,800	0,001	40	NTN
K40X44X34.6ZW	40,000	44,000	34,600	0,10	40	NTN
K40X45X13	40,000	45,000	12,800	0,07	40	NTN
K40X45X17	40,000	45,000	16,800	0,09	40	NTN
K40X45X21	40,000	45,000	20,800	0,11	40	NTN
K40X45X22	40,000	45,000	22,000	0,11	40	NTN
K40X45X27	40,000	45,000	26,800	0,14	40	NTN
K40X45X29.8	40,000	45,000	29,800	0,05	40	NTN
K40X45X31.8ZW	40,000	45,000	31,800	0,05	40	NTN
K40X45X32.6	40,000	45,000	32,600	0,11	40	NTN
K40X45X34.5	40,000	45,000	34,550	0,15	40	NTN
K40X46X16.6	40,000	46,000	16,600	0,04	40	NTN
K40X46X33.3ZW	40,000	46,000	33,300	0,06	40	NTN
K40X47X18	40,000	47,000	17,800	0,09	40	NTN
K40X47X20	40,000	47,000	19,800	0,15	40	NTN
K40X48X20	40,000	48,000	19,800	0,17	40	NTN
K40X48X25	40,000	48,000	24,800	0,07	40	NTN
K40X56X24.8	40,000	56,000	24,800	0,15	40	NTN
K41X46X21.8	41,000	46,000	21,800	0,06	40	NTN
K41X46X22.3	41,000	46,000	22,300	0,13	40	NTN
K41X46X25.8	41,000	46,000	25,800	0,05	40	NTN
K41X46X30.6	41,000	46,000	30,600	0,05	40	NTN
K42X47X17	42,000	47,000	16,800	0,03	40	NTN
K42X47X23.8	42,000	47,000	23,800	0,12	40	NTN
K42X47X27	42,000	47,000	26,800	0,05	40	NTN
K42X47X29.8	42,000	47,000	29,800	0,11	40	NTN
K42X48X14.3	42,000	48,000	14,300	0,10	40	NTN
K42X48X16.6	42,000	48,000	16,600	0,11	40	NTN
K42X50X20	42,000	50,000	19,800	0,18	40	NTN
K43X48X17	43,000	48,000	16,800	0,03	40	NTN
K43X48X18.3	43,000	48,000	18,300	0,07	40	NTN
K43X48X23.3	43,000	48,000	23,300	0,07	40	NTN
K43X48X24	43,000	48,000	24,000	0,08	40	NTN
K43X48X29.8	43,000	48,000	29,800	0,16	40	NTN
K43X48X32.8	43,000	48,000	32,800	0,12	40	NTN
K43X48X35.7	43,000	48,000	35,700	0,12	40	NTN
K43X48X37.8ZW	43,000	48,000	37,800	0,14	40	NTN
K43X50X18	43,000	50,000	17,800	0,15	40	NTN
K44X49X35.7	43,000	49,000	35,700	0,17	40	NTN
K44X54X25.8	44,000	54,000	25,800	0,06	40	NTN
K45X49X19	45,000	49,000	18,800	0,05	40	NTN
K45X50X17	45,000	50,000	16,800	0,10	40	NTN
K45X50X22.3	45,000	50,000	22,300	0,07	40	NTN
K45X50X24.8	45,000	50,000	24,800	0,05	40	NTN
K45X50X25.8	45,000	50,000	25,800	0,02	40	NTN

					Brands	
Reference	d	D	B	Kg		
K45X50X27	45,000	50,000	26,800	0,15	40	NTN
K45X51X26.8	45,000	51,000	26,800	0,04	40	NTN
K45X52X18	45,000	52,000	17,800	0,15	40	NTN
K45X52X21	45,000	52,000	20,800	0,17	40	NTN
K45X53X20	45,000	53,000	19,800	0,13	40	NTN
K45X53X25	45,000	53,000	24,800	0,16	40	NTN
K45X60X24.8	45,000	60,000	24,800	0,16	40	NTN
K45X60X39.8	45,000	60,000	39,800	0,49	40	NTN
K45X63X51.8	45,000	63,000	51,800	1,11	40	NTN
K46X50X17.8	46,000	50,000	17,800	0,03	40	NTN
K47X52X17	47,000	52,000	16,800	0,07	40	NTN
K47X52X23.8	47,000	52,000	23,800	0,13	40	NTN
K47X52X26.3	47,000	52,000	26,300	0,14	40	NTN
K47X52X27	47,000	52,000	26,800	0,10	40	NTN
K47X52X29.8	47,000	52,000	29,800	0,12	40	NTN
K47X53X32	47,000	53,000	32,000	0,08	40	NTN
K48X53X25.8	48,000	53,000	25,800	0,06	40	NTN
K48X53X29.8	48,000	53,000	29,800	0,19	40	NTN
K48X53X36.8ZW	48,000	53,000	36,800	0,08	40	NTN
K48X54X16.3	48,000	54,000	16,300	0,10	40	NTN
K48X54X19	48,000	54,000	18,800	0,14	40	NTN
K48X58X47.8	48,000	58,000	47,800	0,63	40	NTN
K48X58X49.3	48,000	58,000	49,300	0,22	40	NTN
K48X60X62.8ZW	48,000	60,000	62,800	0,90	40	NTN
K4X6X7.8X	4,000	6,000	7,800	0,001	40	NTN
K47X7X7	4,000	7,000	6,800	0,001	40	NTN
K50.8X64.8X44.5	50,800	64,800	44,500	0,53	40	NTN
K50.8X64.8X49.8	50,800	64,800	49,800	0,20	40	NTN
K50.8X70.8X48.8	50,800	70,800	48,800	1,10	40	NTN
K50X55X13.5	50,000	55,000	13,300	0,03	40	NTN
K50X55X20	50,000	55,000	19,800	0,13	40	NTN
K50X55X27	50,000	55,000	26,800	0,17	40	NTN
K50X55X30	50,000	55,000	29,800	0,19	40	NTN
K50X56X19.8	50,000	56,000	19,800	0,05	40	NTN
K50X57X18	50,000	57,000	17,800	0,17	40	NTN
K50X58X20	50,000	58,000	19,800	0,21	40	NTN
K50X58X25	50,000	58,000	24,800	0,26	40	NTN
K50X65X24.8	50,000	65,000	24,800	0,18	40	NTN
K52X58X16.3	52,000	58,000	16,300	0,03	40	NTN
K52X58X23.3	52,000	58,000	23,300	0,06	40	NTN
K52X58X30.6	52,000	58,000	30,600	0,25	40	NTN
K55X59X12.8	55,000	59,000	12,800	0,05	40	NTN
K55X60X17	55,000	60,000	16,800	0,08	40	NTN
K55X60X20	55,000	60,000	19,800	0,14	40	NTN
K55X60X20.8	55,000	60,000	20,800	0,10	40	NTN
K55X60X24.3	55,000	60,000	24,300	0,16	40	NTN
K55X60X30	55,000	60,000	29,800	0,14	40	NTN
K55X60X31.3	55,000	60,000	31,300	0,15	40	NTN
K55X60X36.8	55,000	60,000	36,800	0,26	40	NTN
K55X61X16.8	55,000	61,000	16,800	0,09	40	NTN
K55X61X19	55,000	61,000	19,000	0,12	40	NTN
K55X61X30	55,000	61,000	29,800	0,15	40	NTN

Reference	d	D	B	Kg	Brands
K55X61X33	55,000	61,000	33,000	0,19	40 NTN
K55X62X18	55,000	62,000	17,800	0,18	40 NTN
K55X63X20	55,000	63,000	19,800	0,16	40 NTN
K55X63X25	55,000	63,000	24,800	0,29	40 NTN
K55X63X27.8	55,000	63,000	27,800	0,11	40 NTN
K55X63X32	55,000	63,000	31,800	0,36	40 NTN
K55X65X40.6	55,000	65,000	40,600	0,38	40 NTN
K56X61X33.6	56,000	61,000	33,600	0,16	40 NTN
K56X66X40.8	56,000	66,000	40,800	0,44	40 NTN
K57X64X31.1	57,000	64,000	31,100	0,32	40 NTN
K57X64X33.8	57,000	64,000	33,800	0,23	40 NTN
K58X63X29.8	58,000	63,000	29,800	0,14	40 NTN
K58X63X31.8	58,000	63,000	31,800	0,08	40 NTN
K58X63X34.3ZW	58,000	63,000	34,300	0,07	40 NTN
K58X64X16.3	58,000	64,000	16,300	0,05	40 NTN
K58X64X19	58,000	64,000	18,800	0,06	40 NTN
K58X80X64.2	58,000	80,000	64,200	1,51	40 NTN
K5X8X10	5,000	8,000	9,800	0,002	40 NTN
K5X8X8	5,000	8,000	7,800	0,002	40 NTN
K60X65X20	60,000	65,000	19,800	0,15	40 NTN
K60X65X26.8	60,000	65,000	26,800	0,20	40 NTN
K60X65X30	60,000	65,000	29,800	0,23	40 NTN
K60X66X19	60,000	66,000	18,800	0,12	40 NTN
K60X66X22.8	60,000	66,000	22,800	0,21	40 NTN
K60X66X30	60,000	66,000	29,800	0,17	40 NTN
K60X66X32.8ZW	60,000	66,000	32,800	0,21	40 NTN
K60X68X20	60,000	68,000	19,800	0,25	40 NTN
K60X68X23	60,000	68,000	22,800	0,29	40 NTN
K60X68X25	60,000	68,000	24,800	0,11	40 NTN
K60X68X27	60,000	68,000	26,800	0,23	40 NTN
K60X75X35.8	60,000	75,000	35,800	0,31	40 NTN
K60X75X49.8	60,000	75,000	49,800	0,39	40 NTN
K61X66X20	61,000	66,000	19,800	0,15	40 NTN
K61X66X21.8	61,000	66,000	21,800	0,17	40 NTN
K61X70X8	61,000	70,000	8,000	0,06	40 NTN
K62X70X23.8	62,000	70,000	23,800	0,31	40 NTN
K64X70X16	64,000	70,000	15,800	0,05	40 NTN
K64X70X27.1	64,000	70,000	27,100	0,25	40 NTN
K64X71X36.8	64,000	71,000	36,800	0,14	40 NTN
K64X71X47.6ZW	64,000	71,000	47,600	0,18	40 NTN
K64X72X27.3	64,000	72,000	27,300	0,24	40 NTN
K64X72X31.3	64,000	72,000	31,100	0,40	40 NTN
K65X70X20	65,000	70,000	19,800	0,16	40 NTN
K65X70X27.8	65,000	70,000	27,800	0,23	40 NTN
K65X70X30	65,000	70,000	29,800	0,16	40 NTN
K65X73X23	65,000	73,000	22,800	0,32	40 NTN
K65X73X30	65,000	73,000	29,800	0,40	40 NTN
K65X80X35.5	65,000	80,000	35,500	0,94	40 NTN
K67X73X28.8	67,000	73,000	28,800	0,30	40 NTN
K67X74X21.8	67,000	74,000	21,800	0,09	40 NTN
K67X74X24.3	67,000	74,000	24,300	0,30	40 NTN
K68X73X9.8	68,000	73,000	9,800	0,04	40 NTN





Reference	d	D	B	Kg	Brands
K68X74X20	68,000	74,000	19,800	0,21	40 NTN
K68X74X35ZW	68,000	74,000	34,800	0,11	40 NTN
K68X75X21	68,000	75,000	20,800	0,15	40 NTN
K68X75X23.3	68,000	75,000	23,300	0,10	40 NTN
K68X76X26.8	68,000	76,000	26,800	0,13	40 NTN
K68X76X36.3ZW	68,000	76,000	36,300	0,18	40 NTN
K68X76X38.8ZW	68,000	76,000	38,800	0,19	40 NTN
K68X76X47.8ZW	68,000	76,000	47,800	0,23	40 NTN
K6X10X13	6,000	10,000	12,800	0,004	40 NTN
K6X9X10	6,000	9,000	9,800	0,003	40 NTN
K6X9X7.8	6,000	9,000	7,800	0,002	40 NTN
K6X9X8	6,000	9,000	7,800	0,003	40 NTN
K70X76X19.8	70,000	76,000	19,800	0,22	40 NTN
K70X76X20	70,000	76,000	19,800	0,21	40 NTN
K70X76X30	70,000	76,000	29,800	0,11	40 NTN
K70X78X23	70,000	78,000	22,800	0,12	40 NTN
K70X78X30	70,000	78,000	29,800	0,44	40 NTN
K71X78X27.8	71,000	78,000	27,800	0,22	40 NTN
K71X79X24.2	71,000	79,000	24,200	0,36	40 NTN
K72X78X39.8ZW	72,000	78,000	39,800	0,21	40 NTN
K73X79X20	73,000	79,000	19,800	0,07	40 NTN
K73X79X24.8	73,000	79,000	24,800	0,26	40 NTN
K73X79X30	73,000	79,000	29,800	0,21	40 NTN
K73X81X37.5	73,000	81,000	37,500	0,53	40 NTN
K74X82X21.8	74,000	82,000	21,800	0,34	40 NTN
K74X90X49.8	74,000	90,000	49,800	0,32	40 NTN
K75X81X30	75,000	81,000	29,800	0,23	40 NTN
K75X82X21	75,000	82,000	21,000	0,30	40 NTN
K75X83X23	75,000	83,000	22,800	0,34	40 NTN
K75X83X30	75,000	83,000	29,800	0,31	40 NTN
K76X80X9	76,000	80,000	9,000	0,02	40 NTN
K78X85X23.3	78,000	85,000	23,300	0,11	40 NTN
K78X85X38.2	78,000	85,000	38,200	0,52	40 NTN
K78X85X41.8ZW	78,000	85,000	41,800	0,20	40 NTN
K78X86X35.8	78,000	86,000	35,800	0,38	40 NTN
K7X10X10	7,000	10,000	9,800	0,003	40 NTN
K7X10X8	7,000	10,000	7,800	0,002	40 NTN
K80X86X20	80,000	86,000	19,800	0,08	40 NTN
K80X86X30	80,000	86,000	29,800	0,36	40 NTN
K80X88X25.4	80,000	88,000	25,400	0,42	40 NTN
K80X88X26	80,000	88,000	25,800	0,14	40 NTN
K80X88X27.8	80,000	88,000	27,800	0,30	40 NTN
K80X88X30	80,000	88,000	29,800	0,33	40 NTN
K81102	15,000	28,000	3,500	0,01	57 NTN
K81103	17,000	30,000	3,500	0,01	57 NTN
K81104	20,000	35,000	4,500	0,02	57 NTN
K81105	25,000	42,000	5,000	0,04	57 NTN
K81106	30,000	47,000	5,000	0,04	57 NTN
K81107	35,000	52,000	5,000	0,05	57 NTN
K81108	40,000	60,000	6,000	0,04	57 NTN
K81109	45,000	65,000	6,000	0,06	57 NTN
K81110	50,000	70,000	6,000	0,07	57 NTN





Reference	d	D	B	Kg	?	Brands
K81111	55,000	78,000	6,000	0,14	57	NTN
K81112	60,000	85,000	7,500	0,08	57	NTN
K81113	65,000	90,000	7,500	0,21	57	NTN
K81114	70,000	95,000	7,500	0,22	57	NTN
K81115	75,000	100,000	7,500	0,09	57	NTN
K81116	80,000	105,000	7,500	0,16	57	NTN
K81117	85,000	110,000	7,500	0,26	57	NTN
K81118	90,000	120,000	9,000	0,28	57	NTN
K81120	100,000	135,000	11,000	0,68	57	NTN
K81122	110,000	145,000	11,000	0,73	57	NTN
K81124	120,000	155,000	11,000	0,79	57	NTN
K81126	130,000	170,000	12,000	0,81	57	NTN
K81128	140,000	180,000	12,000	1,29	57	NTN
K81130	150,000	190,000	12,000	1,38	57	NTN
K81132	160,000	200,000	12,000	1,49	57	NTN
K81206	30,000	52,000	7,500	0,11	57	NTN
K81207	35,000	62,000	7,500	0,13	57	NTN
K81208	40,000	68,000	9,000	0,20	57	NTN
K81209	45,000	73,000	9,000	0,23	57	NTN
K81210	50,000	78,000	9,000	0,24	57	NTN
K81211	55,000	90,000	11,000	0,33	57	NTN
K81212	60,000	95,000	11,000	0,44	57	NTN
K81213	65,000	100,000	11,000	0,47	57	NTN
K81214	70,000	105,000	11,000	0,20	57	NTN
K81215	75,000	110,000	11,000	0,35	57	NTN
K81216	80,000	115,000	11,000	0,56	57	NTN
K81217	85,000	125,000	12,000	1,40	57	NTN
K81218J	90,000	120,000	9,000	0,43	57	NTN
K81220	100,000	150,000	15,000	1,60	57	NTN
K81222	110,000	160,000	15,000	1,17	57	NTN
K81224	120,000	170,000	15,000	0,63	57	NTN
K81226	130,000	190,000	19,000	3,07	57	NTN
K81228	140,000	200,000	19,000	2,17	57	NTN
K85X92X26.8	85,000	92,000	26,800	0,27	40	NTN
K85X92X30	85,000	92,000	29,800	0,30	40	NTN
K85X95X34.8	85,000	95,000	34,800	0,25	40	NTN
K86X98X9.8	86,000	98,000	9,800	0,14	40	NTN
K87414	70,000	150,000	11,000	1,33	57	NTN
K88X100X75.5ZW	88,000	100,000	75,500	0,44	40	NTN
K89306	30,000	60,000	5,500	0,13	57	NTN
K89307	35,000	68,000	6,000	0,13	57	NTN
K89308	40,000	78,000	7,000	0,20	57	NTN
K89309	45,000	85,000	7,500	0,36	57	NTN
K89310	50,000	95,000	8,000	0,52	57	NTN
K89311	55,000	105,000	9,000	0,47	57	NTN
K89312	60,000	110,000	9,000	0,49	57	NTN
K89313	65,000	115,000	9,000	0,53	57	NTN
K89314	70,000	125,000	10,000	0,67	57	NTN
K89315	75,000	135,000	11,000	0,93	57	NTN
K89316	80,000	140,000	11,000	1,48	57	NTN
K89317	85,000	150,000	12,000	0,58	57	NTN
K89318	90,000	155,000	12,000	1,83	57	NTN

Reference	d	D	B	Kg	?	Brands
K89320	100,000	170,000	13,000	1,54	57	NTN
K89322	110,000	190,000	15,000	0,16	57	NTN
K89X97X33.5	89,000	97,000	33,500	0,61	40	NTN
K8X11X10	8,000	11,000	9,800	0,004	40	NTN
K8X11X13	8,000	11,000	12,800	0,01	40	NTN
K8X11X8	8,000	11,000	7,800	0,003	40	NTN
K8X11X8.6	8,000	11,000	8,600	0,004	40	NTN
K8X12X10	8,000	12,000	9,800	0,002	40	NTN
K8X12X11	8,000	12,000	11,000	0,01	40	NTN
K8X12X13	8,000	12,000	12,800	0,01	40	NTN
K8X25X21.8	18,000	25,000	21,800	0,04	40	NTN
K90X97X20	90,000	97,000	19,800	0,21	40	NTN
K90X97X24.8	90,000	97,000	24,800	0,39	40	NTN
K90X97X36.8	90,000	97,000	36,800	0,36	40	NTN
K90X98X30	90,000	98,000	29,800	0,36	40	NTN
K91X98X26	91,000	98,000	26,000	0,41	40	NTN
K92X102X25.3	92,000	102,000	25,300	0,42	40	NTN
K95X102X21	95,000	102,000	20,800	0,12	40	NTN
K95X103X45.8	95,000	103,000	45,800	0,59	40	NTN
K97X107X29.8	97,000	107,000	29,800	0,73	40	NTN
K9X12X10	9,000	12,000	9,800	0,004	40	NTN
K9X12X13	9,000	12,000	12,800	0,01	40	NTN
K9X12X32.8	9,000	12,000	32,800	0,02	40	NTN
KBK10X14X12.5	10,000	14,000	12,500	0,02	40	NTN
KBK10X14X14.8	10,000	14,000	14,800	0,01	40	NTN
KBK11X15X12.3	11,000	15,000	12,300	0,01	40	NTN
KBK11X15X15.8	11,000	15,000	15,800	0,02	40	NTN
KBK12X15X14.3	12,000	15,000	14,300	0,01	40	NTN
KBK12X15X16.6	12,000	15,000	16,400	0,02	40	NTN
KBK12X16X14.8	12,000	16,000	14,800	0,02	40	NTN
KBK12X16X15.3	12,000	16,000	15,300	0,02	40	NTN
KBK12X16X15.6	12,000	16,000	15,400	0,02	40	NTN
KBK12X16X16	12,000	16,000	15,800	0,02	40	NTN
KBK12X16X16.4	12,000	16,000	16,400	0,02	40	NTN
KBK13X17X18.1	13,000	17,000	18,100	0,02	40	NTN
KBK14X18X15.8	14,000	18,000	15,800	0,02	40	NTN
KBK14X18X17	14,000	18,000	16,800	0,01	40	NTN
KBK14X18X17.3	14,000	18,000	17,300	0,03	40	NTN
KBK14X18X18.3	14,000	18,000	18,300	0,01	40	NTN
KBK14X18X18.8	14,000	18,000	18,800	0,02	40	NTN
KBK14X18X20	14,000	18,000	19,800	0,03	40	NTN
KBK15X19X16.8	15,000	19,000	16,800	0,01	40	NTN
KBK15X19X17.3	15,000	19,000	17,300	0,03	40	NTN
KBK15X19X18.8	15,000	19,000	18,800	0,02	40	NTN
KBK15X19X19.5	15,000	19,000	19,500	0,01	40	NTN
KBK15X19X19.8	15,000	19,000	19,800	0,04	40	NTN
KBK15X20X17.8	15,000	20,000	17,800	0,04	40	NTN
KBK16X20X17	16,000	20,000	16,800	0,03	40	NTN
KBK16X20X17.3	16,000	20,000	17,300	0,03	40	NTN
KBK16X20X17.8	16,000	20,000	17,800	0,03	40	NTN
KBK16X20X18.8	16,000	20,000	18,800	0,01	40	NTN
KBK16X20X19.8	16,000	20,000	19,600	0,01	40	NTN

Reference	d	D	B	Kg	Brands
KBK16X20X22.8	16,000	20,000	22,800	0,01	40 NTN
KBK16X21X19.6	16,000	21,000	19,600	0,05	40 NTN
KBK17X21X25	17,000	21,000	25,000	0,03	40 NTN
KBK17X22X22	17,000	22,000	22,000	0,04	40 NTN
KBK18X22X21.8	18,000	22,000	21,800	0,05	40 NTN
KBK18X22X22.8	18,000	22,000	22,800	0,05	40 NTN
KBK18X22X23.8	18,000	22,000	23,800	0,05	40 NTN
KBK19X23X21.8	19,000	23,000	21,800	0,03	40 NTN
KBK20X25X29	20,000	25,000	29,000	0,03	40 NTN
KBK22X28X29.9	22,000	28,000	29,900	0,04	40 NTN
KBK38X43X25.8	38,000	43,000	25,800	0,11	40 NTN
KBK44X50X23.8	44,000	50,000	23,800	0,16	40 NTN
KBK7X10X9.8	7,000	10,000	9,800	0,01	40 NTN
KBK8X11X11.8	8,000	11,000	11,800	0,01	40 NTN
KBK8X11X8.8	8,000	11,000	8,800	0,01	40 NTN
KBK9X12X11.7	9,000	12,000	11,500	0,01	40 NTN
KBK9X12X12	9,000	12,000	12,000	0,01	40 NTN
KD203245	20,000	32,000	45,000	0,20	61 NTN
KD203245LL	20,000	32,000	45,000	0,11	61 NTN
KD253745	25,000	37,000	45,000	0,02	61 NTN
KD253745LL	25,000	37,000	45,000	0,36	61 NTN
KD304565	30,000	45,000	65,000	0,53	61 NTN
KD304565LL	30,000	45,000	65,000	0,81	61 NTN
KD355270LL	35,000	52,000	70,000	0,41	61 NTN
KD406080LL	40,000	60,000	80,000	1,86	61 NTN
KD5072100	50,000	72,000	200,000	2,01	61 NTN
KD5072100LL	50,000	72,000	100,000	0,46	61 NTN
KD6085100LL	60,000	85,000	100,000	1,43	61 NTN
KDX125X175X115	125,000	175,000	115,000	7,50	61 NTN
KDX18X26X23	18,000	26,000	23,000	0,09	61 NTN
KDX4X11X23.9	4,000	11,000	23,900	0,03	61 NTN
KH1228	12,000	19,000	28,000	0,05	60 NTN
KH1228LL	12,000	19,000	28,000	0,05	60 NTN
KH1428	14,000	21,000	28,000	0,06	60 NTN
KH1630	16,000	24,000	30,000	0,08	60 NTN
KH1630LL	16,000	24,000	30,000	0,08	60 NTN
KH2030	20,000	28,000	30,000	0,10	60 NTN
KH2030LL	20,000	28,000	30,000	0,10	60 NTN
KH2540	25,000	35,000	40,000	0,19	60 NTN
KH2540LL	25,000	35,000	40,000	0,20	60 NTN
KH3050	30,000	40,000	50,000	0,19	60 NTN
KH3050LL	30,000	40,000	50,000	0,29	60 NTN
KH4060	40,000	52,000	60,000	0,54	60 NTN
KH4060LL	40,000	52,000	60,000	0,36	60 NTN
KH5070	50,000	62,000	70,000	0,74	60 NTN
KH5070LL	50,000	62,000	70,000	0,48	60 NTN
KJ105X119X12.5	105,000	119,000	12,500	0,17	40 NTN
KJ13X16X13.8	13,000	16,000	13,800	0,01	40 NTN
KJ14X18X17.8	14,000	18,000	17,800	0,02	40 NTN
KJ16X20X17	16,000	20,000	16,800	0,02	40 NTN
KJ20X25X18.8	20,000	25,000	18,800	0,04	40 NTN
KJ20X26X20.8	20,000	26,000	20,800	0,06	40 NTN

Reference	d	D	B	Kg	Brands
KJ20X26X23.8	20,000	26,000	23,800	0,02	40 NTN
KJ20X26X29.8	20,000	26,000	29,800	0,08	40 NTN
KJ22.2X27.2X23.6	22,200	27,200	23,600	0,06	40 NTN
KJ22X26X22.8	22,000	26,000	22,800	0,04	40 NTN
KJ22X28X17	22,000	28,000	16,800	0,06	40 NTN
KJ23X28X24.8	23,000	28,000	24,800	0,06	40 NTN
KJ25X30X18.8	25,000	30,000	18,800	0,05	40 NTN
KJ25X30X20	25,000	30,000	19,800	0,02	40 NTN
KJ25X30X23.8	25,000	30,000	23,800	0,07	40 NTN
KJ25X30X25	25,000	30,000	25,000	0,07	40 NTN
KJ25X32X31.3	25,000	32,000	31,300	0,12	40 NTN
KJ26X31X21.8	26,000	31,000	21,800	0,06	40 NTN
KJ26X31X25.8	26,000	31,000	25,800	0,07	40 NTN
KJ26X31X27.8	26,000	31,000	27,800	0,08	40 NTN
KJ27X31X16.8	27,000	31,000	16,800	0,04	40 NTN
KJ27X32X23.8	27,000	32,000	23,800	0,07	40 NTN
KJ28.1X32.1X23.8	28,100	32,100	23,800	0,06	40 NTN
KJ28X33X17	28,000	33,000	16,800	0,05	40 NTN
KJ28X33X19.8	28,000	33,000	19,800	0,06	40 NTN
KJ28X33X26.8	28,000	33,000	26,800	0,08	40 NTN
KJ28X33X29.8	28,000	33,000	29,800	0,03	40 NTN
KJ29X34X23.8	29,000	34,000	23,800	0,05	40 NTN
KJ29X34X27.8	29,000	34,000	27,800	0,03	40 NTN
KJ30X35X16.5	30,000	35,000	16,500	0,06	40 NTN
KJ30X35X17	30,000	35,000	16,800	0,06	40 NTN
KJ30X35X20	30,000	35,000	19,800	0,07	40 NTN
KJ30X35X21.8	30,000	35,000	21,800	0,03	40 NTN
KJ30X35X24.8	30,000	35,000	24,800	0,08	40 NTN
KJ30X35X25.8	30,000	35,000	25,800	0,09	40 NTN
KJ30X35X27	30,000	35,000	26,800	0,09	40 NTN
KJ30X35X29.8	30,000	35,000	29,800	0,07	40 NTN
KJ30X37X22.8	30,000	37,000	22,800	0,11	40 NTN
KJ30X37X27.3	30,000	37,000	27,300	0,13	40 NTN
KJ31X35X18.3	31,000	35,000	18,300	0,03	40 NTN
KJ31X36X18.3	31,000	36,000	18,300	0,04	40 NTN
KJ32X36X25.7	32,000	36,000	25,700	0,05	40 NTN
KJ32X37X17	32,000	37,000	16,800	0,02	40 NTN
KJ32X37X23.3	32,000	37,000	23,300	0,05	40 NTN
KJ32X37X24.7	23,000	37,000	24,700	0,03	40 NTN
KJ32X37X26.5	32,000	37,000	26,550	0,03	40 NTN
KJ32X37X27	32,000	37,000	26,800	0,10	40 NTN
KJ32X37X29.8	32,000	37,000	29,800	0,10	40 NTN
KJ32X38X20	32,000	38,000	19,800	0,08	40 NTN
KJ32X38X23.8	32,000	38,000	23,800	0,10	40 NTN
KJ32X38X28.1	32,000	38,000	28,100	0,04	40 NTN
KJ32X39X20	32,000	39,000	19,800	0,10	40 NTN
KJ32X40X18.8	32,000	40,000	18,800	0,04	40 NTN
KJ33X37X25.8	33,000	37,000	25,800	0,07	40 NTN
KJ33X38X14.8	33,000	38,000	14,800	0,05	40 NTN
KJ33X38X16.3	33,000	38,000	16,300	0,06	40 NTN
KJ33X38X27.3	33,000	38,000	27,300	0,10	40 NTN
KJ34X39X22.8	34,000	39,000	22,800	0,03	40 NTN

					Brands	
Reference	d	D	B	Kg		
KJ34X39X27.3	34,000	39,000	27,300	0,03	40	NTN
KJ34X40X17.8	34,000	40,000	17,800	0,09	40	NTN
KJ34X40X19.8	34,000	40,000	19,800	0,06	40	NTN
KJ34X40X23.8	34,000	40,000	23,800	0,04	40	NTN
KJ34X40X25.8	34,000	40,000	25,800	0,10	40	NTN
KJ35X39X23.8	35,000	39,000	23,800	0,07	40	NTN
KJ35X40X21.8	35,000	40,000	21,800	0,09	40	NTN
KJ35X40X22.8	35,000	40,000	22,800	0,08	40	NTN
KJ35X40X23.8	35,000	40,000	23,800	0,06	40	NTN
KJ35X40X24	35,000	40,000	24,000	0,09	40	NTN
KJ35X40X25.8	35,000	40,000	25,800	0,10	40	NTN
KJ35X40X27	35,000	40,000	26,800	0,10	40	NTN
KJ35X40X28.7	35,000	40,000	28,700	0,11	40	NTN
KJ35X40X31	35,000	40,000	31,000	0,12	40	NTN
KJ35X40X31.8	35,000	40,000	31,800	0,12	40	NTN
KJ35X40X34.8	35,000	40,000	34,800	0,12	40	NTN
KJ35X41X23.8	35,000	41,000	23,800	0,11	40	NTN
KJ35X41X25.8	35,000	41,000	25,800	0,04	40	NTN
KJ35X41X27.8	35,000	41,000	27,800	0,04	40	NTN
KJ35X41X28.8	35,000	41,000	28,800	0,13	40	NTN
KJ35X42X20	35,000	42,000	19,800	0,03	40	NTN
KJ35X42X30	35,000	42,000	29,800	0,05	40	NTN
KJ36X41X14.8	36,000	41,000	14,800	0,06	40	NTN
KJ36X41X18.3	36,000	41,000	18,300	0,05	40	NTN
KJ36X41X20.3	36,000	41,000	20,300	0,03	40	NTN
KJ36X41X25.3	36,000	41,000	25,300	0,10	40	NTN
KJ36X41X30.3	36,000	41,000	30,300	0,12	40	NTN
KJ37X42X14.8	37,000	42,000	14,800	0,02	40	NTN
KJ37X42X17	37,000	42,000	16,800	0,07	40	NTN
KJ37X42X23.1	37,000	42,000	23,100	0,07	40	NTN
KJ37X42X27	37,000	42,000	26,800	0,11	40	NTN
KJ37X42X29.8	37,000	42,000	29,800	0,04	40	NTN
KJ37X43X17.8	37,000	43,000	17,800	0,03	40	NTN
KJ37X43X22.8	37,000	43,000	22,800	0,11	40	NTN
KJ38X43X21.8	38,000	43,000	21,800	0,06	40	NTN
KJ38X43X25.8	38,000	43,000	25,800	0,10	40	NTN
KJ38X43X27.9	38,000	43,000	27,900	0,12	40	NTN
KJ38X43X29.8	38,000	43,000	29,800	0,12	40	NTN
KJ38X44X28.8	38,000	44,000	28,800	0,09	40	NTN
KJ39X44X18.3	39,000	44,000	18,300	0,06	40	NTN
KJ39X44X24.8	39,000	44,000	24,800	0,10	40	NTN
KJ40X45X22.3	40,000	45,000	22,300	0,11	40	NTN
KJ40X45X24.8	40,000	45,000	24,800	0,04	40	NTN
KJ40X45X26.8	40,000	45,000	26,800	0,04	40	NTN
KJ40X45X29.8	40,000	45,000	29,800	0,13	40	NTN
KJ40X47X28.8	40,000	47,000	28,800	0,17	40	NTN
KJ41X46X23.3	41,000	46,000	23,300	0,10	40	NTN
KJ41X46X28.6	41,000	46,000	28,600	0,08	40	NTN
KJ41X46X29.8	41,000	47,000	29,800	0,13	40	NTN
KJ42X47X21.8	42,000	47,000	21,800	0,10	40	NTN
KJ42X47X23.8	42,000	47,000	23,800	0,11	40	NTN
KJ42X47X27.3	42,000	47,000	27,300	0,04	40	NTN

					Brands	
Reference	d	D	B	Kg		
KJ42X47X29.8	42,000	47,000	29,800	0,05	40	NTN
KJ42X47X30.3	42,000	47,000	30,300	0,14	40	NTN
KJ42X47X35.3	42,000	47,000	35,300	0,16	40	NTN
KJ43X48X25.8	43,000	48,000	25,800	0,08	40	NTN
KJ43X48X29.8	43,000	48,000	29,800	0,14	40	NTN
KJ44X49X23.8	44,000	49,000	23,800	0,04	40	NTN
KJ44X50X27.8	44,000	50,000	27,800	0,16	40	NTN
KJ45X50X17	45,000	50,000	16,800	0,08	40	NTN
KJ45X50X29.6	45,000	50,000	29,600	0,14	40	NTN
KJ45X53X28	45,000	53,000	28,000	0,21	40	NTN
KJ48X53X20.8	48,000	53,000	20,800	0,11	40	NTN
KJ48X53X29.8	48,000	53,000	29,800	0,15	40	NTN
KJ48X54X23.8	48,000	54,000	23,800	0,10	40	NTN
KJ48X54X30.8	48,000	54,000	30,800	0,19	40	NTN
KJ51X57X22.8	51,000	57,000	22,800	0,15	40	NTN
KJ52X57X16.8	52,000	57,000	16,800	0,03	40	NTN
KJ53X59X18.3	53,000	59,000	18,300	0,09	40	NTN
KJ54.5X59.5X23.3	54,500	59,500	23,300	0,13	40	NTN
KJ54X60X25.8	54,000	60,000	25,800	0,19	40	NTN
KJ54X60X28.5	54,000	60,000	28,500	0,14	40	NTN
KJ55X60X20.8	55,000	60,000	20,800	0,12	40	NTN
KJ55X60X31.3	55,000	60,000	31,300	0,19	40	NTN
KJ55X60X34.8	55,000	60,000	34,800	0,20	40	NTN
KJ55X61X30	55,000	61,000	29,800	0,07	40	NTN
KJ55X61X33	55,000	61,000	33,000	0,26	40	NTN
KJ55X61X39.8	55,000	61,000	39,800	0,31	40	NTN
KJ56X61X17.8	56,000	61,000	17,800	0,10	40	NTN
KMJ10.1X15.5X19.8	10,170	15,570	19,800	0,01	40	NTN
KMJ10X14X11.3	10,000	14,000	11,300	0,01	40	NTN
KMJ10X14X8.8	10,000	14,000	8,800	0,01	40	NTN
KMJ10X14X9.3	10,000	14,000	9,300	0,003	40	NTN
KMJ10X14X9.8	10,000	14,000	9,800	0,01	40	NTN
KMJ11.3X16.1X26.3	11,300	16,100	26,300	0,04	40	NTN
KMJ12.8X17.6X26.3	12,800	17,600	26,300	0,03	40	NTN
KMJ12X16X11.3	12,000	16,000	11,300	0,01	40	NTN
KMJ12X17X11.8	12,000	17,000	11,800	0,01	40	NTN
KMJ12X17X9.8	12,000	17,000	9,800	0,02	40	NTN
KMJ13.8X18.8X16.3	13,850	18,850	16,300	0,03	40	NTN
KMJ14X18X11.8	14,000	18,000	11,800	0,02	40	NTN
KMJ14X19X11.8	14,000	19,000	11,800	0,02	40	NTN
KMJ15X20X15.8	15,000	20,000	15,800	0,03	40	NTN
KMJ15X21X16.8	15,000	21,000	16,800	0,01	40	NTN
KMJ15X21X17	15,000	21,000	16,800	0,04	40	NTN
KMJ16X22X11.8	16,000	22,000	11,800	0,04	40	NTN
KMJ16X22X13	16,000	22,000	12,800	0,03	40	NTN
KMJ16X22X16	16,000	22,000	15,800	0,02	40	NTN
KMJ16X23X13.8	16,000	23,000	13,800	0,01	40	NTN
KMJ17X22X12.6	17,000	22,000	12,600	0,03	40	NTN
KMJ17X22X14.1	17,000	22,000	14,100	0,03	40	NTN
KMJ17X24X14.5	17,000	24,000	14,500	0,01	40	NTN
KMJ18.6X25.6X16.3	18,600	25,600	16,300	0,02	40	NTN
KMJ18X24X12.6	18,000	24,000	12,600	0,04	40	NTN

Reference	d	D	B	Kg	?	Brands
KMJ18X24X14.1	18,000	24,000	14,100	0,03	40	NTN
KMJ18X24X17	18,000	24,000	16,800	0,04	40	NTN
KMJ19X25X19.2	19,000	25,000	19,200	0,05	40	NTN
KMJ19X25X22.2	19,000	25,000	22,200	0,04	40	NTN
KMJ20X26X11.8	20,000	26,000	11,800	0,04	40	NTN
KMJ20X26X13	20,000	26,000	12,800	0,04	40	NTN
KMJ20X26X13.8	20,000	26,000	13,800	0,04	40	NTN
KMJ20X26X15.1	20,000	26,000	15,100	0,04	40	NTN
KMJ20X26X17	20,000	26,000	16,800	0,05	40	NTN
KMJ20X26X20	20,000	26,000	19,800	0,06	40	NTN
KMJ20X28X16.8	20,000	28,000	16,800	0,07	40	NTN
KMJ20X28X18.5	20,000	28,000	18,500	0,07	40	NTN
KMJ20X28X19.8	20,000	28,000	19,800	0,08	40	NTN
KMJ21.3X29.5X17.3	21,300	29,500	17,300	0,02	40	NTN
KMJ21X25X12.8	21,000	25,000	12,800	0,02	40	NTN
KMJ22X30X17.3	22,000	30,000	17,300	0,07	40	NTN
KMJ22X30X23.8	22,000	30,000	23,800	0,10	40	NTN
KMJ23X27X12.8	23,000	27,000	12,800	0,03	40	NTN
KMJ23X29X17.8	23,000	29,000	17,800	0,06	40	NTN
KMJ24X30X24.1	24,000	30,000	24,100	0,08	40	NTN
KMJ25.1X30.1X13.8	25,100	30,100	13,800	0,04	40	NTN
KMJ25X30X21.8	25,000	30,000	21,800	0,06	40	NTN
KMJ25X31X18.3	25,000	31,000	18,300	0,04	40	NTN
KMJ25X33X24	25,000	33,000	23,800	0,12	40	NTN
KMJ26X33X13.8	26,000	33,000	13,800	0,06	40	NTN
KMJ28X34X16.8	28,000	34,000	16,800	0,07	40	NTN
KMJ28X35X13.8	28,000	35,000	13,800	0,07	40	NTN
KMJ30X36X14	30,000	36,000	13,800	0,06	40	NTN
KMJ30X37X20	30,000	37,000	19,800	0,10	40	NTN
KMJ32X38X14	32,000	38,000	13,800	0,06	40	NTN
KMJ36X42X14.8	36,000	42,000	14,800	0,02	40	NTN
KMJ38X46X20	38,000	46,000	19,800	0,14	40	NTN
KMJ40X46X14.3	40,000	46,000	14,300	0,07	40	NTN
KMJ40X48X18.8	40,000	48,000	18,800	0,05	40	NTN
KMJ46X52X14.8	46,000	52,000	14,800	0,06	40	NTN
KMJ75X81X20	75,000	81,000	19,800	0,20	40	NTN
KMJ85X92X18.8	85,000	92,000	18,800	0,23	40	NTN
KMJ85X92X20	85,000	92,000	19,800	0,25	40	NTN
KMJ85X93X35.8	85,000	93,000	35,800	0,50	40	NTN
KMJ90X97X19.8	90,000	97,000	19,800	0,26	40	NTN
KMJ95X102X19.8	95,000	102,000	19,800	0,23	40	NTN
KMJ95X102X20.8	95,000	102,000	20,800	0,29	40	NTN
KR0	3,000	10,000	17,000	0,01	44	NTN
KR0LL	3,000	10,000	17,000	0,01	44	NTN
KR0X	3,000	10,000	17,000	0,01	44	NTN
KR10	3,000	10,000	17,000	0,01	44	NTN
KR10LL	3,000	10,000	17,000	0,01	44	NTN
KR10X	3,000	10,000	17,000	0,02	44	NTN
KR10XLL	3,000	10,000	17,000	0,03	44	NTN
KR12	4,000	12,000	20,000	0,02	44	NTN
KR12LL	4,000	12,000	20,000	0,01	44	NTN
KR12X	4,000	12,000	20,000	0,01	44	NTN





Reference	d	D	B	Kg	?	Brands
KR12XLL	4,000	12,000	20,000	0,02	44	NTN
KR13	5,000	13,000	23,000	0,01	44	NTN
KR13LL	5,000	13,000	23,000	0,01	44	NTN
KR13X	5,000	13,000	23,000	0,01	44	NTN
KR13XLL	5,000	13,000	23,000	0,02	44	NTN
KR16	6,000	16,000	28,000	0,06	44	NTN
KR16LL	6,000	16,000	28,000	0,02	44	NTN
KR16X	8,000	16,000	28,000	0,06	44	NTN
KR16XLL	8,000	16,000	28,000	0,06	44	NTN
KR19	8,000	19,000	32,000	0,09	44	NTN
KR19LL	8,000	19,000	32,000	0,09	44	NTN
KR19X	10,000	19,000	32,000	0,09	44	NTN
KR19XLL	8,000	19,000	32,000	0,03	44	NTN
KR2	4,000	12,000	20,000	0,01	44	NTN
KR22	10,000	22,000	36,000	0,14	44	NTN
KR22C	10,000	22,000	36,000	0,14	44	NTN
KR22CLL	10,000	22,000	36,000	0,14	44	NTN
KR22LL	10,000	22,000	36,000	0,14	44	NTN
KR22X	10,000	22,000	36,000	0,14	44	NTN
KR22XCLL	10,000	22,000	36,000	0,14	44	NTN
KR22XLL	10,000	22,000	36,000	0,14	44	NTN
KR26	10,000	26,000	36,000	0,18	44	NTN
KR26C	10,000	26,000	36,000	0,12	44	NTN
KR26CLL	10,000	26,000	36,000	0,12	44	NTN
KR26LL	10,000	26,000	36,000	0,18	44	NTN
KR26X	10,000	26,000	36,000	0,18	44	NTN
KR26XCLL	10,000	26,000	36,000	0,12	44	NTN
KR26XLL	12,000	26,000	36,000	0,18	44	NTN
KR2CLL	10,000	22,000	36,000	0,14	44	NTN
KR2LL	4,000	12,000	20,000	0,02	44	NTN
KR2X	10,000	22,000	36,000	0,14	44	NTN
KR2XLL	4,000	12,000	20,000	0,01	44	NTN
KR3	5,000	13,000	23,000	0,03	44	NTN
KR30	15,000	30,000	40,000	0,26	44	NTN
KR30LL	12,000	30,000	40,000	0,09	44	NTN
KR30X	12,000	30,000	40,000	0,26	44	NTN
KR30XLL	12,000	30,000	40,000	0,17	44	NTN
KR32	15,000	32,000	40,000	0,29	44	NTN
KR32LL	15,000	32,000	40,000	0,29	44	NTN
KR32X	15,000	32,000	40,000	0,19	44	NTN
KR32XLL	12,000	32,000	40,000	0,10	44	NTN
KR35	15,000	35,000	52,000	0,51	44	NTN
KR35LL	15,000	35,000	52,000	0,51	44	NTN
KR35X	18,000	35,000	52,000	0,51	44	NTN
KR35XLL	16,000	35,000	52,000	0,34	44	NTN
KR3LL	5,000	13,000	23,000	0,03	44	NTN
KR3XLL	5,000	13,000	23,000	0,03	44	NTN
KR40	18,000	40,000	58,000	0,74	44	NTN
KR40LL	18,000	40,000	58,000	0,25	44	NTN
KR40X	18,000	40,000	58,000	0,74	44	NTN
KR40XLL	18,000	40,000	58,000	0,25	44	NTN
KR47	20,000	47,000	66,000	1,38	44	NTN





Reference	d	D	B	Kg	?	Brands
KR47LL	20,000	47,000	66,000	1,16	44	NTN
KR47X	20,000	47,000	66,000	1,38	44	NTN
KR47XLL	20,000	47,000	66,000	0,39	44	NTN
KR52	20,000	52,000	66,000	1,38	44	NTN
KR52LL	20,000	52,000	66,000	1,38	44	NTN
KR52X	20,000	52,000	66,000	1,38	44	NTN
KR52XLL	20,000	52,000	66,000	1,38	44	NTN
KR6	6,000	16,000	28,000	0,06	44	NTN
KR62	24,000	62,000	80,000	2,37	44	NTN
KR62LL	24,000	62,000	80,000	2,37	44	NTN
KR62X	24,000	62,000	80,000	1,58	44	NTN
KR62XLL	24,000	62,000	80,000	2,37	44	NTN
KR65	165,100	190,500	12,700	0,54	44	NTN
KR6CLL	10,000	26,000	36,000	0,12	44	NTN
KR6LL	6,000	16,000	28,000	0,06	44	NTN
KR6X	6,000	16,000	28,000	0,06	44	NTN
KR6XLL	6,000	16,000	28,000	0,06	44	NTN
KR72	24,000	72,000	80,000	3,12	44	NTN
KR72LL	30,000	72,000	80,000	3,12	44	NTN
KR72X	24,000	72,000	80,000	2,08	44	NTN
KR72XLL	24,000	72,000	80,000	1,04	44	NTN
KR80	30,000	80,000	100,000	4,65	44	NTN
KR80LL	38,000	80,000	100,000	4,65	44	NTN
KR80X	30,000	80,000	100,000	3,10	44	NTN
KR80XLL	30,000	80,000	100,000	4,65	44	NTN
KR85	38,000	85,000	100,000	3,48	44	NTN
KR85LL	38,000	85,000	100,000	3,48	44	NTN
KR85X	30,000	85,000	100,000	1,74	44	NTN
KR85XLL	30,000	85,000	100,000	1,74	44	NTN
KR9	8,000	19,000	32,000	0,10	44	NTN
KR90	38,000	90,000	100,000	3,90	44	NTN
KR90LL	38,000	90,000	100,000	3,90	44	NTN
KR90X	30,000	90,000	100,000	1,95	44	NTN
KR90XLL	30,000	90,000	100,000	1,95	44	NTN
KR9LL	8,000	19,000	32,000	0,09	44	NTN
KR9X	8,000	19,000	32,000	0,10	44	NTN
KR9XLL	8,000	19,000	32,000	0,10	44	NTN
KRT19LL	8,000	19,000	32,000	0,03	44	NTN
KRT30LL	12,000	30,000	40,000	0,09	44	NTN
KRT30XLL	12,000	30,000	40,000	0,17	44	NTN
KRT32	12,000	32,000	40,000	0,10	44	NTN
KRT32LL	12,000	32,000	40,000	0,10	44	NTN
KRT35	16,000	35,000	52,000	0,21	44	NTN
KRT35LL	16,000	35,000	52,000	0,21	44	NTN
KRT35XLL	16,000	35,000	52,000	0,21	44	NTN
KRT40	18,000	40,000	58,000	0,25	44	NTN
KRT40LL	18,000	40,000	58,000	0,25	44	NTN
KRT40XLL	18,000	40,000	58,000	0,25	44	NTN
KRT47LL	20,000	47,000	66,000	0,39	44	NTN
KRT47XLL	20,000	47,000	66,000	0,39	44	NTN
KRT52LL	20,000	52,000	66,000	1,38	44	NTN
KRT52XLL	20,000	52,000	66,000	1,38	44	NTN

Reference	d	D	B	Kg	?	Brands
KRT62LL	24,000	62,000	80,000	0,79	44	NTN
KRT62XLL	24,000	62,000	80,000	0,79	44	NTN
KRT72LL	24,000	72,000	80,000	1,04	44	NTN
KRT72XLL	24,000	72,000	80,000	1,04	44	NTN
KRT80LL	30,000	80,000	100,000	3,10	44	NTN
KRT90LL	30,000	90,000	100,000	3,90	44	NTN
KRU16LL	6,000	16,000	28,000	0,04	44	NTN
KRU16XLL	6,000	16,000	28,000	0,02	44	NTN
KRU19	8,000	19,000	32,000	0,03	44	NTN
KRU19LL	8,000	19,000	32,000	0,06	44	NTN
KRU22LL	10,000	22,000	36,000	0,14	44	NTN
KRU26LL	10,000	26,000	36,000	0,18	44	NTN
KRU30LL	12,000	30,000	40,000	0,26	44	NTN
KRU30XLL	12,000	30,000	40,000	0,26	44	NTN
KRU32XLL	12,000	32,000	40,000	0,29	44	NTN
KRU35	16,000	35,000	50,000	0,17	44	NTN
KRU35LL	16,000	35,000	52,000	0,51	44	NTN
KRU35XLL	16,000	35,000	52,000	0,34	44	NTN
KRU40LL	18,000	40,000	58,000	0,74	44	NTN
KRU47LL	20,000	47,000	66,000	0,39	44	NTN
KRU47XLL	20,000	47,000	66,000	0,77	44	NTN
KRU52	20,000	52,000	66,000	0,92	44	NTN
KRU52LL	20,000	52,000	66,000	1,38	44	NTN
KRU52XLL	20,000	52,000	66,000	1,38	44	NTN
KRU62LL	24,000	62,000	80,000	1,58	44	NTN
KRU62XLL	24,000	62,000	80,000	0,79	44	NTN
KRU80	30,000	80,000	100,000	1,55	44	NTN
KRU80LL	30,000	80,000	100,000	3,10	44	NTN
KRU80XLL	30,000	80,000	100,000	1,55	44	NTN
KRU90LL	30,000	90,000	100,000	1,95	44	NTN
KRU90XLL	30,000	90,000	100,000	1,95	44	NTN
KRV30	12,000	30,000	40,000	0,27	44	NTN
KRV30LL	15,000	30,000	40,000	0,27	44	NTN
KRV30X	12,000	30,000	40,000	0,27	44	NTN
KRV30XLL	12,000	30,000	40,000	0,09	44	NTN
KRV32	15,000	32,000	40,000	0,30	44	NTN
KRV32LL	15,000	32,000	40,000	0,30	44	NTN
KRV32X	15,000	32,000	40,000	0,30	44	NTN
KRV32XLL	15,000	32,000	40,000	0,20	44	NTN
KRV35	18,000	35,000	52,000	0,34	44	NTN
KRV35LL	18,000	35,000	52,000	0,52	44	NTN
KRV35X	18,000	35,000	52,000	0,40	44	NTN
KRV35XLL	18,000	35,000	52,000	0,40	44	NTN
KRV40	18,000	40,000	58,000	0,76	44	NTN
KRV40LL	18,000	40,000	58,000	0,76	44	NTN
KRV40X	22,000	40,000	58,000	0,50	44	NTN
KRV40XLL	18,000	40,000	58,000	0,89	44	NTN
KRV47	25,000	47,000	66,000	1,17	44	NTN
KRV47LL	20,000	47,000	66,000	0,39	44	NTN
KRV47X	25,000	47,000	66,000	0,78	44	NTN
KRV47XLL	25,000	47,000	66,000	1,17	44	NTN
KRV52	25,000	52,000	66,000	0,05	44	NTN

Reference	d	D	B	Kg	?	Brands
KRV52LL	25,000	52,000	66,000	1,40	44	NTN
KRV52X	25,000	52,000	66,000	1,40	44	NTN
KRV52XLL	20,000	52,000	66,000	1,40	44	NTN
KRV62	30,000	62,000	80,000	1,60	44	NTN
KRV62LL	30,000	62,000	80,000	2,40	44	NTN
KRV62X	30,000	62,000	80,000	1,60	44	NTN
KRV62XLL	30,000	62,000	80,000	2,40	44	NTN
KRV6LL	10,000	26,000	36,000	0,18	44	NTN
KRV72	30,000	72,000	80,000	2,09	44	NTN
KRV72LL	30,000	72,000	80,000	3,14	44	NTN
KRV72X	30,000	72,000	80,000	1,05	44	NTN
KRV72XLL	24,000	72,000	80,000	3,15	44	NTN
KRV80	38,000	80,000	100,000	4,65	44	NTN
KRV80LL	38,000	80,000	100,000	4,68	44	NTN
KRV80X	38,000	80,000	100,000	3,12	44	NTN
KRV80XLL	30,000	80,000	100,000	4,68	44	NTN
KRV90	38,000	90,000	100,000	2,32	44	NTN
KRV90LL	38,000	90,000	100,000	2,32	44	NTN
KRV90X	38,000	90,000	100,000	1,97	44	NTN
KRV90XLL	30,000	90,000	100,000	5,91	44	NTN
KRV19LL	8,000	19,000	32,000	0,10	44	NTN
KRV30LL	12,000	30,000	40,000	0,33	44	NTN
KRV30XLL	12,000	30,000	40,000	0,33	44	NTN
KRV32XLL	12,000	32,000	40,000	0,45	44	NTN
KRV35LL	16,000	35,000	52,000	0,52	44	NTN
KRV35X	16,000	35,000	52,000	0,17	44	NTN
KRV35XLL	16,000	35,000	52,000	0,52	44	NTN
KRV40LL	22,000	40,000	58,000	0,87	44	NTN
KRV40XLL	22,000	40,000	58,000	0,59	44	NTN
KRV47	20,000	47,000	66,000	1,17	44	NTN
KRV47LL	20,000	47,000	66,000	1,17	44	NTN
KRV47XLL	20,000	47,000	66,000	1,17	44	NTN
KRV52LL	20,000	52,000	66,000	1,40	44	NTN
KRV52XLL	20,000	52,000	66,000	0,93	44	NTN
KRV62LL	24,000	62,000	80,000	2,40	44	NTN
KRV62XLL	24,000	62,000	80,000	2,40	44	NTN
KRV72LL	24,000	72,000	80,000	1,05	44	NTN
KRV72XLL	24,000	72,000	80,000	1,05	44	NTN
KRV80LL	30,000	80,000	100,000	3,12	44	NTN
KRV80XLL	30,000	80,000	100,000	3,12	44	NTN
KRVU22LL	10,000	22,000	36,000	0,06	44	NTN
KRVU26LL	10,000	26,000	36,000	0,09	44	NTN
KRVU30LL	12,000	30,000	40,000	0,11	44	NTN
KRVU30XLL	12,000	30,000	40,000	0,09	44	NTN
KRVU35LL	16,000	35,000	52,000	0,17	44	NTN
KRVU35XLL	16,000	35,000	52,000	0,17	44	NTN
KRVU40XLL	18,000	40,000	58,000	0,50	44	NTN
KRVU47LL	20,000	47,000	66,000	1,17	44	NTN
KRVU47XLL	20,000	47,000	66,000	1,17	44	NTN
KRVU52	20,000	52,000	66,000	0,54	44	NTN
KRVU52XLL	20,000	52,000	66,000	0,54	44	NTN
KRVU72XLL	20,000	72,000	80,000	1,00	44	NTN

Reference	d	D	B	Kg	?	Brands
KRVU80LL	30,000	80,000	100,000	1,56	44	NTN
KRVU80XLL	30,000	80,000	100,000	1,56	44	NTN
KV12X17X17.8	12,000	17,000	17,800	0,03	40	NTN
KV14.3X19X8.8	14,300	19,040	8,800	0,01	40	NTN
KV14X17X10	14,000	17,000	9,800	0,01	40	NTN
KV15.9X20.6X8.8	15,900	20,640	8,800	0,01	40	NTN
KV15X19X7.8	15,000	19,000	7,800	0,01	40	NTN
KV19X23X17	19,000	23,000	16,800	0,01	40	NTN
KV20X26X18.2	20,000	26,000	18,200	0,04	40	NTN
KV22X26X13	22,000	26,000	12,800	0,01	40	NTN
KV22X26X33.8ZW	22,000	26,000	33,800	0,06	40	NTN
KV22X27X21.3	22,000	27,000	21,300	0,04	40	NTN
KV22X28X19.5	22,000	28,000	19,500	0,07	40	NTN
KV25X32X31.3	25,000	32,000	31,300	0,92	40	NTN
KV30X34X13.8	30,000	34,000	13,800	0,04	40	NTN
KV30X35X13	30,000	35,000	12,800	0,05	40	NTN
KV30X35X17	30,000	35,000	16,800	0,02	40	NTN
KV30X40X37.8	30,000	40,000	37,800	0,29	40	NTN
KV31X35X23.8	31,000	35,000	23,800	0,07	40	NTN
KV31X36X13.8	31,000	36,000	13,800	0,05	40	NTN
KV32X37X23.8	32,000	37,000	23,800	0,03	40	NTN
KV32X40X49.2ZW	32,000	40,000	49,200	0,30	40	NTN
KV34X40X39.3ZW	34,000	40,000	39,300	0,20	40	NTN
KV35X39X22.3	35,000	39,000	22,300	0,07	40	NTN
KV35X40X39.8ZW	35,000	40,000	39,800	0,15	40	NTN
KV35X42X20	35,000	42,000	19,800	0,04	40	NTN
KV37X43X33.3	37,000	43,000	33,300	0,19	40	NTN
KV38X43X24.8	38,000	43,000	24,800	0,11	40	NTN
KV38X44X19.8	38,000	44,000	19,800	0,07	40	NTN
KV38X44X22.3	38,000	44,000	22,300	0,09	40	NTN
KV39X44X30.8	39,000	44,000	30,800	0,10	40	NTN
KV40.5X45.5X22.3	40,500	45,500	22,300	0,07	40	NTN
KV40X44X22.8	40,000	44,000	22,800	0,17	40	NTN
KV40X46X33.8	40,000	46,000	33,800	0,19	40	NTN
KV40X48X25	40,000	48,000	24,800	0,20	40	NTN
KV42X47X23.3	42,000	47,000	23,300	0,12	40	NTN
KV42X47X27	42,000	47,000	27,000	0,09	40	NTN
KV42X47X35.3ZW	42,000	47,000	35,300	0,05	40	NTN
KV42X50X39.6ZW	42,000	50,000	39,600	0,32	40	NTN
KV43X48X22.3	43,000	48,000	22,300	0,04	40	NTN
KV43X48X37.8ZW	43,000	48,000	37,800	0,17	40	NTN
KV43X50X51.3ZW	43,000	50,000	51,300	0,11	40	NTN
KV44.5X48.5X21.3	44,500	48,500	21,300	0,09	40	NTN
KV44.5X48.5X25.8ZW	44,500	48,500	25,800	0,10	40	NTN
KV44X50X30.8	44,000	50,000	30,800	0,20	40	NTN
KV44X50X36.3	44,000	50,000	36,300	0,22	40	NTN
KV45X50X25.8	45,000	50,000	25,800	0,14	40	NTN
KV45X51X24.3	45,000	51,000	24,300	0,16	40	NTN
KV45X51X26.8	45,000	51,000	26,800	0,17	40	NTN
KV47X52X15.3	47,000	52,000	15,300	0,03	40	NTN
KV47X52X22.8	47,000	52,000	22,800	0,13	40	NTN
KV47X52X32.8ZW	47,000	52,000	32,800	0,19	40	NTN

					Brands	
Reference	d	D	B	Kg		
KV48X53X22.3	48,000	53,000	22,300	0,13	40	NTN
KV48X53X36.8ZW	48,000	53,000	36,800	0,19	40	NTN
KV48X54X23.3	48,000	54,000	23,300	0,17	40	NTN
KV48X54X26.3	48,000	54,000	26,300	0,06	40	NTN
KV48X55X24.3	48,000	55,000	24,300	0,21	40	NTN
KV49X54X32.8ZW	49,000	54,000	32,800	0,18	40	NTN
KV50X55X20	50,000	55,000	19,800	0,12	40	NTN
KV50X58X25	50,000	58,000	24,800	0,08	40	NTN
KV50X58X57.8ZW	50,000	58,000	57,800	0,56	40	NTN
KV52X57X17.8	52,000	57,000	17,800	0,11	40	NTN
KV52X57X22.8	52,000	57,000	22,800	0,14	40	NTN
KV53X57X19.8	53,000	57,000	19,800	0,06	40	NTN
KV53X59X21.3	53,000	59,000	21,300	0,16	40	NTN
KV54.5X60.5X24.3	54,500	60,500	24,300	0,20	40	NTN
KV54.5X61.5X32.8	54,500	61,500	32,800	0,30	40	NTN
KV54X59X22.8	54,000	59,000	22,800	0,15	40	NTN
KV55X60X30	55,000	60,000	29,800	0,20	40	NTN
KV56X62X16	56,000	62,000	16,000	0,05	40	NTN
KV57.5X65.5X30.8	57,500	65,500	30,800	0,36	40	NTN
KV57.5X65.5X36.3	57,500	65,500	36,300	0,14	40	NTN
KV57X65X39.8ZW	57,000	65,000	39,800	0,44	40	NTN
KV61X66X31.8ZW	61,000	66,000	31,800	0,07	40	NTN
KV63X71X44.2ZW	63,000	71,000	44,200	0,35	40	NTN
KV63X71X50.3ZW	63,000	71,000	50,300	0,58	40	NTN
KV64X72X44.6ZW	64,000	72,000	44,600	0,53	40	NTN
KV65X70X21.3	65,000	70,000	21,300	0,17	40	NTN
KV65X73X29.6	65,000	73,000	29,600	0,39	40	NTN
KV68X73X31.4ZW	68,000	73,000	31,400	0,25	40	NTN
KV7.9X11.9X7.8	7,940	11,940	7,800	0,01	40	NTN
KV72X80X19.3	72,000	80,000	19,300	0,10	40	NTN
KV72X80X35.8	72,000	80,000	35,800	0,03	40	NTN
KV72X80X39.8ZW	72,000	80,000	39,800	0,55	40	NTN
KV75X81X19.8	75,000	81,000	19,800	0,21	40	NTN
KV75X83X32.6ZW	75,000	83,000	32,600	0,48	40	NTN
KV78X86X47.8ZW	78,000	86,000	47,800	0,48	40	NTN
KV7X10X12.8	7,000	10,000	12,800	0,002	40	NTN
KV80X86X20	80,000	86,000	19,800	0,23	40	NTN
KV85X92X22.6	85,000	92,000	22,600	0,23	40	NTN
KV85X93X20.3	85,000	93,000	20,300	0,12	40	NTN
KV89X97X67.ZW	89,000	97,000	67,800	1,17	40	NTN
KV8X11X10	8,000	11,000	9,800	0,002	40	NTN
KV8X11X8	8,000	11,000	7,800	0,005	40	NTN
KV97X104X21.3	97,000	104,000	21,300	0,13	40	NTN
KV9X12X10	9,000	12,000	9,800	0,01	40	NTN
M1-060908	9,525	14,288	12,950	0,01	55	NTN
M1-061012	9,525	15,875	19,300	0,02	55	NTN
M1-061016	9,525	15,875	25,650	0,05	55	NTN
M1-081210	12,700	19,050	16,130	0,02	55	NTN
M1-081212	12,700	19,050	19,300	0,05	55	NTN
M1-081216	12,700	19,050	25,650	0,06	55	NTN
M1-101408	15,875	22,225	12,950	0,02	55	NTN
M1-101412	15,875	22,225	19,300	0,06	55	NTN

					Brands	
Reference	d	D	B	Kg		
M1-101416	15,875	22,225	25,650	0,04	55	NTN
M1-102416	31,750	38,100	25,650	0,14	55	NTN
M1-102420	31,750	38,100	32,000	0,25	55	NTN
M1-104824	63,500	76,200	38,350	0,81	55	NTN
M1-104828	63,500	76,200	44,700	0,95	55	NTN
M1-106032	79,375	95,250	51,050	1,70	55	NTN
M1-109640	12,700	152,400	63,880	9,03	55	NTN
M1-112616	33,338	41,275	25,650	0,09	55	NTN
M1-112620	33,338	41,275	32,000	0,12	55	NTN
M1-121612	19,050	25,400	19,300	0,07	55	NTN
M1-121616	19,050	25,400	25,650	0,13	55	NTN
M1-122816	34,925	44,450	25,650	0,12	55	NTN
M1-122820	34,925	44,450	32,000	0,29	55	NTN
M1-124024	50,800	63,500	38,350	0,67	55	NTN
M1-124028	50,800	63,500	44,700	0,79	55	NTN
M1-126032	82,550	95,250	51,050	0,71	55	NTN
M1-141816	22,225	28,575	25,650	0,05	55	NTN
M1-141820	22,225	28,575	32,000	0,06	55	NTN
M1-142816	38,100	44,450	25,650	0,16	55	NTN
M1-145228	69,850	82,550	44,700	1,04	55	NTN
M1-153020	39,688	47,625	32,000	0,14	55	NTN
M1-162012	25,400	31,750	19,300	0,08	55	NTN
M1-162016	25,400	31,750	25,650	0,11	55	NTN
M1-162020	25,400	31,750	32,000	0,14	55	NTN
M1-163216	41,275	50,800	25,650	0,13	55	NTN
M1-163220	41,275	50,800	32,000	0,17	55	NTN
M1-164424	57,150	69,850	38,350	0,76	55	NTN
M1-164428	57,150	69,850	44,700	0,44	55	NTN
M1-182216	28,575	34,925	25,650	0,06	55	NTN
M1-182220	28,575	34,925	32,000	0,16	55	NTN
M1-183628	44,450	57,150	44,700	0,35	55	NTN
M1-185632	76,200	88,900	51,050	1,93	55	NTN
M1-648036	101,600	127,000	57,400	4,14	55	NTN
MR101812	15,875	28,575	19,050	0,14	41	NTN
MR101816	15,875	28,575	25,400	0,19	41	NTN
MR11614648	184,150	231,775	76,200	7,41	41	NTN
MR122012	19,050	31,750	19,050	0,16	41	NTN
MR122016	19,050	31,750	25,400	0,14	41	NTN
MR142212	22,225	34,925	19,050	0,18	41	NTN
MR142216	22,225	34,925	25,400	0,08	41	NTN
MR162412	25,400	38,100	19,050	0,20	41	NTN
MR162416	25,400	38,100	25,400	0,18	41	NTN
MR182616	28,575	41,275	25,400	0,02	41	NTN
MR182620	28,575	41,275	31,750	0,36	41	NTN
MR202816	31,750	44,450	25,400	0,32	41	NTN
MR202820	31,750	44,450	31,750	0,14	41	NTN
MR223016	34,925	47,625	25,400	0,11	41	NTN
MR223020	34,925	47,625	31,750	0,43	41	NTN
MR243316	38,100	52,388	25,400	0,42	41	NTN
MR243320	38,100	52,388	31,750	0,53	41	NTN
MR263516	41,275	55,562	25,400	0,30	41	NTN
MR263520	41,275	55,562	31,750	0,39	41	NTN

Reference	d	D	B	Kg	Brands
MR283716	44,450	58,738	25,400	0,48	41 NTN
MR283720	44,450	58,738	31,750	0,41	41 NTN
MR303920	47,625	61,912	31,750	0,22	41 NTN
MR324120	50,800	65,088	31,750	0,69	41 NTN
MR364824	57,150	76,200	38,100	1,26	41 NTN
MR364828	57,150	76,200	44,450	1,48	41 NTN
MR405224	63,500	82,550	38,100	0,94	41 NTN
MR405228	63,500	82,550	44,450	1,59	41 NTN
MR445624	69,850	88,900	38,100	0,98	41 NTN
MR445628	69,850	88,900	44,450	1,73	41 NTN
MR486024	76,200	95,250	38,100	1,61	41 NTN
MR486028	76,200	95,250	44,450	1,89	41 NTN
MR526828	82,550	107,950	44,450	1,85	41 NTN
MR526832	82,550	107,950	50,800	2,12	41 NTN
MR567232	88,900	114,300	50,800	2,26	41 NTN
MR607632	95,250	120,650	50,800	3,62	41 NTN
MR648032	101,600	127,000	50,800	2,57	41 NTN
MR688432	107,950	133,350	50,800	1,36	41 NTN
MR729636	114,300	152,400	57,150	2,62	41 NTN
MR8010436	127,000	165,100	57,150	2,89	41 NTN
MR8811248	139,700	177,800	76,200	4,20	41 NTN
NA0-12X28X12	12,000	28,000	12,000	0,08	42 NTN
NA0-20X35X17	20,000	35,000	17,000	0,08	42 NTN
NA0-20X45X26ZW	30,000	45,000	26,000	0,16	42 NTN
NA0-240X360X114.3	240,000	360,000	114,300	44,90	42 NTN
NA0-25X40X17	25,000	40,000	17,000	0,09	42 NTN
NA0-25X50X17	35,000	50,000	17,000	0,12	42 NTN
NA0-25X55X20	35,000	55,000	20,000	0,39	42 NTN
NA0-40X62X40ZW	40,000	62,000	40,000	0,46	42 NTN
NA0-45X65X20	45,000	65,000	20,000	0,29	42 NTN
NA0-50X68X20	50,000	68,000	20,000	0,23	42 NTN
NA0-80X110X152	80,000	110,000	152,000	4,71	42 NTN
NA22/6LL	6,000	19,000	12,000	0,07	43 NTN
NA22/6XLL	6,000	19,000	12,000	0,07	43 NTN
NA22/8LL	8,000	24,000	12,000	0,10	43 NTN
NA22/8XLL	8,000	24,000	12,000	0,10	43 NTN
NA2200LL	10,000	30,000	14,000	0,18	43 NTN
NA2200XLL	10,000	30,000	14,000	0,12	43 NTN
NA2201LL	12,000	32,000	14,000	0,13	43 NTN
NA2201XLL	12,000	32,000	14,000	0,13	43 NTN
NA2202LL	15,000	35,000	14,000	0,23	43 NTN
NA2203LL	17,000	40,000	16,000	0,34	43 NTN
NA2203XLL	17,000	40,000	16,000	0,34	43 NTN
NA2204LL	20,000	47,000	18,000	0,54	43 NTN
NA2204XLL	20,000	47,000	18,000	0,36	43 NTN
NA2205LL	25,000	52,000	18,000	0,62	43 NTN
NA2205XLL	25,000	52,000	18,000	0,21	43 NTN
NA2206LL	30,000	62,000	20,000	1,00	43 NTN
NA2206XLL	30,000	62,000	20,000	0,64	43 NTN
NA2207LL	35,000	72,000	23,000	1,01	43 NTN
NA2207XLL	35,000	72,000	23,000	0,51	43 NTN
NA2208LL	40,000	80,000	23,000	1,86	43 NTN





Reference	d	D	B	Kg	Brands
NA2210LL	50,000	90,000	23,000	0,68	43 NTN
NA4822	110,000	140,000	30,000	3,27	42 NTN
NA4824	120,000	150,000	30,000	3,54	42 NTN
NA4826	130,000	165,000	35,000	3,61	42 NTN
NA4828	140,000	175,000	35,000	1,93	42 NTN
NA4830	150,000	190,000	40,000	5,50	42 NTN
NA4832	160,000	200,000	40,000	2,89	42 NTN
NA4834	170,000	215,000	45,000	3,99	42 NTN
NA4836	180,000	225,000	45,000	4,26	42 NTN
NA4838	190,000	240,000	50,000	16,86	42 NTN
NA4840	200,000	250,000	50,000	17,52	42 NTN
NA4844	220,000	270,000	50,000	6,37	42 NTN
NA4848	240,000	300,000	60,000	30,00	42 NTN
NA4852	260,000	320,000	60,000	32,40	42 NTN
NA4856	280,000	350,000	69,000	31,00	42 NTN
NA4860	300,000	380,000	80,000	44,00	42 NTN
NA4864	320,000	400,000	80,000	46,40	42 NTN
NA4872	360,000	440,000	80,000	25,70	42 NTN
NA4876	380,000	480,000	100,000	44,50	42 NTN
NA49/22R	22,000	39,000	17,000	0,24	42 NTN
NA49/28R	28,000	45,000	17,000	0,20	42 NTN
NA49/32R	32,000	52,000	20,000	0,47	42 NTN
NA4900LL	10,000	22,000	14,000	0,07	42 NTN
NA4900R	10,000	22,000	14,000	0,07	42 NTN
NA4901LL	12,000	24,000	14,000	0,08	42 NTN
NA4901R	12,000	24,000	13,000	0,08	42 NTN
NA4902LL	15,000	28,000	14,000	0,08	42 NTN
NA4902R	15,000	28,000	13,000	0,10	42 NTN
NA4903LL	17,000	30,000	13,000	0,12	42 NTN
NA4903R	17,000	30,000	13,000	0,12	42 NTN
NA4904LL	20,000	37,000	17,000	0,26	42 NTN
NA4904R	20,000	37,000	17,000	0,27	42 NTN
NA4905LL	25,000	42,000	18,000	0,30	42 NTN
NA4905R	25,000	42,000	17,000	0,27	42 NTN
NA4906LL	30,000	47,000	17,000	0,35	42 NTN
NA4906R	30,000	47,000	17,000	0,31	42 NTN
NA4907LL	35,000	55,000	21,000	0,38	42 NTN
NA4907R	35,000	55,000	20,000	0,52	42 NTN
NA4908LL	40,000	62,000	23,000	0,80	42 NTN
NA4908R	40,000	62,000	22,000	0,70	42 NTN
NA4909LL	45,000	68,000	23,000	0,94	42 NTN
NA4909R	45,000	68,000	22,000	0,82	42 NTN
NA4910LL	50,000	72,000	22,000	0,96	42 NTN
NA4910R	50,000	72,000	22,000	0,84	42 NTN
NA4911R	55,000	80,000	25,000	0,40	42 NTN
NA4912R	60,000	85,000	25,000	1,28	42 NTN
NA4913R	65,000	90,000	25,000	1,37	42 NTN
NA4914R	70,000	100,000	30,000	1,57	42 NTN
NA4915R	75,000	105,000	30,000	2,28	42 NTN
NA4916R	80,000	110,000	30,000	2,47	42 NTN
NA4917R	85,000	120,000	35,000	3,76	42 NTN
NA4918R	90,000	125,000	35,000	3,92	42 NTN





Reference	d	D	B	Kg	?	Brands
NA4919R	95,000	130,000	35,000	4,10	42	NTN
NA4920	100,000	140,000	40,000	3,86	42	NTN
NA4922	110,000	150,000	40,000	6,21	42	NTN
NA4924	120,000	165,000	45,000	2,88	42	NTN
NA4926	130,000	180,000	50,000	11,75	42	NTN
NA4928	140,000	190,000	50,000	12,47	42	NTN
NA4930	150,000	210,000	60,000	10,66	42	NTN
NA4936	180,000	250,000	69,000	25,74	42	NTN
NA4940	200,000	280,000	80,000	12,20	42	NTN
NA498	8,000	19,000	11,000	0,05	42	NTN
NA59/22	22,000	39,000	23,000	0,27	42	NTN
NA59/32	32,000	52,000	27,000	0,43	42	NTN
NA5903	17,000	30,000	18,000	0,16	42	NTN
NA5904	20,000	37,000	23,000	0,31	42	NTN
NA5905	25,000	42,000	23,000	0,36	42	NTN
NA5906	30,000	47,000	23,000	0,42	42	NTN
NA5907	35,000	55,000	27,000	0,70	42	NTN
NA5908	40,000	62,000	30,000	1,02	42	NTN
NA5909	45,000	68,000	30,000	1,16	42	NTN
NA5910	50,000	72,000	30,000	0,39	42	NTN
NA5911	55,000	80,000	34,000	1,71	42	NTN
NA5912	60,000	85,000	34,000	1,85	42	NTN
NA5913	65,000	90,000	34,000	1,97	42	NTN
NA5914	70,000	100,000	40,000	3,00	42	NTN
NA5915	75,000	105,000	40,000	2,02	42	NTN
NA5916	80,000	110,000	40,000	3,36	42	NTN
NA5917	85,000	120,000	46,000	3,52	42	NTN
NA5919	95,000	180,000	46,000	1,98	42	NTN
NA5924	120,000	165,000	10,000	3,92	42	NTN
NA5926	130,000	180,000	67,000	5,60	42	NTN
NA5928	140,000	190,000	67,000	18,54	42	NTN
NA69/22R	22,000	39,000	30,000	0,45	42	NTN
NA69/28R	28,000	45,000	30,000	0,53	42	NTN
NA69/32R	32,000	52,000	36,000	0,88	42	NTN
NA6901R	12,000	24,000	22,000	0,14	42	NTN
NA6902R	15,000	28,000	23,000	0,19	42	NTN
NA6903R	17,000	30,000	23,000	0,20	42	NTN
NA6904R	20,000	37,000	30,000	0,40	42	NTN
NA6905R	25,000	42,000	30,000	0,48	42	NTN
NA6906R	30,000	47,000	30,000	0,55	42	NTN
NA6907R	35,000	55,000	36,000	0,94	42	NTN
NA6908R	40,000	62,000	40,000	1,27	42	NTN
NA6909R	45,000	68,000	40,000	1,52	42	NTN
NA6910R	50,000	72,000	40,000	1,54	42	NTN
NA6911R	55,000	80,000	45,000	2,20	42	NTN
NA6912R	60,000	85,000	45,000	2,36	42	NTN
NA6913R	65,000	90,000	45,000	0,85	42	NTN
NA6914R	70,000	100,000	54,000	3,93	42	NTN
NA6915R	75,000	105,000	54,000	4,17	42	NTN
NA6916R	80,000	110,000	54,000	2,97	42	NTN
NA6917R	85,000	120,000	63,000	6,76	42	NTN
NA6918R	90,000	125,000	63,000	7,11	42	NTN

Reference	d	D	B	Kg	?	Brands
NA6919R	95,000	130,000	63,000	7,41	42	NTN
NACV46XLL	25,400	76,200	46,038	2,90	46	NTN
NACV64XLL	31,750	101,600	58,738	3,49	46	NTN
NACV80XLL	44,450	127,000	73,025	12,16	46	NTN
NACV96XLL	57,150	152,400	85,725	9,80	46	NTN
NATR10	10,000	30,000	15,000	0,19	45	NTN
NATR10LL	10,000	30,000	15,000	0,19	45-A	NTN
NATR10X	10,000	30,000	15,000	0,19	45	NTN
NATR10XLL	10,000	30,000	15,000	0,06	45-A	NTN
NATR12	12,000	32,000	15,000	0,21	45	NTN
NATR12LL	12,000	32,000	15,000	0,20	45-A	NTN
NATR12X	12,000	32,000	15,000	0,22	45	NTN
NATR12X40X24	12,000	40,000	24,000	0,19	45	NTN
NATR12XLL	12,000	32,000	15,000	0,21	45-A	NTN
NATR15	15,000	35,000	19,000	0,32	45	NTN
NATR15LL	15,000	35,000	19,000	0,30	45-A	NTN
NATR15X	15,000	35,000	19,000	0,32	45	NTN
NATR15XLL	15,000	35,000	19,000	0,10	45-A	NTN
NATR17	17,000	40,000	21,000	0,46	45	NTN
NATR17LL	17,000	40,000	21,000	0,29	45-A	NTN
NATR17X	17,000	40,000	21,000	0,31	45	NTN
NATR17XLL	17,000	40,000	21,000	0,29	45-A	NTN
NATR20	20,000	47,000	25,000	0,75	45	NTN
NATR20LL	20,000	47,000	25,000	0,48	45-A	NTN
NATR20X	20,000	47,000	25,000	0,75	45	NTN
NATR20X45X25	20,000	45,000	25,000	0,44	45	NTN
NATR20X47X25	20,000	47,000	25,000	0,24	45	NTN
NATR20XLL	20,000	47,000	25,000	0,48	45-A	NTN
NATR25	25,000	52,000	25,000	0,86	45	NTN
NATR25LL	25,000	52,000	25,000	0,28	45-A	NTN
NATR25X	25,000	52,000	25,000	0,57	45	NTN
NATR25XLL	25,000	52,000	25,000	0,83	45-A	NTN
NATR30	30,000	62,000	29,000	1,41	45	NTN
NATR30LL	30,000	62,000	29,000	1,38	45-A	NTN
NATR30X	30,000	62,000	29,000	1,41	45	NTN
NATR30X62X29	30,000	62,000	29,000	0,46	45	NTN
NATR30XLL	30,000	62,000	29,000	1,38	45-A	NTN
NATR31.7X76.2X32	31,700	76,200	32,000	2,51	45	NTN
NATR35	35,000	72,000	29,000	1,28	45	NTN
NATR35LL	35,000	72,000	29,000	1,88	45-A	NTN
NATR35X	35,000	72,000	29,000	0,64	45	NTN
NATR35XLL	35,000	72,000	29,000	1,88	45-A	NTN
NATR40	40,000	80,000	32,000	2,56	45	NTN
NATR40LL	40,000	80,000	32,000	2,50	45-A	NTN
NATR40X	40,000	80,000	32,000	1,70	45	NTN
NATR40X80X32	40,000	80,000	32,000	0,85	45	NTN
NATR40XLL	40,000	80,000	32,000	2,50	45-A	NTN
NATR45	45,000	85,000	32,000	0,92	45	NTN
NATR45LL	45,000	85,000	32,000	1,81	45-A	NTN
NATR45X130X40	45,000	130,000	40,000	10,14	45	NTN
NATR45XLL	45,000	85,000	32,000	0,91	45-A	NTN
NATR5	5,000	16,000	12,000	0,04	45	NTN

Reference	d	D	B	Kg	Brands
NATR50	50,000	90,000	32,000	2,97	45 NTN
NATR50LL	50,000	90,000	32,000	2,92	45-A NTN
NATR50X	50,000	90,000	32,000	0,99	45 NTN
NATR50X100X38	50,000	100,000	38,000	1,53	45 NTN
NATR50X90X32	50,000	90,000	32,000	0,99	45 NTN
NATR50XLL	50,000	90,000	32,000	2,92	45-A NTN
NATR55X120X68	55,000	120,000	68,000	6,33	45 NTN
NATR5LL	5,000	16,000	12,000	0,04	45-A NTN
NATR5X	5,000	16,000	12,000	0,04	45 NTN
NATR5X14X6	5,000	14,000	6,000	0,01	45 NTN
NATR5XLL	5,000	16,000	12,000	0,04	45-A NTN
NATR6	6,000	19,000	12,000	0,06	45 NTN
NATR60X140X53	60,000	140,000	53,000	9,38	45 NTN
NATR6LL	6,000	19,000	12,000	0,02	45-A NTN
NATR6X	6,000	19,000	12,000	0,06	45 NTN
NATR6XLL	6,000	19,000	12,000	0,06	45-A NTN
NATR8	8,000	24,000	15,000	0,08	45 NTN
NATR85.7X165.1X76.2	85,700	165,100	76,200	8,53	45 NTN
NATR8LL	8,000	24,000	15,000	0,08	45-A NTN
NATR8X	8,000	24,000	15,000	0,08	45 NTN
NATR8XLL	8,000	24,000	15,000	0,12	45-A NTN
NATV30	30,000	62,000	29,000	0,48	46 NTN
NATV30LL	30,000	62,000	29,000	1,41	46 NTN
NATV30X	30,000	62,000	29,000	1,46	46 NTN
NATV30XLL	30,000	62,000	29,000	1,42	46 NTN
NATV35	35,000	72,000	29,000	1,31	46 NTN
NATV35LL	35,000	72,000	29,000	1,91	46 NTN
NATV35X	35,000	72,000	29,000	1,31	46 NTN
NATV35XLL	35,000	72,000	29,000	1,92	46 NTN
NATV40	40,000	80,000	32,000	1,73	46 NTN
NATV40LL	40,000	80,000	32,000	2,53	46 NTN
NATV40X	40,000	80,000	32,000	0,86	46 NTN
NATV40XLL	40,000	80,000	32,000	2,54	46 NTN
NATV5	5,000	16,000	12,000	0,04	46 NTN
NATV50	50,000	90,000	32,000	1,01	46 NTN
NATV50LL	50,000	90,000	32,000	2,95	46 NTN
NATV50X	50,000	90,000	32,000	3,03	46 NTN
NATV50XLL	50,000	90,000	32,000	2,96	46 NTN
NATV5LL	5,000	16,000	12,000	0,04	46 NTN
NATV5X	5,000	16,000	12,000	0,05	46 NTN
NATV5XLL	5,000	16,000	12,000	0,04	46 NTN
NATV6	6,000	19,000	12,000	0,06	46 NTN
NATV6LL	6,000	19,000	12,000	0,06	46 NTN
NATV6X	6,000	19,000	12,000	0,06	46 NTN
NATV6XLL	6,000	19,000	12,000	0,06	46 NTN
NATV8	8,000	24,000	15,000	0,13	46 NTN
NATV8LL	8,000	24,000	15,000	0,04	46 NTN
NATV8X	8,000	24,000	15,000	0,13	46 NTN
NATV8XLL	8,000	24,000	15,000	0,12	46 NTN
NK10/12	10,000	17,000	12,000	0,03	41 NTN
NK10/12+1R 7X10X12	7,000	17,000	12,000	0,03	42 NTN
NK10/16	10,000	17,000	16,000	0,02	41 NTN

Reference	d	D	B	Kg	Brands
NK10/16+1R7X10X16	7,000	17,000	16,000	0,06	42 NTN
NK100/26R	100,000	120,000	26,000	1,47	41 NTN
NK100/26R+1R90X100X26	90,000	120,000	26,000	2,34	42 NTN
NK100/36R	100,000	120,000	36,000	2,07	41 NTN
NK100X250X125	200,000	250,000	125,000	14,80	41 NTN
NK105/26R	105,000	125,000	26,000	1,53	41 NTN
NK105/26R+1R95X105X26	95,000	125,000	26,000	2,40	42 NTN
NK105/36R	105,000	125,000	36,000	1,43	41 NTN
NK105/36R+1R95X105X36	95,000	125,000	36,000	2,29	42 NTN
NK10X110X96	80,000	110,000	96,000	2,53	41 NTN
NK10X125X100	90,000	125,000	100,000	3,36	41 NTN
NK10X17X15	10,000	17,000	15,000	0,04	41 NTN
NK10X59X30.5	40,000	59,000	30,000	0,26	41 NTN
NK10X72X30	50,000	72,000	30,000	1,05	41 NTN
NK110/30R	110,000	130,000	30,000	1,85	41 NTN
NK110/30R+1R100X110X30	100,000	130,000	30,000	2,94	42 NTN
NK110/40R	110,000	130,000	40,000	2,46	41 NTN
NK110/40R+1R100X110X40	100,000	130,000	40,000	1,36	42 NTN
NK12/12	12,000	19,000	12,000	0,03	41 NTN
NK12/12+1R9X12X12	9,000	19,000	12,000	0,06	42 NTN
NK12/16	12,000	19,000	16,000	0,02	41 NTN
NK12/16+1R9X12X16	9,000	19,000	16,000	0,07	42 NTN
NK120/40	120,000	140,000	40,000	1,83	41 NTN
NK120X150X80	120,000	150,000	80,000	6,46	41 NTN
NK12X18X20	12,000	18,000	20,000	0,02	41 NTN
NK12X19X12	12,000	19,000	12,000	0,02	41 NTN
NK12X19X16	12,000	19,000	16,000	0,04	41 NTN
NK12X19X20	12,000	19,000	20,000	0,07	41 NTN
NK12X19X25	12,000	19,000	25,000	0,08	41 NTN
NK12X20X12	12,000	20,000	12,000	0,01	41 NTN
NK130/40	130,000	150,000	40,000	2,94	41 NTN
NK130X165X90	130,000	165,000	90,000	4,74	41 NTN
NK130X280X60	230,000	280,000	60,000	7,57	41 NTN
NK135X188X121	135,000	188,000	120,000	10,59	41 NTN
NK13X21X12	13,000	21,000	12,000	0,04	41 NTN
NK13X25.5X13N	13,000	25,500	13,000	0,09	41 NTN
NK14/16	14,000	22,000	16,000	0,02	41 NTN
NK14/16R	14,000	22,000	16,000	0,06	41 NTN
NK14/16R+1R10X14X16	10,000	22,000	16,000	0,09	42 NTN
NK14/20	14,000	22,000	20,000	0,03	41 NTN
NK14/20R	14,000	22,000	20,000	0,07	41 NTN
NK14/20R+1R10X14X20	10,000	22,000	20,000	0,11	42 NTN
NK145/32	145,000	170,000	32,000	3,34	41 NTN
NK145/42	145,000	170,000	42,000	2,93	41 NTN
NK14X24.5X15N	14,000	24,500	15,000	0,09	41 NTN
NK15/16R	15,000	23,000	16,000	0,02	41 NTN
NK15/20R	15,000	23,000	20,000	0,08	41 NTN
NK155/32	155,000	180,000	32,000	2,37	41 NTN
NK155/42	155,000	180,000	42,000	4,98	41 NTN
NK15X23X12	15,000	23,000	20,000	0,05	41 NTN
NK15X23X16	15,000	23,000	16,000	0,06	41 NTN
NK15X25X17N	15,000	25,000	17,000	0,10	41 NTN

					Brands	
Reference	d	D	B	Kg		
NK15X52.2X15	25,000	52,200	15,000	0,15	41	NTN
NK15X55X27	35,000	55,000	27,000	0,23	41	NTN
NK15X58X20NR	25,000	58,000	20,000	0,87	41	NTN
NK15X75X22	45,000	75,000	22,000	1,32	41	NTN
NK15X80X34	55,000	80,000	34,000	1,53	41	NTN
NK16/16	16,000	24,000	16,000	0,05	41	NTN
NK16/16R	16,000	24,000	16,000	0,07	41	NTN
NK16/16R+1R12X16X16	12,000	24,000	16,000	0,10	42	NTN
NK16/20R	16,000	24,000	20,000	0,08	41	NTN
NK16/20R+1R12X16X20	12,000	24,000	20,000	0,12	42	NTN
NK160X200X105	160,000	200,000	105,000	24,00	41	NTN
NK165/42	165,000	190,000	42,000	1,68	41	NTN
NK16X22X20	16,000	22,000	20,000	0,06	41	NTN
NK16X23X16	16,000	23,000	16,000	0,05	41	NTN
NK16X23X22	16,000	23,000	22,000	0,08	41	NTN
NK16X24X22	16,000	24,000	22,000	0,06	41	NTN
NK16X26X13N	16,000	26,000	13,000	0,08	41	NTN
NK16X62X29.5	36,000	62,000	29,500	0,37	41	NTN
NK16X80X36.5	46,000	80,000	36,500	0,74	41	NTN
NK17.7X30X17	17,700	30,000	17,000	0,08	41	NTN
NK17/16R	17,000	25,000	16,000	0,07	41	NTN
NK17/20R	17,000	25,000	20,000	0,09	41	NTN
NK18/16R	18,000	26,000	16,000	0,07	41	NTN
NK18/20R	18,000	26,000	20,000	0,09	41	NTN
NK180X225X65	180,000	225,000	65,000	9,63	41	NTN
NK18X25X12	18,000	25,000	12,000	0,05	41	NTN
NK18X25X16	18,000	25,000	16,000	0,05	41	NTN
NK18X27X13	18,000	27,000	13,000	0,06	41	NTN
NK18X28X20	18,000	28,000	20,000	0,12	41	NTN
NK18X29X14	18,000	29,000	14,000	0,11	41	NTN
NK19/16R	19,000	27,000	16,000	0,08	41	NTN
NK19/16R+1R15X19X16	15,000	27,000	16,000	0,11	42	NTN
NK19/16R+1R15X19X19	15,000	27,000	19,000	0,04	42	NTN
NK19/20R	19,000	27,000	20,000	0,09	41	NTN
NK19/20R+1R15X19X20	15,000	27,000	20,000	0,14	42	NTN
NK19X34X18N	19,000	34,000	18,000	0,18	41	NTN
NK19X35X20N	19,000	35,000	20,000	0,25	41	NTN
NK1A59/22A	22,000	39,000	23,000	0,24	53	NTN
NK1A5902A	15,000	28,000	18,000	0,15	53	NTN
NK1A5903A	17,000	30,000	18,000	0,17	53	NTN
NK1A5904A	20,000	37,000	23,000	0,33	53	NTN
NK1A5905A	25,000	42,000	23,000	0,25	53	NTN
NK1A5906A	30,000	47,000	23,000	0,45	53	NTN
NK1A5907A	35,000	55,000	27,000	0,74	53	NTN
NK1A5908A	40,000	62,000	30,000	1,04	53	NTN
NK1A5909A	45,000	68,000	30,000	1,32	53	NTN
NK1A5910A	50,000	72,000	30,000	1,26	53	NTN
NK1A5911A	55,000	80,000	34,000	1,18	53	NTN
NK1A5912A	60,000	85,000	34,000	1,25	53	NTN
NK1A5913A	65,000	90,000	34,000	0,68	53	NTN
NK1A5914A	70,000	100,000	40,000	2,13	53	NTN
NK20/16R	20,000	28,000	16,000	0,08	41	NTN

					Brands	
Reference	d	D	B	Kg		
NK20/20R	20,000	28,000	20,000	0,10	41	NTN
NK20X30X15	20,000	30,000	15,000	0,12	41	NTN
NK20X30X15N	20,000	30,000	15,000	0,15	41	NTN
NK20X32X13	20,000	32,000	13,000	0,08	41	NTN
NK20X32X14	20,000	32,000	14,000	0,08	41	NTN
NK20X33X12	20,000	33,000	12,000	0,08	41	NTN
NK20X33X15N	20,000	33,000	15,000	0,15	41	NTN
NK20X34X16	20,000	34,000	16,000	0,05	41	NTN
NK20X34X18	20,000	34,000	18,000	0,20	41	NTN
NK21/16R	21,000	29,000	16,000	0,08	41	NTN
NK21/16R+1R17X21X16	17,000	29,000	16,000	0,12	42	NTN
NK21/20R	21,000	29,000	20,000	0,01	41	NTN
NK21/20R+1R17X21X20	17,000	26,000	20,000	0,10	42	NTN
NK22.2X36X17	22,218	36,000	17,000	0,18	41	NTN
NK22/16R	22,000	30,000	16,000	0,08	41	NTN
NK22/20R	22,000	30,000	20,000	0,11	41	NTN
NK24/16R	24,000	32,000	16,000	0,09	41	NTN
NK24/16R+1R20X24X16	20,000	32,000	16,000	0,14	42	NTN
NK24/20R	24,000	32,000	20,000	0,04	41	NTN
NK24/20R+1R20X24X20	20,000	32,000	20,000	0,18	42	NTN
NK25.5X47X22	25,500	47,000	22,000	0,18	41	NTN
NK25/16R	25,000	33,000	16,000	0,09	41	NTN
NK25/20R	25,000	33,000	20,000	0,08	41	NTN
NK25X33X25	25,000	33,000	25,000	0,06	41	NTN
NK25X33X30	25,000	33,000	30,000	0,18	41	NTN
NK25X45X17.5NR	25,000	45,000	17,500	0,39	41	NTN
NK25X45X18.5NR	25,000	45,000	18,500	0,39	41	NTN
NK26.2X53X56.8	26,200	53,000	56,800	1,97	41	NTN
NK26/16R	26,000	34,000	16,000	0,10	41	NTN
NK26/16R+1R22X26X16	22,000	34,000	16,000	0,10	42	NTN
NK26/20R	26,000	34,000	20,000	0,12	41	NTN
NK26/20R+1R22X26X20	22,000	34,000	20,000	0,13	42	NTN
NK26X35X25	26,000	35,000	25,000	0,19	41	NTN
NK26X35X25.5	26,000	35,000	25,500	0,19	41	NTN
NK27X35X10NR	27,000	35,000	10,000	0,03	41	NTN
NK27X46X21	27,000	46,000	21,000	0,40	41	NTN
NK28/20R	28,000	37,000	20,000	0,15	41	NTN
NK28/30R	28,000	37,000	30,000	0,23	41	NTN
NK28X42X23	28,000	42,000	23,000	0,33	41	NTN
NK28X45X25	28,000	45,000	25,000	0,44	41	NTN
NK29/20R	29,000	38,000	20,000	0,11	41	NTN
NK29/20R+1R25X29X20	25,000	38,000	20,000	0,23	42	NTN
NK29/20R2+1R25X29X20D2	25,000	38,000	40,000	0,47	42	NTN
NK29/30R	29,000	38,000	30,000	0,16	41	NTN
NK29/30R+1R25X29X30	25,000	38,000	30,000	0,24	42	NTN
NK30.5X50X16	30,500	50,000	16,000	0,23	41	NTN
NK30.5X50X17	30,500	50,000	17,000	0,25	41	NTN
NK30.5X50X17+1R22X34X19	24,000	50,000	19,000	0,51	42	NTN
NK30/20R	30,000	40,000	20,000	0,18	41	NTN
NK30/20R1	30,000	40,000	20,000	0,13	41	NTN
NK30/30R	30,000	40,000	30,000	0,19	41	NTN
NK30/30RD2	30,000	40,000	60,000	0,20	41	NTN

Reference	d	D	B	Kg	?	Brands
NK30X42X30	30,000	42,000	30,000	0,22	41	NTN
NK30X47X17	30,000	47,000	17,000	0,29	41	NTN
NK30X50X17N	30,000	50,000	17,000	0,36	41	NTN
NK30X55X21	30,000	55,000	21,000	0,61	41	NTN
NK31X42.1X10NR	31,000	42,100	10,000	0,09	41	NTN
NK32.5X51X23	32,500	51,000	23,000	0,18	41	NTN
NK32.5X53X20.5	32,500	53,000	20,500	0,53	41	NTN
NK32/20R	32,000	42,000	20,000	0,07	41	NTN
NK32/20R+1R28X32X20	28,000	42,000	20,000	0,28	42	NTN
NK32/30R	32,000	42,000	30,000	0,20	41	NTN
NK32/30R+1R28X32X30	28,000	42,000	30,000	0,42	42	NTN
NK32X42X30	32,000	42,000	30,000	0,12	41	NTN
NK32X46X17.7	32,000	46,000	17,700	0,26	41	NTN
NK33.5X47X14	33,500	47,000	14,000	0,20	41	NTN
NK33X47X17NR	33,000	47,000	17,000	0,28	41	NTN
NK35.6X52X24	35,600	52,000	24,000	0,16	41	NTN
NK35/20R	35,000	45,000	20,000	0,21	41	NTN
NK35/20R+1R30X35X20	30,000	45,000	20,000	0,32	42	NTN
NK35/30R	35,000	45,000	30,000	0,31	41	NTN
NK35/30R+1R30X35X30	30,000	45,000	30,000	0,33	42	NTN
NK35X42X30	35,000	42,000	30,000	0,22	41	NTN
NK35X47X30	35,000	47,000	30,000	0,13	41	NTN
NK35X52X33	35,000	52,000	33,000	0,23	41	NTN
NK36X47X11NR	36,000	47,000	11,000	0,16	41	NTN
NK37/20R	37,000	47,000	20,000	0,28	41	NTN
NK37/20R+1R32X37X20	32,000	47,000	20,000	0,34	42	NTN
NK37/30R	37,000	47,000	30,000	0,32	41	NTN
NK37/30R+1R32X37X30	32,000	47,000	30,000	0,51	42	NTN
NK38/20R	38,000	48,000	20,000	0,22	41	NTN
NK38/30R	38,000	48,000	30,000	0,33	41	NTN
NK38X52X27	38,000	52,000	27,000	0,14	41	NTN
NK40/20R	40,000	50,000	20,000	0,24	41	NTN
NK40/20R+1R35X40X20	35,000	50,000	20,000	0,37	42	NTN
NK40/30R	40,000	50,000	30,000	0,24	41	NTN
NK40/30R+1R35X40X30	35,000	50,000	30,000	0,56	42	NTN
NK40X47X31	40,000	47,000	31,000	0,25	41	NTN
NK40X52X12NR	40,000	52,000	12,000	0,14	41	NTN
NK42/20R	42,000	52,000	20,000	0,24	41	NTN
NK42/30R	42,000	52,000	30,000	0,12	41	NTN
NK42X55X36	42,000	55,000	36,000	0,37	41	NTN
NK43/20R	43,000	53,000	20,000	0,25	41	NTN
NK43/20R+1R38X43X20	38,000	53,000	20,000	0,13	42	NTN
NK43/30R	43,000	53,000	30,000	0,39	41	NTN
NK43/30R+1R38X43X30	38,000	53,000	30,000	0,60	42	NTN
NK45.5X78X33	45,550	78,000	33,000	0,63	41	NTN
NK45/20R	45,000	55,000	20,000	0,26	41	NTN
NK45/20R+1R40X45X20	40,000	55,000	20,000	0,27	42	NTN
NK45/30R	45,000	55,000	30,000	0,39	41	NTN
NK45/30R+1R40X45X30	40,000	55,000	30,000	0,62	42	NTN
NK45X54.5X12	45,000	54,500	12,000	0,06	41	NTN
NK45X58X20	45,000	58,000	20,000	0,13	41	NTN
NK45X60X12NR	45,000	60,000	12,000	0,30	41	NTN

Reference	d	D	B	Kg	?	Brands
NK45X60X30	45,000	60,000	30,000	0,66	41	NTN
NK45X64X40D2	45,000	64,000	80,000	0,70	41	NTN
NK46.5X63.3X9	46,500	63,300	9,000	0,27	41	NTN
NK47/20R	47,000	57,000	20,000	0,27	41	NTN
NK47/20R+1R42X47X20	42,000	57,000	20,000	0,43	42	NTN
NK47/30R	47,000	57,000	30,000	0,40	41	NTN
NK47/30R+1R42X47X30	42,000	57,000	30,000	0,64	42	NTN
NK47X57X28.7	47,000	57,000	28,760	0,28	41	NTN
NK48X55X27	48,000	55,000	27,000	0,27	41	NTN
NK5/10	5,000	10,000	10,000	0,01	41	NTN
NK5/12	5,000	10,000	12,000	0,01	41	NTN
NK50/25R	50,000	62,000	25,000	0,15	41	NTN
NK50/25R+1R45X50X25	45,000	62,000	25,000	0,65	42	NTN
NK50/35R	50,000	62,000	35,000	0,62	41	NTN
NK50/35R+1R45X50X35	45,000	62,000	35,000	0,92	42	NTN
NK55/25R	55,000	68,000	25,000	0,54	41	NTN
NK55/25R+1R50X55X25	50,000	68,000	25,000	0,78	42	NTN
NK55/35R	55,000	68,000	35,000	0,76	41	NTN
NK55/35R+1R50X55X35	50,000	68,000	35,000	1,10	42	NTN
NK55X67X20	55,000	67,000	20,000	0,24	41	NTN
NK57.1X90X34	57,160	90,000	34,000	0,78	41	NTN
NK57.7X72X40D2	57,700	72,000	80,000	0,75	41	NTN
NK59.6X80X13.5	59,600	80,000	13,500	0,17	41	NTN
NK6/10	6,000	12,000	10,000	0,01	41	NTN
NK6/12	6,000	12,000	12,000	0,02	41	NTN
NK60/25R	60,000	72,000	25,000	0,52	41	NTN
NK60/25R+1R55X60X25	55,000	72,000	25,000	0,77	42	NTN
NK60/35R	60,000	72,000	35,000	0,73	41	NTN
NK60/35R+1R55X60X35	55,000	72,000	35,000	1,09	42	NTN
NK60X72X25	60,000	72,000	25,000	0,40	41	NTN
NK65/25R	65,000	78,000	25,000	0,63	41	NTN
NK65/35R	65,000	78,000	35,000	0,88	41	NTN
NK68/25R	68,000	82,000	25,000	0,63	41	NTN
NK68/25R+1R60X68X25	60,000	82,000	25,000	1,14	42	NTN
NK68/35R	68,000	82,000	35,000	0,96	41	NTN
NK68/35R+1R60X68X35	60,000	82,000	35,000	1,61	42	NTN
NK7/10	7,000	14,000	10,000	0,02	41	NTN
NK7/12	7,000	14,000	12,000	0,02	41	NTN
NK70/25R	70,000	85,000	25,000	0,77	41	NTN
NK70/35R	70,000	85,000	35,000	1,09	41	NTN
NK70X82X40	70,000	82,000	40,000	1,13	41	NTN
NK73/25R	73,000	90,000	25,000	0,91	41	NTN
NK73/25R+1R65X73X25	65,000	90,000	25,000	1,40	42	NTN
NK73/35R	73,000	90,000	35,000	1,29	41	NTN
NK73/35R+1R65X73X35	65,000	90,000	35,000	1,98	42	NTN
NK75/25R	75,000	92,000	25,000	0,93	41	NTN
NK75/35R	75,000	92,000	35,000	0,49	41	NTN
NK8/12	8,000	15,000	12,000	0,03	41	NTN
NK8/12+1R5X8X12	5,000	15,000	12,000	0,02	42	NTN
NK8/16	8,000	15,000	16,000	0,04	41	NTN
NK8/16+1R5X8X16	5,000	15,000	16,000	0,15	42	NTN
NK80/25R	80,000	95,000	25,000	0,30	41	NTN

Reference	d	D	B	Kg		Brands
NK80/25R+1R70X80X25	70,000	95,000	25,000	1,51	42	NTN
NK80/35R	80,000	95,000	35,000	1,19	41	NTN
NK80/35R+1R70X80X35	70,000	95,000	35,000	1,42	42	NTN
NK80X107.9X88.9	80,000	107,950	88,900	2,44	41	NTN
NK85/25R	85,000	105,000	25,000	0,78	41	NTN
NK85/25R+1R75X85X25	75,000	105,000	25,000	1,28	42	NTN
NK85/35R	85,000	105,000	35,000	1,56	41	NTN
NK85/35R+1R75X85X35	75,000	105,000	35,000	1,81	42	NTN
NK88X110X48	88,000	110,000	48,000	3,35	41	NTN
NK88X110X90	88,000	110,000	90,000	1,76	41	NTN
NK8X15X15	8,000	15,000	15,000	0,04	41	NTN
NK9/12	9,000	16,000	12,000	0,03	41	NTN
NK9/12+1R6X9X12	6,000	16,000	12,000	0,04	42	NTN
NK9/16	9,000	16,000	16,000	0,04	41	NTN
NK9/16+1R6X9X16	6,000	16,000	16,000	0,03	42	NTN
NK90/25R	90,000	110,000	25,000	1,26	41	NTN
NK90/25R+1R80X90X25	80,000	110,000	25,000	1,34	42	NTN
NK90/35R	90,000	110,000	35,000	1,79	41	NTN
NK90/35R+1R80X90X35	80,000	110,000	35,000	2,86	42	NTN
NK95/26R	95,000	115,000	26,000	1,40	41	NTN
NK95/26R+1R85X95X26	85,000	115,000	26,000	2,28	42	NTN
NK95/36R	95,000	115,000	36,000	1,98	41	NTN
NK95/36R+1R85X95X36	85,000	115,000	36,000	3,14	42	NTN
NK95/36RD2	95,000	115,000	72,000	1,32	41	NTN
NKS115	115,000	135,000	32,000	0,70	41	NTN
NKS135	135,000	160,000	40,000	2,66	41	NTN
NKS20	20,000	32,000	20,000	0,12	41	NTN
NKS22	22,000	35,000	20,000	0,07	41	NTN
NKS24R	24,000	37,000	20,000	0,14	41	NTN
NKS25R	25,000	38,000	20,000	0,21	41	NTN
NKS28R	28,000	42,000	20,000	0,25	41	NTN
NKS30	30,000	45,000	22,000	0,37	41	NTN
NKS32	32,000	47,000	22,000	0,39	41	NTN
NKS35	35,000	50,000	22,000	0,42	41	NTN
NKS37	37,000	52,000	22,000	0,29	41	NTN
NKS40	40,000	55,000	22,000	0,47	41	NTN
NKS43	43,000	58,000	22,000	0,52	41	NTN
NKS50	50,000	65,000	22,000	0,59	41	NTN
NKS55	55,000	72,000	22,000	0,75	41	NTN
NKS60	60,000	80,000	28,000	1,25	41	NTN
NKS65	65,000	85,000	28,000	0,71	41	NTN
NKS70R	70,000	90,000	28,000	1,21	41	NTN
NKS8	8,000	16,000	13,000	0,01	41	NTN
NKX10	10,000	24,000	23,000	0,08	49	NTN
NKX10Z	10,000	25,000	23,000	0,12	49	NTN
NKX12	12,000	26,000	23,000	0,13	49	NTN
NKX12Z	12,000	27,000	23,000	0,13	49	NTN
NKX15	15,000	28,000	23,000	0,14	49	NTN
NKX15Z	15,000	29,000	23,000	0,14	49	NTN
NKX17	17,000	30,000	25,000	0,16	49	NTN
NKX17Z	17,000	30,000	25,000	0,17	49	NTN
NKX20	20,000	35,000	30,000	0,26	49	NTN

Reference	d	D	B	Kg		Brands
NKX20Z	20,000	35,000	30,000	0,26	49	NTN
NKX25	25,000	42,000	30,000	0,13	49	NTN
NKX25Z	25,000	42,000	30,000	0,39	49	NTN
NKX30	30,000	47,000	30,000	0,43	49	NTN
NKX30Z	30,000	47,000	30,000	0,44	49	NTN
NKX35	35,000	52,000	30,000	0,17	49	NTN
NKX35Z	35,000	52,000	30,000	0,51	49	NTN
NKX40	40,000	60,000	32,000	0,67	49	NTN
NKX40Z	40,000	60,000	32,000	0,68	49	NTN
NKX45	45,000	65,000	32,000	0,79	49	NTN
NKX45Z	45,000	65,000	32,000	0,27	49	NTN
NKX50	50,000	70,000	35,000	0,91	49	NTN
NKX50Z	50,000	62,000	35,000	0,31	49	NTN
NKX60	60,000	85,000	40,000	1,42	49	NTN
NKX60Z	60,000	86,500	40,000	1,47	49	NTN
NKX70	70,000	95,000	40,000	1,80	49	NTN
NKXR15	15,000	24,000	23,000	0,13	50	NTN
NKXR15Z	15,000	24,000	23,000	0,15	50	NTN
NKXR17	17,000	26,000	25,000	0,11	50	NTN
NKXR17Z	17,000	26,000	25,000	0,17	50	NTN
NKXR20	20,000	30,000	30,000	0,25	50	NTN
NKXR20Z	20,000	30,000	30,000	0,26	50	NTN
NKXR25	25,000	37,000	30,000	0,26	50	NTN
NKXR25Z	25,000	37,000	30,000	0,40	50	NTN
NKXR30	30,000	42,000	30,000	0,14	50	NTN
NKXR30Z	30,000	42,000	30,000	0,43	50	NTN
NKXR35	30,000	52,000	30,000	0,37	50	NTN
NKXR35D2	30,000	42,000	60,000	0,72	50	NTN
NKXR35Z	35,000	47,000	30,000	0,51	50	NTN
NKXR40	40,000	52,000	32,000	0,62	50	NTN
NKXR40Z	40,000	52,000	32,000	0,65	50	NTN
NKXR45	45,000	58,000	32,000	0,74	50	NTN
NKXR45Z	45,000	58,000	32,000	0,80	50	NTN
NKXR50	50,000	62,000	35,000	0,24	50	NTN
NKXR50Z	50,000	62,000	35,000	0,90	50	NTN
NUKR100	36,000	100,000	120,000	9,24	51	NTN
NUKR100X	36,000	100,000	120,000	9,24	51	NTN
NUKR120	42,000	120,000	140,000	15,51	51	NTN
NUKR120X	42,000	120,000	140,000	15,51	51	NTN
NUKR140	48,000	140,000	160,000	23,94	51	NTN
NUKR140X	48,000	140,000	160,000	23,94	51	NTN
NUKR150	52,000	150,000	170,000	19,40	51	NTN
NUKR150X	52,000	150,000	170,000	19,40	51	NTN
NUKR170X	60,000	170,000	190,000	17,20	51	NTN
NUKR180	64,000	180,000	200,000	18,68	51	NTN
NUKR30	12,000	30,000	40,000	0,18	51	NTN
NUKR30X	12,000	30,000	40,000	0,09	51	NTN
NUKR35	16,000	35,000	52,000	0,17	51	NTN
NUKR35X	16,000	35,000	52,000	0,17	51	NTN
NUKR40	18,000	40,000	58,000	0,48	51	NTN
NUKR40X	21,500	40,000	58,000	0,73	51	NTN
NUKR47	25,500	47,000	66,000	1,14	51	NTN

Reference	d	D	B	Kg	Brands	
NUKR47X	25,500	47,000	66,000	1,14	51	NTN
NUKR52	20,000	52,000	66,000	0,45	51	NTN
NUKR52X	20,000	52,000	66,000	1,35	51	NTN
NUKR62	35,000	62,000	80,000	2,39	51	NTN
NUKR62X	35,000	62,000	80,000	2,39	51	NTN
NUKR72	41,500	72,000	80,000	3,03	51	NTN
NUKR72X	24,000	72,000	80,000	3,03	51	NTN
NUKR80	30,000	80,000	100,000	4,62	51	NTN
NUKR80X	47,500	80,000	100,000	4,62	51	NTN
NUKR90	47,500	90,000	100,000	5,88	51	NTN
NUKR90X	47,500	90,000	100,000	5,88	51	NTN
NUKRT100	36,000	100,000	120,000	3,08	51	NTN
NUKRT100X	36,000	100,000	120,000	3,08	51	NTN
NUKRT150X	52,000	150,000	170,000	9,70	51	NTN
NUKRT180X	64,000	180,000	200,000	17,00	51	NTN
NUKRT30X	12,000	30,000	40,000	0,09	51	NTN
NUKRT35	16,000	35,000	52,000	0,20	51	NTN
NUKRT40	18,000	40,000	58,000	0,48	51	NTN
NUKRT40X	18,000	40,000	58,000	0,48	51	NTN
NUKRT47	20,000	47,000	66,000	1,14	51	NTN
NUKRT47X	20,000	47,000	66,000	0,76	51	NTN
NUKRT52	20,000	52,000	66,000	1,35	51	NTN
NUKRT52X	20,000	52,000	66,000	1,35	51	NTN
NUKRT62	24,000	62,000	80,000	0,89	51	NTN
NUKRT72	24,000	72,000	80,000	2,02	51	NTN
NUKRT80	30,000	80,000	100,000	3,08	51	NTN
NUKRT80X	30,000	80,000	100,000	4,62	51	NTN
NUKRT90	30,000	90,000	100,000	1,96	51	NTN
NUKRT90X	30,000	90,000	100,000	1,96	51	NTN
NUKRU100	36,000	100,000	120,000	3,08	51	NTN
NUKRU120	42,000	120,000	140,000	5,17	51	NTN
NUKRU140X	48,000	140,000	160,000	7,98	51	NTN
NUKRU40	18,000	40,000	58,000	0,24	51	NTN
NUKRU47	20,000	47,000	66,000	0,38	51	NTN
NUKRU47X	20,000	47,000	66,000	0,38	51	NTN
NUKRU52X	20,000	52,000	66,000	0,45	51	NTN
NUKRU72X	24,000	72,000	80,000	1,01	51	NTN
NUKRU80	30,000	80,000	100,000	1,54	51	NTN
NUKRU80X	30,000	80,000	100,000	1,54	51	NTN
NUTR202	15,000	35,000	19,000	0,10	52	NTN
NUTR202X	15,000	35,000	19,000	0,30	52	NTN
NUTR203	17,000	40,000	21,000	0,15	52	NTN
NUTR203X	17,000	40,000	21,000	0,44	52	NTN
NUTR204	20,000	47,000	25,000	0,73	52	NTN
NUTR204X	20,000	47,000	25,000	0,73	52	NTN
NUTR205	25,000	52,000	25,000	0,84	52	NTN
NUTR205X	25,000	52,000	25,000	0,84	52	NTN
NUTR206	30,000	62,000	29,000	0,46	52	NTN
NUTR206X	30,000	62,000	29,000	1,39	52	NTN
NUTR207	35,000	72,000	29,000	0,63	52	NTN
NUTR207X	35,000	72,000	29,000	1,89	52	NTN
NUTR208	40,000	80,000	32,000	0,82	52	NTN

Reference	d	D	B	Kg	Brands	
NUTR208X	40,000	80,000	32,000	2,45	52	NTN
NUTR209	45,000	85,000	32,000	2,65	52	NTN
NUTR209X	45,000	85,000	32,000	2,67	52	NTN
NUTR210	50,000	90,000	32,000	2,85	52	NTN
NUTR210X	50,000	90,000	32,000	2,85	52	NTN
NUTR302	15,000	42,000	19,000	0,45	52	NTN
NUTR302X	15,000	42,000	19,000	0,48	52	NTN
NUTR303	17,000	47,000	21,000	0,22	52	NTN
NUTR303X	17,000	47,000	21,000	0,67	52	NTN
NUTR304	20,000	52,000	25,000	0,95	52	NTN
NUTR304X	20,000	52,000	25,000	0,95	52	NTN
NUTR305	25,000	62,000	25,000	1,34	52	NTN
NUTR305X	25,000	62,000	25,000	1,34	52	NTN
NUTR306	30,000	72,000	29,000	2,08	52	NTN
NUTR306X	30,000	72,000	29,000	2,10	52	NTN
NUTR307	35,000	80,000	29,000	2,51	52	NTN
NUTR307X	35,000	80,000	29,000	2,51	52	NTN
NUTR308	40,000	90,000	32,000	3,37	52	NTN
NUTR308X	40,000	90,000	32,000	3,39	52	NTN
NUTR309	45,000	100,000	32,000	4,21	52	NTN
NUTR309X	45,000	100,000	32,000	4,18	52	NTN
NUTR310	50,000	110,000	32,000	5,05	52	NTN
NUTR310X	50,000	110,000	32,000	5,06	52	NTN
PCJ162112	25,400	33,338	19,050	0,10	40	NTN
PCJ162116	25,400	33,338	25,400	0,13	40	NTN
PCJ182420	28,575	38,100	31,750	0,12	40	NTN
PCJ202624	31,750	41,275	38,100	0,23	40	NTN
PCJ222820	34,925	44,450	31,750	0,22	40	NTN
PCJ243016	38,100	47,625	25,400	0,22	40	NTN
PCJ243020	38,100	47,625	31,750	0,19	40	NTN
PCJ243024	38,100	47,625	38,100	0,34	40	NTN
PCJ283416	44,450	53,975	25,400	0,26	40	NTN
PCJ283420	44,450	53,975	31,750	0,22	40	NTN
PCJ283424	44,450	53,975	38,100	0,26	40	NTN
PCJ323816	50,800	60,325	25,400	0,29	40	NTN
PCJ323820	50,800	60,325	31,750	0,24	40	NTN
PCJ323824	50,800	60,325	38,100	0,43	40	NTN
PCJ404616	63,500	73,025	25,400	0,12	40	NTN
PCJ404624	63,500	73,025	38,100	0,36	40	NTN
PK100X116X41.3	100,000	116,000	41,300	1,11	40	NTN
PK100X120X44.7	100,000	120,000	44,700	0,75	40	NTN
PK100X140X60	100,000	140,000	60,000	2,13	40	NTN
PK10X14X7.8	10,000	14,000	7,800	0,01	40	NTN
PK10X14X8.8	10,000	14,000	8,800	0,01	40	NTN
PK10X14X9.8	10,000	14,000	9,800	0,01	40	NTN
PK110X130X59.7	110,000	130,000	59,700	2,34	40	NTN
PK12X16X10.2	12,000	16,000	10,000	0,01	40	NTN
PK12X17X7.8	12,000	17,000	7,800	0,01	40	NTN
PK12X17X9.8	12,000	17,000	9,800	0,02	40	NTN
PK13X19X9.8X3	13,000	19,000	9,800	0,01	40	NTN
PK14X19X11.8	14,000	19,000	11,800	0,02	40	NTN
PK14X19X7.9	14,000	19,000	7,900	0,005	40	NTN

Reference	d	D	B	Kg		Brands
PK14X19X9.7	14,000	19,000	9,700	0,01	40	NTN
PK14X20X11.8	14,000	20,000	11,800	0,03	40	NTN
PK15.8X20.6X17.2	15,875	20,650	17,200	0,03	40	NTN
PK15X20X11.8X	15,000	20,000	11,800	0,02	40	NTN
PK15X20X9.8	15,000	20,000	9,800	0,02	40	NTN
PK15X21X10	15,000	21,000	9,800	0,02	40	NTN
PK15X21X11.8	15,000	21,000	11,800	0,02	40	NTN
PK15X21X9.8	15,000	21,000	9,800	0,02	40	NTN
PK16X21X12.8	16,000	21,000	12,800	0,01	40	NTN
PK16X22X11.8	16,000	22,000	11,800	0,02	40	NTN
PK16X22X16.8	16,000	22,000	16,800	0,03	40	NTN
PK16X23X11.8	16,000	23,000	11,800	0,04	40	NTN
PK17X27X14.8	17,000	27,000	14,800	0,07	40	NTN
PK18X24X11.6	18,000	24,000	11,600	0,03	40	NTN
PK18X24X11.8	18,000	24,000	11,800	0,03	40	NTN
PK18X24X13.2	18,000	24,000	13,200	0,01	40	NTN
PK18X24X13.3	18,000	24,000	13,300	0,02	40	NTN
PK18X27X23.8	18,000	27,000	23,800	0,12	40	NTN
PK18X27X26.8	18,000	27,000	26,800	0,14	40	NTN
PK19X24X13.9	19,000	24,000	13,900	0,02	40	NTN
PK19X25X15.8	19,000	25,000	15,800	0,02	40	NTN
PK19X25X22.8	19,000	25,000	22,800	0,04	40	NTN
PK19X27X20.8	19,000	27,000	20,800	0,03	40	NTN
PK20.5X27.5X11.8	20,500	27,500	11,800	0,04	40	NTN
PK20X26X12.8	20,000	26,000	12,800	0,01	40	NTN
PK20X26X13.8	20,000	26,000	13,800	0,03	40	NTN
PK20X26X16.7	20,000	26,000	16,700	0,05	40	NTN
PK20X26X16.8	20,000	26,000	13,800	0,02	40	NTN
PK20X26X19.8	20,000	26,000	19,800	0,02	40	NTN
PK20X26X20.8	20,000	26,000	20,800	0,02	40	NTN
PK20X27X17	20,000	27,000	17,000	0,07	40	NTN
PK20X28X12.8	20,000	28,000	12,800	0,04	40	NTN
PK20X28X13.8	20,000	28,000	13,800	0,02	40	NTN
PK20X28X15.8	20,000	28,000	15,800	0,02	40	NTN
PK20X29X15.1	20,000	29,000	15,100	0,05	40	NTN
PK20X30X21.8	20,000	30,000	21,800	0,13	40	NTN
PK21.6X29.6X15.8	21,670	29,670	15,800	0,05	40	NTN
PK21X27X19.8	21,000	27,000	19,800	0,06	40	NTN
PK22.2X28.5X31.7	22,200	28,500	31,700	0,11	40	NTN
PK22X28X13.8	22,000	28,000	13,800	0,01	40	NTN
PK22X28X15.8	22,000	28,000	15,800	0,05	40	NTN
PK22X28X16.8	22,000	28,000	16,800	0,06	40	NTN
PK22X29X15.8	22,000	29,000	15,800	0,02	40	NTN
PK22X29X17.8	22,000	29,000	17,800	0,07	40	NTN
PK22X30X14.7	22,000	30,000	14,700	0,02	40	NTN
PK22X30X16.8	22,000	30,000	16,800	0,05	40	NTN
PK22X30X17.8	22,000	30,000	17,800	0,08	40	NTN
PK22X31X16.8	22,000	31,000	16,800	0,62	40	NTN
PK22X31X24.8	22,000	31,000	24,800	0,04	40	NTN
PK23.1X28.1X13.9	23,100	28,100	13,900	0,04	40	NTN
PK24X30X13.8	24,000	30,000	13,800	0,05	40	NTN
PK24X31X16.8	24,000	31,000	16,800	0,02	40	NTN

Reference	d	D	B	Kg		Brands
PK24X32X19.8	24,000	32,000	19,800	0,10	40	NTN
PK25.1X30.1X13.8	25,100	30,100	13,800	0,01	40	NTN
PK25.4X33.3X15.7	25,400	33,300	15,700	0,08	40	NTN
PK25X31X16.8	25,000	31,000	16,800	0,04	40	NTN
PK25X32X15.8	25,000	32,000	15,800	0,05	40	NTN
PK25X33X13.8	25,000	33,000	13,800	0,07	40	NTN
PK25X33X23.8	25,000	33,000	23,800	0,13	40	NTN
PK25X35X13.8	25,000	35,000	13,800	0,07	40	NTN
PK25X35X15.9	25,000	35,000	15,900	0,08	40	NTN
PK25X35X17.4	25,000	35,000	17,400	0,04	40	NTN
PK25X35X24.8	25,000	35,000	24,800	0,16	40	NTN
PK25X36X16.8	25,000	36,000	16,800	0,09	40	NTN
PK26X31X13.8	26,000	31,000	13,800	0,03	40	NTN
PK26X31X9.8	26,000	31,000	9,800	0,03	40	NTN
PK26X32X13.8	26,000	36,000	13,800	0,05	40	NTN
PK26X34X19.8	26,000	34,000	19,800	0,04	40	NTN
PK26X35X24.8	26,000	35,000	24,800	0,17	40	NTN
PK27X32X21.8	27,000	32,000	21,800	0,07	40	NTN
PK27X35X15.8	27,000	35,000	15,800	0,06	40	NTN
PK27X36X20.8	27,000	36,000	20,800	0,14	40	NTN
PK28.5X38.1X25.4	28,500	38,100	25,400	0,18	40	NTN
PK28.5X38.1X27.5	28,500	38,100	27,500	0,06	40	NTN
PK28.5X38.1X31.8	28,575	38,100	31,800	0,23	40	NTN
PK28.5X38.5X21.8	28,500	38,500	21,800	0,06	40	NTN
PK28X33X13.8	28,000	33,000	13,800	0,02	40	NTN
PK28X34X16.8	28,000	34,000	16,800	0,07	40	NTN
PK28X35X13.8	28,000	35,000	13,800	0,07	40	NTN
PK28X35X15.6	28,000	35,000	15,600	0,03	40	NTN
PK28X36X13.8	28,000	36,000	13,800	0,08	40	NTN
PK28X36X15.8	28,000	36,000	15,800	0,09	40	NTN
PK28X37X20.8	28,000	37,000	20,800	0,09	40	NTN
PK28X38X15.8	28,000	38,000	15,800	0,04	40	NTN
PK28X38X16.8	28,000	38,000	16,800	0,08	40	NTN
PK28X38X19.8	28,000	35,000	19,800	0,15	40	NTN
PK28X41X34.5	28,000	41,000	34,500	0,12	40	NTN
PK29X43X42.8	29,000	43,000	42,800	0,57	40	NTN
PK30X37X13.8	30,000	37,000	13,800	0,07	40	NTN
PK30X37X15.9	30,000	37,000	15,900	0,05	40	NTN
PK30X37X19.8	30,000	37,000	19,800	0,04	40	NTN
PK30X38X13.8	30,000	38,000	13,800	0,09	40	NTN
PK30X38X15.8	30,000	38,000	15,800	0,10	40	NTN
PK30X38X17.8	30,000	38,000	17,800	0,04	40	NTN
PK30X38X23.8	30,000	38,000	23,800	0,10	40	NTN
PK30X38X26.3	30,000	38,000	26,300	0,11	40	NTN
PK30X38X37.8	30,000	38,000	37,800	0,29	40	NTN
PK30X40X19.8	30,000	40,000	19,800	0,16	40	NTN
PK30X40X24.8	30,000	40,000	24,800	0,20	40	NTN
PK30X40X28.8	30,000	40,000	28,800	0,07	40	NTN
PK30X42X14.8	30,000	42,000	14,800	0,10	40	NTN
PK30X42X19.8	30,000	42,000	19,800	0,20	40	NTN
PK30X42X22.3	30,000	42,000	22,300	0,22	40	NTN
PK30X42X24.8	30,000	42,000	24,800	0,25	40	NTN

Reference	d	D	B	Kg	Brands
PK30X42X26	30,000	42,000	26,000	0,09	40 NTN
PK30X42X39.8	30,000	42,000	39,800	0,25	40 NTN
PK30X45X25.8	30,000	45,000	25,800	0,11	40 NTN
PK30X45X28.8	30,000	45,000	28,800	0,37	40 NTN
PK31.7X41.2X38.1	31,700	41,200	38,100	0,29	40 NTN
PK31X41X21.4	31,000	41,000	21,400	0,12	40 NTN
PK32X40X17.8	32,000	40,000	17,800	0,08	40 NTN
PK32X40X35.8	32,000	40,000	35,800	0,19	40 NTN
PK32X41X17.8	32,000	41,000	17,800	0,13	40 NTN
PK32X42X16.8	32,000	42,000	16,800	0,14	40 NTN
PK32X43X22.4	32,000	43,000	22,400	0,07	40 NTN
PK32X44X17.8	32,000	44,000	17,800	0,19	40 NTN
PK32X44X32.5	32,000	44,000	32,500	0,11	40 NTN
PK32X45X24.8	32,000	45,000	24,800	0,19	40 NTN
PK33X41X19.8	33,000	41,000	19,800	0,05	40 NTN
PK33X45X24.8	33,000	45,000	24,800	0,27	40 NTN
PK34.9X48.9X19.8	34,925	48,925	19,800	0,28	40 NTN
PK34.9X48.9X27.3	34,925	48,925	27,300	0,37	40 NTN
PK34.9X48.9X32.3	34,925	48,925	32,300	0,44	40 NTN
PK34.9X50.9X29.7	34,925	50,925	29,700	0,16	40 NTN
PK34.9X50.9X45	34,925	50,925	45,000	0,70	40 NTN
PK34X42X19.8	34,000	42,000	19,800	0,09	40 NTN
PK34X43X29.8	34,000	43,000	29,800	0,08	40 NTN
PK34X46X15.8	34,000	46,000	15,800	0,17	40 NTN
PK35.5X43.5X19.8	35,500	43,500	19,800	0,14	40 NTN
PK35X42X19.8	35,000	42,000	19,800	0,11	40 NTN
PK35X43X18.8	35,000	43,000	18,800	0,09	40 NTN
PK35X44X35.6	35,000	44,000	35,600	0,28	40 NTN
PK35X47X24.8	35,000	47,000	24,800	0,28	40 NTN
PK35X47X29.8	35,000	47,000	29,800	0,24	40 NTN
PK35X47X35.8	35,000	47,000	35,800	0,13	40 NTN
PK35X48X30.8	35,000	48,000	30,800	0,36	40 NTN
PK35X49X24.8	35,000	49,000	24,800	0,34	40 NTN
PK35X50X39.8	35,000	50,000	39,800	0,37	40 NTN
PK35X51X20.8	35,000	51,000	20,800	0,22	40 NTN
PK36X48X22.4	36,000	48,000	22,400	0,25	40 NTN
PK36X48X24.9	36,000	48,000	24,900	0,29	40 NTN
PK37X47X24.8	37,000	47,000	24,800	0,25	40 NTN
PK37X52X26.8	37,000	52,000	26,800	0,14	40 NTN
PK38.1X47.6X31.7	38,100	47,600	31,700	0,19	40 NTN
PK38.1X47.6X38.1	38,100	47,600	38,100	0,36	40 NTN
PK38.1X54.1X24.8	38,100	54,100	24,800	0,14	40 NTN
PK38.1X54.1X29.8	38,100	54,100	29,800	0,50	40 NTN
PK38.1X54.1X31.7	38,100	54,100	31,700	0,55	40 NTN
PK38.1X54.1X34.8	38,100	54,100	34,800	0,39	40 NTN
PK38.1X54.1X39.8	38,100	54,100	39,800	0,67	40 NTN
PK38X46X19.8	38,000	46,000	19,800	0,05	40 NTN
PK38X48X22.8	38,000	48,000	22,800	0,23	40 NTN
PK38X52X48.8	38,000	52,000	48,800	0,70	40 NTN
PK38X54X34.8	38,000	54,000	34,800	0,20	40 NTN
PK38XPK53X29.8	38,000	53,000	29,800	0,31	40 NTN
PK39X47X21.8	39,000	47,000	21,800	0,06	40 NTN

Reference	d	D	B	Kg	Brands
PK39X54X22.8	39,000	54,000	22,800	0,12	40 NTN
PK39X55X20.5	39,000	55,000	20,500	0,37	40 NTN
PK39X55X25	39,000	55,000	25,000	0,45	40 NTN
PK40X48X24.8	40,000	48,000	24,800	0,06	40 NTN
PK40X52X17.8	40,000	52,000	17,800	0,23	40 NTN
PK40X55X27.5	40,000	55,000	27,500	0,15	40 NTN
PK40X55X30	40,000	55,000	30,000	0,50	40 NTN
PK40X57X31.5	40,000	57,000	31,500	0,61	40 NTN
PK40X60X29.8	40,000	60,000	29,800	0,23	40 NTN
PK40X60X31.8	40,000	60,000	31,800	0,73	40 NTN
PK40XPK56X20.8	40,000	56,000	20,800	0,25	40 NTN
PK40XPK56X27.5	40,000	56,000	27,500	0,47	40 NTN
PK41.2X57.2X29.8	41,275	57,275	29,800	0,53	40 NTN
PK42.3X51.9X21.5	42,395	51,948	21,500	0,23	40 NTN
PK42X47X28.3	42,000	47,000	28,300	0,04	40 NTN
PK42X57.4X35.8	42,000	57,400	35,800	0,42	40 NTN
PK43X49X29.3	43,000	49,000	29,300	0,06	40 NTN
PK43X63X32.8	43,000	63,000	32,800	0,78	40 NTN
PK44.4X57.1X26.8	44,400	57,100	26,850	0,13	40 NTN
PK44.4X58.4X49.7	44,450	58,450	49,750	0,64	40 NTN
PK44.4X60.4X39.7	44,450	60,450	39,750	0,77	40 NTN
PK44.4X60.4X44.7	44,450	60,450	44,750	0,87	40 NTN
PK44.4XPK53.9X31.7	44,450	53,975	31,750	0,34	40 NTN
PK44.4XPK53.9X38.1	44,450	53,975	38,100	0,41	40 NTN
PK44.4XPK53.9X44.4	44,450	53,975	44,450	0,19	40 NTN
PK44.5X64.5X34	44,500	64,500	34,000	0,56	40 NTN
PK45X57X37.8	45,000	57,000	37,800	0,17	40 NTN
PK45X58X21.8	45,000	58,000	21,800	0,22	40 NTN
PK45X65X54.8	45,000	65,000	54,800	1,04	40 NTN
PK45XPK53X25.8	45,000	53,000	25,800	0,25	40 NTN
PK45XPK53X27.8	45,000	53,000	27,800	0,24	40 NTN
PK45XPK53X31.8	45,000	53,000	31,800	0,09	40 NTN
PK46X62X30	47,000	62,000	30,000	0,38	40 NTN
PK47.2X66.2X26.8	47,200	66,250	26,850	0,41	40 NTN
PK47X65X24.8	47,000	65,000	24,800	0,53	40 NTN
PK47X65X27.4	47,000	65,000	27,400	0,64	40 NTN
PK50.8X64.8X25.4	50,800	64,800	25,400	0,49	40 NTN
PK50.8X64.8X27.7	50,800	64,800	27,750	0,52	40 NTN
PK50.8X64.8X31.7	50,800	64,800	31,750	0,20	40 NTN
PK50.8X64.8X44.5	50,800	64,800	44,500	0,92	40 NTN
PK50.8X66.8X49.8	50,800	66,800	49,800	1,10	40 NTN
PK50.8X70.8X48.8	50,800	70,800	48,800	0,49	40 NTN
PK50X65X41.8	50,000	60,000	41,800	0,57	40 NTN
PK50X71X44.8	50,000	71,000	44,800	1,37	40 NTN
PK52.3X61.9X25.4	52,388	61,913	25,400	0,10	40 NTN
PK52X65X16.8	52,000	65,000	16,800	0,10	40 NTN
PK52X68X34.3	52,000	68,000	34,300	0,51	40 NTN
PK53X73X39.8	53,000	73,000	39,800	0,39	40 NTN
PK55X67X27.3	55,000	67,000	27,300	0,15	40 NTN
PK55X69X24.8	55,000	69,000	24,800	0,47	40 NTN
PK55X69X34.8	55,000	69,000	34,800	0,68	40 NTN
PK55X75X39.8	55,000	75,000	39,800	1,15	40 NTN

Reference	d	D	B	Kg		Brands
PK55X77X35.8	55,000	77,000	35,800	0,77	40	NTN
PK56X72X30.8	56,000	72,000	30,800	0,24	40	NTN
PK57X73X29.8	57,000	73,000	29,800	0,48	40	NTN
PK57X73X49.7	57,000	73,000	49,700	0,44	40	NTN
PK58X80X64.2	58,000	80,000	64,200	2,53	40	NTN
PK59.3X81.9X50.5	59,332	81,998	50,550	0,65	40	NTN
PK60.3X69.8X38.1	60,325	69,850	38,100	0,17	40	NTN
PK60X76X54.8	60,000	76,000	54,800	1,44	40	NTN
PK60X78X29.8	60,000	78,000	29,800	0,88	40	NTN
PK60X82X44.8	60,000	82,000	44,800	1,65	40	NTN
PK60X84X36.8	60,000	84,000	36,800	0,50	40	NTN
PK60X84X38.8	60,000	84,000	38,800	1,56	40	NTN
PK63X77X35.8	63,000	77,000	35,800	0,27	40	NTN
PK65X85X31.7	65,000	85,000	31,700	1,12	40	NTN
PK65X85X43.8	65,000	85,000	43,800	1,02	40	NTN
PK65X89X39.8	65,000	89,000	39,800	1,09	40	NTN
PK65X90X33.8	65,000	90,000	33,800	0,92	40	NTN
PK65X91X54.8	65,000	91,000	54,800	2,48	40	NTN
PK66X76X35.8	66,000	76,000	35,800	0,37	40	NTN
PK70X80X39.8	70,000	80,000	39,800	0,46	40	NTN
PK70X80X44.8	70,000	80,000	44,800	0,29	40	NTN
PK74X90X49.8	74,000	90,000	49,800	1,00	40	NTN
PK74X98X35.8	74,000	98,000	35,800	0,58	40	NTN
PK75X105X49.8	75,000	105,000	49,800	1,01	40	NTN
PK75X83X19.8	75,000	83,000	19,800	0,27	40	NTN
PK75X90X29.8	75,000	90,000	29,800	0,56	40	NTN
PK75X90X41.7	75,000	90,000	41,700	0,77	40	NTN
PK76.2X85.7X31.7	76,200	85,725	31,750	0,17	40	NTN
PK76.2X85.7X38.1	76,200	85,725	38,100	0,41	40	NTN
PK80X100X55.8	80,000	100,000	55,800	2,23	40	NTN
PK80X96X37.8	80,000	96,000	37,800	0,41	40	NTN
PK85X115X58.8	85,000	115,000	58,800	4,13	40	NTN
PK90X105X39.8	90,000	105,000	39,800	0,43	40	NTN
RNA0-100X120X30	100,000	120,000	30,000	1,39	41	NTN
RNA0-100X120X90	100,000	120,000	90,000	2,11	41	NTN
RNA0-10X17X10	10,000	17,000	10,000	0,01	41	NTN
RNA0-10X20X12	10,000	20,000	12,000	0,02	41	NTN
RNA0-10X22X10X	10,000	22,000	10,000	0,06	41	NTN
RNA0-12X22X12	12,000	22,000	12,000	0,06	41	NTN
RNA0-14X22X13	14,000	22,000	13,000	0,04	41	NTN
RNA0-14X22X20ZW	14,000	22,000	20,000	0,03	41	NTN
RNA0-15X23X13	15,000	23,000	13,000	0,04	41	NTN
RNA0-16X24X13	16,000	24,000	13,000	0,06	41	NTN
RNA0-16X24X20ZW	16,000	24,000	20,000	0,07	41	NTN
RNA0-16X24X8X	16,000	24,000	8,000	0,04	41	NTN
RNA0-16X28X12	16,000	28,000	12,000	0,03	41	NTN
RNA0-17X25X13	17,000	25,000	13,000	0,02	41	NTN
RNA0-17X25X26ZW	17,000	25,000	26,000	0,04	41	NTN
RNA0-18X26X13	18,000	26,000	20,000	0,02	41	NTN
RNA0-18X30X12	18,000	30,000	12,000	0,11	41	NTN
RNA0-18X30X24ZW	18,000	30,000	24,000	0,07	41	NTN
RNA0-20X28X13	20,000	28,000	13,000	0,08	41	NTN

Reference	d	D	B	Kg		Brands
RNA0-20X28X26ZW	20,000	28,000	26,000	0,15	41	NTN
RNA0-20X32X12	20,000	32,000	12,000	0,04	41	NTN
RNA0-20X32X24ZW	20,000	32,000	24,000	0,08	41	NTN
RNA0-22X30X13	22,000	30,000	13,000	0,03	41	NTN
RNA0-22X30X26ZW	22,000	30,000	26,000	0,05	41	NTN
RNA0-22X35X16	22,000	35,000	16,000	0,06	41	NTN
RNA0-22X35X32ZW	22,000	35,000	32,000	0,26	41	NTN
RNA0-25X35X17	25,000	35,000	17,000	0,05	41	NTN
RNA0-25X35X26ZW	25,000	35,000	26,000	0,08	41	NTN
RNA0-25X37X32ZW	25,000	37,000	32,000	0,11	41	NTN
RNA0-26X39X13	26,000	39,000	13,000	0,06	41	NTN
RNA0-30X40X17	30,000	40,000	17,000	0,12	41	NTN
RNA0-30X40X26ZW	30,000	40,000	26,000	0,28	41	NTN
RNA0-30X42X32ZW	30,000	42,000	32,000	0,27	41	NTN
RNA0-32X42X13	32,000	42,000	13,000	0,10	41	NTN
RNA0-35X45X13	35,000	45,000	13,000	0,05	41	NTN
RNA0-35X45X17	35,000	45,000	17,000	0,07	41	NTN
RNA0-35X45X26ZW	35,000	45,000	26,000	0,32	41	NTN
RNA0-35X47X32ZW	35,000	47,000	32,000	0,36	41	NTN
RNA0-37X47X13	37,000	47,000	13,000	0,05	41	NTN
RNA0-37X52X18	37,000	52,000	18,000	0,25	41	NTN
RNA0-40X50X17	40,000	50,000	17,000	0,15	41	NTN
RNA0-40X50X34ZW	40,000	50,000	34,000	0,46	41	NTN
RNA0-40X55X20	40,000	55,000	20,000	0,45	41	NTN
RNA0-40X55X40ZW	40,000	55,000	40,000	0,58	41	NTN
RNA0-45X55X17	45,000	55,000	17,000	0,17	41	NTN
RNA0-45X62X20	45,000	62,000	20,000	0,19	41	NTN
RNA0-45X62X40ZW	45,000	62,000	40,000	0,75	41	NTN
RNA0-4X10X7X	4,000	10,000	7,000	0,01	41	NTN
RNA0-50X62X40ZW	50,000	62,000	40,000	0,27	41	NTN
RNA0-50X65X40ZW	50,000	65,000	40,000	0,35	41	NTN
RNA0-55X68X20	55,000	68,000	20,000	0,17	41	NTN
RNA0-55X68X40	55,000	68,000	40,000	0,34	41	NTN
RNA0-55X72X40ZW	55,000	72,000	40,000	0,45	41	NTN
RNA0-5X10X8	5,000	10,000	8,000	0,004	41	NTN
RNA0-60X78X20	60,000	78,000	20,000	0,52	41	NTN
RNA0-60X78X40ZW	60,000	78,000	40,000	1,59	41	NTN
RNA0-65X85X30	65,000	85,000	30,000	0,48	41	NTN
RNA0-65X85X60ZW	65,000	85,000	60,000	1,90	41	NTN
RNA0-6X12X7X	6,000	12,000	7,000	0,01	41	NTN
RNA0-6X12X8X	6,000	12,000	8,000	0,01	41	NTN
RNA0-6X13X8	6,000	13,000	8,000	0,01	41	NTN
RNA0-70X90X30	70,000	90,000	30,000	0,51	41	NTN
RNA0-70X90X60ZW	70,000	90,000	60,000	3,05	41	NTN
RNA0-75X95X30	75,000	95,000	30,000	0,54	41	NTN
RNA0-75X95X60ZW	75,000	95,000	60,000	2,16	41	NTN
RNA0-7X14X8	7,000	14,000	8,000	0,01	41	NTN
RNA0-80X100X30	80,000	100,000	30,000	1,14	41	NTN
RNA0-80X100X60ZW	80,000	100,000	60,000	2,28	41	NTN
RNA0-80X95X30	80,000	95,000	30,000	0,82	41	NTN
RNA0-80X95X56ZW	80,000	95,000	56,000	1,47	41	NTN
RNA0-8X15X10	8,000	15,000	10,000	0,01	41	NTN

Reference	d	D	B	Kg	?	Brands
RNA22/6LL	10,000	19,000	11,800	0,05	41	NTN
RNA22/6XLL	10,000	19,000	11,800	0,05	41	NTN
RNA22/8LL	12,000	24,000	11,800	0,08	41	NTN
RNA22/8XLL	12,000	24,000	11,800	0,08	41	NTN
RNA2200LL	14,000	30,000	13,800	0,16	41	NTN
RNA2200XLL	14,000	30,000	13,800	0,18	41	NTN
RNA2201LL	16,000	32,000	13,800	0,17	41	NTN
RNA2202LL	20,000	35,000	13,800	0,19	41	NTN
RNA2202XLL	20,000	35,000	13,800	0,13	41	NTN
RNA2203LL	22,000	40,000	15,800	0,29	41	NTN
RNA2203XLL	22,000	40,000	15,800	0,29	41	NTN
RNA2204LL	25,000	47,000	17,800	0,47	41	NTN
RNA2204XLL	25,000	47,000	17,800	0,47	41	NTN
RNA2205LL	30,000	52,000	17,800	0,18	41	NTN
RNA2205XLL	30,000	52,000	17,800	0,53	41	NTN
RNA2206LL	35,000	62,000	19,800	0,88	41	NTN
RNA2206XLL	35,000	62,000	19,800	0,58	41	NTN
RNA2207LL	42,000	72,000	22,700	0,87	41	NTN
RNA2208LL	48,000	80,000	22,700	1,05	41	NTN
RNA2209LL	52,000	85,000	22,700	0,55	41	NTN
RNA2209XLL	52,000	85,000	22,700	0,58	41	NTN
RNA2210LL	58,000	90,000	22,700	0,61	41	NTN
RNA2210XLL	58,000	90,000	22,700	1,69	41	NTN
RNA4822	120,000	140,000	30,000	1,34	41	NTN
RNA4824	130,000	150,000	30,000	2,20	41	NTN
RNA4826	145,000	165,000	35,000	2,82	41	NTN
RNA4828	155,000	175,000	35,000	2,00	41	NTN
RNA4830	165,000	190,000	40,000	4,81	41	NTN
RNA4832	175,000	200,000	40,000	5,11	41	NTN
RNA4834	185,000	215,000	45,000	7,59	41	NTN
RNA4836	195,000	225,000	45,000	8,01	41	NTN
RNA4838	210,000	240,000	50,000	9,60	41	NTN
RNA4840	220,000	250,000	50,000	10,05	41	NTN
RNA4844	240,000	270,000	50,000	10,80	41	NTN
RNA4848	265,000	300,000	60,000	16,47	41	NTN
RNA4852	285,000	320,000	60,000	17,67	41	NTN
RNA4856	305,000	350,000	69,000	18,78	41	NTN
RNA4860	330,000	380,000	80,000	25,56	41	NTN
RNA4864	350,000	400,000	80,000	29,00	41	NTN
RNA4868	370,000	420,000	80,000	14,12	41	NTN
RNA4872	390,000	440,000	80,000	14,80	41	NTN
RNA4876	415,000	480,000	100,000	26,04	41	NTN
RNA49/22R	28,000	39,000	17,000	0,10	41	NTN
RNA49/28R	32,000	45,000	17,000	0,22	41	NTN
RNA49/32R	40,000	52,000	20,000	0,19	41	NTN
RNA4900L	14,000	22,000	13,000	0,05	41	NTN
RNA4900LL	14,000	22,000	13,000	0,05	41	NTN
RNA4900R	14,000	22,000	13,000	0,03	41	NTN
RNA4901L	16,000	24,000	13,000	0,02	41	NTN
RNA4901LL	16,000	24,000	13,000	0,07	41	NTN
RNA4901R	12,000	24,000	13,000	0,05	41	NTN
RNA4902	20,000	28,000	13,000	0,05	41	NTN

Reference	d	D	B	Kg	?	Brands
RNA4902L	20,000	28,000	13,000	0,07	41	NTN
RNA4902LL	20,000	28,000	13,000	0,07	41	NTN
RNA4902R+1R16X20X13X	16,000	28,000	13,000	0,10	41	NTN
RNA4903	17,000	30,000	13,000	0,03	41	NTN
RNA4903LL	22,000	30,000	13,000	0,08	41	NTN
RNA4904L	25,000	37,000	17,000	0,21	41	NTN
RNA4904LL	25,000	37,000	17,000	0,19	41	NTN
RNA4904R	25,000	37,000	17,000	0,05	41	NTN
RNA4904RLL	25,000	37,000	17,000	0,16	41	NTN
RNA4905L	30,000	42,000	17,000	0,22	41	NTN
RNA4905LL	30,000	42,000	17,000	0,21	41	NTN
RNA4905R	30,000	42,000	17,000	0,12	41	NTN
RNA4905RLL	30,000	42,000	17,000	0,06	41	NTN
RNA4905S	30,000	42,000	17,000	0,06	41	NTN
RNA4906L	35,000	47,000	17,000	0,08	41	NTN
RNA4906LL	35,000	47,000	17,000	0,24	41	NTN
RNA4906R	35,000	47,000	17,000	0,14	41	NTN
RNA4906R+1R25X35X17	25,000	47,000	17,000	0,13	41	NTN
RNA4906RLL	35,000	47,000	17,000	0,22	41	NTN
RNA4907L	42,000	55,000	20,000	0,30	41	NTN
RNA4907LL	42,000	55,000	20,000	0,37	41	NTN
RNA4907R	42,000	55,000	20,000	0,21	41	NTN
RNA4908LL	48,000	62,000	22,000	0,51	41	NTN
RNA4908R	48,000	62,000	22,000	0,42	41	NTN
RNA4909LL	52,000	68,000	22,000	0,43	41	NTN
RNA4909R	52,000	68,000	22,000	0,55	41	NTN
RNA4910LL	58,000	72,000	22,000	0,59	41	NTN
RNA4910R	58,000	72,000	22,000	0,50	41	NTN
RNA4911R	63,000	80,000	25,000	0,78	41	NTN
RNA4912R	68,000	85,000	25,000	0,83	41	NTN
RNA4913R	72,000	90,000	25,000	0,95	41	NTN
RNA4914R	80,000	100,000	30,000	1,52	41	NTN
RNA4915R	85,000	105,000	30,000	1,46	41	NTN
RNA4916R	90,000	110,000	30,000	1,58	41	NTN
RNA4917R	100,000	120,000	35,000	1,32	41	NTN
RNA4918R	105,000	125,000	35,000	2,09	41	NTN
RNA4919R	110,000	130,000	35,000	2,13	41	NTN
RNA4920	115,000	140,000	40,000	3,42	41	NTN
RNA4922	125,000	150,000	40,000	3,66	41	NTN
RNA4924	135,000	165,000	45,000	5,52	41	NTN
RNA4926	150,000	180,000	50,000	6,69	41	NTN
RNA4928	160,000	190,000	50,000	7,04	41	NTN
RNA4930	170,000	210,000	60,000	12,96	41	NTN
RNA4932	180,000	220,000	60,000	13,59	41	NTN
RNA4934	190,000	230,000	60,000	9,54	41	NTN
RNA4936	205,000	250,000	69,000	19,59	41	NTN
RNA4938	215,000	260,000	69,000	13,64	41	NTN
RNA4940	225,000	280,000	80,000	20,60	41	NTN
RNA4944	245,000	300,000	80,000	33,30	41	NTN
RNA4948	265,000	320,000	80,000	23,60	41	NTN
RNA495	5,000	13,000	10,000	0,01	41	NTN
RNA4952	290,000	360,000	100,000	31,80	41	NTN

Reference	d	D	B	Kg	?	Brands
RNA496	8,000	15,000	10,000	0,02	41	NTN
RNA4968	380,000	460,000	118,000	14,00	41	NTN
RNA498	10,000	19,000	11,000	0,04	41	NTN
RNA4988	490,000	600,000	160,000	194,20	41	NTN
RNA499	12,000	20,000	11,000	0,04	41	NTN
RNA59/22	28,000	39,000	23,000	0,02	41	NTN
RNA59/28	32,000	45,000	23,000	0,22	41	NTN
RNA59/32	40,000	52,000	27,000	0,37	41	NTN
RNA5903	22,000	30,000	18,000	0,09	41	NTN
RNA5904	25,000	37,000	23,000	0,08	41	NTN
RNA5905	30,000	38,000	23,000	0,17	41	NTN
RNA5906	35,000	47,000	23,000	0,28	41	NTN
RNA5907	42,000	55,000	27,000	0,30	41	NTN
RNA5908	48,000	62,000	30,000	0,64	41	NTN
RNA5909	52,000	68,000	30,000	0,79	41	NTN
RNA5910	58,000	72,000	30,000	0,70	41	NTN
RNA5911	63,000	80,000	34,000	1,14	41	NTN
RNA5912	68,000	85,000	34,000	1,20	41	NTN
RNA5913	72,000	90,000	34,000	1,37	41	NTN
RNA5914	80,000	100,000	40,000	1,28	41	NTN
RNA5915	85,000	105,000	40,000	1,28	41	NTN
RNA5916	90,000	110,000	40,000	2,13	41	NTN
RNA5917	100,000	120,000	46,000	2,67	41	NTN
RNA5918	105,000	125,000	46,000	2,84	41	NTN
RNA5919	110,000	130,000	46,000	2,67	41	NTN
RNA5920	115,000	140,000	54,000	4,48	41	NTN
RNA5922	125,000	150,000	54,000	5,19	41	NTN
RNA5924	135,000	165,000	60,000	5,11	41	NTN
RNA5926	150,000	180,000	67,000	11,13	41	NTN
RNA5928	160,000	190,000	67,000	9,88	41	NTN
RNA69/22R	28,000	39,000	30,000	0,18	41	NTN
RNA69/28R	32,000	45,000	30,000	0,26	41	NTN
RNA69/32	40,000	52,000	36,000	0,40	41	NTN
RNA69/32R	40,000	52,000	36,000	0,50	41	NTN
RNA6901R	16,000	24,000	22,000	0,09	41	NTN
RNA6902R	20,000	28,000	23,000	0,11	41	NTN
RNA6903R	22,000	30,000	23,000	0,12	41	NTN
RNA6904R	30,000	42,000	30,000	0,28	41	NTN
RNA6905R	30,000	42,000	30,000	0,33	41	NTN
RNA6906R	35,000	47,000	30,000	0,13	41	NTN
RNA6907	42,000	55,000	36,000	0,23	41	NTN
RNA6907R	42,000	55,000	36,000	0,39	41	NTN
RNA6908R	48,000	62,000	40,000	0,76	41	NTN
RNA6909R	52,000	68,000	40,000	1,02	41	NTN
RNA6910R	58,000	72,000	40,000	0,60	41	NTN
RNA6911R	63,000	80,000	25,000	1,49	41	NTN
RNA6912R	68,000	85,000	35,000	1,52	41	NTN
RNA6913R	72,000	90,000	45,000	1,70	41	NTN
RNA6914R	80,000	100,000	54,000	1,66	41	NTN
RNA6915R	85,000	105,000	54,000	2,59	41	NTN
RNA6916R	90,000	110,000	54,000	2,76	41	NTN
RNA6917R	100,000	120,000	63,000	3,60	41	NTN

Reference	d	D	B	Kg	?	Brands
RNA6918R	105,000	125,000	63,000	3,80	41	NTN
RNA6919	110,000	130,000	63,000	4,73	41	NTN
RNA6919R	110,000	130,000	63,000	3,89	41	NTN
RNA62/5	7,000	16,000	8,000	0,01	43-A	NTN
RNA62/5X	7,000	16,000	8,000	0,02	43-A	NTN
RNA62/6	10,000	19,000	10,000	0,03	43-A	NTN
RNA62/6X	10,000	19,000	10,000	0,03	43-A	NTN
RNA62/8	12,000	24,000	10,000	0,07	43-A	NTN
RNA62/8X	12,000	24,000	10,000	0,05	43-A	NTN
RNA6200	14,000	30,000	12,000	0,05	43-A	NTN
RNA6200X	14,000	30,000	12,000	0,09	43-A	NTN
RNA6201	16,000	32,000	12,000	0,10	43-A	NTN
RNA6201X	16,000	32,000	12,000	0,05	43-A	NTN
RNA6202	20,000	35,000	12,000	0,10	43-A	NTN
RNA6202X	20,000	35,000	12,000	0,16	43-A	NTN
RNA6203	22,000	40,000	16,000	0,29	43-A	NTN
RNA6203X	22,000	40,000	16,000	0,10	43-A	NTN
RNA6204X	25,000	47,000	16,000	0,40	43-A	NTN
RNA6205	30,000	52,000	16,000	0,46	43-A	NTN
RNA6205X	30,000	52,000	16,000	0,15	43-A	NTN
RNA6208	50,000	80,000	20,000	1,29	43-A	NTN
WS81100	10,000	24,000	2,750	0,02	58	NTN
WS81101	12,000	26,000	2,750	0,03	58	NTN
WS81102	15,000	28,000	2,750	0,02	58	NTN
WS81103	17,000	30,000	2,750	0,03	58	NTN
WS81104	20,000	35,000	2,750	0,04	58	NTN
WS81105	25,000	42,000	3,000	0,06	58	NTN
WS81106	30,000	47,000	3,000	0,07	58	NTN
WS81107	35,000	52,000	3,500	0,09	58	NTN
WS81108	40,000	60,000	3,500	0,12	58	NTN
WS81109	45,000	65,000	4,000	0,10	58	NTN
WS81110	50,000	70,000	4,000	0,17	58	NTN
WS81111	55,000	78,000	5,000	0,27	58	NTN
WS81112	60,000	85,000	4,750	0,30	58	NTN
WS81113	65,000	90,000	5,250	0,24	58	NTN
WS81114	70,000	95,000	5,250	0,38	58	NTN
WS81115	75,000	100,000	5,750	0,44	58	NTN
WS81116	80,000	105,000	5,750	0,47	58	NTN
WS81117	85,000	110,000	5,750	0,17	58	NTN
WS81118	90,000	120,000	6,500	0,72	58	NTN
WS81120	100,000	135,000	7,000	1,01	58	NTN
WS81122	110,000	145,000	7,000	1,11	58	NTN
WS81124	120,000	155,000	7,000	1,19	58	NTN
WS81126	130,000	170,000	9,000	1,94	58	NTN
WS81128	140,000	178,000	9,500	1,37	58	NTN
WS81130	150,000	188,000	9,500	2,19	58	NTN
WS81132	160,000	198,000	9,500	2,32	58	NTN
WS81206	30,000	52,000	4,250	0,13	58	NTN
WS81207	35,000	62,000	5,250	0,24	58	NTN
WS81208	40,000	68,000	5,000	0,26	58	NTN
WS81209	45,000	73,000	5,500	0,32	58	NTN
WS81210	50,000	78,000	6,500	0,41	58	NTN

Reference	d	D	B	Kg	Brands
WS81211	55,000	90,000	7,000	0,63	58 NTN
WS81212	60,000	95,000	7,500	0,72	58 NTN
WS81213	65,000	100,000	8,000	0,83	58 NTN
WS81214	70,000	105,000	8,000	0,87	58 NTN
WS81215	75,000	110,000	8,000	0,92	58 NTN
WS81216	80,000	115,000	8,500	1,04	58 NTN
WS81217	85,000	125,000	9,500	1,43	58 NTN
WS81218	90,000	135,000	10,500	0,95	58 NTN
WS81220	100,000	150,000	11,500	2,58	58 NTN
WS81222	110,000	160,000	11,500	1,86	58 NTN
WS81224	120,000	170,000	12,000	3,12	58 NTN
WS81226	130,000	187,000	13,000	4,22	58 NTN
WS81228	140,000	197,000	13,500	1,55	58 NTN
WS81234	170,000	237,000	16,500	2,76	58 NTN
WS87408	40,000	90,000	8,250	0,33	58 NTN
WS87414	70,000	150,000	12,500	2,63	58 NTN
WS87415	75,000	160,000	13,000	1,59	58 NTN
WS89306	30,000	60,000	6,250	0,20	58 NTN
WS89307	35,000	68,000	7,000	0,28	58 NTN
WS89308	40,000	78,000	7,500	0,60	58 NTN
WS89309	45,000	85,000	8,250	0,77	58 NTN
WS89310	50,000	95,000	9,500	0,74	58 NTN
WS89311	55,000	105,000	10,500	1,00	58 NTN
WS89312	60,000	110,000	10,500	1,59	58 NTN
WS89313	65,000	115,000	10,500	1,13	58 NTN
WS89314	70,000	125,000	12,000	1,55	58 NTN
WS89315	75,000	135,000	12,500	1,88	58 NTN
WS89316	80,000	140,000	12,500	2,96	58 NTN
WS89317	85,000	150,000	13,500	1,24	58 NTN
WS89318	90,000	155,000	13,500	3,86	58 NTN
WS89320	100,000	170,000	14,500	1,46	58 NTN
WS89322	110,000	190,000	16,500	2,38	58 NTN
XS100X135X4	100,000	135,000	4,000	0,20	58 NTN
XS10X24X2.7	10,000	24,000	2,750	0,01	58 NTN
XS120X155X4	120,000	155,000	4,000	0,60	58 NTN
XS12X35X3	12,000	35,000	3,000	0,02	58 NTN
XS13.1X29X1.5	13,100	29,000	1,530	0,02	58 NTN
XS13X35X3	13,000	35,000	3,000	0,04	58 NTN
XS13X42X3	13,000	42,000	3,000	0,08	58 NTN
XS14X31X3.5	14,000	31,000	3,500	0,05	58 NTN
XS16X28X3	16,000	28,000	3,000	0,01	58 NTN
XS17.5X30X1.5	17,500	30,000	1,500	0,02	58 NTN
XS17X30X2.7	17,000	30,000	27,500	0,03	58 NTN
XS17X42X3	17,000	42,000	3,000	0,03	58 NTN
XS18X44X3	18,000	44,000	3,000	0,08	58 NTN
XS20.5X35X1.5	20,500	35,000	1,500	0,02	58 NTN
XS20X35X2.7	20,000	35,000	2,750	0,03	58 NTN
XS21X40X3.2	21,000	40,000	3,200	0,02	58 NTN
XS22X36.8X3	22,000	36,800	3,000	0,02	58 NTN
XS23X62X3	22,000	62,000	3,000	0,17	58 NTN
XS26.5X42X2	26,500	42,000	2,000	0,03	58 NTN
XS26X42X4	26,000	42,000	4,000	0,08	58 NTN

Reference	d	D	B	Kg	Brands
XS27.5X56X3	27,500	56,000	3,000	0,09	58 NTN
XS27.5X72X3	27,500	72,000	3,000	0,09	58 NTN
XS28.1X42.1X10.1	28,190	42,164	10,185	0,06	58 NTN
XS28.7X37.8X2.2	28,780	37,850	2,200	0,02	58 NTN
XS30X47X6	30,000	47,000	6,000	0,14	58 NTN
XS30X59.3X3	30,000	59,300	3,000	0,14	58 NTN
XS31.8X59X3.5	31,830	59,000	3,500	0,05	58 NTN
XS32.5X65X3	32,500	65,000	3,000	0,05	58 NTN
XS32X45.3X2	32,000	45,300	2,000	0,01	58 NTN
XS32X47X2	32,000	47,000	2,000	0,04	58 NTN
XS32X47X3	32,000	47,000	3,000	0,04	58 NTN
XS32X48X2	32,000	48,000	2,000	0,03	58 NTN
XS35X52X2	35,000	52,000	2,000	0,03	58 NTN
XS35X56X5	35,000	56,000	5,000	0,11	58 NTN
XS35X62X5.2	35,000	62,000	5,250	0,17	58 NTN
XS37X48.9X1.9	37,000	48,900	1,900	0,04	58 NTN
XS37X48.9X2	37,000	48,900	2,000	0,04	58 NTN
XS38X52X3.5	38,000	52,000	3,500	0,02	58 NTN
XS39.5X62X2.5	39,500	62,000	2,500	0,07	58 NTN
XS39.8X53X4	39,800	53,000	4,000	0,06	58 NTN
XS40.5X54X3	40,500	54,000	3,000	0,05	58 NTN
XS43X54.6X3	43,000	54,600	3,000	0,04	58 NTN
XS47X100X4	47,000	100,000	4,000	0,18	58 NTN
XS48.2X72X4	48,200	72,000	4,000	0,14	58 NTN
XS53.6X114X8	53,600	114,000	8,000	0,36	58 NTN
XS55X78X3	55,000	78,000	3,000	0,10	58 NTN
XS60X80X2.5	60,000	80,000	2,500	0,04	58 NTN
XS60X85X3	60,000	85,000	3,000	0,16	58 NTN
XS60X85X4.2	60,000	85,000	4,200	0,09	58 NTN
XS65X90X2.5	65,000	90,000	2,500	0,11	58 NTN
XS65X90X3	65,000	90,000	3,000	0,13	58 NTN
XS70X105X4	70,000	105,000	4,000	0,15	58 NTN
XS70X95.1X3	70,050	95,170	3,040	0,07	58 NTN
XS8.5X24X3	8,500	24,000	3,000	0,03	58 NTN
XS8.5X25X3	8,500	25,000	3,000	0,01	58 NTN
XS8.5X30X3	8,500	30,000	3,000	0,04	58 NTN
XS80X105X3.4	80,000	105,000	3,400	0,18	58 NTN
XS89X127X4	89,000	127,000	4,000	0,39	58 NTN



Bearing units/
Pillow blocks



Gehäuselager/
Gehäuse



Soportes autoalineantes /
Soportes



Подшипниковые узлы



Paliers auto-aligneurs /
Paliers



Supporti orientabili /
Supporti in due parti



Mancais auto-alinháveis /
Mancais bipartidos



Zespoły łożyskowe



Classification by references – Classification par références

Klassifizierung nach Referenzen – Classificazione per codice

Clasificación por referencias – Classificação por referências





Классификация по кодам – Klasyfikacja wg numerów katalogowych

**NTN Self-aligning bearing units / Paliers auto-aligneurs NTN / NTN Gehäuselager /
Supporti orientabili NTN / Soportes autoalineantes NTN / Mancais auto-alinháveis /
Самоустанавливающиеся подшипниковые узлы NTN / Samonastawne zespoły łożyskowe NTN**

Bearing unit ⁽¹⁾	Insert bearing ⁽²⁾	UC	UEL	UK	AS	AEL	CS
P Cast iron ⁽³⁾		UCP UCPX	UELP	UKP UKPX	ASP	AELP	
UP (PW) Cast iron ⁽³⁾		UCPW UCUP			ASPW ASUP	AELPW ALEUP	
PP Pressed steel ⁽⁴⁾					ASPP	AELPP	CSPP
F Cast iron ⁽³⁾		UCF UCFX	UELF	UKF	ASF	AELF	
FS With eccentric collar ⁽⁵⁾ Cast iron ⁽³⁾		UCFS	UELFS	UKFS UKFX			
FC With eccentric collar ⁽⁵⁾ Cast iron ⁽³⁾		UCFC	UELFC	UKFC		AELFC	
FL Cast iron ⁽³⁾		UCFL UCFD	UELFL	UKFL	ASFL	AELFL	
FB (FW) Cast iron ⁽³⁾					ASFD ASFB ASFW	AELFD AELFB AELFW	
FA Cast iron ⁽³⁾		UCFA	UELFA		ASFA	AELFA	
PF Pressed steel ⁽⁴⁾					ASPF	AELPF	CSPF
PFL Pressed steel ⁽⁴⁾					ASPFL	AELPFL	CSPFL
Bearing with cylindrical outer ring ⁽⁶⁾		UCS	UELS		ASS	AELS	
C Cast iron ⁽³⁾		UCC	UELC	UKC	ASC	AELC	
T Cast iron ⁽³⁾		UCT UCTX	UULT	UKT UKTX		AELT	
HB Cast iron ⁽³⁾		UCHB					
PT				ASPT	AELPT		
T		UCT	UULT			AELT	
L M		UCL UCM					
Bearing with cylindrical outer ring ⁽⁶⁾		UCS	UELS		ASS	AELS	

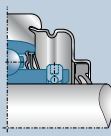
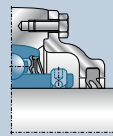
- (1) Bearing unit - (2) Insert bearing unit - (3) Cast iron - (4) Pressed steel - (5) With eccentric collar - (6) Bearing with cylindrical outer ring
 (1) Corps de palier - (2) Roulement insert - (3) Fonte - (4) Tôle - (5) Avec épaulement de centrage - (6) Roulement avec bague extérieure cylindrique
 (1) Gehäuse - (2) Einsatz - (3) Guss - (4) Blech - (5) Mit Zentrierungsabsatz - (6) Lager mit zylinderförmigem Außenring
 (1) Corpo esterno - (2) Inserti - (3) Ghisa - (4) Lameria in acciaio - (5) Con centraggio - (6) Cuscinetto con anello esterno cilindrico
 (1) Cuerpo - (2) Rodamiento inserto - (3) Fundición - (4) Chapa - (5) Con respaldo de centrado - (6) Rodamiento con anillo exterior cilíndrico
 (1) Corpo - (2) Rolamentos abaulados - (3) Ferro fundido - (4) Chapa - (5) Com saliência de centralização - (6) Rolamento com anel exterior cilíndrico
 (1) Корпус подшипника - (2) Корпусной подшипник - (3) Чугун - (4) Штампованная сталь - (5) С эксцентриковым кольцом - (6) Подшипник с цилиндрическим наружным кольцом
 (1) Zespół łożyskowy - (2) Łożysko samonastawne - (3) Żeliwo - (4) Blacha - (5) Z odsadzeniem centrującym - (6) Łożysko z walcowym pierścieniem zewnętrznym

NTN Self-aligning bearing units / Paliers auto-aligneurs NTN / NTN Gehäuselager /
 Supporti orientabili NTN / Soportes autoalineantes NTN / Mancais auto-alinháveis /
 Самоустанавливающиеся подшипниковые узлы NTN / Samonastawne zespoły łożyskowe NTN

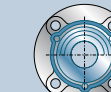
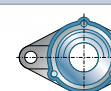
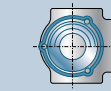
Bearing unit ⁽¹⁾	Insert bearing ⁽²⁾	UC	UEL	UK	AS	AEL	CS
Cast iron bearing units with protective caps ⁽³⁾	Pressed steel protective cap ⁽⁴⁾			Cast iron protective cap ⁽⁵⁾			
S- / C- Opened on both sides ⁽⁶⁾							
SM- / CM- Closed on one side ⁽⁷⁾	S-protective caps ⁽⁸⁾			C-protective caps ⁽⁹⁾			
S(M)-P C(M)-P		S-UCP C-UCP		S-UKP C-UKP			
S(M)-F C(M)-F		S-UCF C-UCF		S-UKF C-UKF			
C(M)-FS		C-UCFS		C-UKFS			
S(M)-FC C(M)-FC		S-UCFC C-UCFC		S-UKFC C-UKFC			
S(M)-FL C(M)-FL		S-UCFL C-UCFL		S-UKFL C-UKFL			
S(M)-T C(M)-T		S-UCT C-UCT		S-UKT C-UKT			
Accessories ⁽¹⁰⁾		MSS	S5W	HRS	GA	GB	GC

(1) Bearing unit - (2) Insert bearing unit - (3) Cast iron bearing units with protective caps - (4) Pressed steel protective cap - (5) Cast iron protective cap - (6) Opened on both side - (7) Closed on one side - (8) S-protective caps (9) C-protective caps - (10) Accessories

(1) Corps de palier - (2) Roulement insert - (3) Corps de paliers en fonte avec bouchons de protection - (4) Bouchons de protection en tôle - (5) Bouchons de protection en fonte - (6) Ouvert des deux côtés - (7) Fermé sur un côté - (8) Bouchons de protection S - (9) Bouchons de protection C - (10) Accessoires

(1) Gehäuse - (2) Einsatz - (3) Gusslager mit Schutzkappen - (4) Schutzkappe aus Blech - (5) Schutzkappe aus Guss - (6) Auf zwei Seiten geöffnet - (7) Auf einer Seite geschlossen - (8) Schutzkappe S - (9) Schutzkappe C - (10) Zubehör

(1) Corpo esterno - (2) Inserti - (3) Supporti in ghisa con copercchi di protezione - (4) Copercchi di protezione in lamiera - (5) Copercchi di protezione in lamiera - (6) Aperto sui due lati - (7) Chiuso su un lato - (8) Copercchi di protezione S - (9) Copercchi di protezione C - (10) Accessori

(1) Cuerpo - (2) Rodamiento inserto - (3) Cuerpos de soporte de fundición con tapas de protección - (4) Tapas de protección de chapa - (5) Tapas de protección de fundición - (6) Abierto en ambos lados - (7) Cerrado en un lado - (8) Tapas de protección S - (9) Tapas de protección C - (10) Accesorios

(1) Corpo - (2) Rolamentos abaulados - (3) Corpos de mancais em fonte com tampas protetoras - (4) Tampas de proteção em chapa - (5) Tampas de proteção em fonte - (6) Aberto dos dois lados - (7) Fechado de um lado - (8) Tampas de proteção S - (9) Tampas de proteção C - (10) Acessórios

(1) Корпус подшипника - (2) Корпусной подшипник - (3) Чугунные корпуса подшипников с торцевыми крышками - (4) Торцевые крышки из штампованной стали - (5) Торцевые крышки из чугуна - (6) Открытый с обеих сторон - (7) Закрытый с одной стороны - (8) Торцевые крышки S - (9) Торцевые крышки C - (10) Комплектующие

(1) Zespół łożyskowy - (2) Łożysko samonastawne - (3) Zespoły łożyskowe z korpusem żeliwnym z pokrywami ochronnymi - (4) Pokrywy ochronne z blachy - (5) Pokrywy ochronne z żeliwa - (6) Otwarte z obu stron - (7) Zamknięte z jednej strony - (8) Pokrywy ochronne S - (9) Pokrywy ochronne C - (10) Akcesoria

**SNR Self-aligning bearing units / Paliers auto-aligneurs SNR / SNR Gehäuselager /
Supporti orientabili SNR / Soportes autoalineantes SNR / Mancais auto-alinháveis /
Самоустанавливающиеся подшипниковые узлы SNR / Samonastawne zespoły łożyskowe SNR**

	Housing ⁽¹⁾	Insert	UC200	UC300	SUC200	MUC200	US200	ES200	SES200	EX200	EX300	UK200+H	UK300+H	Protection caps	
Pillow blocks ⁽²⁾	Cast iron ⁽³⁾	PE	UCPE				USPE	ESPE		EXPE		UKPE+H		CC,CCE/CO,COE	
		PLE	UCPLE				USPLE	ESPLE		EXPLE		UKPLE+H		CC,CCE/CO,COE	
		P	UCP	UCP				USP	ESP		EXP	EXP	UKP+H	UKP+H	CC,CCE/CO,COE
		PH	UCPH					USPH	ESPH		EXPH		UKPH+H		CC,CCE/CO,COE
		PAE	UCPAE					USPAE	ESPAE		EXPAE		UKPAE+H		CC,CCE/CO,COE
		PG	UCPG					USPG	ESPG		EXPG		UKPG+H		CC,CCE/CO,COE
	PA	UCPA					USPA	ESPA		EXPA		UKPA+H		CC,CCE/CO,COE	
	Pressed steel ⁽⁴⁾	PP					USPP	ESPP							
	Stainless steel ⁽⁵⁾	SP			SUCP					SESP					CC,CCE/CO,COE
		SPA			SUCPA					SESPA					CC,CCE/CO,COE
Thermoplastic ⁽⁶⁾	GNP					GNP								CF/CV	
Flanged units ⁽⁷⁾	Cast iron ⁽³⁾	FE	UCFE				USFE	ESFE		EXFE		UKFE+H		CC,CCE/CO,COE	
		F	UCF	UCF			USF	ESF		EXF	EXF	UKF+H	UKF+H	CC,CCE/CO,COE	
		FS		UCFS							EXFS		UKFS+H		
		FCE	UCFCE					USFCE	ESFCE		EXFCE		UKFCE+H		
		FC	UCFC					USFCE	ESFCE		EXFC		UKFC+H		CC,CCE/CO,COE
		FEE						USFEE	ESFEE						
		FTE						USFTE	ESFTE						
		FLE	UCFLE					USFLE	ESFLE		EXFLE		UKFLE+H		CC,CCE/CO,COE
		FL	UCFL	UCFL				USFL	ESFL		EXFL	EXFL	UKFL+H	UKFL+H	CC,CCE/CO,COE
		FLZ	UCFLZ					USFLZ	ESFLZ		EXFLZ		UKFLZ+H		
		FD						USFD	ESFD						
		FAE						USFAE	ESFAE						
	FA	UCFA					USFA	ESFA		EXFA		UKFA+H		CC,CCE/CO,COE	
	Pressed steel ⁽⁴⁾	PF					USPF	ESPF							
		PFL					USPFL	ESPFL							
		PFT					USPFT	ESPFT							
		PFE					USPFE	ESPFE							
	Stainless steel ⁽⁵⁾	SF			SUCF					SESF					CC,CCE/CO,COE
		SFL			SUCFL					SESFL					CC,CCE/CO,COE
	Thermoplastic ⁽⁶⁾	GSF					GSF								CF/CV
GSFT						GSFT								CF/CV	
Take-up, cartridge- and hanger units ⁽⁸⁾	Cast iron ⁽³⁾	T	UCT	UCT			UST	EST		EXT		UKT+H	UKT+H	CC,CCE/CO,COE	
		T+WB	UCT+WB					UST+WB	EST+WB		EXT+WB		UKT+H+WB		CC,CCE/CO,COE
		SP	UCSP					USSP	ESSP		EXSP		UKSP+H		CC,CCE/CO,COE
		C	UCC	UCC				USC	ESC		EXC	EXC	UKC+H	UKC+H	
		EHE	UCEHE					USEHE	ESEHE		EXEHE		UKEHE+H		
	Stainless steel ⁽⁵⁾	ST			SUCT					SEST					CC,CCE/CO,COE

🇬🇧 (1) Housing - (2) Pillow blocks - (3) Cast iron - (4) Pressed steel - (5) Stainless steel - (6) Thermoplastic - (7) Flanged units - (8) Take-up, cartridge- and hanger units

🇫🇷 (1) Corps - (2) Paliers à semelle - (3) Fonte - (4) Tôle - (5) Inox - (6) Thermoplastique - (7) Paliers appliqués - (8) Tendeurs, embouts cartouches

🇩🇪 (1) Gehäuse - (2) Stahlagergehäuse - (3) Guss - (4) Blech - (5) Edelstahl - (6) Thermoplast - (7) Flanschlagergehäuse - (8) Spannplattenlager, Hängelager, Hülsenlagergehäuse

🇮🇹 (1) Corpo esterno - (2) Supporti ritto - (3) Ghisa - (4) Lameria in acciaio - (5) Acciaio inossidabile - (6) Resina termoplastica - (7) Supporti flangiati - (8) Supporti tenditori, di estremità, a cartuccia

🇪🇸 (1) Cuerpo - (2) Soportes zócalo - (3) Fundición - (4) Chapa - (5) Acero inoxidable - (6) Termoplástico - (7) Soportes aplicados - (8) Tensor, extremos cartuchos

🇧🇷 (1) Corpo - (2) Mancais - (3) Ferro fundido - (4) Chapa - (5) Inox - (6) Termoplástico - (7) Mancais flangeados - (8) Tensores, terminais cartuchos

🇷🇺 (1) Корпус - (2) Опорные подшипниковые узлы - (3) Чугун - (4) Штампованная сталь - (5) Нержавеющая сталь - (6) Термопластический - (7) Фланцевые подшипниковые узлы - (8) Натяжители, узлы-картриджи

🇵🇱 (1) Oprawa - (2) Oprawa dzielona - (3) Żeliwo - (4) Blacha - (5) Stal nierdzewna - (6) Tworzywo termoplastyczne - (7) Oprawy kołnierzowe - (8) Oprawy naciągowe, wiszące, typu cartridge

**SNR Self-aligning bearing units / Paliers auto-aligneurs SNR / SNR Gehäuselager /
Supporti orientabili SNR / Soportes autoalineantes SNR / Mancais auto-alinháveis /
Самоустанавливающиеся подшипниковые узлы SNR / Samonastawne zespoły łożyskowe SNR**

UC200	UC300	SUC200	MUC200	US200	ES200	SES200	EX200	EX300	UK200H/ LK200H	UK300H	CS200
PE	PLE	P	PH	PAE	PG	PA	PP	SP	SPA	GNP	
FE	F	FS	FCE	FC	FEE	FTE	FLE	FL	FLZ		
FD	FAE	FA	PF	PFL	PFT	PFE	SF	SFL	GSF	GSFT	
T	T-WB	SP		C	EHE	ST					

**Self-aligning ball bearings / Paliers auto-aligneurs / Gehäuselager /
Supporti orientabili / Soportes autoalineantes / Mancais auto-alinháveis /
Самоустанавливающиеся подшипниковые узлы / Zespoły łożyskowe wahlwe**

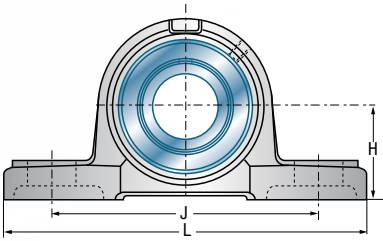

Ø	Reference	Ø K+H	H	L	J	Kg	Brands
12	UCP201		33,3	127	95	0,7	SNR
12	UCP201D1		30,2	127	95	0,7	NTN
12	UCPE201		33,3	130	97	0,5	SNR
15	UCP202		33,3	127	95	0,7	SNR
15	UCP202D1		30,2	127	95	0,7	NTN
15	UCPE202		33,3	130	97	0,5	SNR
17	UCP203		33,3	127	95	0,7	SNR
17	UCP203D1		30,2	127	95	0,7	NTN
17	UCPE203		33,3	130	97	0,5	SNR
20	UCP204		33,3	127	95	0,7	NTN / SNR
20	UCPE204		33,3	130	97	0,5	SNR
25	UCP205	20	36,5	140	105	0,8	NTN / SNR
25	UCPE205	20	36,5	130	103	0,7	SNR
30	UCP206	25	42,9	165	121	1,3	NTN / SNR
30	UCPE206	25	42,9	158	118	1,1	SNR
35	UCP207	30	47,6	167	127	1,4	NTN / SNR
35	UCPE207	30	47,6	163	126	1,5	SNR
40	UCP208	35	49,2	184	137	1,9	NTN / SNR
40	UCPE208	35	49,2	179	138	1,8	SNR
45	UCP209	40	54	190	146	2,2	NTN / SNR
45	UCPE209	40	54	192	150	2,2	SNR
50	UCP210	45	57,2	206	159	2,7	NTN / SNR
50	UCPE210	45	57,2	200	158	2,7	SNR
55	UCP211	50	63,5	219	171	3,2	NTN / SNR
55	UCPE211	50	63,5	222	176	3,4	SNR
60	UCP212	55	69,8	241	184	4,7	NTN / SNR
60	UCPE212	55	69,9	240	190	4,8	SNR
65	UCP213	60	76,2	265	203	5,8	NTN / SNR
65	UCPE213	60	79,4	260	203	6,1	SNR
70	UCP214		79,4	266	210	7,2	NTN / SNR
70	UCPE214		79,4	260	203	6,1	SNR
75	UCP215	65	82,6	275	217	7,6	NTN / SNR
75	UCPE215	65	82,5	265	210	6,9	SNR
80	UCP216	70	88,9	292	232	10	NTN / SNR
80	UCPE216	70	89	290	232	9	SNR
85	UCP217	75	95,2	310	247	10,8	NTN / SNR
90	UCP218	80	101,6	327	262	14	NTN / SNR
90	UCPE218	80	101,6	330	268	13,3	SNR

Ø	Reference	Ø K+H	H	L	J	Kg	Brands
25	UCPX05	20	44,4	159	119	1,5	NTN
30	UCPX06	25	47,6	175	127	2	NTN
35	UCPX07	30	54	203	144	2,6	NTN
40	UCPX08	35	58,7	222	156	3,3	NTN
45	UCPX09	40	58,7	222	156	3,3	NTN
50	UCPX10	45	63,5	241	171	4,3	NTN
55	UCPX11	50	69,8	260	184	5,7	NTN
60	UCPX12	55	76,2	286	203	7,3	NTN
65	UCPX13	60	76,2	286	203	7,6	NTN
70	UCPX14		88,9	330	229	9,9	NTN
75	UCPX15	65	88,9	330	229	11	NTN
80	UCPX16	70	101,6	381	283	15	NTN
85	UCPX17	75	101,6	381	283	16	NTN
90	UCPX18	80	101,6	381	283	17	NTN
100	UCPX20	90	127	432	337	30	NTN

Ø	Reference	Ø K+H	H	L	J	Kg	Brands
25	UCP305	20	45	175	132	1,6	NTN / SNR
30	UCP306	25	50	180	140	1,9	NTN / SNR
35	UCP307	30	56	210	160	2,7	NTN / SNR
40	UCP308	35	60	220	170	3,3	NTN / SNR
45	UCP309	40	67	245	190	4,5	NTN / SNR
50	UCP310	45	75	275	212	6,3	NTN / SNR
55	UCP311	50	80	310	236	7,7	NTN / SNR
60	UCP312	55	85	330	250	9,3	NTN / SNR
65	UCP313	60	90	340	260	10	NTN / SNR
70	UCP314		95	360	280	12	NTN / SNR
75	UCP315	65	100	380	290	15	NTN / SNR
80	UCP316	70	106	400	300	19	NTN / SNR
85	UCP317	75	112	420	320	19	NTN / SNR
90	UCP318	80	118	430	330	24	NTN / SNR
95	UCP319	85	125	470	360	29	NTN / SNR
100	UCP320	90	140	490	380	35	NTN / SNR
105	UCP321		140	490	380	37	NTN / SNR
110	UCP322	100	150	520	400	43	NTN / SNR
120	UCP324	110	160	570	450	54	NTN / SNR
130	UCP326	115	180	600	480	72	NTN / SNR
140	UCP328	125	200	620	500	89	NTN / SNR

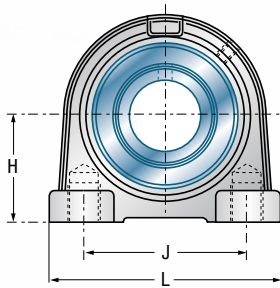

Ø	Reference	Ø K+H	H	L	J	Kg	Brands
12	UCPA201		30,2	76	52	0,6	SNR
12	UCPAE201		33,3	65	50,8	0,5	SNR
12	UCUP201D1		30,2	76	52	0,6	NTN
15	UCPA202		30,2	76	52	0,6	SNR
15	UCPAE202		33,3	65	50,8	0,5	SNR
15	UCUP202D1		30,2	76	52	0,6	NTN
17	UCPA203		30,2	76	52	0,5	SNR
17	UCPAE203		33,3	65	50,8	0,4	SNR
17	UCUP203D1		30,2	76	52	0,6	NTN
20	UCPA204		30,2	76	52	0,5	SNR
20	UCPAE204		33,3	65	50,8	0,5	SNR
20	UCUP204D1		30,2	76	52	0,6	NTN
25	UCPA205	20	36,5	84	56	0,7	SNR
25	UCPAE205	20	36,5	70	50,8	0,6	SNR
25	UCUP205D1	20	36,5	84	56	0,8	NTN
30	UCPA206	25	42,9	94	66	1,1	SNR
30	UCPAE206	25	42,9	98	76,2	1	SNR
30	UCUP206D1	25	42,9	94	66	1,2	NTN
35	UCPA207	30	47,6	110	80	1,5	SNR
35	UCPAE207	30	47,6	103	82,6	1,3	SNR
35	UCUP207D1	30	47,6	110	80	1,7	NTN
40	UCPA208	35	49,2	116	84	1,8	SNR
40	UCPAE208	35	49,2	116	88,9	1,6	SNR
40	UCUP208D1	35	49,2	116	84	2	NTN
45	UCPA209	40	54,2	120	90	2,1	SNR
45	UCPAE209	40	53,9	120	95,3	1,9	SNR
45	UCUP209D1	40	54,2	120	90	2,2	NTN
50	UCPA210	45	57,2	130	94	2,6	SNR
50	UCPAE210	45	57,2	135	101,6	2,5	SNR
50	UCUP210D1	45	57,2	130	94	2,9	NTN
55	UCPA211	50	63,5	140	104	3,2	SNR
55	UCPAE211	50	64	150	118	3,2	SNR
60	UCPA212	55	69,9	150	114	4,1	SNR
60	UCPAE212	55	69,9	150	118	4	SNR

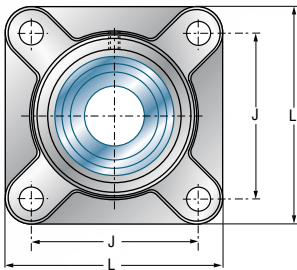

Ø	Reference	Ø K+H	L	J	Kg	Brands
12	UCF201		86	64	0,6	NTN / SNR
12	UCFE201		86	63,5	0,7	SNR
15	UCF202		86	64	0,6	NTN / SNR
15	UCFE202		86	63,5	0,7	SNR
17	UCF203		86	64	0,6	NTN / SNR
17	UCFE203		86	63,5	0,5	SNR
20	UCF204		86	64	0,6	NTN / SNR
20	UCFE204		86	63,5	0,7	SNR
25	UCF205	20	95	70	0,8	NTN / SNR
25	UCFE205	20	95	70	0,8	SNR
30	UCF206	25	108	83	1,1	NTN / SNR
30	UCFE206	25	108	82,5	1,2	SNR
35	UCF207	30	117	92	1,5	NTN / SNR
35	UCFE207	30	118	92	1,6	SNR
40	UCF208	35	130	102	1,8	NTN / SNR
40	UCFE208	35	130	101,5	2,1	SNR
45	UCF209	40	137	105	2,3	NTN / SNR
45	UCFE209	40	137	105	2,2	SNR
50	UCF210	45	143	111	2,6	NTN / SNR
50	UCFE210	45	143	111	2,6	SNR
55	UCF211	50	162	130	3,5	NTN / SNR
55	UCFE211	50	162	130	3,7	SNR
60	UCF212	55	175	143	4,3	NTN / SNR
60	UCFE212	55	175	143	4,9	SNR
65	UCF213	60	187	149	5,7	NTN / SNR
65	UCFE213	60	188	150	6	SNR
70	UCF214		193	152	6,1	NTN / SNR
70	UCFE214		188	150	6,2	SNR
75	UCF215	65	200	159	6,9	NTN / SNR
75	UCFE215	65	197	153	6,3	SNR
80	UCF216	70	208	165	7,8	NTN / SNR
80	UCFE216	70	197	153	7,1	SNR
85	UCF217	75	220	175	9,2	NTN / SNR
90	UCF218	80	235	187	11	NTN / SNR
90	UCFE218	80	235	187	10,4	SNR

Ø	Reference	Ø K+H	L	J	Kg	Brands
25	UCFX05	20	108	83	1	NTN
30	UCFX06	25	117	92	1,7	NTN
35	UCFX07	30	130	102	2,1	NTN
40	UCFX08	35	137	105	2,4	NTN
45	UCFX09	40	143	111	2,5	NTN
50	UCFX10	45	162	130	3,9	NTN
55	UCFX11	50	175	143	4,9	NTN
60	UCFX12	55	187	149	5,2	NTN
65	UCFX13	60	187	149	5,3	NTN
70	UCFX14		197	152	7,3	NTN
75	UCFX15	65	197	152	8,1	NTN
80	UCFX16	70	214	171	9,9	NTN
85	UCFX17	75	214	171	11	NTN
90	UCFX18	80	214	171	11	NTN
100	UCFX20	90	268	211	17	NTN

Ø	Reference	Ø K+H	L	J	Kg	Brands
25	UCF305	20	110	80	1,2	NTN / SNR
30	UCF306	25	125	95	1,7	NTN / SNR
35	UCF307	30	135	100	2,1	NTN / SNR
40	UCF308	35	150	112	2,7	NTN / SNR
45	UCF309	40	160	125	3,6	NTN / SNR
50	UCF310	45	175	132	4,7	NTN / SNR
55	UCF311	50	185	140	5,8	NTN / SNR
60	UCF312	55	195	150	6,7	NTN / SNR
65	UCF313	60	208	166	8,3	NTN / SNR
70	UCF314		226	178	10	NTN / SNR
75	UCF315	65	236	184	12	NTN / SNR
80	UCF316	70	250	196	13	NTN / SNR
85	UCF317	75	260	204	16	NTN / SNR
90	UCF318	80	280	216	20	NTN / SNR
95	UCF319	85	290	228	22	NTN / SNR
100	UCF320	90	310	242	26	NTN / SNR
105	UCF321		310	242	27	NTN / SNR
110	UCF322	100	340	266	37	NTN / SNR
120	UCF324	110	370	290	48	NTN / SNR
130	UCF326	115	410	320	65	NTN / SNR
140	UCF328	125	450	350	89	NTN / SNR



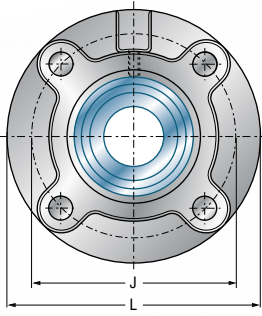

Ø	Reference	Ø K+H	L	J	Kg	Brands
12	UCFC201		100	78	0,7	NTN / SNR
12	UCFCE201		100	78	0,6	SNR
15	UCFC202		100	78	0,7	NTN / SNR
15	UCFCE202		100	78	0,6	SNR
17	UCFC203		100	78	0,6	NTN / SNR
17	UCFCE203		100	78	0,6	SNR
20	UCFC204		100	78	0,6	NTN / SNR
20	UCFCE204		100	78	0,5	SNR
25	UCFC205	20	115	90	1	NTN / SNR
25	UCFCE205	20	115	90	0,8	SNR
30	UCFC206	25	125	100	1,3	NTN / SNR
30	UCFCE206	25	125	100	1	SNR
35	UCFC207	30	135	110	1,7	NTN / SNR
35	UCFCE207	30	135	110	1,2	SNR
40	UCFC208	35	145	120	2	NTN / SNR
40	UCFCE208	35	145	120	1,6	SNR
45	UCFC209	40	160	132	2,5	NTN / SNR
45	UCFCE209	40	155	130	1,9	SNR
50	UCFC210	45	165	138	2,9	NTN / SNR
50	UCFCE210	45	165	135	2,2	SNR
55	UCFC211	50	185	150	3,9	NTN / SNR
55	UCFCE211	50	185	150	3,1	SNR
60	UCFC212	55	195	160	5	NTN / SNR
60	UCFCE212	55	195	160	3,9	SNR
65	UCFC213	60	205	170	5,5	NTN / SNR
65	UCFCE213	60	215	177	4,9	SNR
70	UCFC214		215	177	6,4	NTN / SNR
70	UCFCE214		215	177	5,1	SNR
75	UCFC215	65	220	184	7,2	NTN / SNR
75	UCFCE215	65	220	184	5,5	SNR
80	UCFC216	70	240	200	9	NTN / SNR
80	UCFCE216	70	220	184	5,6	SNR
85	UCFC217	75	250	208	10,6	NTN / SNR
90	UCFC218	80	265	220	13,2	NTN / SNR
90	UCFCE218	80	265	220	9,6	SNR

Ø	Reference	Ø K+H	L	J	Kg	Brands
25	UCFCX05	20	111	92	1,1	NTN
30	UCFCX06	25	127	105	1,6	NTN
35	UCFCX07	30	133	111	2	NTN
40	UCFCX08	35	133	111	1,9	NTN
45	UCFCX09	40	155	130	2,7	NTN
50	UCFCX10	45	162	136	3,2	NTN
55	UCFCX11	50	180	152	4,4	NTN
60	UCFCX12	55	194	165	5,7	NTN
65	UCFCX13	60	194	165	5,7	NTN
70	UCFCX14		222	190	7,3	NTN
75	UCFCX15	65	222	190	7,7	NTN
80	UCFCX16	70	260	219	11	NTN
85	UCFCX17	75	260	219	12	NTN
90	UCFCX18	80	260	219	12	NTN
100	UCFCX18	90	276	238	16	NTN

Ø	Reference	Ø K+H	L	J	Kg	Brands
25	UCFS305	20	110	80	1,3	NTN / SNR
30	UCFS306	25	125	95	1,9	NTN / SNR
35	UCFS307	30	135	100	2,4	NTN / SNR
40	UCFS308	35	150	112	3,3	NTN / SNR
45	UCFS309	40	160	125	4	NTN / SNR
50	UCFS310	45	175	132	5,3	NTN / SNR
55	UCFS311	50	185	140	6,2	NTN / SNR
60	UCFS312	55	195	150	7,2	NTN / SNR
65	UCFS313	60	208	166	8,9	NTN / SNR
70	UCFS314		226	178	11	NTN / SNR
75	UCFS315	65	236	184	13	NTN / SNR
80	UCFS316	70	250	196	15	NTN / SNR
85	UCFS317	75	260	204	17	NTN / SNR
90	UCFS318	80	280	216	21	NTN / SNR
95	UCFS319	85	290	228	25	NTN / SNR
100	UCFS320	90	310	242	30	NTN / SNR
105	UCFS321		310	242	29	NTN / SNR
110	UCFS322	100	340	266	39	NTN / SNR
120	UCFS324	110	370	290	54	NTN / SNR
130	UCFS326	115	410	320	71	NTN / SNR
140	UCFS328	125	450	350	100	NTN / SNR

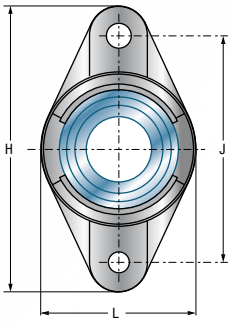

Ø	Reference	Ø K+H	H	L	J	Kg	Brands
12	UCFL201		113	90	60	0,5	NTN / SNR
12	UCFLE201		112	90	61	0,5	SNR
15	UCFL202		113	90	60	0,5	NTN / SNR
15	UCFLE202		112	90	61	0,5	SNR
17	UCFL203		113	90	60	0,4	NTN / SNR
17	UCFLE203		112	90	61	0,5	SNR
20	UCFL204		113	90	60	0,4	NTN / SNR
20	UCFLE204		112	90	61	0,5	SNR
25	UCFL205	20	130	99	68	0,6	NTN / SNR
25	UCFLE205	20	124	99	70	0,6	SNR
30	UCFL206	25	148	117	80	0,9	NTN / SNR
30	UCFLE206	25	142	116,5	80	0,8	SNR
	UCFL207	30	161	130	90	1,2	NTN / SNR
35	UCFLE207	30	155	130	92	1,1	SNR
40	UCFL208	35	175	144	100	1,5	NTN / SNR
40	UCFLE208	35	172	143,5	105	1,6	SNR
45	UCFL209	40	188	148	108	1,9	NTN / SNR
45	UCFLE209	40	180	148,5	111	1,8	SNR
50	UCFL210	45	197	157	115	2,2	NTN / SNR
50	UCFLE210	45	190	157	116	2,1	SNR
55	UCFL211	50	224	184	130	3	NTN / SNR
55	UCFLE211	50	222	184	134	3,4	SNR
60	UCFL212	55	250	202	140	3,9	NTN / SNR
60	UCFLE212	55	238	202	138	3,7	SNR
65	UCFL213	60	258	210	155	4,8	NTN / SNR
65	UCFLE213	60	258	216	160	4	SNR
70	UCFL214		265	216	160	5,4	NTN / SNR
70	UCFLE214		258	216	160	5,4	SNR
75	UCFL215	65	275	225	164	5,4	NTN / SNR
75	UCFLE215	65	258	216	160	5,2	SNR
80	UCFL216	70	290	233	180	7,1	NTN / SNR
85	UCFL217	75	305	248	190	8,5	NTN / SNR
90	UCFL218	80	320	265	205	10,9	NTN / SNR

Ø	Reference	Ø K+H	H	L	J	Kg	Brands
25	UCFLX05	20	141	83	117	1	NTN
30	UCFLX06	25	156	95	130	1,5	NTN
35	UCFLX07	30	171	105	144	2	NTN
40	UCFLX08	35	179	111	148	2,2	NTN
45	UCFLX09	40	189	116	157	2,4	NTN
50	UCFLX10	45	216	133	184	3,4	NTN

Ø	Reference	Ø K+H	H	L	J	Kg	Brands
25	UCFL305	20	150	113	80	0,9	NTN / SNR
30	UCFL306	25	180	134	90	1,4	NTN / SNR
35	UCFL307	30	185	141	100	1,7	NTN / SNR
40	UCFL308	35	200	158	112	2,2	NTN / SNR
45	UCFL309	40	230	177	125	3,1	NTN / SNR
50	UCFL310	45	240	187	140	4	NTN / SNR
55	UCFL311	50	250	198	150	4,6	NTN / SNR
60	UCFL312	55	270	212	160	5,8	NTN / SNR
65	UCFL313	60	295	240	175	7,3	NTN / SNR
70	UCFL314		315	250	185	8,7	NTN / SNR
75	UCFL315	65	320	260	195	9,5	NTN / SNR
80	UCFL316	70	355	285	210	12,5	NTN / SNR
85	UCFL317	75	370	300	220	14,4	NTN / SNR
90	UCFL318	80	385	315	235	17	NTN / SNR
95	UCFL319	85	405	330	250	21,3	NTN / SNR
100	UCFL320	90	440	360	270	26,1	NTN / SNR
105	UCFL321		440	360	270	25	NTN / SNR
110	UCFL322	100	470	390	300	32,6	NTN / SNR
120	UCFL324	110	520	430	330	45	NTN / SNR
130	UCFL326	115	550	460	360	56,4	NTN / SNR
140	UCFL328	125	600	500	400	77,6	NTN / SNR



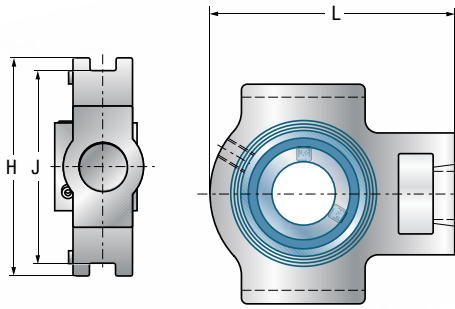

Ø	Reference	Ø K+H	H	L	J	Kg	Brands
12	UCT201		61	12	76	0,8	NTN / SNR
15	UCT202		61	12	76	0,8	NTN / SNR
17	UCT203		61	12	76	0,7	NTN / SNR
20	UCT204		61	12	76	0,7	NTN / SNR
25	UCT205	20	62	12	76	0,8	NTN / SNR
30	UCT206	25	70	12	89	1,2	NTN / SNR
35	UCT207	30	78	12	89	1,6	NTN / SNR
40	UCT208	35	88	16	102	2,3	NTN / SNR
45	UCT209	40	87	16	102	2,3	SNR
45	UCT209D1	40	88	16	102	2,3	NTN
50	UCT210	45	90	16	102	2,5	SNR
50	UCT210D1	45	92	16	102	2,5	NTN
55	UCT211	50	106	22	130	3,9	NTN / SNR
60	UCT212	55	119	22	130	4,7	NTN / SNR
65	UCT213	60	137	26	151	6,8	NTN / SNR
70	UCT214		137	26	151	6,9	NTN / SNR
75	UCT215	65	140	26	151	7,2	NTN / SNR
80	UCT216	70	140	26	165	8,2	NTN / SNR
85	UCT217	75	162	30	173	10,8	NTN / SNR

Ø	Reference	Ø K+H	H	L	J	Kg	Brands
25	UCTX05	20	70	12	89	1,4	NTN
30	UCTX06	25	78	12	89	1,8	NTN
35	UCTX07	30	88	16	102	2,6	NTN
40	UCTX08	35	87	16	102	2,6	NTN
45	UCTX09	40	92	16	102	2,8	NTN
50	UCTX10	45	106	22	130	4,3	NTN
55	UCTX11	50	119	22	130	5,2	NTN
60	UCTX12	55	137	26	151	7,6	NTN
65	UCTX13	60	137	26	151	7,6	NTN
70	UCTX14		140	26	151	7,7	NTN
75	UCTX15	65	140	28	165	8,4	NTN
80	UCTX16	70	162	28	173	11	NTN
85	UCTX17	75	162	28	173	12	NTN

Ø	Reference	Ø K+H	H	L	J	Kg	Brands
25	UCT305	20	76	12	80	1,3	NTN / SNR
30	UCT306	25	85	16	90	1,8	NTN / SNR
35	UCT307	30	94	16	100	2,3	NTN / SNR
40	UCT308	35	100	18	112	3	NTN / SNR
45	UCT309	40	110	18	125	4	NTN / SNR
50	UCT310	45	118	20	140	4	NTN / SNR
55	UCT311	50	127	22	150	6,1	NTN / SNR
60	UCT312	55	135	22	160	7,6	NTN / SNR
65	UCT313	60	146	26	170	9,5	NTN / SNR
70	UCT314		155	26	180	11,1	NTN / SNR
75	UCT315	65	160	26	192	12,5	NTN / SNR
80	UCT316	70	174	30	204	16	NTN / SNR
85	UCT317	75	183	32	214	18,9	NTN / SNR
90	UCT318	80	192	32	228	21,5	NTN / SNR
95	UCT319	85	197	35	240	25,9	NTN / SNR
100	UCT320	90	210	35	260	30,6	NTN / SNR
105	UCT321		212	35	260	31,6	NTN / SNR
110	UCT322	100	235	38	285	38,6	NTN / SNR
120	UCT324	110	267	45	320	53,9	NTN / SNR
130	UCT326	115	285	50	350	67,8	NTN / SNR
140	UCT328	125	315	50	380	83,2	NTN / SNR

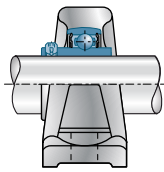
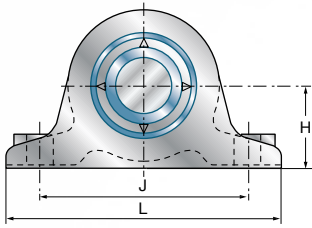

Ø	Reference	Ø K+H	H	L	J	Kg	Brands
40	UCIP208	35	60	200	150	3,5	NTN
45	UCIP209	40	70	210	160	3,8	NTN
50	UCIP210	45	70	220	170	4,4	NTN
55	UCIP211	50	80	230	180	5,5	NTN
60	UCIP212	55	80	260	200	6	NTN
65	UCIP213	60	90	280	220	7,6	NTN
65	UCIP313	60	110	310	250	13	NTN
70	UCIP314		110	330	270	15	NTN
75	UCIP315	65	120	340	280	16	NTN
80	UCIP316	70	120	350	290	21	NTN
85	UCIP317	75	130	370	310	23	NTN
90	UCIP318	80	130	400	330	26	NTN
95	UCIP319	85	150	410	340	30	NTN
100	UCIP320	90	150	430	360	34	NTN
110	UCIP322	100	170	490	410	51	NTN
120	UCIP324	110	170	510	430	57	NTN
130	UCIP326	115	200	550	470	74	NTN
140	UCIP328	125	200	590	500	84	NTN



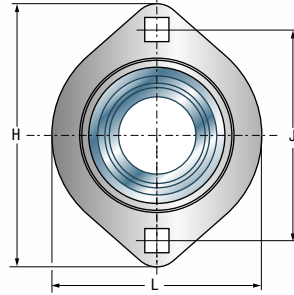
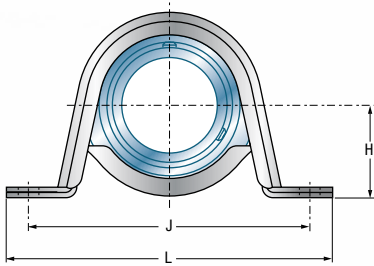

Ø	Reference	H	L	J	Kg	Brands
12	ASPP201	22,2	86	68	0,2	NTN
12	USPP201	22,2	85,7	68	0,2	SNR
15	ASPP202	22,2	86	68	0,2	NTN
15	USPP202	22,2	85,7	68	0,2	SNR
17	ASPP203	22,2	86	68	0,2	NTN
17	USPP203	22,2	85,7	68	0,2	SNR
20	ASPP204	25,4	98	76	0,2	NTN
20	USPP204	25,4	98,4	76	0,2	SNR
25	ASPP205	28,6	108	86	0,3	NTN
25	USPP205	28,6	108	86	0,4	SNR
30	ASPP206	33,3	117	95	0,4	NTN
30	USPP206	33,3	117,5	95	0,6	SNR
35	ASPP207	39,7	129	106	0,6	NTN
35	USPP207	39,7	128,6	106	0,9	SNR

Ø	Reference	H	J	L	Kg	Brands
12	ASPFL201	81	63,5	59	0,2	NTN
12	USPFL201	81	63,5	58,7	0,2	SNR
15	ASPFL202	81	63,5	59	0,2	NTN
15	USPFL202	81	63,5	58,7	0,2	SNR
17	ASPFL203	81	63,5	59	0,2	NTN
17	USPFL203	81	63,5	58,7	0,2	SNR
20	ASPFL204	90	71,5	67	0,2	NTN
20	USPFL204	90,5	71,5	66,7	0,2	SNR
25	ASPFL205	95	76	71	0,3	NTN
25	USPFL205	95,2	76,2	71	0,4	SNR
30	ASPFL206	113	90,5	84	0,4	NTN
30	USPFL206	112,7	90,5	84	0,6	SNR
35	ASPFL207	122	100	94	0,6	NTN
35	USPFL207	123	100	93,7	0,9	SNR
40	ASPFL208	148	119	100	0,9	NTN
40	USPFL208	151	119	100	1,1	SNR

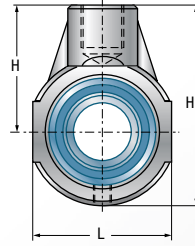
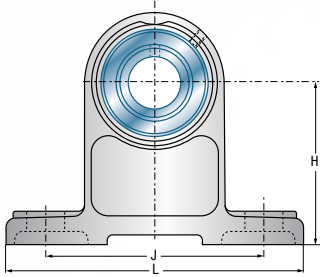

Ø	Reference	Ø K+H	H	L	J	Kg	Brands
12	UCHP201		70	127	95	1	NTN
12	UCPH201		70	127	95	0,9	SNR
15	UCHP202		70	127	95	1	NTN
15	UCPH202		70	127	95	0,9	SNR
17	UCHP203		70	127	95	1	NTN
17	UCPH203		70	127	95	0,8	SNR
20	UCHP204		70	127	95	1	NTN
20	UCPH204		70	127	95	0,9	SNR
25	UCHP205	20	80	142	105	1,3	NTN
25	UCPH205	20	80	140	105	1,2	SNR
30	UCHP206	25	90	165	120	2	NTN
30	UCPH206	25	90	165	121	1,7	SNR
35	UCHP207	30	95	166	127	2,4	NTN
35	UCPH207	30	95	167	127	2,2	SNR
40	UCHP208	35	100	184	136	3,4	NTN
40	UCPH208	35	100	184	137	2,8	SNR
45	UCHP209	40	105	190	146	3,7	NTN
45	UCPH209	40	105	190	146	3,1	SNR
50	UCHP210	45	110	206	159	4,1	NTN
50	UCPH210	45	110	206	159	3,6	SNR

Ø	Reference	L	H1	H	Kg	Brands
12	UCEHE201	65	91	58	0,8	SNR
12	UCHB201D1	64	96	64	0,7	NTN
15	UCEHE202	65	91	58	0,8	SNR
15	UCHB202D1	64	96	64	0,7	NTN
17	UCEHE203	65	91	58	0,5	SNR
17	UCHB203D1	64	96	64	0,7	NTN
20	UCEHE204	65	91	58	0,7	SNR
20	UCHB204D1	64	96	64	0,7	NTN
25	UCEHE205	70	99	64	1,2	SNR
25	UCHB205D1	78	103	64	1	NTN
30	UCEHE206	85	114	72	1,3	SNR
30	UCHB206D1	78	103	64	1	NTN
35	UCEHE207	90	122	76	1,6	SNR
35	UCHB207D1	92	116	70	1,4	NTN
40	UCEHE208	100	135	85	1,8	SNR
40	UCHB208D1	96	121	73	1,5	NTN
45	UCEHE209	110	145	90	1,9	SNR
45	UCHB209D1	108	136	82	2,1	NTN
50	UCEHE210	110	145	90	2	SNR
50	UCHB210D1	118	142	83	2,6	NTN
55	UCHB211D1	126	158	95	2,9	NTN
60	UCHB212D1	142	173	102	4,4	NTN
65	UCHB213D1	166	200	117	6,6	NTN



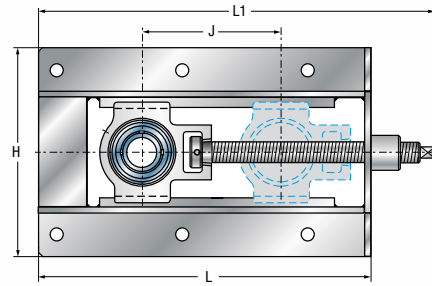
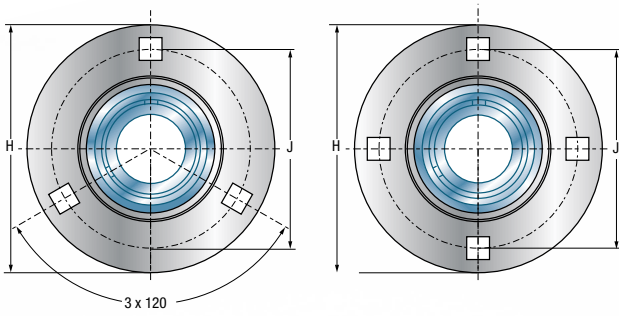

Ø	Reference	H	J	Kg	Brands
12	ASPF201	81	63,5	0,2	NTN
12	USPF201	81	63,5	0,2	SNR
15	ASPF202	81	63,5	0,2	NTN
15	USPF202	81	63,5	0,2	SNR
17	ASPF203	81	63,5	0,2	NTN
17	USPF203	81	63,5	0,2	SNR
20	ASPF204	90	71,5	0,3	NTN
20	USPF204	90,5	71,5	0,3	SNR
25	ASPF205	95	76	0,4	NTN
25	USPF205	95,2	76	0,4	SNR
30	ASPF206	113	90,5	0,5	NTN
30	USPF206	112,7	90,5	0,7	SNR
35	ASPF207	122	100	0,7	NTN
35	USPF207	122,2	100	0,9	SNR
40	ASPF208	148	119	1	NTN
40	USPF208	147,8	119	1,5	SNR
45	USPF209	149,2	120,5	1,7	SNR
50	USPF210	155,6	127	1,8	SNR
55	USPF211	166,6	138	2,2	SNR
60	USPF212	176,2	147,6	2,4	SNR

Ø	Reference	L	H	J	L1	Kg	Brands
12	UCT201-15D1	317	199	150	370	6,4	NTN
12	UCT201+WB	317	199	150	367	5,2	SNR
15	UCT202-15D1	317	199	150	370	6,3	NTN
15	UCT202+WB	317	199	150	367	5,2	SNR
17	UCT203-15D1	317	199	150	370	6,3	NTN
17	UCT203+WB	317	199	150	367	5,2	SNR
20	UCT204-15D1	317	199	150	370	6,3	NTN
20	UCT204+WB	317	199	150	367	5,2	SNR
25	UCT205-15D1	317	199	150	370	6,5	NTN
25	UCT205+WB	317	199	150	368	5,2	SNR
30	UCT206-15D1	337	212	150	393	7,6	NTN
30	UCT206+WB	337	212	150	396	6,2	SNR
35	UCT207-23D1	429	212	230	485	9,2	NTN
35	UCT207+WB	429	212	230	490	8,4	SNR
40	UCT208-30D1	520	233	300	596	13	NTN
40	UCT208+WB	520	233	300	591	11,7	SNR
45	UCT209-30D1	520	233	300	596	16	NTN
45	UCT209+WB	520	233	300	590	11,8	SNR
50	UCT210-30D1	524	233	300	599	16	NTN
50	UCT210+WB	520	233	300	593	12	SNR
55	UCT211-30D1	542	285	300	630	22	NTN
55	UCT211+WB	542	301	300	631	18,4	SNR
60	UCT212-30D1	568	285	300	657	25	NTN
60	UCT212+WB	568	301	300	651	20,2	SNR
65	UCT213-30D1	606	306	300	705	33	NTN
65	UCT213+WB	606	322	300	699	25,3	SNR

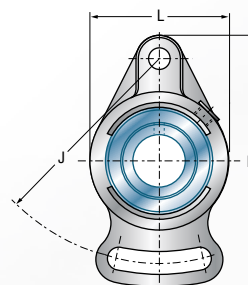
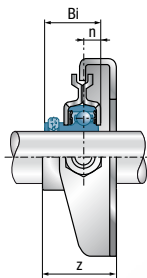
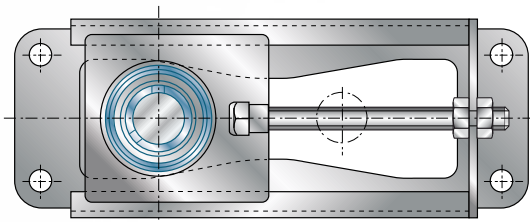

Ø	Reference	z	Bi	n	COURSE	Kg	Brands
12	ASPT201-10	31	22	6	100	1	NTN
15	ASPT202-10	31	22	6	100	1	NTN
17	ASPT203-10	31	22	6	100	1	NTN
20	ASPT204-10	33	25	7	100	1	NTN
25	ASPT205-10	34,5	27	7,5	100	1,1	NTN

Ø	Reference	z	Bi	n	COURSE	Kg	Brands
12	AELPT201-10	37,1	28,6	6,5	100	1	NTN
15	AELPT202-10	37,1	28,6	6,5	100	1	NTN
17	AELPT203-10	37,1	28,6	6,5	100	1	NTN
20	AELPT204-10	38,5	31	7,5	100	1,1	NTN
25	AELPT205-10	38,5	31	7,5	100	1,1	NTN

Ø	Reference	Ø K+H	H	J	L	Kg	Brands
12	UCFA201D1		98	78	60	0,7	NTN
12	UCFA201		102	78	60	0,5	SNR
15	UCFA202D1		98	78	60	0,6	NTN
15	UCFA202		102	78	60	0,6	SNR
17	UCFA203D1		98	78	60	0,6	NTN
17	UCFA203		102	78	60	0,5	SNR
20	UCFA204D1		98	78	60	0,6	NTN
20	UCFA204		102	78	60	0,5	SNR
25	UCFA205D1	20	124	96	70	0,8	NTN
25	UCFA205	20	125	98	68	0,7	SNR
30	UCFA206D1	25	141	115	80	1,2	NTN
30	UCFA206	25	144	117	80	1,2	SNR
35	UCFA207D1	30	155	128	90	1,5	NTN
35	UCFA207	30	161	130	90	1,6	SNR
40	UCFA208D1	35	171	142	100	1,8	NTN
40	UCFA208	35	175	144	100	2	SNR
45	UCFA209D1	40	179	146	110	2,2	NTN
45	UCFA209	40	181	148	108	2,3	SNR
50	UCFA210D1	45	189	155	115	2,6	NTN
50	UCFA210	45	190	157	115	2,7	SNR
55	UCFA211D1	50	216	182	130	3,6	NTN
55	UCFA211	50	219	184	130	3,5	SNR
60	UCFA212	55	250	202	140	4,2	SNR



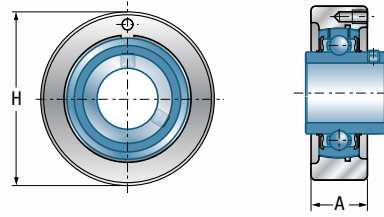
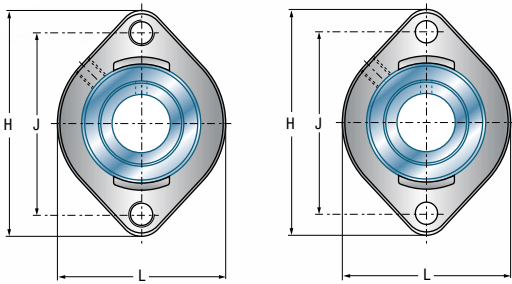

Ø	Reference	H	J	L	Kg	Brands
12	ASFD201	81	63	59	0,3	NTN
12	USFD201	81	63,5	58,7	0,3	SNR
15	ASFD202	81	63	59	0,3	NTN
15	USFD202	81	63,5	58,7	0,3	SNR
17	ASFD203	81	63	59	0,3	NTN
17	USFD203	81	63,5	58,7	0,3	SNR
20	ASFD204	90	71	67	0,4	NTN
20	USFD204	90,5	71,4	66,5	0,4	SNR
25	ASFD205	95	76	71	0,5	NTN
25	USFD205	97	76,2	71	0,5	SNR
30	ASFD206	113	90	84	0,8	NTN
30	USFD206	112,5	90,5	84	0,7	SNR
35	ASFD207	125	100	94	0,9	NTN
35	USFD207	126	100	94	1	SNR
40	USFD208	148	119	104	1,3	SNR

Ø	Reference	Ø K+H	H	A	Kg	Brands
12	UCC201		72	20	0,5	NTN / SNR
15	UCC202		72	20	0,5	NTN / SNR
17	UCC203		72	20	0,5	NTN / SNR
20	UCC204		72	20	0,5	NTN / SNR
25	UCC205	20	80	22	0,7	NTN / SNR
30	UCC206	25	85	27	1	NTN / SNR
35	UCC207	30	90	28	1,1	NTN / SNR
40	UCC208	35	100	30	1,3	NTN / SNR
45	UCC209	40	110	31	1,5	NTN / SNR
50	UCC210	45	120	33	1,9	NTN / SNR
55	UCC211	50	125	35	2,3	NTN / SNR
60	UCC212	55	130	38	2,7	NTN / SNR
65	UCC213	60	140	40	3,2	NTN / SNR
70	UCC214		150	44	5,3	SNR
75	UCC215	65	160	44	5,6	SNR
80	UCC216	70	170	48	6,4	SNR

Ø	Reference	Ø K+H	H	A	Kg	Brands
25	UCC305	20	90	26	1,4	NTN / SNR
30	UCC306	25	100	28	1,7	NTN / SNR
35	UCC307	30	110	32	1,7	NTN / SNR
40	UCC308	35	120	34	2,1	NTN / SNR
45	UCC309	40	130	38	2,9	NTN / SNR
50	UCC310	45	140	40	3,3	NTN / SNR
55	UCC311	50	150	44	3,9	NTN / SNR
60	UCC312	55	160	46	4,7	NTN / SNR
65	UCC313	60	170	50	5,7	NTN / SNR
70	UCC314		180	52	8	NTN / SNR
75	UCC315	65	190	55	8,3	NTN / SNR
80	UCC316	70	200	60	9,6	NTN / SNR
85	UCC317	75	215	64	11,3	NTN / SNR
90	UCC318	80	225	66	12,9	NTN / SNR
95	UCC319	85	240	72	15,9	NTN / SNR
100	UCC320	90	260	75	19,2	NTN / SNR
105	UCC321		260	75	20,2	NTN / SNR
110	UCC322	100	300	80	28,3	NTN / SNR
120	UCC324	110	320	90	33,5	NTN / SNR
130	UCC326	115	340	100	39	NTN / SNR
140	UCC328	125	360	100	45,5	NTN / SNR

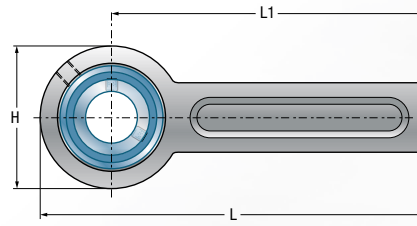
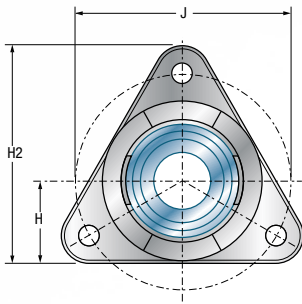

Ø	Reference	H	J	H2	Kg	Brands
12	USFTE201	31	76,1	81	0,4	SNR
15	USFTE202	31	76,1	81	0,4	SNR
17	USFTE203	31	76,1	81	0,4	SNR
20	USFTE204	35	89,5	92	0,6	SNR
25	USFTE205	36	96	97	0,6	SNR
30	USFTE206	44	116	117	1	SNR
35	USFTE207	48	129,7	128	1,4	SNR
40	USFTE208	51	140	137	1,7	SNR
45	USFTE209	55	160	150	2,1	SNR
50	USFTE210	55	160	150	2	SNR

Ø	Reference	L	H	L1	Kg	Brands
12	UCSP201	264	78	225	1,7	SNR
15	UCSP202	264	78	225	1,7	SNR
17	UCSP203	264	78	225	1,7	SNR
20	UCSP204	264	78	225	1,7	SNR
25	UCSP205	264	78	225	1,7	SNR
30	UCSP206	274	98	225	2,1	SNR
35	UCSP207	274	98	225	2,1	SNR
40	UCSP208	320	120	260	4,2	SNR
45	UCSP209	320	120	260	4,2	SNR
50	UCSP210	320	120	260	4,2	SNR



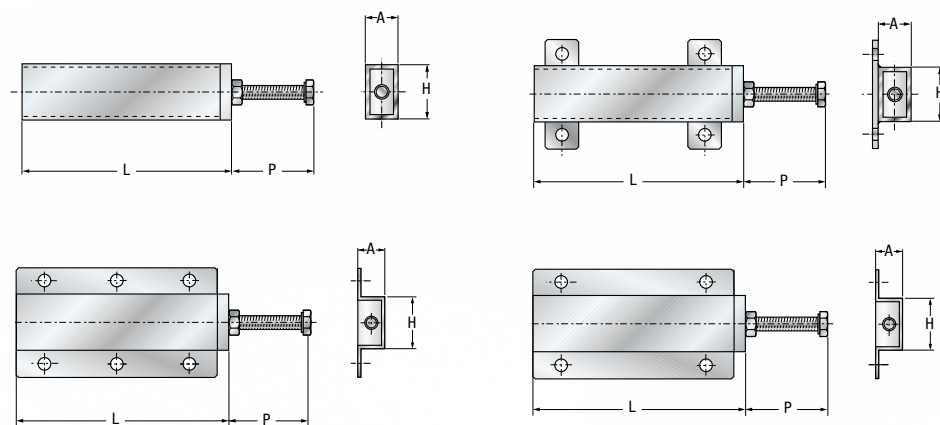

Reference	L	H	A	Kg _{max}	Brands
SPR1	190	50	30	85	SNR
SPR2	225	70	40	105	SNR
SPR11	190	50	30	85	SNR
SPR21	225	70	40	105	SNR
SPR12	190	48	25	85	SNR
SPR22	225	68	35	105	SNR
SPR14	190	48	25	97	SNR
SPR24	235	68	35	111	SNR

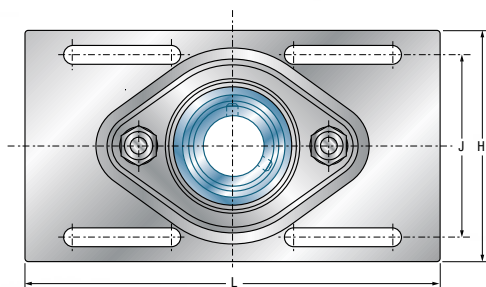

Ø	Reference	L	H	J	Kg	Brands
25	USPFE205	203,2	104,8	80,2	0,6	SNR
30	USPFE206	203,2	114,3	89,2	0,8	SNR

Insert bearings / Roulements inserts / Lagereinsätze / Inserti / Rodamientos insertos / Rolamentos abaulados / Корпусные подшипники / Łożyska samonastawne

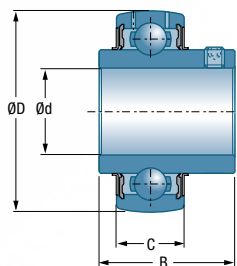

Ø d	Reference	D	B	C	Kg	Brands
12	UC201D1	47	31	17	0,21	NTN
12	UC201G2	47	31	16	0,21	SNR
15	UC202D1	47	31	17	0,2	NTN
15	UC202G2	47	31	16	0,2	SNR
17	UC203D1	47	31	17	0,18	NTN
17	UC203G2	47	31	16	0,18	SNR
20	UC204D1	47	31	17	0,17	NTN
20	UC204G2	47	31	16	0,17	SNR
25	UC205D1	52	34,1	17	0,2	NTN
25	UC205G2	52	34	17	0,21	SNR
30	UC206	62	38,1	19	0,33	NTN / SNR
35	UC207	72	42,9	20	0,49	NTN / SNR
40	UC208	80	49,2	21	0,65	NTN / SNR
45	UC209	85	49,2	22	0,7	NTN / SNR
50	UC210D1	90	51,6	24	0,8	NTN
50	UC210G2	90	51,6	23	0,8	SNR
55	UC211	100	55,6	25	1,08	NTN / SNR
60	UC212	110	65,1	27	1,53	NTN / SNR
65	UC213D1	120	65,1	32	1,85	NTN
65	UC213G2	120	65,1	28	1,86	SNR
70	UC214D1	125	74,6	33	2,1	NTN
70	UC214G2	125	74,6	30	2,05	SNR
75	UC215D1	130	77,8	34	2,35	NTN
75	UC215G2	130	77,8	30	2,21	SNR
80	UC216D1	140	82,6	35	2,8	NTN
80	UC216G2	140	82,6	33	2,79	SNR
85	UC217D1	150	85,7	36	3,37	NTN
85	UC217G2	150	85,7	35	3,38	SNR
90	UC218	160	96	37	4,36	NTN / SNR

Ø d	Reference	D	B	C	Kg	Brands
25	UCX05	62	38,1	19	0,39	NTN
30	UCX06	72	42,9	20	0,68	NTN
35	UCX07	80	49,2	21	0,82	NTN
40	UCX08	85	49,2	22	0,93	NTN
45	UCX09	90	51,6	24	1	NTN
50	UCX10	100	55,6	25	1,35	NTN
55	UCX11	110	65,1	27	1,9	NTN
60	UCX12	120	65,1	32	2,27	NTN
65	UCX13	125	74,6	33	2,45	NTN
70	UCX14	130	77,8	34	2,47	NTN
75	UCX15	140	82,6	35	3,11	NTN
80	UCX16	150	85,7	36	3,79	NTN
85	UCX17	160	96	37	4,82	NTN
90	UCX18	170	104	39	5,51	NTN
100	UCX20	190	117,5	44	8,95	NTN

Ø d	Reference	D	B	C	Kg	Brands
25	UC305D1	62	38	20	0,35	NTN
25	UC305G2	62	38	21	0,35	SNR
30	UC306D1	72	43	23	0,56	NTN
30	UC306G2	72	43	24	0,56	SNR
35	UC307	80	48	25	0,71	NTN / SNR
40	UC308D1	90	52	27	0,96	NTN
40	UC308G2	90	52	28	0,96	SNR
45	UC309D1	100	57	29	1,28	NTN
45	UC309G2	100	57	30	1,28	SNR
50	UC310	110	61	32	1,65	NTN / SNR
55	UC311	120	66	34	2,07	NTN / SNR
60	UC312	130	71	36	2,6	NTN / SNR
65	UC313D1	140	75	39	3,25	NTN
65	UC313G2	140	75	38	3,25	SNR
70	UC314D1	150	78	41	3,89	NTN
70	UC314G2	150	78	40	3,95	SNR
75	UC315D1	160	82	43	4,72	NTN
75	UC315G2	160	82	42	4,33	SNR
80	UC316D1	170	86	45	5,55	NTN
80	UC316G2	170	86	44	5,57	SNR
85	UC317D1	180	96	47	6,67	NTN
85	UC317G2	180	96	46	6,84	SNR
90	UC318D1	190	96	49	7,56	NTN
90	UC318G2	190	96	48	7,87	SNR
95	UC319D1	200	103	51	8,7	NTN
95	UC319G2	200	103	50	8,91	SNR
100	UC320D1	215	108	55	10,8	NTN
100	UC320G2	215	108	54	11,2	SNR
105	UC321	225	112	57	12,2	NTN / SNR
110	UC322D1	240	117	59	14,3	NTN
110	UC322G2	240	117	60	14,3	SNR
120	UC324D1	260	126	63	18,5	NTN
120	UC324G2	260	126	64	18,5	SNR
130	UC326D1	280	135	67	23	NTN
130	UC326G2	280	135	68	23	SNR
140	UC328D1	300	145	71	28,5	NTN
140	UC328G2	300	145	73	28,5	SNR

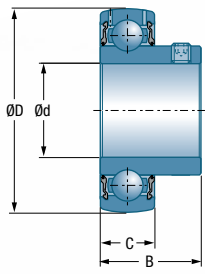

Ø d	Reference	D	B	C	Kg	Brands
12	AS201D1	40	22	12	0,1	NTN
12	US201G2	40	22	12	0,09	SNR
15	AS202D1	40	22	12	0,09	NTN
15	US202G2	40	22	12	0,08	SNR
17	AS203D1	40	22	12	0,08	NTN
17	US203G2	40	22	12	0,1	SNR
20	AS204D1	47	25	14	0,13	NTN
20	US204G2	47	25	14	0,13	SNR
25	AS205D1	52	27	15	0,16	NTN
25	US205G2	52	27	15	0,17	SNR
30	AS206D1	62	29	16	0,25	NTN
30	US206G2	62	30	16	0,27	SNR
35	AS207D1	72	34	17	0,37	NTN
35	US207G2	72	32	17	0,42	SNR
40	AS208D1	80	38	18	0,5	NTN
40	US208G2	80	34	18	0,6	SNR
45	US209G2	85	41,2	19	0,65	SNR
50	US210G2	90	43,5	20	0,76	SNR
55	US211G2	100	45,3	23	1,07	SNR
60	US212G2	110	53,7	24	1,3	SNR

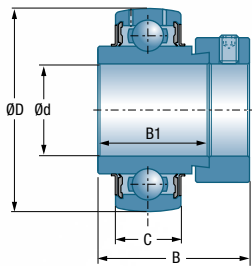

Ø d	Reference	D	B	B1	C	Kg	Brands
12	EX201G2	47	43,5	34	16	0,29	SNR
15	EX202G2	47	43,5	34	16	0,27	SNR
17	EX203G2	47	43,5	34	16	0,25	SNR
20	UEL204D1	47	43,7	34,2	17	0,23	NTN
20	EX204G2	47	43,5	34	16	0,22	SNR
25	UEL205D1	52	44,4	34,9	17	0,27	NTN
25	EX205G2	52	44,3	34,8	17	0,25	SNR
30	UEL206D1	62	48,4	36,5	19	0,45	NTN
30	EX206G2	62	48,3	36,4	19	0,41	SNR
35	UEL207D1	72	51,1	37,6	20	0,6	NTN
35	EX207G2	72	51,1	37,6	20	0,6	SNR
40	UEL208D1	80	56,3	42,8	21	0,79	NTN
40	EX208G2	80	56,3	42,8	21	0,78	SNR
45	UEL209D1	85	56,3	42,8	22	0,85	NTN
45	EX209G2	85	56,3	42,8	22	0,87	SNR
50	UEL210D1	90	62,7	49,2	24	0,98	NTN
50	EX210G2	90	62,7	49,2	23	1,01	SNR
55	UEL211D1	100	71,4	55,5	25	1,32	NTN
55	EX211G2	100	71,3	55,4	25	1,39	SNR
60	UEL212D1	110	77,8	61,9	27	1,87	NTN
60	EX212G2	110	77,7	61,8	27	1,87	SNR
65	UEL213D1	120	85,7	68,3	32	2,48	NTN
65	EX213G2	120	85,7	68,2	28	2,41	SNR
70	UEL214D1	125	85,7	68,3	33	2,47	NTN
70	EX214G2	125	85,7	68,2	30	2,57	SNR
75	UEL215D1	130	92	74,6	34	2,68	NTN
75	EX215G2	130	92,1	74,6	30	2,84	SNR
80	EX216G2	140	95,2	74,6	33	3,12	SNR
85	EX217G2	150	73,2	53,2	35	3,72	SNR
90	EX218G2	160	72,5	55	37	4,9	SNR

Ø d	Reference	D	B	B1	C	Kg	Brands
25	EX305G2	62	46,8	34,9	21	0,43	SNR
25	UEL305D1	62	46,8	34,9	20	0,43	NTN
30	EX306G2	72	50	36,5	24	0,68	SNR
30	UEL306D1	72	50	36,5	23	0,69	NTN
35	EX307G2	80	51,6	38,1	25	0,8	SNR
35	UEL307D1	80	51,6	38,1	25	0,8	NTN
40	EX308G2	90	57,1	41,3	28	1,08	SNR
40	UEL308D1	90	57,1	41,3	27	1,08	NTN
45	EX309G2	100	58,7	42,9	30	1,45	SNR
45	UEL309D1	100	58,7	42,9	29	1,45	NTN
50	EX310G2	110	66,6	49,2	32	1,86	SNR
50	UEL310D1	110	66,6	49,2	32	1,86	NTN
55	EX311G2	120	73	55,6	34	2,3	SNR
55	UEL311D1	120	73	55,6	34	2,34	NTN
60	EX312G2	130	79,4	61,9	36	2,89	SNR
60	UEL312D1	130	79,4	61,9	36	2,94	NTN
65	EX313G2	140	85,7	65,1	38	3,66	SNR
65	UEL313D1	140	85,7	65,1	39	3,67	NTN
70	EX314G2	150	92,1	68,3	40	4,5	SNR
70	UEL314D1	150	92,1	68,3	41	4,4	NTN
75	EX315G2	160	100	74,6	42	5,34	SNR
75	UEL315D1	160	100	74,6	43	5,34	NTN
80	EX316G2	170	106,4	81	44	6,7	SNR
80	UEL316D1	170	106,4	81	45	6,7	NTN
85	EX317G2	180	109,5	84,1	46	7,96	SNR
85	UEL317D1	180	109,5	84,1	47	8	NTN
90	EX318G2	190	115,9	87,3	48	9,1	SNR
90	UEL318D1	190	115,9	87,3	49	9,1	NTN
95	EX319G2	200	122,3	93,7	50	10,4	SNR
95	UEL319D1	200	122,3	93,7	51	10,4	NTN
100	EX320G2	215	128,6	100	54	13	SNR
100	UEL320D1	215	128,6	100	55	12,5	NTN
105	UEL321D1	225	139,7	104,8	57	14,6	NTN
110	UEL322D1	240	141,3	106,4	59	17,2	NTN



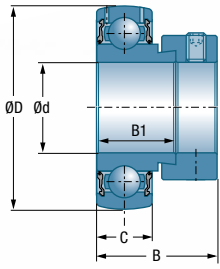

Ø d	Reference	D	B	B1	C	Kg	Brands
12	AEL201D1	40	28,6	19	12	0,12	NTN
12	ES201G2	40	28,6	19,1	12	0,14	SNR
15	AEL202D1	40	28,6	19	12	0,11	NTN
15	ES202G2	40	28,6	19,1	12	0,13	SNR
17	AEL203D1	40	28,6	19	12	0,1	NTN
17	ES203G2	40	28,6	19,1	12	0,13	SNR
20	AEL204D1	47	31	21,5	14	0,17	NTN
20	ES204G2	47	30,9	21,4	14	0,15	SNR
25	AEL205D1	52	31	21,5	15	0,2	NTN
25	ES205G2	52	30,9	21,4	15	0,19	SNR
30	AEL206D1	62	35,7	23,8	16	0,31	NTN
30	ES206G2	62	35,7	23,8	16	0,33	SNR
35	AEL207D1	72	38,9	25,4	17	0,49	NTN
35	ES207G2	72	38,9	25,4	17	0,5	SNR
40	AEL208D1	80	43,7	30,2	18	0,66	NTN
40	ES208G2	80	43,7	30,2	18	0,65	SNR
45	ES209G2	85	43,7	30,2	19	0,69	SNR
50	ES210G2	90	43,7	30,2	20	0,8	SNR
55	ES211G2	100	48,4	32,5	24	0,87	SNR
60	ES212G2	110	49,3	33,4	24	1,2	SNR

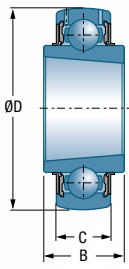

Ø d	Reference	Ø K+H	D	B	C	Kg	Brands
25	UK205D1	20	52	23	17	0,25	NTN
25	UK205G2	20	52	21	17	0,24	SNR
20	UK205G2H	20	52	21	17	0,24	SNR
30	UK206D1	25	62	26	19	0,36	NTN
30	UK206G2	25	62	25	19	0,38	SNR
25	UK206G2H	25	62	25	19	0,38	SNR
35	UK207D1	30	72	29	20	0,57	NTN
35	UK207G2	30	72	27	20	0,54	SNR
30	UK207G2H	30	72	27	20	0,54	SNR
40	UK208D1	35	80	31	21	0,74	NTN
40	UK208G2	35	80	29	21	0,7	SNR
35	UK208G2H	35	80	29	21	0,7	SNR
45	UK209D1	40	85	31	22	0,83	NTN
45	UK209G2	40	85	30	22	0,81	SNR
40	UK209G2H	40	85	30	22	0,81	SNR
50	UK210D1	45	90	32	24	0,97	NTN
50	UK210G2	45	90	31	23	0,95	SNR
45	UK210G2H	45	90	31	23	0,95	SNR
55	UK211D1	50	100	35	25	1,26	NTN
55	UK211G2	50	100	33	25	1,19	SNR
50	UK211G2H	50	100	33	25	1,19	SNR
60	UK212D1	55	110	38	27	1,59	NTN
60	UK212G2	55	110	36	27	1,51	SNR
55	UK212G2H	55	110	36	27	1,51	SNR
65	UK213D1	60	120	40	32	2	NTN
65	UK213G2	60	120	36	28	1,92	SNR
60	UK213G2H	60	120	36	28	1,92	SNR
75	UK215D1	65	130	44	34	2,56	NTN
75	UK215G2	65	130	41	30	2,72	SNR
65	UK215G2H	65	130	41	30	2,72	SNR
80	UK216D1	70	140	45	35	3,23	NTN
80	UK216G2	70	140	44	33	3,24	SNR
70	UK216G2H	70	140	44	33	3,24	SNR
85	UK217D1	75	150	46	36	3,93	NTN
86	UK217G2	75	150	44	35	3,87	SNR
75	UK217G2H	75	150	44	35	3,87	SNR
90	UK218D1	80	160	47	37	4,74	NTN
90	UK218G2	80	160	48	37	4,69	SNR
80	UK218G2H	80	160	48	37	4,69	SNR

Ø d	Reference	Ø K+H	D	B	C	Kg	Brands
25	UK305D1	20	62	26	20	0,36	NTN
25	UK305G2	20	62	27	21	0,49	SNR
20	UK305G2H	20	62	27	21	0,49	SNR
30	UK306D1	25	72	29	23	0,59	NTN
30	UK306G2	25	72	30	24	0,59	SNR
25	UK306G2H	25	72	30	24	0,59	SNR
35	UK307D1	30	80	33	25	0,75	NTN
35	UK307G2	30	80	33	25	0,92	SNR
30	UK307G2H	30	80	33	25	0,92	SNR
40	UK308D1	35	90	34	27	1,02	NTN
40	UK308G2	35	90	35	28	1,03	SNR
35	UK308G2H	35	90	35	28	1,03	SNR
45	UK309D1	40	100	37	29	1,38	NTN
45	UK309G2	40	100	38	30	1,47	SNR
40	UK309G2H	40	100	38	30	1,47	SNR
50	UK310D1	45	110	41	32	1,68	NTN
50	UK310G2	45	110	40	32	1,74	SNR
45	UK310G2H	45	110	40	32	1,74	SNR
55	UK311D1	50	120	44	34	2,06	NTN
55	UK311G2	50	120	43	34	2,2	SNR
50	UK311G2H	50	120	43	34	2,2	SNR
60	UK312D1	55	130	47	36	2,53	NTN
60	UK312G2	55	130	47	36	2,54	SNR
55	UK312G2H	55	130	47	36	2,54	SNR
60	UK313D1	60	140	49	39	3,08	NTN
65	UK313G2	60	140	49	38	3,27	SNR
65	UK313G2H	60	140	49	38	3,27	SNR
75	UK315D1	65	160	55	43	4,84	NTN
75	UK315G2	65	160	55	42	5,03	SNR
65	UK315G2H	65	160	55	42	5,03	SNR
80	UK316D1	70	170	58	45	5,75	NTN
80	UK316G2	70	170	55	44	5,83	SNR
70	UK316G2H	70	170	55	44	5,83	SNR
85	UK317D1	75	180	60	47	6,72	NTN
85	UK317G2	75	180	60	46	6,89	SNR
75	UK317G2H	75	180	60	46	6,89	SNR
90	UK318D1	80	190	64	49	7,87	NTN
90	UK318G2	80	190	60	48	7,94	SNR
80	UK318G2H	80	190	60	48	7,94	SNR
95	UK319D1	85	200	67	51	9,02	NTN
95	UK319G2	85	200	66	50	9,23	SNR
85	UK319G2H	85	200	66	50	9,23	SNR
100	UK320D1	90	215	73	55	11,1	NTN
100	UK320G2	90	215	68	54	10,97	SNR
90	UK320G2H	90	215	68	54	10,97	SNR
110	UK322D1	100	240	80	59	14,9	NTN
110	UK322G2	100	240	80	60	17,64	SNR
100	UK322G2H	100	240	80	60	17,64	SNR
120	UK324D1	110	260	86	63	18	NTN
120	UK324G2	110	260	86	64	21,19	SNR
110	UK324G2H	110	260	86	64	21,19	SNR
130	UK326D1	115	280	90	67	23,3	NTN
130	UK326G2	115	280	92	68	27,9	SNR
115	UK326G2H	115	280	92	68	27,9	SNR
140	UK328D1	125	300	95	71	28,9	NTN
140	UK328G2	125	300	98	73	34,45	SNR
125	UK328G2H	125	300	98	73	34,45	SNR



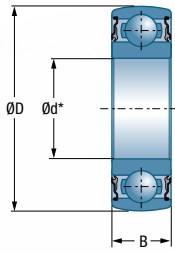

Ø d	Reference	D	B	Kg	Brands
10	CS200LLU	30	9	0,03	NTN
12	CS201LLU	32	10	0,04	NTN
15	CS202LLU	35	11	0,04	NTN
17	CS203 (6203SEE)	40	12	0,06	SNR
17	CS203LLU	40	12	0,06	NTN
20	CS204 (6204SEE)	47	14	0,1	SNR
20	CS204LLU	47	14	0,1	NTN
25	CS205 (6205SEE)	52	15	0,13	SNR
25	CS205LLU	52	15	0,13	NTN
30	CS206 (6206SEE)	62	16	0,2	SNR
30	CS206LLU	62	16	0,2	NTN
35	CS207 (6207SEE)	72	17	0,29	SNR
35	CS207LLU	72	17	0,29	NTN
40	CS208 (6208SEE)	80	18	0,37	SNR
40	CS208LLU	80	18	0,37	NTN
45	CS209 (6209SEE)	85	19	0,4	SNR
45	CS209LLU	85	19	0,4	NTN
50	CS210 (6210SEE)	90	20	0,47	SNR
50	CS210LLU	90	20	0,47	NTN
60	6212SEE	110	22	0,78	SNR
60	CS212LLU	110	22	0,78	NTN
65	CS213LLU	120	23	0,97	NTN

Ø d	Reference	D	B	Kg	Brands
25	CS305LLU	62	17	0,22	NTN
30	CS306LLU	72	19	0,34	NTN
35	CS307LLU	80	21	0,49	NTN
40	CS308 (6308SEE)	90	23	0,62	SNR
40	CS308LLU	90	23	0,62	NTN
45	CS309 (6309SEE)	100	25	0,8	SNR
45	CS309LLU	100	25	0,8	NTN
50	CS310LLU	110	27	1,06	NTN

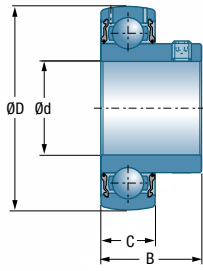

Ø d	Reference	D	B	C	Kg	Brands
12	UCS201LD1N	47	31	17	0,21	NTN
15	UCS202LD1N	47	31	17	0,2	NTN
17	UCS203LD1N	47	31	17	0,18	NTN
20	UCS204LD1N	47	31	17	0,17	NTN
20	CUC204	47	31	17	0,2	SNR
25	UCS205LD1N	52	34,1	17	0,2	NTN
25	CUC205	52	34	17	0,21	SNR
30	UCS206LD1N	62	38,1	19	0,33	NTN
30	CUC206	62	38,1	19	0,35	SNR
35	UCS207LD1N	72	42,9	20	0,49	NTN
35	CUC207	72	42,9	20	0,47	SNR
40	UCS208LD1N	80	49,2	21	0,65	NTN
40	CUC208	80	49,2	21	0,64	SNR
45	UCS209LD1N	85	49,2	22	0,7	NTN
45	CUC209	85	49,2	22	0,68	SNR
50	UCS210LD1N	90	51,6	24	0,8	NTN
50	CUC210	90	51,6	23	0,8	SNR
55	UCS211LD1N	100	55,6	25	1,08	NTN
60	UCS212LD1N	110	65,1	27	1,59	NTN
65	UCS213D1	120	65,1	32	1,92	NTN
70	UCS214D1	125	74,6	33	2,17	NTN
75	UCS215D1	130	77,8	34	2,43	NTN
80	UCS216D1	140	82,6	35	2,89	NTN
85	UCS217D1	150	85,7	36	3,47	NTN
90	UCS218D1	160	96	37	4,46	NTN

Ø d	Reference	D	B	C	Kg	Brands
25	UCS305D1	62	38	20	0,37	NTN
30	UCS306D1	72	43	23	0,58	NTN
35	UCS307D1	80	48	25	0,74	NTN
40	UCS308D1	90	52	27	1	NTN
45	UCS309D1	100	57	29	1,33	NTN
50	UCS310D1	110	61	32	1,72	NTN
55	UCS311D1	120	66	34	2,15	NTN
60	UCS312D1	130	71	36	2,7	NTN
65	UCS313D1	140	75	39	3,37	NTN
70	UCS314D1	150	78	41	4,03	NTN
75	UCS315D1	160	82	43	4,88	NTN
80	UCS316D1	170	86	45	5,74	NTN
85	UCS317D1	180	96	47	6,88	NTN
90	UCS318D1	190	96	49	7,8	NTN
95	UCS319D1	200	103	51	8,97	NTN
100	UCS320D1	215	108	55	11,1	NTN
105	UCS321D1	225	112	57	12,6	NTN
110	UCS322D1	240	117	59	14,7	NTN
120	UCS324D1	260	126	63	19	NTN
130	UCS326D1	280	135	67	23,6	NTN
140	UCS328D1	300	145	71	29,2	NTN



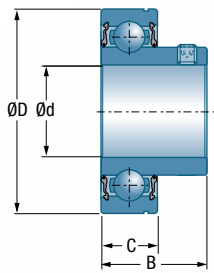

Ø d	Reference	D	B	C	Kg	Brands
12	ASS201N	40	22	12	0,12	NTN
15	ASS202N	40	22	12	0,11	NTN
17	ASS203N	40	22	12	0,1	NTN
20	ASS204N	47	25	14	0,17	NTN
20	CUS204	47	25	14	0,13	SNR
25	ASS205N	52	27	15	0,2	NTN
25	CUS205	52	27	15	0,17	SNR
30	ASS206N	62	29	16	0,31	NTN
30	CUS206	62	30	16	0,27	SNR
35	ASS207N	72	34	17	0,49	NTN
35	CUS207	72	32	17	0,42	SNR
40	ASS208N	80	38	18	0,5	NTN
40	CUS208	80	34	18	0,48	SNR
45	CUS209	85	41,2	19	0,57	SNR
50	CUS210	90	43,5	20	0,66	SNR

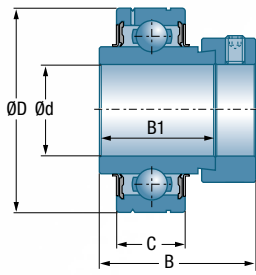

Ø d	Reference	D	B	B1	C	Kg	Brands
20	CEX204	47	43,7	34,2	17	0,22	SNR
20	UELS204LD1N	47	43,7	34,2	17	0,23	NTN
25	CEX205	52	44,4	34,9	17	0,25	SNR
25	UELS205LD1N	52	44,4	34,9	17	0,27	NTN
30	CEX206	62	48,4	36,5	19	0,41	SNR
30	UELS206LD1N	62	48,4	36,5	19	0,45	NTN
35	CEX207	72	51,1	37,6	20	0,6	SNR
35	UELS207LD1N	72	51,1	37,6	20	0,6	NTN
40	CEX208	80	56,3	42,8	21	0,78	SNR
40	UELS208LD1N	80	56,3	42,8	21	0,79	NTN
45	CEX209	85	56,3	42,8	22	0,87	SNR
45	UELS209LD1N	85	56,3	42,8	22	0,85	NTN
50	CEX210	90	62,7	49,2	24	1,01	SNR
50	UELS210LD1N	90	62,7	49,2	24	0,98	NTN
55	UELS211LD1N	100	71,4	55,5	25	1,32	NTN
60	UELS212LD1N	110	77,8	61,9	27	1,93	NTN

Ø d	Reference	D	B	B1	C	Kg	Brands
25	UELS305D1N	62	46,8	34,9	20	0,45	NTN
30	UELS306D1N	72	50	36,5	23	0,71	NTN
35	UELS307D1N	80	51,6	38,1	25	0,83	NTN
40	UELS308D1N	90	57,1	41,3	27	1,12	NTN
45	UELS309D1N	100	58,7	42,9	29	1,5	NTN
50	UELS310D1N	110	66,6	49,2	32	1,93	NTN
55	UELS311D1N	120	73	55,6	34	2,42	NTN
60	UELS312D1N	130	79,4	61,9	36	3,04	NTN
65	UELS313D1N	140	85,7	65,1	39	3,79	NTN
70	UELS314D1N	150	92,1	68,3	41	4,54	NTN
75	UELS315D1N	160	100	74,6	43	5,5	NTN
80	UELS316D1N	170	106,4	81	45	6,89	NTN
85	UELS317D1N	180	109,5	84,1	47	8,21	NTN
90	UELS318D1N	190	115,9	87,3	49	9,34	NTN



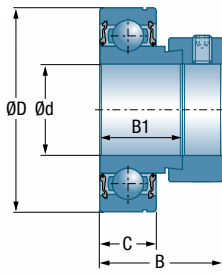

Ø d	Reference	D	B	B1	C	Kg	Brands
12	AELS201N	40	28.6	19	12	0,12	NTN
15	AELS202N	40	28.6	19	12	0,11	NTN
17	AELS203N	40	28.6	19	12	0,1	NTN
20	AELS204N	47	31	21,5	14	0,17	NTN
20	CES204	47	31	21,5	14	0,15	SNR
25	AELS205N	52	31	21,5	15	0,2	NTN
25	CES205	52	31	21,5	15	0,19	SNR
30	AELS206N	62	35,7	23,8	16	0,31	NTN
30	CES206	62	35,7	23,8	16	0,33	SNR
35	AELS207N	72	38,9	25,4	17	0,49	NTN
35	CES207	72	38,9	25,4	17	0,5	SNR
40	AELS208N	80	43,7	30,2	18	0,66	NTN
40	CES208	80	43,7	30,2	18	0,65	SNR
45	CES209	85	43,7	30,2	19	0,69	SNR
50	AELS210N	90	43,7	30,2	20	0,74	NTN
50	CES210	90	43,7	30,2	20	0,8	SNR

2-part pillow blocks, SNC range / Paliers en deux parties standards, gamme SNC / Zweigeteilte Lagergehäuse, Reihe SNC / Supporti in due parti, serie SNC / Soportes en dos partes, gama SNC / Mancais bipartidos, gama SNC / Разъёмные корпуса SNC для подшипников / 2-częściowe oprawy dzielone, gama SNC

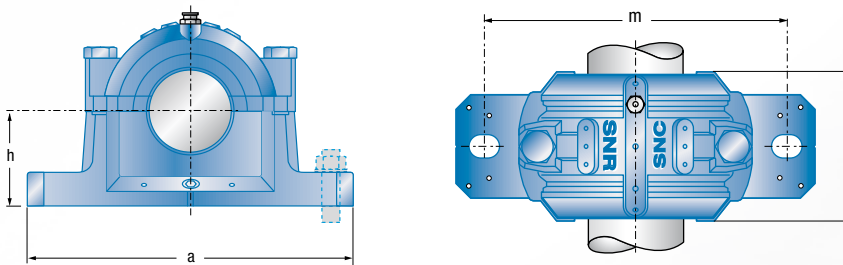

d	Housing	a	h	l	m	Grease Regulation Disc	Bearing	Adapter Sleeve	Locating Ring
Shaft mm									2 pieces per housing
20	SNC505	165	40	67	130	RDC505	1205K 2205K 22205K	H205 H305 H305	FR52x5 FR52x3,5 FR52x3,5
	SNC605	185	50	77	150	RDC605	1305K 2305K 21305K	H305 H2305 H305	FR62x7,5 FR62x4 FR62x7,5
25	SNC506	185	50	77	150	RDC506	1206K 2206K 22206K	H206 H306 H306	FR62x8 FR62x6 FR62x6
	SNC606	185	50	82	150	RDC606	1306K 2306K 21306K	H306 H2306 H306	FR72x7,5 FR72x3,5 FR72x7,5
30	SNC507	185	50	82	150	RDC507	1207K 2207K 22207K	H207 H307 H307	FR72x8,5 FR72x5,5 FR72x5,5
	SNC607	205	60	85	170	RDC607	1307K 2307K 21307K	H307 H2307 H307	FR80x9 FR80x4 FR80x9
35	SNC508	205	60	85	170	RDC508	1208K 2208K 22208K	H208 H308 H308	FR80x10,5 FR80x8 FR80x8
	SNC608	205	60	90	170	RDC608	1308K 2308K 21308K 22308K	H308 H2308 H308 H2308	FR90x9 FR90x4 FR90x9 FR90x4
40	SNC509	205	60	85	170	RDC509	1209K 2209K 22209K	H209 H309 H309	FR85x5,5 FR85x3,5 FR85x3,5
	SNC609	255	70	95	210	RDC609	1309K 2309K 21309K 22309K	H309 H2309 H309 H2309	FR100x9,5 FR100x4 FR100x9,5 FR100x4
45	SNC510	205	60	90	170	RDC510	1210K 2210K 22210K	H210 H310 H310	FR90x10,5 FR90x9 FR90x9
	SNC610	255	70	105	210	RDC610	1310K 2310K 21310K 22310K	H310 H2310 H310 H2310	FR110x10,5 FR110x4 FR110x10,5 FR110x4



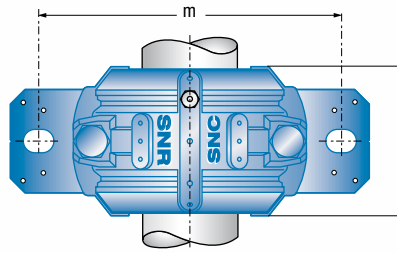
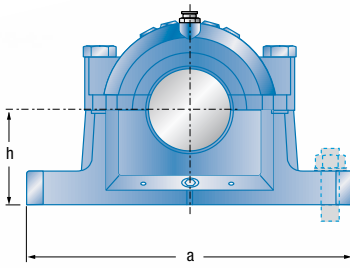

d	Housing	a	h	l	m	Grease Regulation Disc	Bearing	Adapter Sleeve	Locating Ring
Shaft mm									2 pieces per housing
50	SNC511	255	70	95	210	RDC511	1211K 2211K 22211K	H211 H311 H311	FR100x11,5 FR100x9,5 FR100x9,5
	SNC611	275	80	110	230	RDC611	1311K 2311K 21311K 22311K	H311 H2311 H311 H2311	FR120x11 FR120x4 FR120x11 FR120x4
55	SNC512	255	70	105	210	RDC512	1212K 2212K 22212K	H212 H312 H312	FR110x13 FR110x10 FR110x10
	SNC612	280	80	115	230	RDC612	1312K 2312K 21312K 22312K	H312 H2312 H312 H2312	FR130x12,5 FR130x5 FR130x12,5 FR130x5
60	SNC513	275	80	110	230	RDC513	1213K 2213K 22213K	H213 H213 H313	FR120x14 FR120x10 FR120x10
	SNC613	315	95	120	260	RDC613	1313K 2313K 21313K 22313K	H313 H2313 H313 H2313	FR140x12,5 FR140x5 FR140x12,5 FR140x5
65	SNC515	280	80	115	230	RDC515	1215K 2215K 22215K	H215 H315 H315	FR130x15,5 FR130x12,5 FR130x12,5
	SNC615	345	100	140	290	RDC615	1315K 2315K 21315K 22315K	H315 H2315 H315 H2315	FR160x14 FR160x5 FR160x14 FR160x5
70	SNC516	315	95	120	260	RDC516	1216K 2216K 22216K	H216 H316 H316	FR140x16 FR140x12,5 FR140x12,5
	SNC616	345	112	145	290	RDC616	1316K 2316K 21316K 22316K	H316 H2316 H316 H2316	FR170x14,5 FR170x5 FR170x14,5 FR170x5
75	SNC517	320	95	125	260	RDC517	1217K 2217K 22217K	H217 H317 H317	FR150x16,5 FR150x12,5 FR150x12,5
	SNC617	380	112	160	320	RDC617	1317K 2317K 21317K 22317K	H317 H2317 H317 H2317	FR180x14,5 FR180x5 FR180x14,5 FR180x5

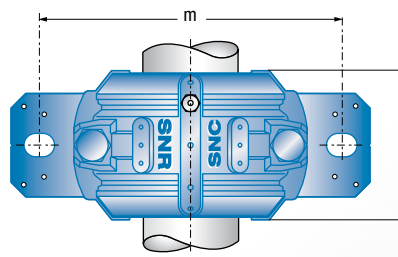
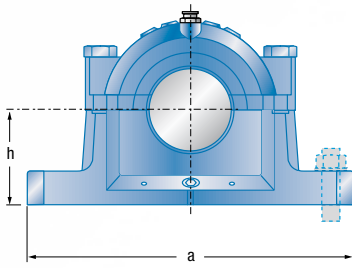

d	Housing	a	h	l	m	Grease Regulation Disc	Bearing	Adapter Sleeve	Locating Ring
Shaft mm									2 pieces per housing
80	SNC518	345	100	140	290	RDC518	1218K 2218K 22218K 23218K	H218 H318 H318 H2318	FR160x17,5 FR160x12,5 FR160x12,5 FR160x6,25
	SNC618	380	112	160	320	RDC618	1318K 2318K 21318K 22318K	H318 H2318 H318 H2318	FR190x15,5 FR190x5 FR190x15,5 FR190x5
85	SNC519	345	112	145	290	RDC519	1219K 2219K 22219K	H219 H319 H319	FR170x18 FR170x12,5 FR170x12,5
	SNC619	410	125	175	350	RDC619	1319K 2319K 21319K 22319K	H319 H2319 H319 H2319	FR200x17,5 FR200x6,5 FR200x17,5 FR200x6,5
90	SNC520	380	112	160	320	RDC520	1220K 2220K 22220K 23220K	H220 H320 H320 H2320	FR180x18 FR180x12 FR180x12 FR180x4,85
	SNC620	410	140	185	350	RDC620	1320K 2320K 21320K 22320K	H320 H2320 H320 H2320	FR215x19,5 FR215x6,5 FR215x19,5 FR215x6,5
100	SNC522	410	125	175	350	RDC522	1222K 2222K 22222K 23222K	H222 H322 H322 H2322	FR200x21 FR200x13,5 FR200x13,5 FR200x5,1
	SNC524	410	140	185	350	RDC524	22224K 23224K	H3124 H2324	FR215x14 FR215x5
115	SNC526	445	150	190	380	RDC526	22226K 23226K	H3126 H2326	FR230x13 FR230x5
	SNC528	500	150	205	420	RDC528	22228K 23228K	H3128 H2328	FR250x15 FR250x5
135	SNC530	530	160	220	450	RDC530	22230K 23230K	H3130 H2330	FR270x16,5 FR270x5
	SNC532	550	170	235	470	RDC532	22232K 23232K	H3132 H2332	FR290x17 FR290x5



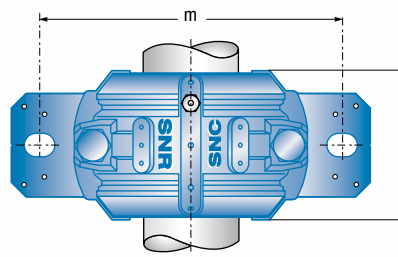
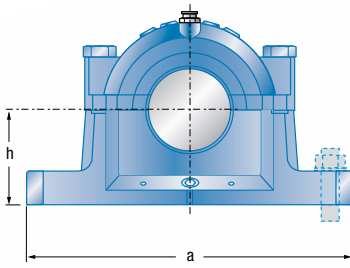

d1	Housing	a	h	l	m	Grease Regulation Disc	Bearing	Locating Ring
Shaft mm								2 pieces per housing
30	SNC205	165	40	67	130	RDC205	1205 2205 22205	FR52x5 FR52x3,5 FR52x3,5
	SNC305	185	50	77	150	RDC305	1305 2305 21305	FR62x7,5 FR62x4 FR62x7,5
35	SNC206	185	50	77	150	RDC206	1206 2206 22206	FR62x8 FR62x6 FR62x6
	SNC306	185	50	82	150	RDC306	1306 2306 21306	FR72x7,5 FR72x3,5 FR72x7,5
45	SNC207	185	50	82	150	RDC207	1207 2207 22207	FR72x8,5 FR72x5,5 FR72x5,5
	SNC307	205	60	85	170	RDC307	1307 2307 21307	FR80x9 FR80x4 FR80x9
50	SNC208	205	60	85	170	RDC208	1208 2208 22208	FR80x10,5 FR80x8 FR80x8
	SNC308	205	60	90	170	RDC308	1308 2308 21308 22308	FR90x9 FR90x4 FR90x9 FR90x4
55	SNC209	205	60	85	170	RDC209	1209 2209 22209	FR85x5,5 FR85x3,5 FR85x3,5
	SNC309	255	70	95	210	RDC309	1309 2309 21309 22309	FR100x9,5 FR100x4 FR100x9,5 FR100x4
60	SNC210	205	60	90	170	RDC210	1210 2210 22210	FR90x10,5 FR90x9 FR90x9
	SNC310	255	70	105	210	RDC310	1310 2310 21310 22310	FR110x10,5 FR110x4 FR110x10,5 FR110x4

d1 : outer diameter of shoulder of shaft

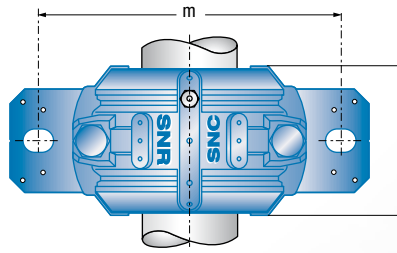
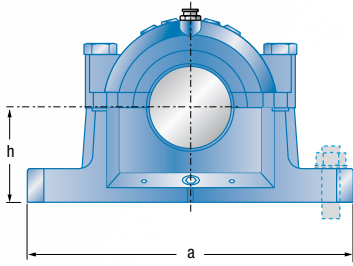

d1	Housing	a	h	l	m	Grease Regulation Disc	Bearing	Locating Ring
Shaft mm								2 pieces per housing
65	SNC211	255	70	95	210	RDC211	1211 2211 22211	FR100x11,5 FR100x9,5 FR100x9,5
	SNC311	275	80	110	230	RDC311	1311 2311 21311 22311	FR120x11 FR120x4 FR120x11 FR120x4
70	SNC212	255	70	105	210	RDC212	1212 2212 22212	FR110x13 FR110x10 FR110x10
	SNC312	280	80	115	230	RDC312	1312 2312 21312 22312	FR130x12,5 FR130x5 FR130x12,5 FR130x5
75	SNC213	275	80	110	230	RDC213	1213 2213 22213	FR120x14 FR120x10 FR120x10
	SNC313	315	95	120	260	RDC313	1313 2313 21313 22313	FR140x12,5 FR140x5 FR140x12,5 FR140x5
80	SNC214	275	80	115	230	RDC214	1214 2214 22214	FR125x10 FR125x6,5 FR125x6,5
	SNC314	320	95	125	260	RDC314	1314 2314 21314 22314	FR150x13 FR150x5 FR150x13 FR150x5
85	SNC215	280	80	115	230	RDC215	1215 2215 22215	FR130x15,5 FR130x12,5 FR130x12,5
	SNC315	345	100	140	290	RDC315	1315 2315 21315 22315	FR160x14 FR160x5 FR160x14 FR160x5
90	SNC216	315	95	120	260	RDC216	1216 2216 22216	FR140x16 FR140x12,5 FR140x12,5
	SNC316	345	112	145	290	RDC316	1316 2316 21316 22316	FR170x14,5 FR170x5 FR170x14,5 FR170x5

d1 : outer diameter of shoulder of shaft



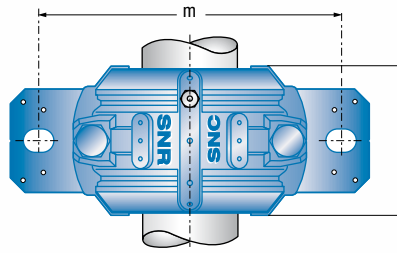
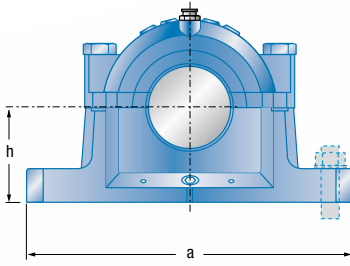

d1	Housing	a	h	l	m	Grease Regulation Disc	Bearing	Locating Ring
Shaft mm								2 pieces per housing
95	SNC217	320	95	125	260	RDC217	1217 2217 22217	FR150x16,5 FR150x12,5 FR150x12,5
	SNC317	380	112	160	320	RDC317	1317 2317 21317 22317	FR180x14,5 FR180x5 FR180x14,5 FR180x5
100	SNC218	345	100	140	290	RDC218	1218 2218 22218 23218	FR160x17,5 FR160x12,5 FR160x12,5 FR160x6,25
	SNC318	380	112	160	320	RDC318	1318 2318 21318 22318	FR190x15,5 FR190x5 FR190x15,5 FR190x5
110	SNC219	345	112	145	290	RDC219	1219 2219 22219	FR170x18 FR170x12,5 FR170x12,5
	SNC319	410	125	175	350	RDC319	1319 2319 21319 22319	FR200x17,5 FR200x6,5 FR200x17,5 FR200x6,5
115	SNC220	380	112	160	320	RDC220	1220 2220 22220 23220	FR180x18 FR180x12 FR180x12 FR180x4,85
	SNC320	410	140	185	350	RDC320	1320 2320 21320 22320	FR215x19,5 FR215x6,5 FR215x19,5 FR215x6,5
125	SNC222	410	125	175	350	RDC222	1222 2222 22222 23222	FR200x21 FR200x13,5 FR200x13,5 FR200x5,1
135	SNC224	410	140	185	350	RDC224	22224 23224	FR215x14 FR215x5
145	SNC226	445	150	190	380	RDC226	22226 23226	FR230x13 FR230x5
155	SNC228	500	150	205	420	RDC228	22228 23228	FR250x15 FR250x5
150	SNC230	530	160	220	450	RDC230	22230 23230	FR270x16,5 FR270x5
160	SNC232	550	170	235	470	RDC232	22232 23232	FR290x17 FR290x5

d1 : outer diameter of shoulder of shaft

Special pillow blocks / Paliers spéciaux / Speziallager / Supporti speciali / Soportes especiales / Mancais especiais / Специальные корпуса подшипников / Oprawy dzielone specjalne

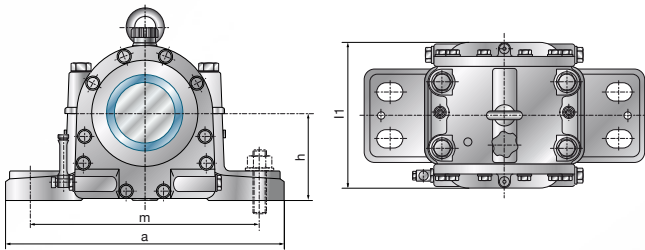

d	Housing Design AL/AF/AL/BL	a	h	l1	m
70	SN0E214	350	125	190	290
85	SN0E217	410	135	225	340
90	SN0E218	410	135	225	340
95	SN0E219	490	150	250	400
100	SN0E220	490	150	250	400
110	SN0E222	510	165	250	420
120	SN0E224	550	175	250	440
130	SN0E226	570	190	260	460
140	SN0E228	570	190	260	460
150	SN0E230	660	220	275	530
160	SN0E232	660	220	290	530
170	SN0E234-2	710	260	300	580
180	SN0E236-2	710	260	300	580
190	SN0E238-2	820	270	350	670
200	SN0E240-2	830	280	344	670
220	SN0E244-2	880	310	380	720
240	SN0E248-2	980	340	400	820
260	SN0E252-2	1070	370	440	900



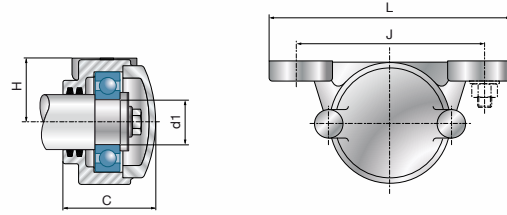
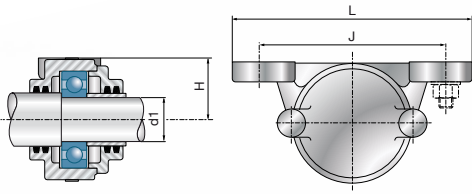

d1	Housing Design A/B	L	H	J
20	TVN204	150	35	110
25	TVN205	170	40	130
30	TVN206	190	50	150
35	TVN207	190	50	150
40	TVN208	210	60	170
45	TVN209	210	60	170
50	TVN210	210	60	170
55	TVN211	270	70	210
60	TVN212	270	70	210
65	TVN213	290	80	230
70	TVN214	290	80	230
75	TVN215	290	80	230

d1	Housing Design	L	H	J	C
35	TVN6207A	255	18	210	76
40	TVN6208A	255	17	210	81
45	TVN6209A	256	18	210	96
50	TVN6210A	270	23	210	102
55	TVN6211A	270	23	210	95
60	TVN6212A	290	25	230	108,5

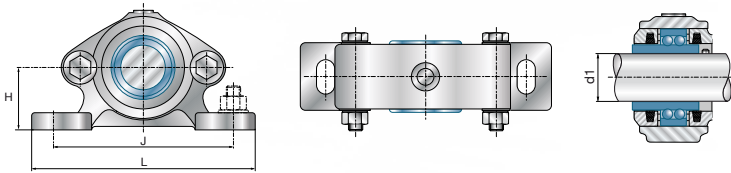

d1	Housing Design	L	H	J
20	TN 204	145	40	115
	TN 304	150	40	120
25	TN 205	150	40	120
	TN 305	165	50	130
30	TN 206	165	50	130
	TN 306	180	50	145
35	TN 207	180	50	145
	TN 307	195	55	160
40	TN 208	195	55	160
	TN 308	210	60	175
45	TN 209	210	60	175
	TN 309	230	65	190
50	TN 210	210	60	175
	TN 310	245	70	205
55	TN 211	230	65	190
60	TN 212	245	70	205

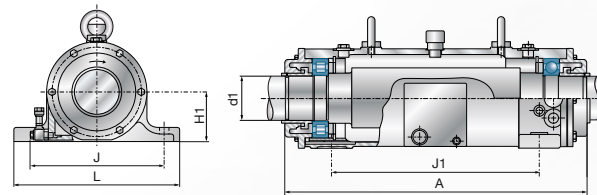
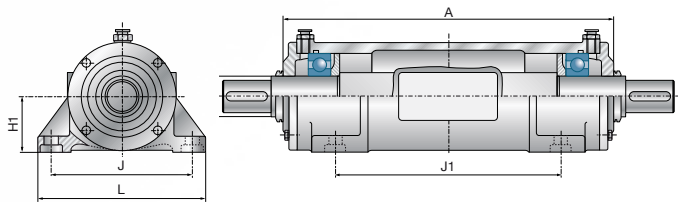

d	Housing Design AA-AF	L	H1	A	J	J1
30	ZLG306	170	50	235	130	150
35	ZLG307	190	60	275	150	175
40	ZLG308	190	60	330	150	225
45	ZLG309	210	70	370	170	250
50	ZLG310	210	70	405	170	275
55	ZLG311	270	80	433	210	300
60	ZLG312	270	80	479	210	340
65	ZLG313	290	95	503	230	360
70	ZLG314	290	95	534	230	380
70	DLG314	290	95	517	230	380
75	ZLG315	330	100	559	260	400
75	DLG315	330	100	553	260	400
80	ZLG316	330	112	585	260	420
80	DLG316	330	112	577	260	420
85	ZLG317	350	112	593	290	440
85	DLG317	350	112	593	290	440
90	ZLG318	350	112	605	290	460
90	DLG318	350	112	599	290	460
95	ZLG319	400	125	633	320	480
95	DLG319	400	125	626	320	480
100	ZLG320	400	130	673	320	500
100	DLG320	400	130	657	320	500
110	ZLG322	450	150	678	380	520
110	DLG322	450	150	678	380	520
120	ZLG324	500	160	705	410	540
120	DLG324	500	160	705	410	540

d	Housing Design A / B	L	H1	A	J	J1
75	ZLOE315/1	320	100	582,5	260	400
85	ZLOE317/1	350	112	645	290	440
90	ZLOE218/1	320	100	582,5	260	400
95	ZLOE219/1	350	112	645	290	440
95	ZLOE319/1	400	125	688,5	320	480
100	ZLOE220/1	350	112	645	290	440
100	ZLOE320/1	450	150	747	370	495
110	ZLOE222/1	400	125	688,5	320	480
120	ZLOE224/1	450	150	877	370	655



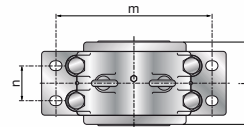
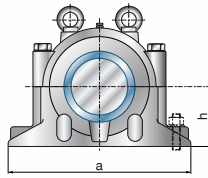
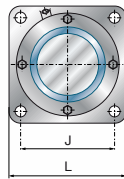
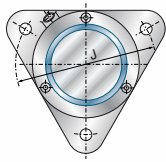
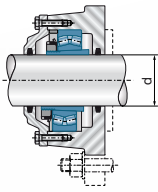

d1	Housing Design DA / DB	L	J
20	722505	110	96
25	722506	130	116
30	722507	145	130
35	722508	160	140
40	722509	180	160
45	722510	180	160
50	722511	192	170
55	722512	210	180
60	722513	225	190
65	722515	190	152
70	722516	196	152
75	722517	210	170
80	722518	210	170
90	722520	250	198
100	722522	270	219

d	Housing Design AF/AL/BF/BL	a	h	l	m	n
150	SD3134TS	510	170	230	430	100
160	SD3136TS	530	180	240	450	110
170	SD3138TS	560	190	260	480	120
180	SD3140TS	610	210	280	510	130
200	SD3144TS	640	220	290	540	140
220	SD3148TS	700	240	310	600	150
240	SD3152TS	770	260	320	650	160
260	SD3156TS	790	280	320	670	160
280	SD3160TS	830	300	350	710	190
300	SD3164TS	880	320	370	750	200
320	SD3168TS	965	340	400	840	240
340	SD3172TS	1040	360	400	890	255
360	SD3176TS	1120	380	400	980	255
380	SD3180TS	1245	400	430	1050	270
400	SD3184TS	1170	410	460	1000	260



High precision bearing



Hochpräzisionslager



Rodamientos
de alta precisión



Подшипники высокой
точности



Roulements
haute précision



Cuscinetti di super
precisione



Rolamentos
de alta precisão



Łożyska precyzyjne



Classification by references – Classification par références

Klassifizierung nach Referenzen – Classificazione per codice

Clasificación por referencias – Classificação por referências

Классификация по кодам – Klasyfikacja wg numerów katalogowych

NTN bearing designations

78, 79, 70, 72, BNT type

5S- 7 0 20 U AD T1 DB /GL P4

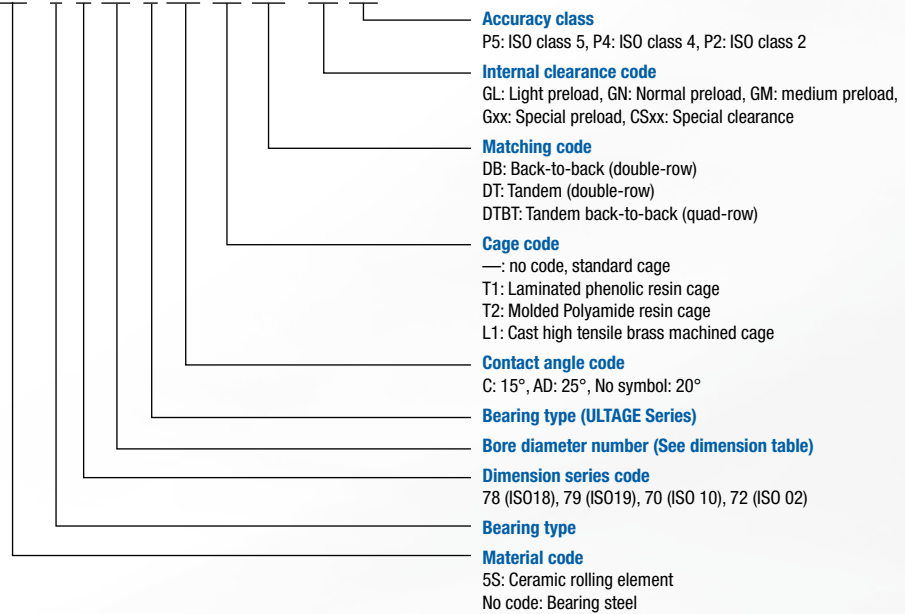

HSE type

5S- 2LA-HSE 0 20 AD DB /GL P4

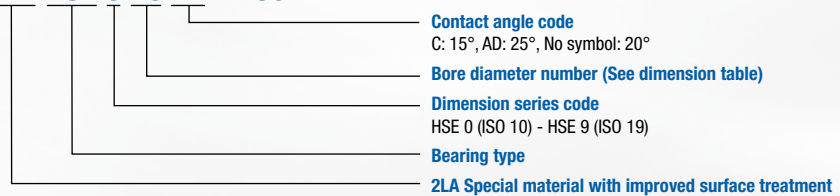

HSL type

5S- 2LA-HSL 0 20 DB +xx Dn /GL P4 +TKZ

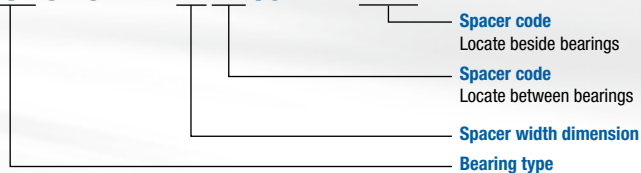

(notes) HSL: Bearing series code

xxDn: Eco-friendly nozzle, or Spacer with Eco- friendly nozzle locate between bearings (In case of HSL Type)

TKZ: Eco-friendly nozzle, or Spacer with Eco- friendly nozzle locate beside bearings (In case of HSL Type)

79LLB / 70LLB type

5S- 7006 CD LLB DB /GL P42 /L448

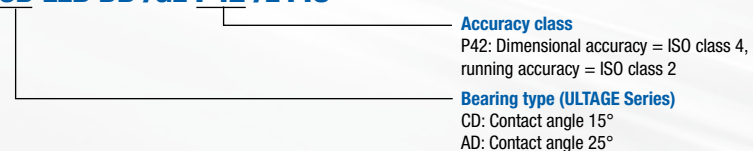

BNS type

5S- 2LA-BNS 0 20 LLB DB /GL P4 /L448



🇬🇧 SNR bearing designations

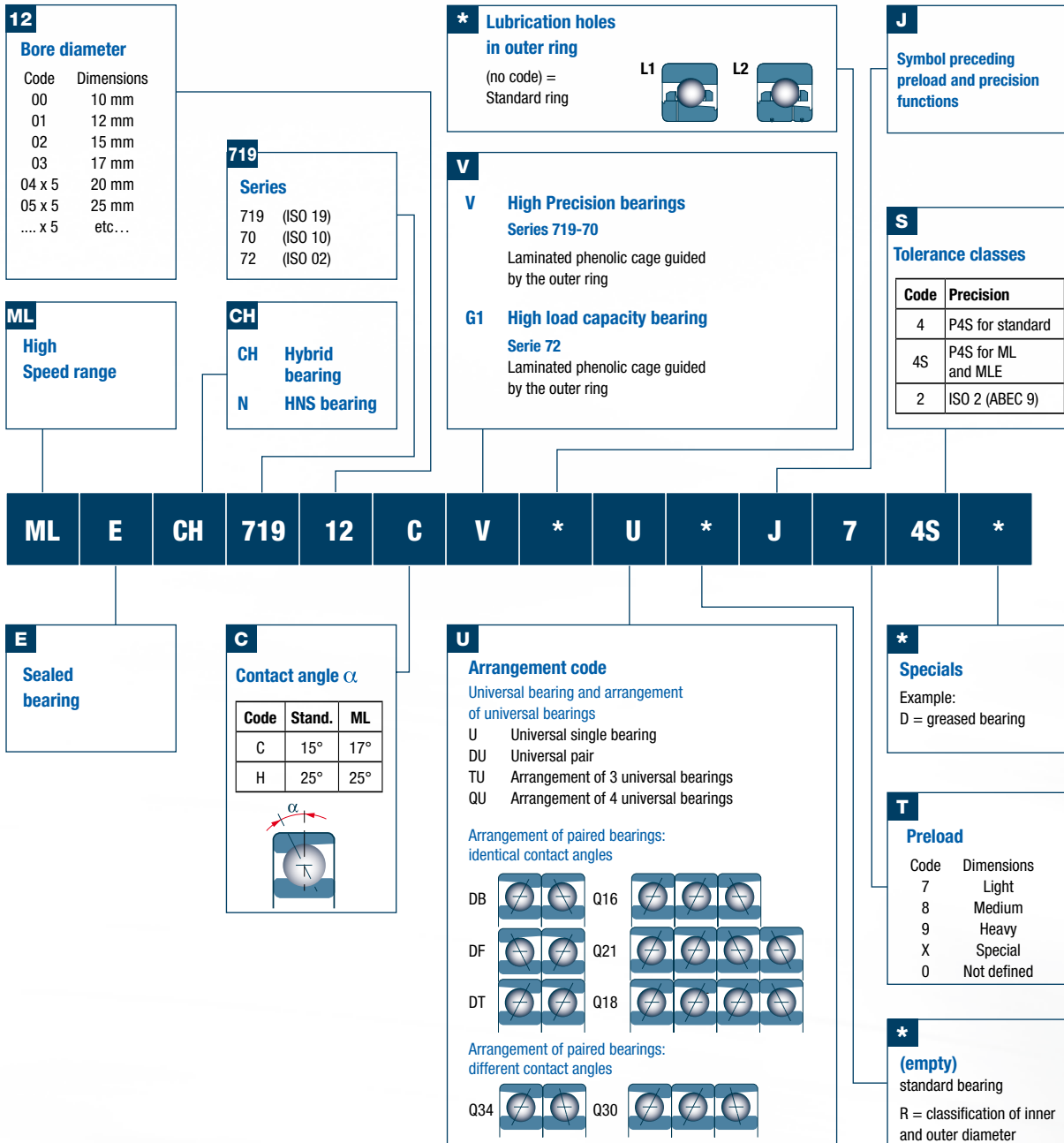

■ ■ Désignations des roulements NTN

78, 79, 70, 72, Type BNT

5S- 7 0 20 U AD T1 DB /GL P4

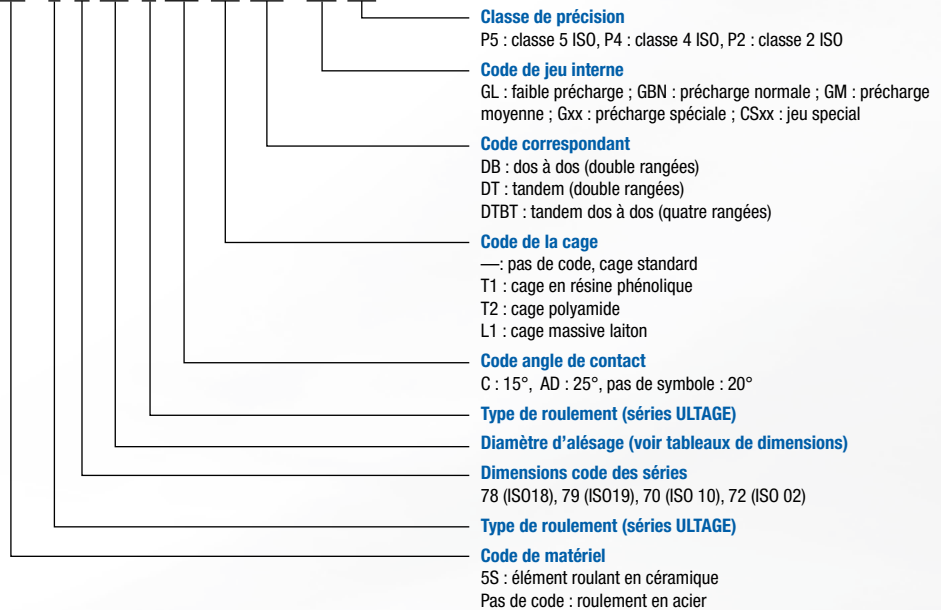

Type HSE

5S- 2LA-HSE 0 20 AD DB /GL P4

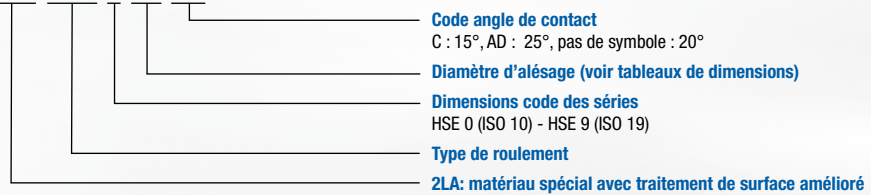

Type HSL

5S- 2LA-HSL 0 20 DB +xx Dn /GL P4 +TKZ

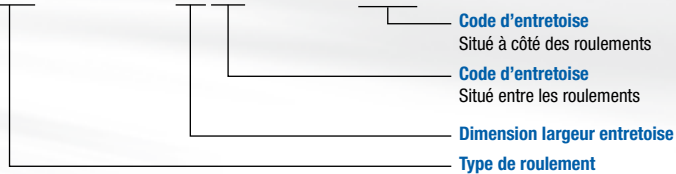

(notes) : HSL : code séries roulement

xxDn : Buse de lubrification éco-responsable, ou entretoise avec buse de lubrification éco-responsable situé entre les roulements (pour les types HSL)

TKZ : Buse de lubrification éco-responsable ou entretoise avec buse de lubrification éco-responsable situé à coté des roulements (pour les types HSL)

Type 79LLB / 70LLB

5S- 7006 CD LLB DB /GL P42 /L448

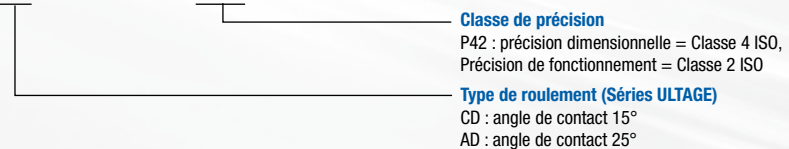

Type BNS

5S- 2LA-BNS 0 20 LLB DB /GL P4 /L448

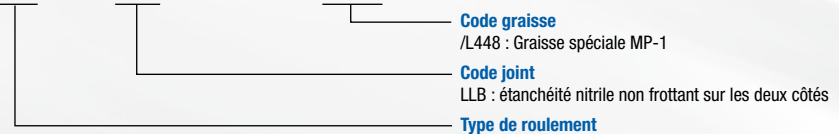

Désignations des roulements SNR

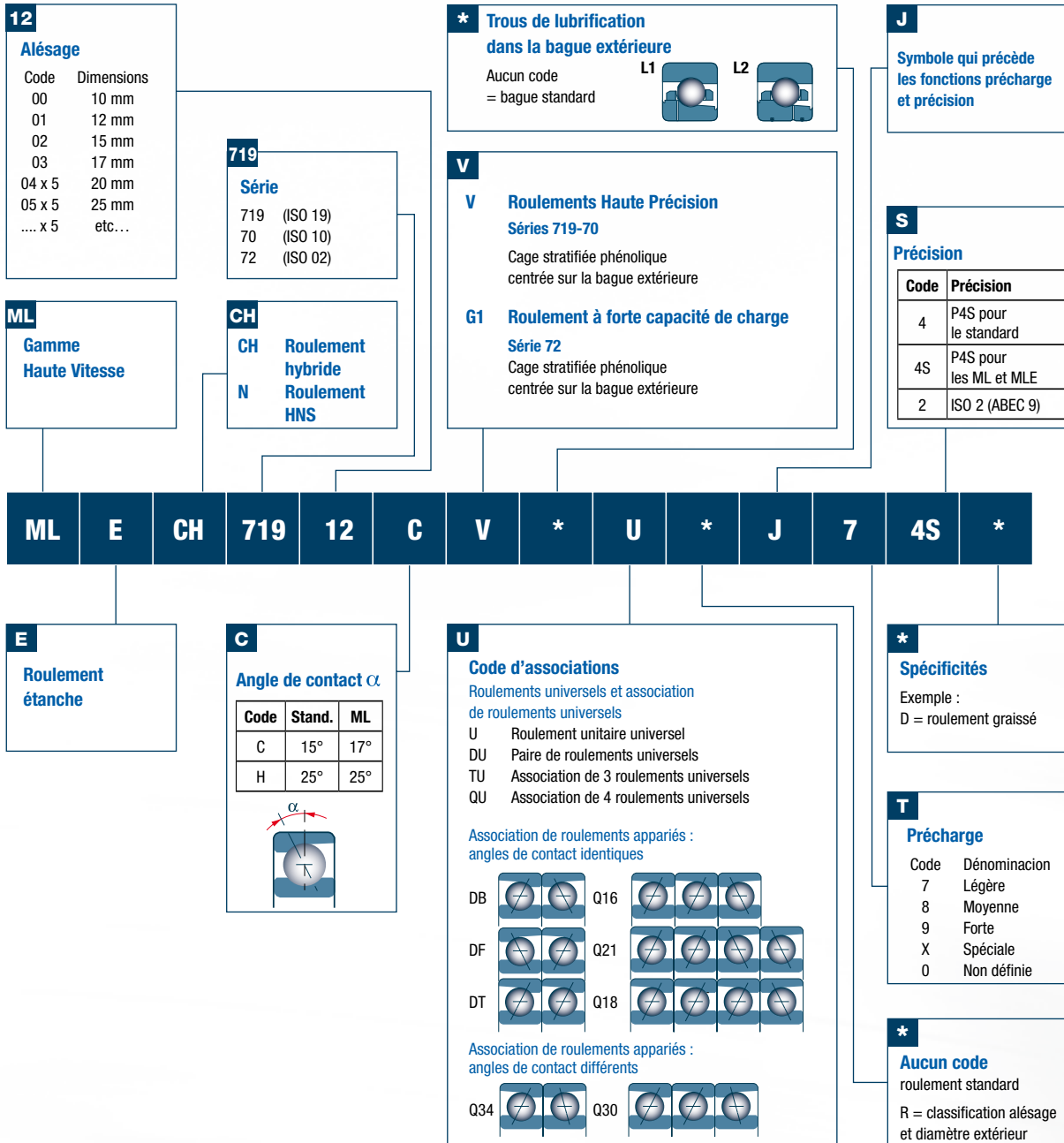

Bezeichnung der NTN Wälzlager

Baureihe BNT

5S- 7 0 20 U AD T1 DB /GL P4

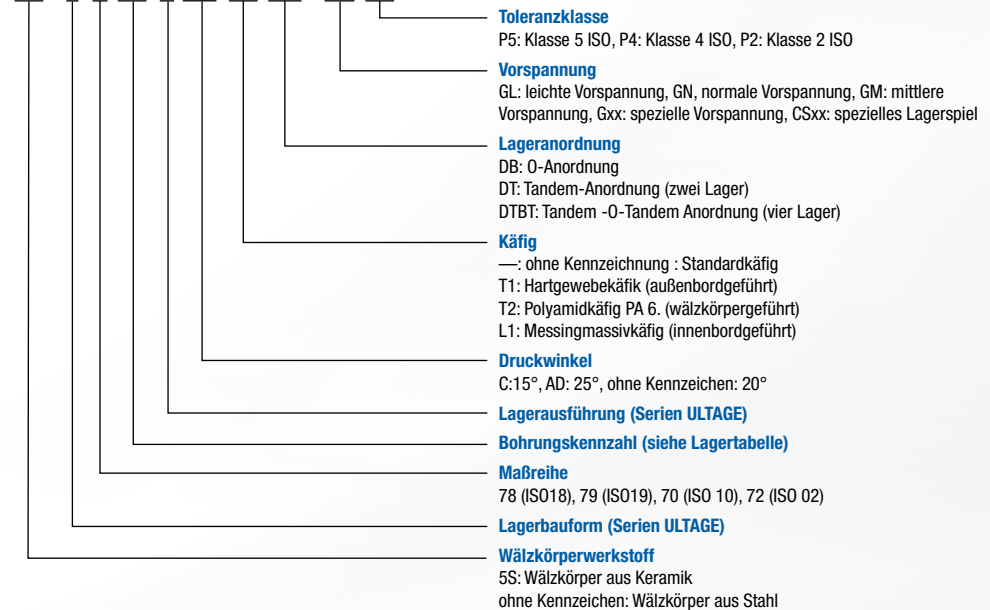

Baureihe HSE

5S- 2LA-HSE 0 20 AD DB /GL P4



Baureihe HSL

5S- 2LA-HSL 0 20 DB +xx Dn /GL P4 +TKZ

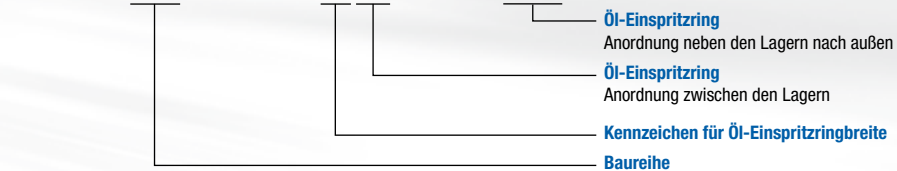

(Anmerkungen): HSL: Baureihe
xxDn: umweltorientierter Öl-Einspritzring, der zwischen den Lagern angeordnet wird (für die Typen HSL)
TKZ: umweltorientierter Öl-Einspritzring, der außen neben den Lagern angeordnet wird (für die Typen HSL)

Baureihe 79LLB/70LLB

5S- 7006 CD LLB DB /GL P42 /L448

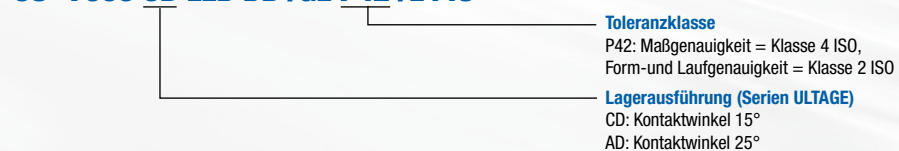

Baureihe BNS

5S- 2LA-BNS 0 20 LLB DB /GL P4 /L448

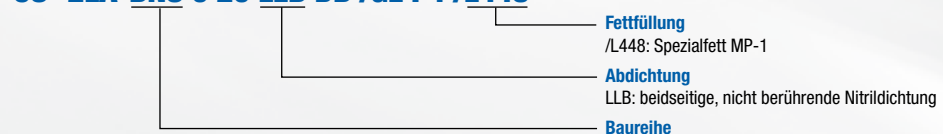

Bezeichnung der SNR Wälzlager

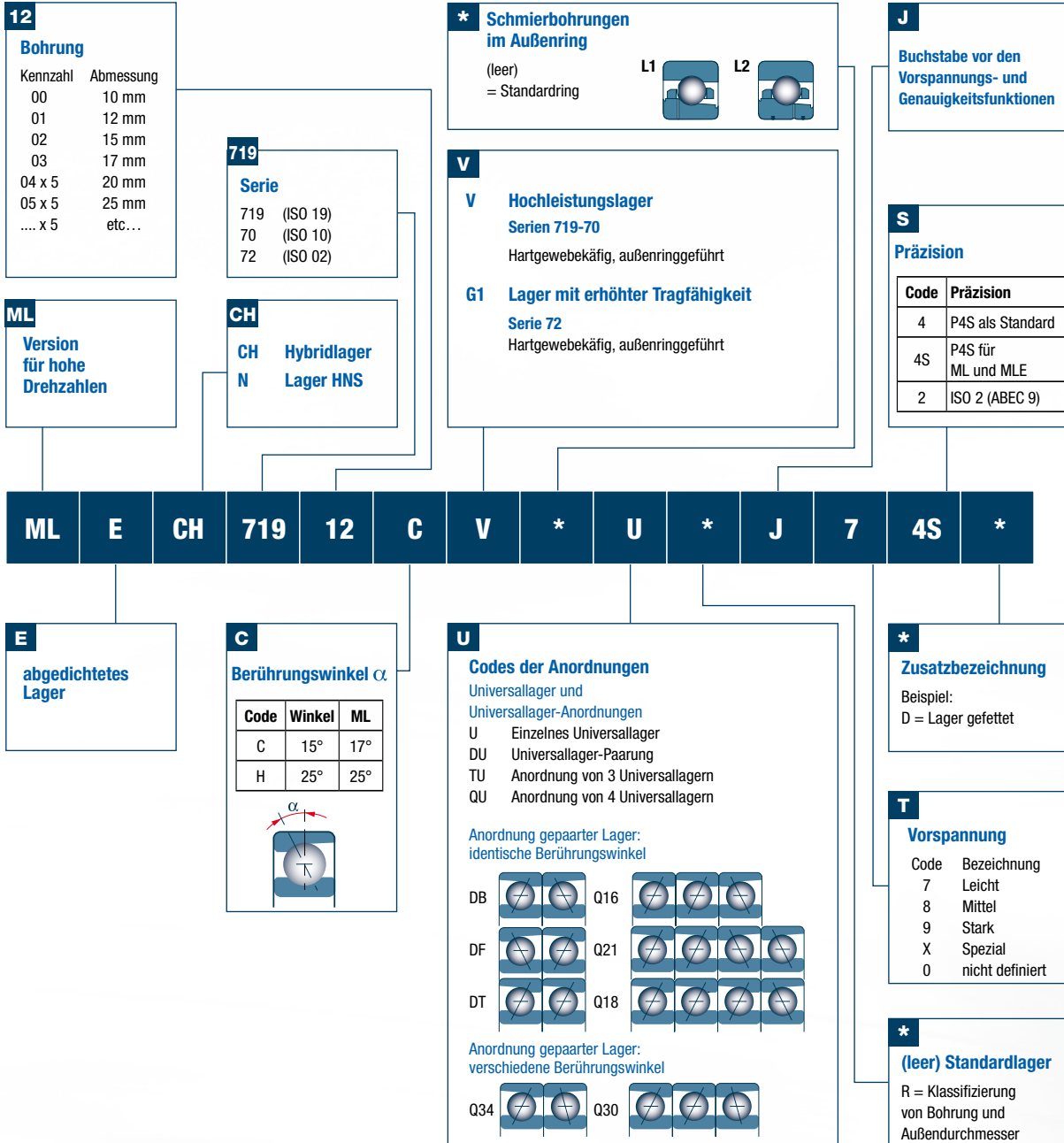

Designazione cuscinetti NTN

Serie 78, 79, 70, 72, BNT

5S- 7 0 20 U AD T1 DB /GL P4

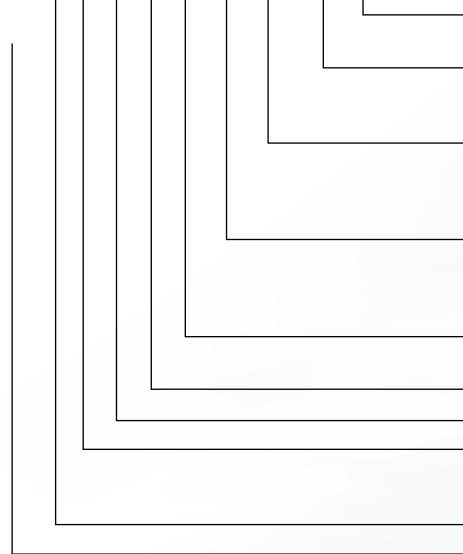

Classe di precisione

P5: classe 5, P4: classe 4, P2: classe 2 (norme ISO)

Classe di gioco/precarico interno

GL: Precarico leggero; GN: Precarico normale; GM: Precarico medio; Gxx: Precarico speciale; CSxx: Gioco speciale

Cuscinetto accoppiabile universale

DB: dorso a dorso (due cuscinetti)
DT: tandem (due cuscinetti)
DTBT: doppio dorso a dorso (quattro cuscinetti)

Codice gabbia

—: senza suffisso, gabbia standard
T1: gabbia in resina fenolica
T2: gabbia in poliammide
L1: gabbia massiccia in ottone

Codice angolo di contatto

C:15°, AD: 25°, Nessun simbolo: 20°

Cuscinetto Serie ULTAGE

Codice foro (vedere tabelle dimensionali)

Codice serie dimensionale

78 (ISO18), 79 (ISO19), 70 (ISO 10), 72 (ISO 02)

Cuscinetto a sfere a contatto obliquo

Codice materiale

5S: corpi volventi in ceramica
Nessun codice: acciaio standard per cuscinetti

Serie HSE

5S- 2LA-HSE 0 20 AD DB /GL P4

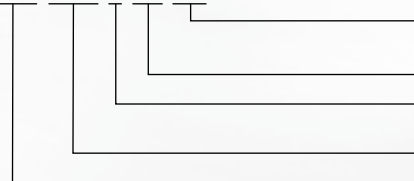

Codice angolo di contatto

C:15°, AD: 25°, Nessun simbolo: 20°

Codice foro (vedere tabelle dimensionali)

HSE 0 (ISO 10) - HSE 9 (ISO 19)

Tipo di cuscinetto

2LA: acciaio speciale con trattamento superficiale migliorativo

Serie HSL

5S- 2LA-HSL 0 20 DB +xx Dn /GL P4 +TKZ



Codice distanziale

Posizionato all'esterno dei cuscinetti

Codice distanziale

Posizionato tra i cuscinetti

Dimensione del distanziale

Tipo di cuscinetto

(note): HSL: tipologia di cuscinetto, Serie HSL

xxDn: Serie Eco-friendly con ugello di lubrificazione, o distanziale tra i cuscinetti Serie Eco-friendly con ugello di lubrificazione (per le Serie HSL)

TKZ: Serie Eco-friendly con ugello di lubrificazione, o distanziale esterno ai cuscinetti Serie Eco-friendly con ugello di lubrificazione (Serie HSL)

Serie 79LLB / 70LLB

5S- 7006 CD LLB DB /GL P42 /L448

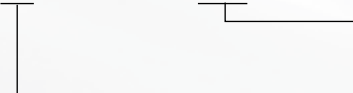

Classe di precisione

P42: precisione dimensionale = Classe 4,
Precisione di rotazione = Classe 2 (norme ISO)

Tipo di cuscinetto (Serie ULTAGE) con tenute

CD: angolo di contatto 15°
AD: angolo di contatto 25°

Serie BNS

5S- 2LA-BNS 0 20 LLB DB /GL P4 /L448



Codice grasso

/L448: Grasso speciale MP-1

Codice tenute

LLB: tenuta in gomma nitrilica non strisciante, sui due lati

Tipo cuscinetto

Designazione cuscinetti SNR

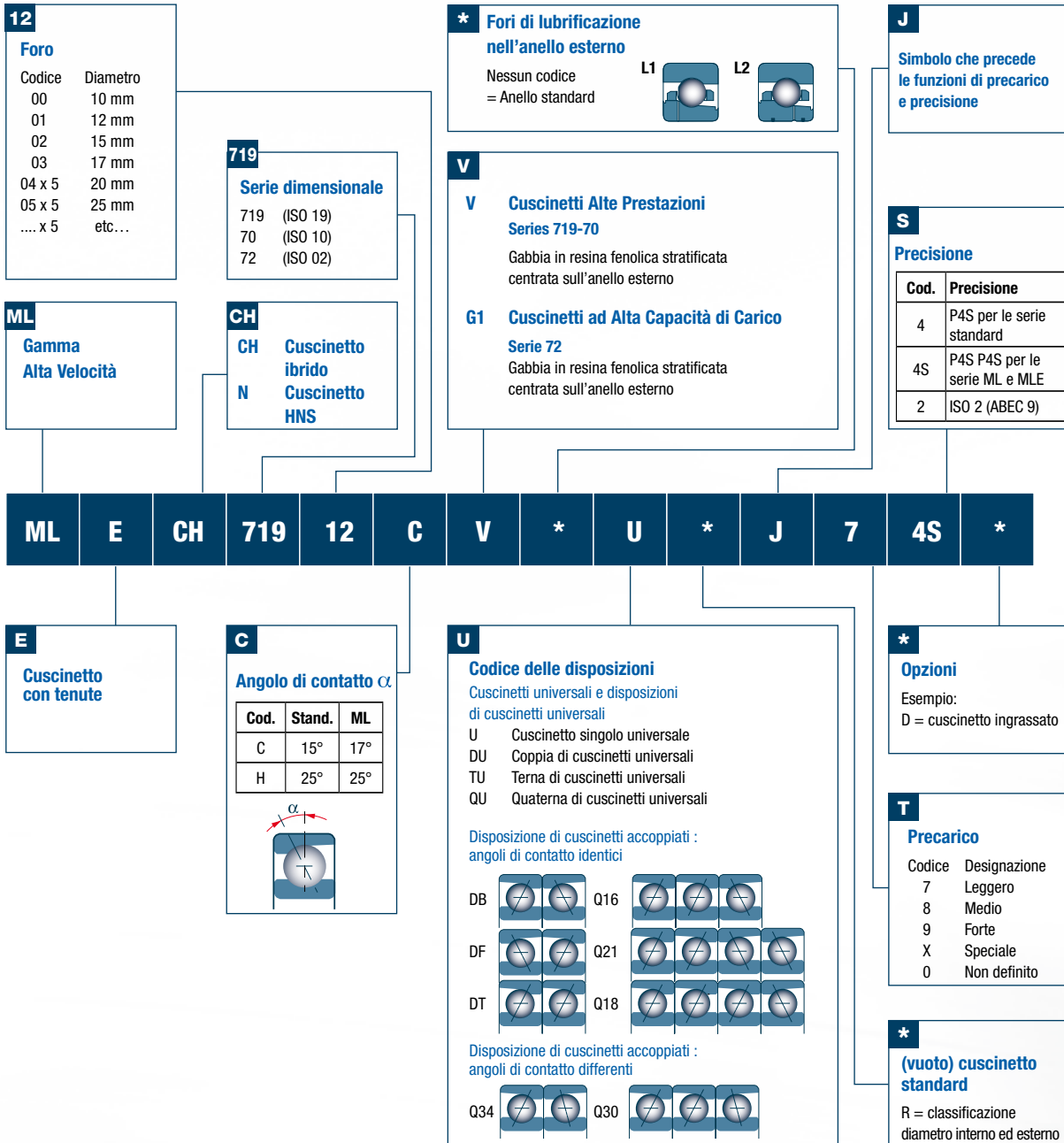

Designaciones de los rodamientos NTN

78, 79, 70, 72, Tipo BNT

5S- 7 0 20 U AD T1 DB /GL P4

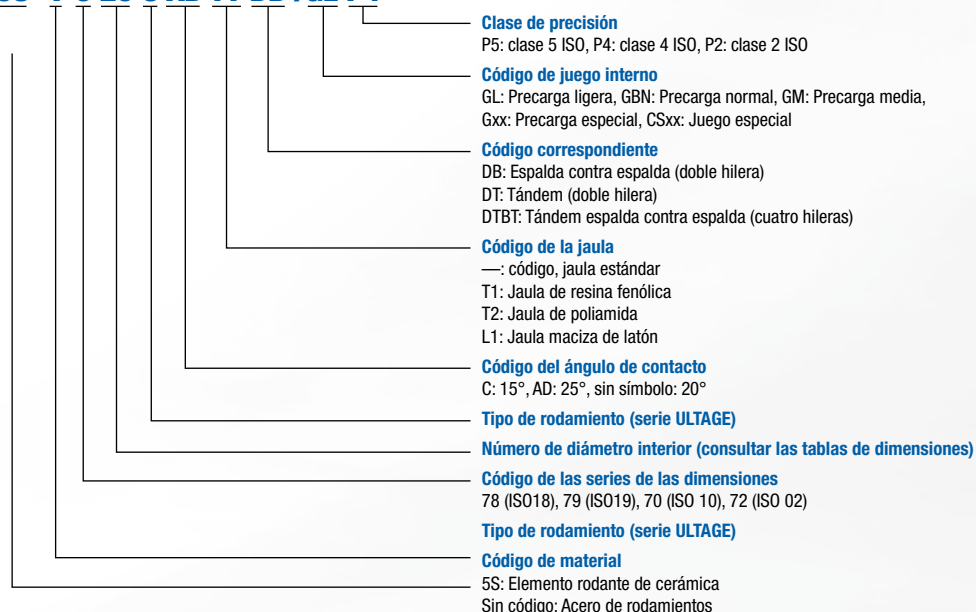

Tipo HSE

5S- 2LA-HSE 0 20 AD DB /GL P4

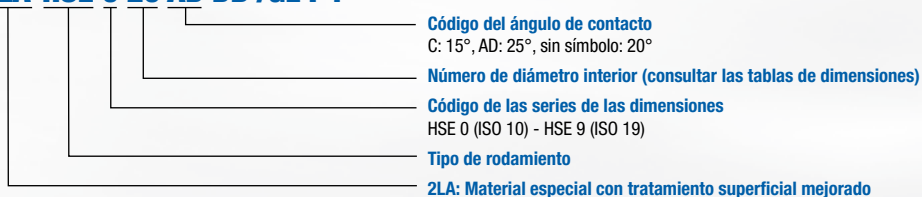

Tipo HSL

5S- 2LA-HSL 0 20 DB +xx Dn /GL P4 +TKZ

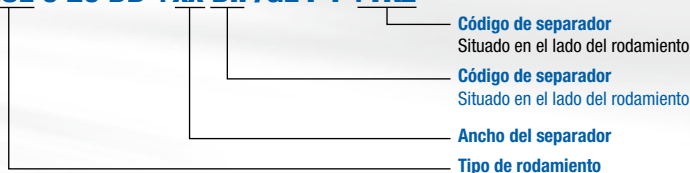

(notas): HSL: Código de las series del rodamiento
xxDn: Boquilla de lubricación eco-responsable, o separador con boquilla de lubricación eco-responsable situada entre los rodamientos (en los tipos HSL)
TKZ: Boquilla de lubricación eco-responsable, o separador con boquilla de lubricación eco-responsable situada al lado de los rodamientos (en los tipos HSL)

Tipo 79LLB / 70LLB

5S- 7006 CD LLB DB /GL P42 /L448

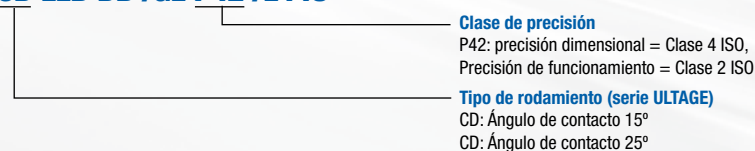

Tipo BNS

5S- 2LA-BNS 0 20 LLB DB /GL P4 /L448

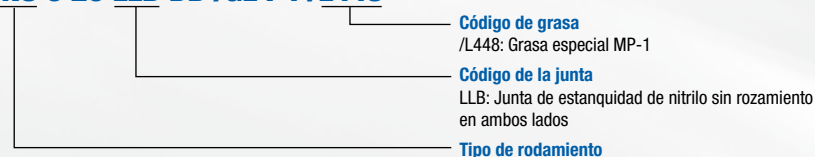

Designaciones de los rodamientos SNR

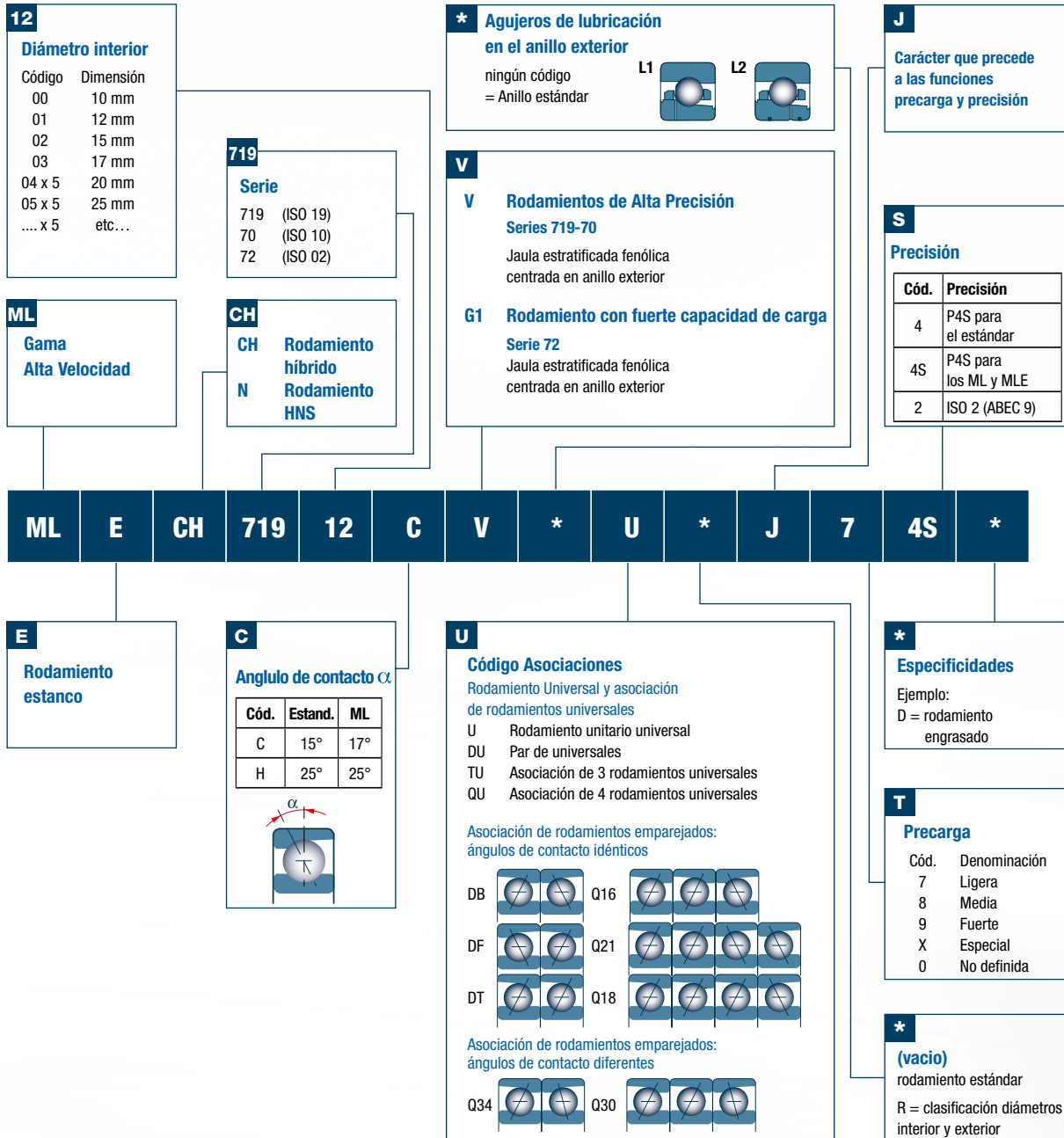

Designação dos rolamentos NTN

78, 79, 70, 72, Tipo BNT

5S- 7 0 20 U AD T1 DB /GL P4

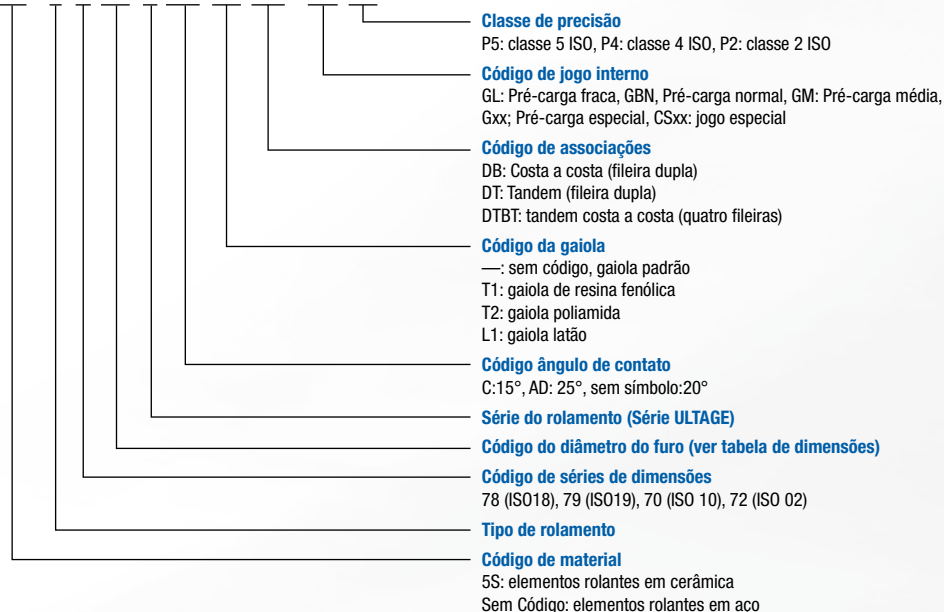

Tipo HSE

5S- 2LA-HSE 0 20 AD DB /GL P4

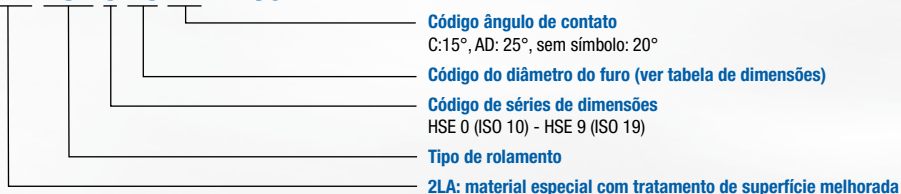

Tipo HSL

5S- 2LA-HSL 0 20 DB +xx Dn /GL P4 +TKZ

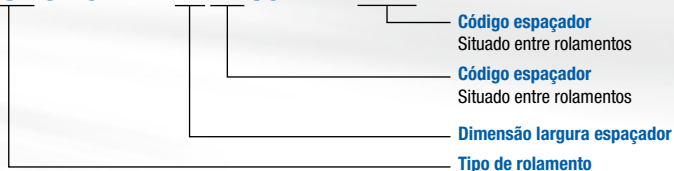

(notas): HSL: Código séries rolamento

xxDn: Bocal de lubrificação ecológico, ou espaçador com bocal de lubrificação ecológico situado entre os rolamentos (para o tipo HSL)

TKZ: Bocal de lubrificação ecológico, ou espaçador com bocal de lubrificação ecológico situado ao lado dos rolamentos (para o tipo HSL)

Tipo 79LLB / 70LLB

5S- 7006 CD LLB DB /GL P42 /L448

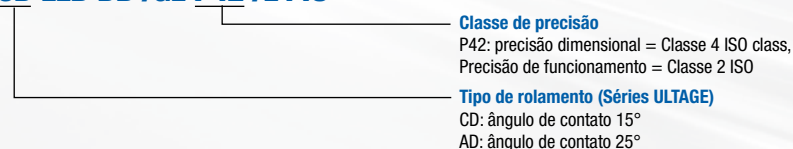

Tipo BNS

5S- 2LA-BNS 0 20 LLB DB /GL P4 /L448

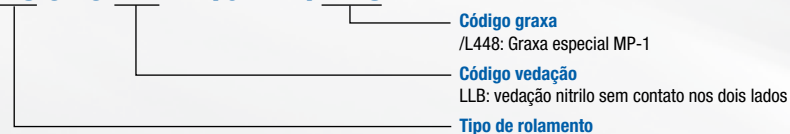

Designação dos rolamentos SNR

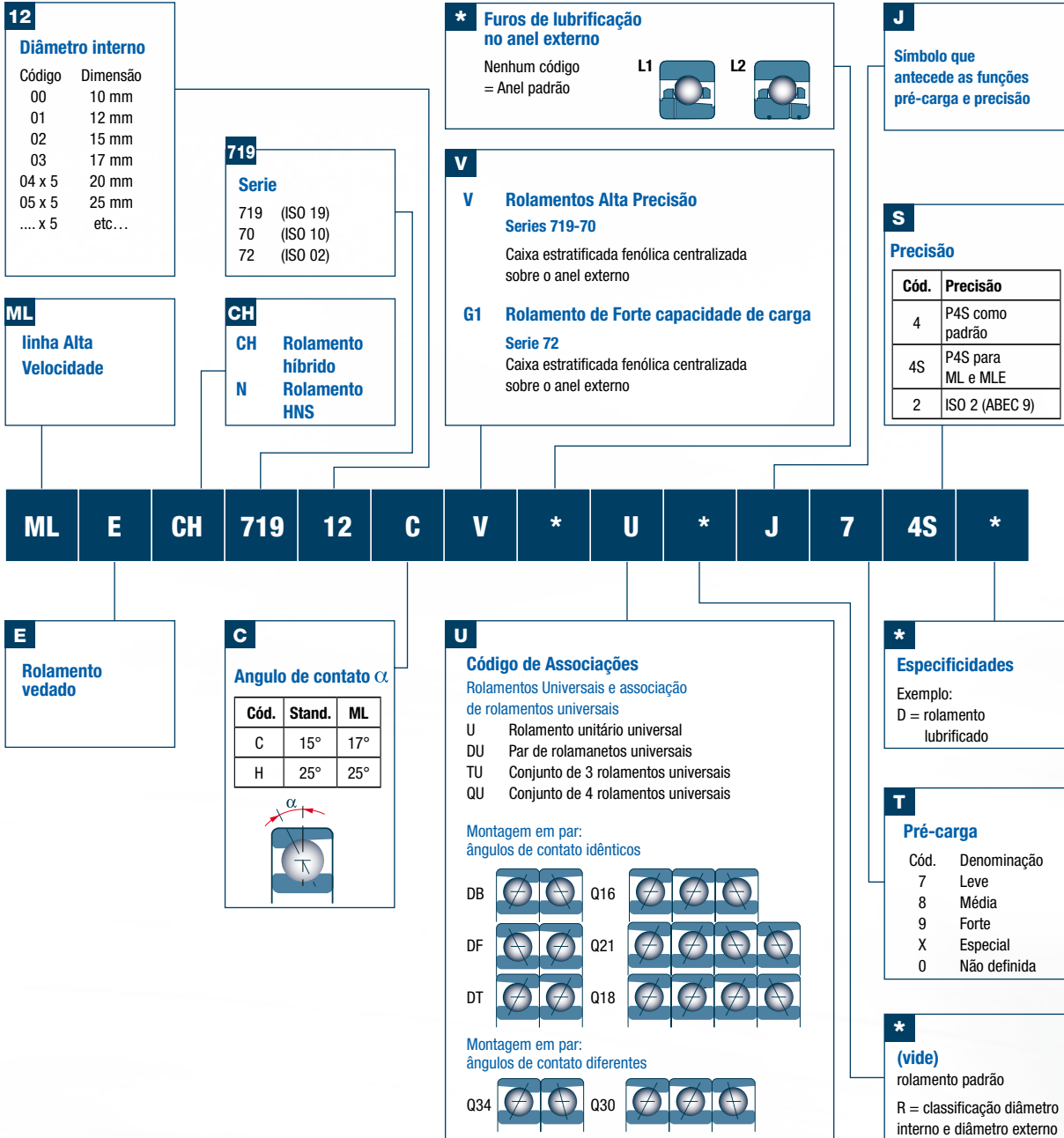



Обозначения подшипников NTN

78, 79, 70, 72, Тип BNT

5S- 7 0 20 U AD T1 DB /GL P4

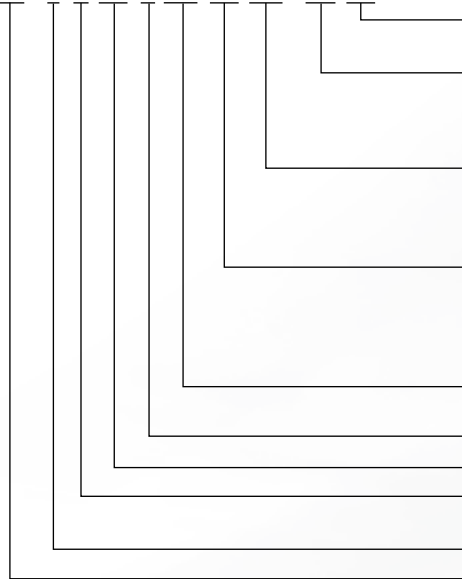

Класс точности

P5: класс 5 ISO, P4: класс 4 ISO, P2: класс 2 ISO

Код внутреннего зазора

GL: незначительная предварительная нагрузка, GBN: нормальная предварительная нагрузка, GM: средняя предварительная нагрузка, Gxx: специальная предварительная нагрузка, CSxx: специальный зазор

Код установки в тандем

DB: Установка по схеме 0 (ДВУХРЯДНЫЕ)
DT: Тандем (ДВУХРЯДНЫЕ)
DTBT: Тандем установки по схеме 0 (ЧЕТЫРЕХРЯДНЫЕ)

Код сепаратора

—: нет кода, стандартный сепаратор
T1: сепаратор из фенольной смолы
T2: Полиамидный сепаратор
L1: Массивный латунный сепаратор

Код угла контакта

C: 15°, AD: 25°, отсутствие обозначения: 20°

Тип подшипника (серия ULTAGE)

Код диаметра отверстия (см. таблицу размеров)

Коды размеров серии

78 (ISO18), 79 (ISO19), 70 (ISO 10), 72 (ISO 02)

Тип подшипника (серия ULTAGE)

Код материала

5S: керамическое тело качения
Без кода: Подшипниковая сталь

Тип HSE

5S- 2LA-HSE 0 20 AD DB /GL P4

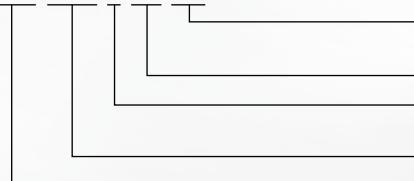

Код угла контакта

C: 15°, AD: 25°, Без символа: 20°

Код диаметра отверстия (см. таблицу размеров)

Коды размеров серии
HSE 0 (ISO 10) - HSE 9 (ISO 19)

Тип подшипника

2LA: Специальный материал с поверхностным упрочнением

Тип HSL

5S- 2LA-HSL 0 20 DB +xx Dn /GL P4 +TKZ

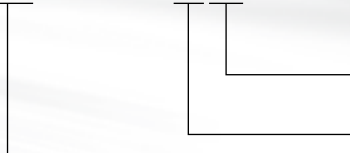

Код кольца

Расположено сбоку подшипников

Код кольца

Расположено между подшипниками

Ширина кольца

Тип подшипника

(примечания): HSL: код серии подшипника

xxDn: Экологичное смазочное устройство или кольцо с экологичным смазочным устройством между подшипниками (для типов HSL)

TKZ: Экологичное смазочное устройство или кольцо с экологичным смазочным устройством сбоку подшипников (для типов HSL)

Тип 79LLB / 70LLB

5S- 7006 CD LLB DB /GL P42 /L448

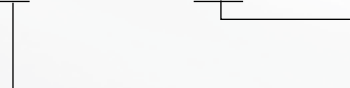

Класс точности

P42: точность размеров = класс 4 ISO,
точность вращения = класс 2 ISO

Тип подшипника (серия ULTAGE)

CD: Угол контакта 15 °

AD: Угол контакта 25 °

Тип BNS

5S- 2LA-BNS 0 20 LLB DB /GL P4 /L448

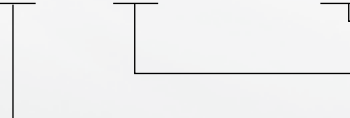

Код смазки

/L448: Специальная смазка MP-1

Код уплотнения

LLB: бесконтактное резиновое уплотнение с двух сторон

Тип подшипника

Обозначения подшипников SNR

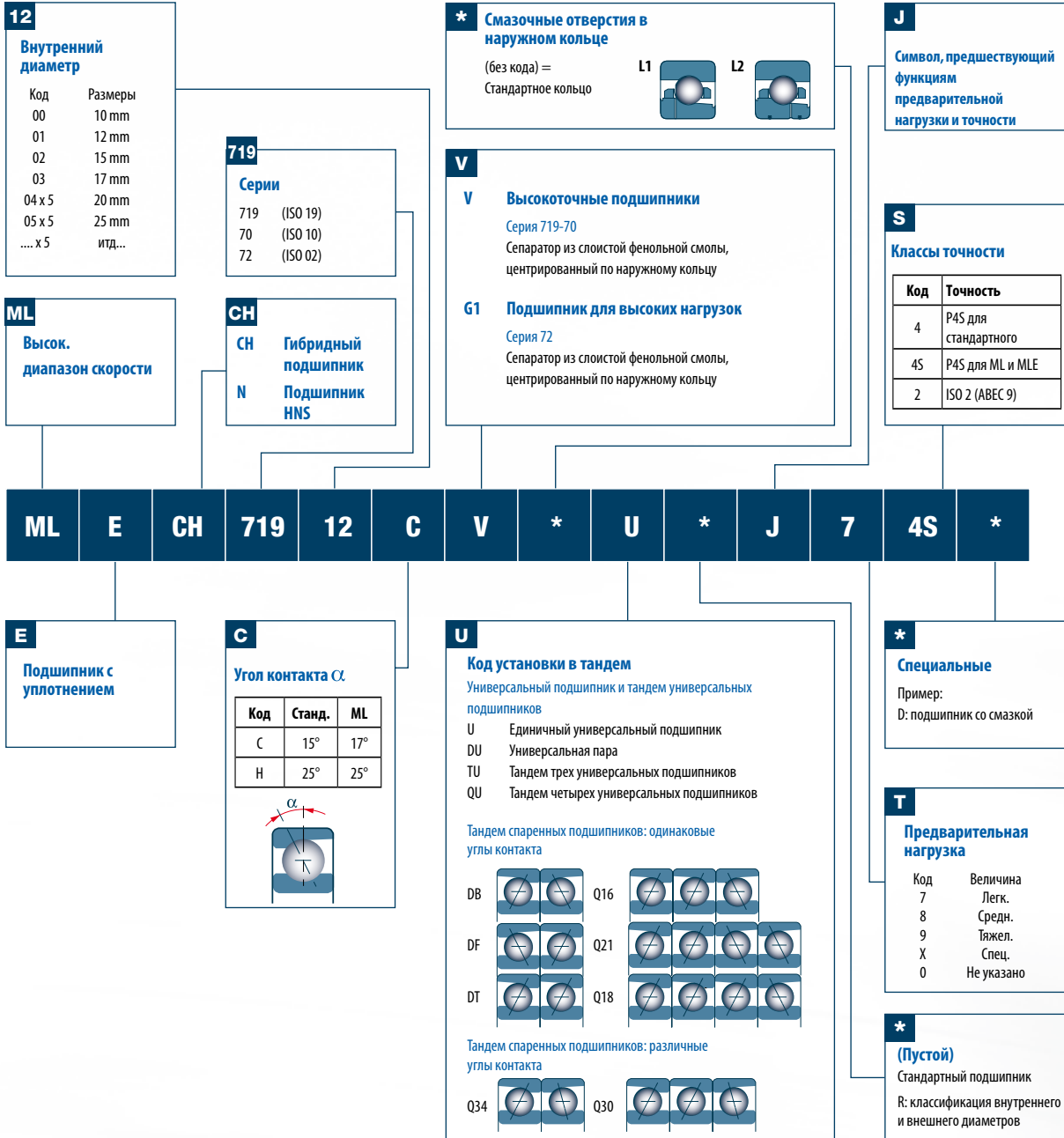

Oznaczenia łożysk NTN

78, 79, 70, 72, Typ BNT

5S- 7 0 20 U AD T1 DB /GL P4

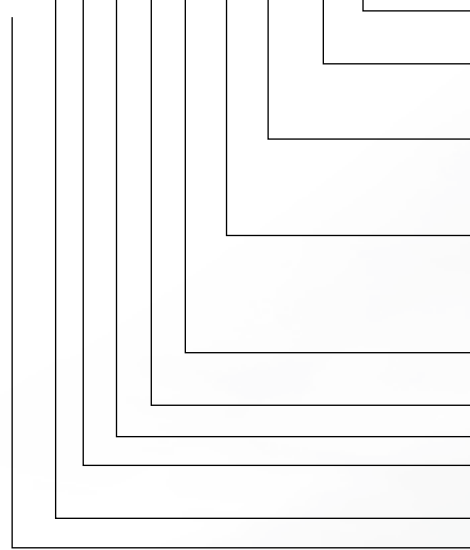

- Klasa dokładności**
P5: klasa 5 wg ISO, P4: klasa 4 wg ISO, P2: klasa 2 wg ISO
- Kod napięcia wstępnego**
GL: niskie napięcie wstępne, GBN, normalne napięcie wstępne, GM: średnie napięcie wstępne, Gxx; napięcie wstępne specjalne, CSxx: luz specjalny
- Kod zabudowy**
DB: układ 0 (dwurzędowe)
DT: tandem (dwurzędowe)
DTBT: układ tandem 0 (czterorzędowe)
- Kod koszyka**
—: brak kodu, koszyk standardowy
T1: koszyk z żywicy fenolowej
T2: koszyk z poliamidu
L1: koszyk masywny mosiężny
- Kod kąta działania**
C: 15°, AD: 25°, brak symbolu: 20°
- Typ łożyska (seria ULTAGE)**
- Oznaczenie średnicy otworu (patrz tabele wymiarów)**
- Kod serii wymiarowej**
78 (ISO 18), 79 (ISO 19), 70 (ISO 10), 72 (ISO 02)
- Typ łożyska**
- Kod materiału**
5S: element toczny ceramiczny
Brak kodu: stal łożyskowa

Typ HSE

5S- 2LA-HSE 0 20 AD DB /GL P4

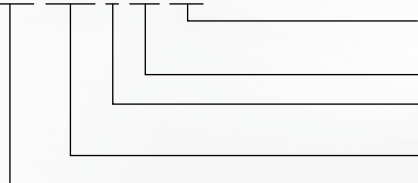

- Kod kąta działania**
C: 15°, AD: 25°, brak symbolu: 20°
- Numer średnicy otworu (patrz tabele wymiarów)**
- Kod serii wymiarowej**
HSE 0 (ISO 10) - HSE 9 (ISO 19)
- Typ łożyska**
2LA: materiał specjalny o ulepszonej obróbce powierzchniowej

Typ HSL

5S- 2LA-HSL 0 20 DB +xx Dn /GL P4 +TKZ

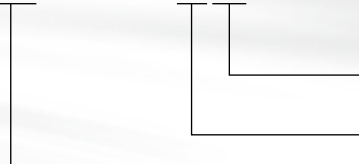

- Kod podkładki**
Umieszczony na boku łożyska
- Kod podkładki**
Umieszczony na boku łożyska
- Wymiar szerokości podkładki**
- Typ łożyska**

(uwagi): HSL: kod serii łożyska

xxDn: ekologiczna dysza smarująca lub podkładka z ekologiczną dyszą smarującą umieszczona pomiędzy łożyskami (dla typu HSL)

TKZ: ekologiczna dysza smarująca lub podkładka z ekologiczną dyszą smarującą umieszczona z boku łożyska (dla typu HSL)

Typ 79LLB / 70LLB

5S- 7006 CD LLB DB /GL P42 /L448

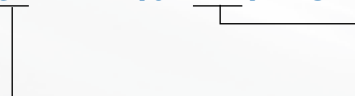

- Klasa dokładności**
P42: dokładność wymiarowa = klasa 4 wg ISO
dokładność bicia = klasa 2 wg ISO
- Typ łożyska (seria ULTAGE)**
CD: kąt działania 15°
AD: kąt działania 25°

Typ BNS

5S- 2LA-BNS 0 20 LLB DB /GL P4 /L448



- Kod smaru**
/L448: Smar specjalny MP-1
- Kod uszczelnienia**
LLB: bezkontaktowa uszczelka gumowa z obu stron
- Typ łożyska**

Oznaczenia łożysk SNR

12
Średnica otworu

Kod	Wymiary
00	10 mm
01	12 mm
02	15 mm
03	17 mm
04 x 5	20 mm
05 x 5	25 mm
... x 5	etc...

719
Seria

719	(ISO 19)
70	(ISO 10)
72	(ISO 02)

ML
łożysko do dużych prędkości obrotowych

CH
CH łożysko hybrydowe
N łożysko HNS

***** **Otworki do smarowania na pierścieniu zewnętrznym**
(brak kodu) = pierścień standardowy

V
łożyska precyzyjne na pierścieniu zewnętrznym
Seria 719-70
Kosz fenolowy warstwowy prowadzony na pierścieniu zewnętrznym

G1 **łożyska o wysokiej nośności**
Seria 72
Kosz fenolowy warstwowy prowadzony na pierścieniu zewnętrznym

J
Symbol poprzedzający napięcie wstępne i dokładność

S
Klasy tolerancji

Kod	Dokładność
4	P4S dla standardowych
4S	P4S dla ML i MLE
2	ISO 2 (ABEC 9)

ML E CH 719 12 C V * U * J 7 4S *

E
łożysko uszczelnione

C
Kąt działania α

Kod	Stand.	ML
C	15°	17°
H	25°	25°

U
Kod zabudowy
łożysko uniwersalne i układ zabudowy łożysk uniwersalnych

- U łożysko uniwersalne pojedyncze
- DU Parowanie uniwersalne
- TU Układ 3 łożysk uniwersalnych
- QU Układ 4 łożysk uniwersalnych

Układ par łożysk: identyczne kąty działania

DB		Q16	
DF		Q21	
DT		Q18	

Układ par łożysk: różne kąty działania

Q34		Q30	
-----	--	-----	--

Specjalne
Przykład:
D= łożysko nasmarowane

T
Napięcie wstępne

Kod	Napięcie
7	Lekkie
8	Średnie
9	Duże
X	Specjalne
0	Nieokreślone

Puste
łożysko standardowe
R= klasyfikacja średnicy wewnętrznej i zewnętrznej

Reference	d	D	B	Kg	?	Brands
70M6DB/GMP5	6,000	17,000	12,000	0,012	2	NTN
70M6DF/GMP5	6,000	17,000	12,000	0,012	2	NTN
70M8DF/GMP5	8,000	22,000	14,000	0,013	2	NTN
5S-7000ADLLBG/GNP42	10,000	26,000	8,000	0,014	2	NTN
5S-7000CDLLBG/GNP42	10,000	26,000	8,000	0,014	2	NTN
5S-7000UADG/GNP42	10,000	26,000	8,000	0,014	2	NTN
5S-7000UCG/GNP42	10,000	26,000	8,000	0,014	2	NTN
7000ADLLBG/GNP42	10,000	26,000	8,000	0,019	2	NTN
7000CDLLBG/GNP42	10,000	26,000	8,000	0,019	2	NTN
7000CG/GLP4	10,000	26,000	8,000	0,019	2	NTN
7000CG/GMP42	10,000	26,000	8,000	0,019	2	NTN
7000CG/GNP4	10,000	26,000	8,000	0,019	2	NTN
7000CG/GNP42	10,000	26,000	8,000	0,019	2	NTN
7000CGD2/GNP4	10,000	26,000	8,000	0,019	2	NTN
7000G/GMP42/L606Q2	10,000	26,000	8,000	0,019	2	NTN
7000UADG/GNP42	10,000	26,000	8,000	0,019	2	NTN
7000UCG/GNP4	10,000	26,000	8,000	0,019	2	NTN
7000UCG/GNP42	10,000	26,000	8,000	0,019	2	NTN
7000UG/GMP42/L606Q2	10,000	26,000	8,000	0,019	2	NTN
7000CVUJ74	10,000	26,000	8,000	0,024	2	SNR
7000HVUJ74	10,000	26,000	8,000	0,023	2	SNR
ML7000CVUJ74S	10,000	26,000	8,000	0,026	2	SNR
ML7000HVUJ74S	10,000	26,000	8,000	0,026	2	SNR
MLE7000CVUJ74S	10,000	26,000	8,000	0,024	2	SNR
MLE7000HVUJ74S	10,000	26,000	8,000	0,026	2	SNR
7000CVDUJ74	10,000	26,000	16,000	0,044	2	SNR
7000HVDUJ74	10,000	26,000	16,000	0,045	2	SNR
ML7000CVDUJ74S	10,000	26,000	16,000	0,040	2	SNR
ML7000HVDUJ74S	10,000	26,000	16,000	0,040	2	SNR
MLE7000CVDUJ74S	10,000	26,000	16,000	0,046	2	SNR
MLE7000HVDUJ74S	10,000	26,000	16,000	0,040	2	SNR
5S-7001ADLLBG/GNP42	12,000	28,000	8,000	0,020	2	NTN
5S-7001CDLLBG/GNP42	12,000	28,000	8,000	0,020	2	NTN
5S-7001UADG/GNP42	12,000	28,000	8,000	0,020	2	NTN
5S-7001UCG/GNP42	12,000	28,000	8,000	0,020	2	NTN
7001ADLLBG/GNP42	12,000	28,000	8,000	0,021	2	NTN
7001CDLLBG/GNP42	12,000	28,000	8,000	0,021	2	NTN
7001CG/GMP42	12,000	28,000	8,000	0,021	2	NTN
7001CG/GNP4	12,000	28,000	8,000	0,021	2	NTN
7001CG/GNP42	12,000	28,000	8,000	0,021	2	NTN
7001G/GMP4	12,000	28,000	8,000	0,021	2	NTN
7001G/GMP42/L606Q2	12,000	28,000	8,000	0,021	2	NTN
7001UADG/GNP42	12,000	28,000	8,000	0,021	2	NTN
7001UCG/GNP4	12,000	28,000	8,000	0,021	2	NTN
7001UCG/GNP42	12,000	28,000	8,000	0,021	2	NTN
7001UCGD2/GNP4	12,000	28,000	8,000	0,021	2	NTN
7001UG/GMP42/L606Q2	12,000	28,000	8,000	0,021	2	NTN
7001CVUJ74	12,000	28,000	8,000	0,025	2	SNR
7001HVUJ74	12,000	28,000	8,000	0,030	2	SNR
ML7001CVUJ74S	12,000	28,000	8,000	0,032	2	SNR
ML7001HVUJ74S	12,000	28,000	8,000	0,208	2	SNR
MLE7001CVUJ74S	12,000	28,000	8,000	0,020	2	SNR
MLE7001HVUJ74S	12,000	28,000	8,000	0,028	2	SNR

Reference	d	D	B	Kg	?	Brands
7001CDB/GNP5	12,000	28,000	16,000	0,042	2	NTN
7001DF	12,000	28,000	16,000	0,042	2	NTN
7001HTDF/GMP5	12,000	28,000	16,000	0,042	2	NTN
7001UCDB/GNP5	12,000	28,000	16,000	0,042	2	NTN
7001CVDUJ74	12,000	28,000	16,000	0,050	2	SNR
7001HVDUJ74	12,000	28,000	16,000	0,049	2	SNR
ML7001CVDUJ74S	12,000	28,000	16,000	0,051	2	SNR
ML7001HVDUJ74S	12,000	28,000	16,000	0,048	2	SNR
MLE7001CVDUJ74S	12,000	28,000	16,000	0,052	2	SNR
MLE7001HVDUJ74S	12,000	28,000	16,000	0,048	2	SNR
5S-7002ADLLBG/GNP42	15,000	32,000	9,000	0,029	2	NTN
5S-7002CDLLBG/GNP42	15,000	32,000	9,000	0,029	2	NTN
5S-7002UADG/GNP42	15,000	32,000	9,000	0,029	2	NTN
5S-7002UCG/GNP42	15,000	32,000	9,000	0,029	2	NTN
7002ADLLBG/GNP42	15,000	32,000	9,000	0,030	2	NTN
7002CDLLBG/GNP42	15,000	32,000	9,000	0,030	2	NTN
7002CG/GMP42	15,000	32,000	9,000	0,030	2	NTN
7002CG/GNP4	15,000	32,000	9,000	0,030	2	NTN
7002CG/GNP42	15,000	32,000	9,000	0,030	2	NTN
7002CGD2/GNP4	15,000	32,000	9,000	0,030	2	NTN
7002G/GMP4	15,000	32,000	9,000	0,030	2	NTN
7002G/GMP4/15KQTQ	15,000	32,000	9,000	0,030	2	NTN
7002G/GMP42/L606QTM	15,000	32,000	9,000	0,030	2	NTN
7002G/GNP4	15,000	32,000	9,000	0,030	2	NTN
7002UADG/GNP42	15,000	32,000	9,000	0,030	2	NTN
7002UCG/GNP4	15,000	32,000	9,000	0,030	2	NTN
7002UCG/GNP42	15,000	32,000	9,000	0,030	2	NTN
7002UCGD2/GLP4	15,000	32,000	9,000	0,030	2	NTN
7002CVUJ74	15,000	32,000	9,000	0,034	2	SNR
7002HVUJ74	15,000	32,000	9,000	0,034	2	SNR
ML7002CVUJ74S	15,000	32,000	9,000	0,035	2	SNR
ML7002HVUJ74S	15,000	32,000	9,000	0,035	2	SNR
MLE7002CVUJ74S	15,000	32,000	9,000	0,032	2	SNR
MLE7002HVUJ74S	15,000	32,000	9,000	0,036	2	SNR
7002CDF/GNP4	15,000	32,000	18,000	0,060	2	NTN
7002HTDF/GMP5	15,000	32,000	18,000	0,060	2	NTN
7002CVDUJ74	15,000	32,000	18,000	0,066	2	SNR
7002HVDUJ74	15,000	32,000	18,000	0,067	2	SNR
ML7002CVDUJ74S	15,000	32,000	18,000	0,066	2	SNR
ML7002HVDUJ74S	15,000	32,000	18,000	0,064	2	SNR
MLE7002CVDUJ74S	15,000	32,000	18,000	0,068	2	SNR
MLE7002HVDUJ74S	15,000	32,000	18,000	0,064	2	SNR
2LA-HSE003ADG/GNP42	15,000	35,000	10,000	0,037	2	NTN
2LA-HSE003CG/GNP42	15,000	35,000	10,000	0,037	2	NTN
5S-2LA-HSE003ADG/GNP42	15,000	35,000	10,000	0,037	2	NTN
5S-2LA-HSE003CG/GNP42	15,000	35,000	10,000	0,037	2	NTN
5S-7003ADLLBG/GNP42	17,000	35,000	10,000	0,035	2	NTN
5S-7003CDLLBG/GNP42	17,000	35,000	10,000	0,035	2	NTN
5S-7003UADG/GNP42	17,000	35,000	10,000	0,035	2	NTN
5S-7003UCG/GNP42	17,000	35,000	10,000	0,035	2	NTN
7003ADLLBG/GNP42	17,000	35,000	10,000	0,037	2	NTN
7003CDLLBG/GNP42	17,000	35,000	10,000	0,037	2	NTN
7003G/GMP4	17,000	35,000	10,000	0,037	2	NTN

Reference	d	D	B	Kg		Brands
7003UADG/GNP42	17,000	35,000	10,000	0,037	2	NTN
7003UCG/GMP42	17,000	35,000	10,000	0,037	2	NTN
7003UCG/GNP4	17,000	35,000	10,000	0,037	2	NTN
7003UCG/GNP42	17,000	35,000	10,000	0,037	2	NTN
7003UCGD2/GLP4	17,000	35,000	10,000	0,037	2	NTN
7003UG/GMP42/L606Q1	17,000	35,000	10,000	0,037	2	NTN
7003UG/GNP4	17,000	35,000	10,000	0,037	2	NTN
7003CVUJ74	17,000	35,000	10,000	0,043	2	SNR
7003HVUJ74	17,000	35,000	10,000	0,047	2	SNR
ML7003CVUJ74S	17,000	35,000	10,000	0,044	2	SNR
ML7003HVUJ74S	17,000	35,000	10,000	0,046	2	SNR
MLE7003CVUJ74S	17,000	35,000	10,000	0,045	2	SNR
MLE7003HVUJ74S	17,000	35,000	10,000	0,048	2	SNR
7003CVDUJ74	17,000	35,000	20,000	0,086	2	SNR
7003HVDUJ74	17,000	35,000	20,000	0,085	2	SNR
ML7003CVDUJ74S	17,000	35,000	20,000	0,084	2	SNR
ML7003HVDUJ74S	17,000	35,000	20,000	0,080	2	SNR
MLE7003CVDUJ74S	17,000	35,000	20,000	0,088	2	SNR
MLE7003HVDUJ74S	17,000	35,000	20,000	0,080	2	SNR
2LA-HSE004ADG/GNP42	20,000	42,000	12,000	0,067	2	NTN
2LA-HSE004CG/GNP42	20,000	42,000	12,000	0,067	2	NTN
5S-2LA-HSE004ADG/GNP42	20,000	42,000	12,000	0,067	2	NTN
5S-2LA-HSE004CG/GNP42	20,000	42,000	12,000	0,067	2	NTN
5S-7004ADLLBG/GNP42	20,000	42,000	12,000	0,064	2	NTN
5S-7004CDLLBG/GNP42	20,000	42,000	12,000	0,064	2	NTN
5S-7004UADG/GNP42	20,000	42,000	12,000	0,064	2	NTN
5S-7004UCG/GNP42	20,000	42,000	12,000	0,064	2	NTN
7004ADLLBG/GNP42	20,000	42,000	12,000	0,067	2	NTN
7004CDLLBG/GNP42	20,000	42,000	12,000	0,067	2	NTN
7004CG/GNP42	20,000	42,000	12,000	0,067	2	NTN
7004G/GNP4	20,000	42,000	12,000	0,067	2	NTN
7004UADG/GNP42	20,000	42,000	12,000	0,067	2	NTN
7004UCG/GNP4	20,000	42,000	12,000	0,067	2	NTN
7004UCG/GNP42	20,000	42,000	12,000	0,067	2	NTN
7004UCGD2/GLP4	20,000	42,000	12,000	0,067	2	NTN
7004UG/GHP5	20,000	42,000	12,000	0,067	2	NTN
7004UG/GMP4	20,000	42,000	12,000	0,067	2	NTN
7004UG/GMP4/15KQTQ	20,000	42,000	12,000	0,067	2	NTN
7004UG/GNP4	20,000	42,000	12,000	0,067	2	NTN
7004CVUJ74	20,000	42,000	12,000	0,070	2	SNR
7004HVUJ74	20,000	42,000	12,000	0,072	2	SNR
ML7004CVUJ74S	20,000	42,000	12,000	0,069	2	SNR
ML7004HVUJ74S	20,000	42,000	12,000	0,070	2	SNR
MLE7004CVUJ74S	20,000	42,000	12,000	0,074	2	SNR
MLE7004HVUJ74S	20,000	42,000	12,000	0,074	2	SNR
7004CVDUJ74	20,000	42,000	24,000	0,145	2	SNR
7004HVDUJ74	20,000	42,000	24,000	0,144	2	SNR
ML7004CVDUJ74S	20,000	42,000	24,000	0,138	2	SNR
ML7004HVDUJ74S	20,000	42,000	24,000	0,140	2	SNR
MLE7004CVDUJ74S	20,000	42,000	24,000	0,144	2	SNR
MLE7004HVDUJ74S	20,000	42,000	24,000	0,140	2	SNR
2LA-HSE005ADG/GNP42	25,000	47,000	12,000	0,079	2	NTN

Reference	d	D	B	Kg		Brands
2LA-HSE005CG/GNP42	25,000	47,000	12,000	0,079	2	NTN
5S-2LA-HSE005ADG/GNP42	25,000	47,000	12,000	0,079	2	NTN
5S-2LA-HSE005CG/GNP42	25,000	47,000	12,000	0,079	2	NTN
5S-7005ADLLBG/GNP42	25,000	47,000	12,000	0,075	2	NTN
5S-7005CDLLBG/GNP42	25,000	47,000	12,000	0,075	2	NTN
5S-7005UADG/GNP42	25,000	47,000	12,000	0,075	2	NTN
5S-7005UCG/GNP42	25,000	47,000	12,000	0,075	2	NTN
7005ADLLBG/GNP42	25,000	47,000	12,000	0,079	2	NTN
7005CDLLBG/GNP42	25,000	47,000	12,000	0,079	2	NTN
7005CG/GMP4	25,000	47,000	12,000	0,079	2	NTN
7005UADG/GNP42	25,000	47,000	12,000	0,079	2	NTN
7005UCG/GLP4	25,000	47,000	12,000	0,079	2	NTN
7005UCG/GNP4	25,000	47,000	12,000	0,079	2	NTN
7005UCG/GNP42	25,000	47,000	12,000	0,079	2	NTN
7005UCGD2/GLP4	25,000	47,000	12,000	0,079	2	NTN
7005UCP5	25,000	47,000	12,000	0,079	2	NTN
7005UG/GLP4	25,000	47,000	12,000	0,079	2	NTN
7005UG/GMP4	25,000	47,000	12,000	0,079	2	NTN
7005UG/GMP4/15KQTQ	25,000	47,000	12,000	0,079	2	NTN
7005UG/GNP42	25,000	47,000	12,000	0,079	2	NTN
7005CVUJ74	25,000	47,000	12,000	0,080	2	SNR
7005HVUJ74	25,000	47,000	12,000	0,086	2	SNR
ML7005CVUJ74S	25,000	47,000	12,000	0,082	2	SNR
ML7005HVUJ74S	25,000	47,000	12,000	0,082	2	SNR
MLE7005CVUJ74S	25,000	47,000	12,000	0,084	2	SNR
MLE7005HVUJ74S	25,000	47,000	12,000	0,085	2	SNR
7005CDB/GHP4	25,000	47,000	24,000	0,158	2	NTN
7005CDB/GNP5	25,000	47,000	24,000	0,158	2	NTN
7005UCDF/GMP4	25,000	47,000	24,000	0,158	2	NTN
7005CVDUJ74	25,000	47,000	24,000	0,169	2	SNR
7005HVDUJ74	25,000	47,000	24,000	0,170	2	SNR
ML7005CVDUJ74S	25,000	47,000	24,000	0,160	2	SNR
ML7005HVDUJ74S	25,000	47,000	24,000	0,160	2	SNR
MLE7005CVDUJ74S	25,000	47,000	24,000	0,168	2	SNR
MLE7005HVDUJ74S	25,000	47,000	24,000	0,168	2	SNR
2LA-HSE006ADG/GNP42	30,000	55,000	13,000	0,110	2	NTN
2LA-HSE006CG/GNP42	30,000	55,000	13,000	0,110	2	NTN
5S-2LA-HSE006ADG/GNP42	30,000	55,000	13,000	0,110	2	NTN
5S-2LA-HSE006CG/GNP42	30,000	55,000	13,000	0,110	2	NTN
5S-7006ADLLBG/GNP42	30,000	55,000	13,000	0,096	2	NTN
5S-7006CDLLBG/GNP42	30,000	55,000	13,000	0,096	2	NTN
5S-7006UADG/GNP42	30,000	55,000	13,000	0,096	2	NTN
5S-7006UCG/GNP42	30,000	55,000	13,000	0,096	2	NTN
7006ADLLBG/GNP42	30,000	55,000	13,000	0,110	2	NTN
7006CDLLBG/GNP42	30,000	55,000	13,000	0,110	2	NTN
7006CG/GNP4	30,000	55,000	13,000	0,110	2	NTN
7006UADG/GNP42	30,000	55,000	13,000	0,110	2	NTN
7006UCG/GLP4	30,000	55,000	13,000	0,110	2	NTN
7006UCG/GNP4	30,000	55,000	13,000	0,110	2	NTN
7006UCG/GNP42	30,000	55,000	13,000	0,110	2	NTN
7006UCGD2/GLP4	30,000	55,000	13,000	0,110	2	NTN
7006UG/GMP4	30,000	55,000	13,000	0,110	2	NTN
7006UG/GMP4/15KQTQ	30,000	55,000	13,000	0,110	2	NTN
7006UG/GNP4	30,000	55,000	13,000	0,110	2	NTN

Reference	d	D	B	Kg	?	Brands
7006UG/GNP42	30,000	55,000	13,000	0,110	2	NTN
7006CVUJ74	30,000	55,000	13,000	0,120	2	SNR
7006HVUJ74	30,000	55,000	13,000	0,120	2	SNR
ML7006CVUJ74S	30,000	55,000	13,000	0,124	2	SNR
ML7006HVUJ74S	30,000	55,000	13,000	0,124	2	SNR
MLE7006CVUJ74S	30,000	55,000	13,000	0,125	2	SNR
MLE7006HVUJ74S	30,000	55,000	13,000	0,122	2	SNR
7006CVDUJ74	30,000	55,000	26,000	0,246	2	SNR
7006HVDUJ74	30,000	55,000	26,000	0,245	2	SNR
ML7006CVDUJ74S	30,000	55,000	26,000	0,242	2	SNR
ML7006HVDUJ74S	30,000	55,000	26,000	0,240	2	SNR
MLE7006CVDUJ74S	30,000	55,000	26,000	0,252	2	SNR
MLE7006HVDUJ74S	30,000	55,000	26,000	0,240	2	SNR
2LA-HSE007ADG/GNP42	35,000	62,000	14,000	0,157	2	NTN
2LA-HSE007CG/GNP42	35,000	62,000	14,000	0,157	2	NTN
5S-2LA-HSE007ADG/GNP42	35,000	62,000	14,000	0,150	2	NTN
5S-2LA-HSE007CG/GNP42	35,000	62,000	14,000	0,150	2	NTN
5S-7007ADLLBG/GNP42	35,000	62,000	14,000	0,140	2	NTN
5S-7007CDLLBG/GNP42	35,000	62,000	14,000	0,140	2	NTN
5S-7007UADG/GNP42	35,000	62,000	14,000	0,140	2	NTN
5S-7007UCG/GNP42	35,000	62,000	14,000	0,140	2	NTN
7007ADLLBG/GNP42	35,000	62,000	14,000	0,150	2	NTN
7007CDLLBG/GNP42	35,000	62,000	14,000	0,150	2	NTN
7007CGD2/GNP4	35,000	62,000	14,000	0,150	2	NTN
7007UADG/GNP42	35,000	62,000	14,000	0,150	2	NTN
7007UCG/GNP4	35,000	62,000	14,000	0,150	2	NTN
7007UCG/GNP42	35,000	62,000	14,000	0,150	2	NTN
7007UCGD2/GLP4	35,000	62,000	14,000	0,150	2	NTN
7007UCGD2/GNP4	35,000	62,000	14,000	0,150	2	NTN
7007UG/GMP4/15KQTQ	35,000	62,000	14,000	0,150	2	NTN
7007UG/GMP42	35,000	62,000	14,000	0,150	2	NTN
7007UG/GNP4	35,000	62,000	14,000	0,150	2	NTN
7007CVUJ74	35,000	62,000	14,000	0,162	2	SNR
7007HVUJ74	35,000	62,000	14,000	0,158	2	SNR
ML7007CVUJ74S	35,000	62,000	14,000	0,160	2	SNR
ML7007HVUJ74S	35,000	62,000	14,000	0,160	2	SNR
MLE7007CVUJ74S	35,000	62,000	14,000	0,166	2	SNR
MLE7007HVUJ74S	35,000	62,000	14,000	0,170	2	SNR
7007CVDUJ74	35,000	62,000	28,000	0,315	2	SNR
7007HVDUJ74	35,000	62,000	28,000	0,298	2	SNR
ML7007CVDUJ74S	35,000	62,000	28,000	0,316	2	SNR
ML7007HVDUJ74S	35,000	62,000	28,000	0,318	2	SNR
MLE7007CVDUJ74S	35,000	62,000	28,000	0,326	2	SNR
MLE7007HVDUJ74S	35,000	62,000	28,000	0,318	2	SNR
2LA-HSE008ADG/GNP42	40,000	68,000	15,000	0,204	2	NTN
2LA-HSE008CG/GNP42	40,000	68,000	15,000	0,204	2	NTN
5S-2LA-HSE008ADG/GNP42	40,000	68,000	15,000	0,190	2	NTN
5S-2LA-HSE008CG/GNP42	40,000	68,000	15,000	0,190	2	NTN
5S-7008ADLLBG/GNP42	40,000	68,000	15,000	0,170	2	NTN
5S-7008CDLLBG/GNP42	40,000	68,000	15,000	0,170	2	NTN
5S-7008UADG/GNP42	40,000	68,000	15,000	0,170	2	NTN

Reference	d	D	B	Kg	?	Brands
5S-7008UCG/GNP42	40,000	68,000	15,000	0,170	2	NTN
5S-HSB008AG/G4P42	40,000	68,000	15,000	0,190	2	NTN
7008ADLLBG/GNP42	40,000	68,000	15,000	0,190	2	NTN
7008CDLLBG/GNP42	40,000	68,000	15,000	0,190	2	NTN
7008UADG/GNP42	40,000	68,000	15,000	0,190	2	NTN
7008UCG/GMP4/15KQTQ	40,000	68,000	15,000	0,190	2	NTN
7008UCG/GNP4	40,000	68,000	15,000	0,190	2	NTN
7008UCG/GNP42	40,000	68,000	15,000	0,190	2	NTN
7008UCGD2/GLP4	40,000	68,000	15,000	0,190	2	NTN
7008UG/GMP4	40,000	68,000	15,000	0,190	2	NTN
7008UG/GMP4/15KQTQ	40,000	68,000	15,000	0,190	2	NTN
7008CVUJ74	40,000	68,000	15,000	0,202	2	SNR
7008HVUJ74	40,000	68,000	15,000	0,210	2	SNR
ML7008CVUJ74S	40,000	68,000	15,000	0,198	2	SNR
ML7008HVUJ74S	40,000	68,000	15,000	0,198	2	SNR
MLE7008CVUJ74S	40,000	68,000	15,000	0,210	2	SNR
MLE7008HVUJ74S	40,000	68,000	15,000	0,206	2	SNR
7008CDB/GLP4	40,000	68,000	30,000	0,380	2	NTN
7008UCDB/GHP4	40,000	68,000	30,000	0,380	2	NTN
7008UCDB/GLP4	40,000	68,000	30,000	0,380	2	NTN
7008UCDB/GMP4	40,000	68,000	30,000	0,380	2	NTN
7008UCDB/GNP5	40,000	68,000	30,000	0,380	2	NTN
7008UDB/GMP5	40,000	68,000	30,000	0,380	2	NTN
7008UDB/GNP5	40,000	68,000	30,000	0,380	2	NTN
7008CVDUJ74	40,000	68,000	30,000	0,444	2	SNR
7008HVDUJ74	40,000	68,000	30,000	0,393	2	SNR
ML7008CVDUJ74S	40,000	68,000	30,000	0,387	2	SNR
ML7008HVDUJ74S	40,000	68,000	30,000	0,398	2	SNR
MLE7008CVDUJ74S	40,000	68,000	30,000	0,404	2	SNR
MLE7008HVDUJ74S	40,000	68,000	30,000	0,398	2	SNR
2LA-BNS009ADLLBG/GNP42	45,000	75,000	16,000	0,260	2	NTN
2LA-BNS009CLLLBG/GNP42	45,000	75,000	16,000	0,260	2	NTN
2LA-BNS009LLBG/GNP42	45,000	75,000	16,000	0,260	2	NTN
2LA-HSE009ADG/GNP42	45,000	75,000	16,000	0,232	2	NTN
2LA-HSE009CG/GNP42	45,000	75,000	16,000	0,232	2	NTN
5S-2LA-BNS009ADLLBG/GNP42	45,000	75,000	16,000	0,260	2	NTN
5S-2LA-BNS009CLLLBG/GNP42	45,000	75,000	16,000	0,260	2	NTN
5S-2LA-BNS009LLBG/GNP42	45,000	75,000	16,000	0,260	2	NTN
5S-2LA-HSE009ADG/GNP42	45,000	75,000	16,000	0,240	2	NTN
5S-2LA-HSE009CG/GNP42	45,000	75,000	16,000	0,240	2	NTN
5S-7009ADLLBG/GNP42	45,000	75,000	16,000	0,210	2	NTN
5S-7009CDLLBG/GNP42	45,000	75,000	16,000	0,210	2	NTN
5S-7009UADG/GNP42	45,000	75,000	16,000	0,210	2	NTN
5S-7009UCG/GNP42	45,000	75,000	16,000	0,210	2	NTN
7009ADLLBG/GNP42	45,000	75,000	16,000	0,240	2	NTN
7009CDLLBG/GNP42	45,000	75,000	16,000	0,240	2	NTN
7009CG/GNP4	45,000	75,000	16,000	0,240	2	NTN
7009CG/GNP4-14	45,000	75,000	16,000	0,240	2	NTN
7009G/GNP4	45,000	75,000	16,000	0,240	2	NTN
7009UADG/GNP42	45,000	75,000	16,000	0,240	2	NTN
7009UCG/GNP4	45,000	75,000	16,000	0,240	2	NTN
7009UCG/GNP42	45,000	75,000	16,000	0,240	2	NTN
7009UCGD2/GLP4	45,000	75,000	16,000	0,240	2	NTN
7009UG/GNP4	45,000	75,000	16,000	0,240	2	NTN
7009CVUJ74	45,000	75,000	16,000	0,250	2	SNR

Reference	d	D	B	Kg	?	Brands
7009HVUJ74	45,000	75,000	16,000	0,260	2	SNR
ML7009CVUJ74S	45,000	75,000	16,000	0,256	2	SNR
ML7009HVUJ74S	45,000	75,000	16,000	0,256	2	SNR
MLE7009CVUJ74S	45,000	75,000	16,000	0,266	2	SNR
MLE7009HVUJ74S	45,000	75,000	16,000	0,260	2	SNR
7009CDF/GLP4	45,000	75,000	32,000	0,480	2	NTN
7009UCDB/GLP4	45,000	75,000	32,000	0,480	2	NTN
7009CVDUJ74	45,000	75,000	32,000	0,495	2	SNR
7009HVDUJ74	45,000	75,000	32,000	0,497	2	SNR
ML7009CVDUJ74S	45,000	75,000	32,000	0,502	2	SNR
ML7009HVDUJ74S	45,000	75,000	32,000	0,500	2	SNR
MLE7009CVDUJ74S	45,000	75,000	32,000	0,522	2	SNR
MLE7009HVDUJ74S	45,000	75,000	32,000	0,500	2	SNR
2LA-BNS010ADLLBG/GNP42	50,000	80,000	16,000	0,280	2	NTN
2LA-BNS010CLLLBG/GNP42	50,000	80,000	16,000	0,280	2	NTN
2LA-BNS010LLBG/GNP42	50,000	80,000	16,000	0,280	2	NTN
2LA-HSE010ADG/GNP42	50,000	80,000	16,000	0,260	2	NTN
2LA-HSE010CG/GNP42	50,000	80,000	16,000	0,260	2	NTN
2LA-HSE010G/GNP42	50,000	80,000	16,000	0,260	2	NTN
5S-2LA-BNS010ADLLBG/GNP42	50,000	80,000	16,000	0,280	2	NTN
5S-2LA-BNS010CLLLBG/GNP42	50,000	80,000	16,000	0,280	2	NTN
5S-2LA-BNS010LLBG/GNP42	50,000	80,000	16,000	0,280	2	NTN
5S-2LA-HSE010ADG/GNP42	50,000	80,000	16,000	0,230	2	NTN
5S-2LA-HSE010CG/GNP42	50,000	80,000	16,000	0,230	2	NTN
5S-2LA-HSE010G/GNP42	50,000	80,000	16,000	0,230	2	NTN
5S-7010ADLLBG/GNP42	50,000	80,000	16,000	0,230	2	NTN
5S-7010CDLLBG/GNP42	50,000	80,000	16,000	0,230	2	NTN
5S-7010UADG/GNP42	50,000	80,000	16,000	0,230	2	NTN
5S-7010UCG/GNP42	50,000	80,000	16,000	0,230	2	NTN
7010ADLLBG/GNP42	50,000	80,000	16,000	0,260	2	NTN
7010CDLLBG/GNP42	50,000	80,000	16,000	0,260	2	NTN
7010CG/GNP4	50,000	80,000	16,000	0,260	2	NTN
7010UADG/GNP42	50,000	80,000	16,000	0,260	2	NTN
7010UCG/GMP4/15KQ3	50,000	80,000	16,000	0,260	2	NTN
7010UCG/GNP4	50,000	80,000	16,000	0,260	2	NTN
7010UCG/GNP42	50,000	80,000	16,000	0,260	2	NTN
7010UCGD2/GLP4	50,000	80,000	16,000	0,260	2	NTN
7010UCGD2/GNP4	50,000	80,000	16,000	0,260	2	NTN
7010UG/GMP42	50,000	80,000	16,000	0,260	2	NTN
7010UG/GMP42/15KQTQ	50,000	80,000	16,000	0,260	2	NTN
7010UG/GNP4	50,000	80,000	16,000	0,260	2	NTN
7010CVUJ74	50,000	80,000	16,000	0,271	2	SNR
7010HVUJ74	50,000	80,000	16,000	0,270	2	SNR
ML7010CVUJ74S	50,000	80,000	16,000	0,276	2	SNR
ML7010HVUJ74S	50,000	80,000	16,000	0,276	2	SNR
MLE7010CVUJ74S	50,000	80,000	16,000	0,288	2	SNR
MLE7010HVUJ74S	50,000	80,000	16,000	0,286	2	SNR
7010CDB/GNP5	50,000	80,000	32,000	0,520	2	NTN
7010CDFC2P5	50,000	80,000	32,000	0,520	2	NTN
7010UCDB/GLP5	50,000	80,000	32,000	0,520	2	NTN
7010UCDB/GNP4	50,000	80,000	32,000	0,520	2	NTN
7010UCDB/GNP5	50,000	80,000	32,000	0,520	2	NTN
7010CVDUJ74	50,000	80,000	32,000	0,534	2	SNR

Reference	d	D	B	Kg	?	Brands
7010HVDUJ74	50,000	80,000	32,000	0,537	2	SNR
ML7010CVDUJ74S	50,000	80,000	32,000	0,542	2	SNR
ML7010HVDUJ74S	50,000	80,000	32,000	0,550	2	SNR
MLE7010CVDUJ74S	50,000	80,000	32,000	0,564	2	SNR
MLE7010HVDUJ74S	50,000	80,000	32,000	0,564	2	SNR
HSB010CDB+8/GLP4	50,000	80,000	40,000	0,587	2	NTN
2LA-BNS011ADLLBG/GNP42	55,000	90,000	18,000	0,410	2	NTN
2LA-BNS011CLLLBG/GNP42	55,000	90,000	18,000	0,410	2	NTN
2LA-BNS011LLBG/GNP42	55,000	90,000	18,000	0,410	2	NTN
2LA-HSE011ADG/GNP42	55,000	90,000	18,000	0,400	2	NTN
2LA-HSE011CG/GNP42	55,000	90,000	18,000	0,400	2	NTN
2LA-HSE011G/GNP42	55,000	90,000	18,000	0,400	2	NTN
5S-2LA-BNS011ADLLBG/GNP42	55,000	90,000	18,000	0,410	2	NTN
5S-2LA-BNS011CLLLBG/GNP42	55,000	90,000	18,000	0,410	2	NTN
5S-2LA-BNS011LLBG/GNP42	55,000	90,000	18,000	0,410	2	NTN
5S-2LA-HSE011ADG/GNP42	55,000	90,000	18,000	0,370	2	NTN
5S-2LA-HSE011CG/GNP42	55,000	90,000	18,000	0,370	2	NTN
5S-2LA-HSE011G/GNP42	55,000	90,000	18,000	0,370	2	NTN
5S-7011UADG/GNP42	55,000	90,000	18,000	0,330	2	NTN
5S-7011UCG/GNP42	55,000	90,000	18,000	0,330	2	NTN
7011CG/GNP42/6KQTM	55,000	90,000	18,000	0,380	2	NTN
7011CP4	55,000	90,000	18,000	0,380	2	NTN
7011G/GMUP-14/6KQTM	55,000	90,000	18,000	0,380	2	NTN
7011UADG/GNP4	55,000	90,000	18,000	0,380	2	NTN
7011UADG/GNP42	55,000	90,000	18,000	0,380	2	NTN
7011UCG/GNP4	55,000	90,000	18,000	0,380	2	NTN
7011UCG/GNP42	55,000	90,000	18,000	0,380	2	NTN
7011UCG/GNP42/6KQTM	55,000	90,000	18,000	0,380	2	NTN
7011UCP4	55,000	90,000	18,000	0,380	2	NTN
7011CVUJ74	55,000	90,000	18,000	0,400	2	SNR
7011HVUJ74	55,000	90,000	18,000	0,430	2	SNR
ML7011CVUJ74S	55,000	90,000	18,000	0,408	2	SNR
ML7011HVUJ74S	55,000	90,000	18,000	0,395	2	SNR
7011CDB/GNP5	55,000	90,000	36,000	0,760	2	NTN
7011UCDB/GMP4	55,000	90,000	36,000	0,760	2	NTN
7011UCDB/GNP5	55,000	90,000	36,000	0,760	2	NTN
7011UDB/GMP5	55,000	90,000	36,000	0,760	2	NTN
HSB011CT1DB/GLUP-2	55,000	90,000	36,000	0,808	2	NTN
7011CVDUJ74	55,000	90,000	36,000	0,806	2	SNR
7011HVDUJ74	55,000	90,000	36,000	0,805	2	SNR
ML7011CVDUJ74S	55,000	90,000	36,000	0,828	2	SNR
ML7011HVDUJ74S	55,000	90,000	36,000	0,790	2	SNR
MLE7011CVUJ74S	55,000	90,000	36,000	0,420	2	SNR
MLE7011HVUJ74S	55,000	90,000	36,000	0,418	2	SNR
2LA-BNS012ADLLBG/GNP42	60,000	95,000	18,000	0,440	2	NTN
2LA-BNS012CLLLBG/GNP42	60,000	95,000	18,000	0,440	2	NTN
2LA-BNS012LLBG/GNP42	60,000	95,000	18,000	0,440	2	NTN
2LA-HSE012ADG/GNP42	60,000	95,000	18,000	0,420	2	NTN
2LA-HSE012CG/GNP42	60,000	95,000	18,000	0,420	2	NTN
2LA-HSE012G/GNP42	60,000	95,000	18,000	0,420	2	NTN

Reference	d	D	B	Kg		Brands
5S-2LA-BNS012ADLLBG/GNP42	60,000	95,000	18,000	0,440	2	NTN
5S-2LA-BNS012CLLLBG/GNP42	60,000	95,000	18,000	0,440	2	NTN
5S-2LA-BNS012LLBG/GNP42	60,000	95,000	18,000	0,440	2	NTN
5S-2LA-HSE012ADG/GNP42	60,000	95,000	18,000	0,400	2	NTN
5S-2LA-HSE012CG/GNP42	60,000	95,000	18,000	0,400	2	NTN
5S-2LA-HSE012G/GNP42	60,000	95,000	18,000	0,400	2	NTN
5S-7012UADG/GNP42	60,000	95,000	18,000	0,360	2	NTN
5S-7012UCG/GNP42	60,000	95,000	18,000	0,360	2	NTN
7012G/GNUP-13	60,000	95,000	18,000	0,410	2	NTN
7012UADG/GNP42	60,000	95,000	18,000	0,410	2	NTN
7012UCG/GLP4	60,000	95,000	18,000	0,410	2	NTN
7012UCG/GNP4	60,000	95,000	18,000	0,410	2	NTN
7012UCG/GNP42	60,000	95,000	18,000	0,410	2	NTN
7012UCGD2/GNP4	60,000	95,000	18,000	0,410	2	NTN
7012UG/GNP4	60,000	95,000	18,000	0,410	2	NTN
7012CVUJ74	60,000	95,000	18,000	0,434	2	SNR
7012HVUJ74	60,000	95,000	18,000	0,430	2	SNR
ML7012CVDUJ74S	60,000	95,000	18,000	0,894	2	SNR
ML7012CVUJ74S	60,000	95,000	18,000	0,450	2	SNR
ML7012HVDUJ74S	60,000	95,000	18,000	0,850	2	SNR
ML7012HVUJ74S	60,000	95,000	18,000	0,450	2	SNR
MLE7012CVUJ74S	60,000	95,000	18,000	0,452	2	SNR
MLE7012HVUJ74S	60,000	95,000	18,000	0,446	2	SNR
7012CDB/GNP4	60,000	95,000	36,000	0,820	2	NTN
7012CDB/GNP5	60,000	95,000	36,000	0,820	2	NTN
7012UCDB/GNP4	60,000	95,000	36,000	0,820	2	NTN
7012UCDB/GNP5	60,000	95,000	36,000	0,820	2	NTN
7012CVDUJ74	60,000	95,000	36,000	0,890	2	SNR
7012HVDUJ74	60,000	95,000	36,000	0,874	2	SNR
2LA-BNS013ADLLBG/GNP42	65,000	100,000	18,000	0,470	2	NTN
2LA-BNS013CLLLBG/GNP42	65,000	100,000	18,000	0,470	2	NTN
2LA-BNS013LLBG/GNP42	65,000	100,000	18,000	0,470	2	NTN
2LA-HSE013ADG/GNP42	65,000	100,000	18,000	0,450	2	NTN
2LA-HSE013CG/GNP42	65,000	100,000	18,000	0,450	2	NTN
2LA-HSE013G/GNP42	65,000	100,000	18,000	0,450	2	NTN
5S-2LA-BNS013ADLLBG/GNP42	65,000	100,000	18,000	0,470	2	NTN
5S-2LA-BNS013CLLLBG/GNP42	65,000	100,000	18,000	0,470	2	NTN
5S-2LA-BNS013LLBG/GNP42	65,000	100,000	18,000	0,470	2	NTN
5S-2LA-HSE013ADG/GNP42	65,000	100,000	18,000	0,420	2	NTN
5S-2LA-HSE013CG/GNP42	65,000	100,000	18,000	0,420	2	NTN
5S-2LA-HSE013G/GNP42	65,000	100,000	18,000	0,420	2	NTN
5S-7013UADG/GNP42	65,000	100,000	18,000	0,380	2	NTN
5S-7013UCG/GNP42	65,000	100,000	18,000	0,380	2	NTN
7013CG/GNP4	65,000	100,000	18,000	0,440	2	NTN
7013G/GNUP-16	65,000	100,000	18,000	0,440	2	NTN
7013G/GNUP-17	65,000	100,000	18,000	0,440	2	NTN
7013GD2/GNP4	65,000	100,000	18,000	0,440	2	NTN
7013UADG/GNP42	65,000	100,000	18,000	0,440	2	NTN
7013UCG/GNP4	65,000	100,000	18,000	0,440	2	NTN
7013UCG/GNP42	65,000	100,000	18,000	0,440	2	NTN
7013UCGD2/GLP4	65,000	100,000	18,000	0,440	2	NTN
7013UGD2/GNP4	65,000	100,000	18,000	0,440	2	NTN
7013CVUJ74	65,000	100,000	18,000	0,470	2	SNR
7013HVUJ74	65,000	100,000	18,000	0,456	2	SNR

Reference	d	D	B	Kg		Brands
ML7013CVDUJ74S	65,000	100,000	18,000	0,938	2	SNR
ML7013CVUJ74S	65,000	100,000	18,000	0,460	2	SNR
ML7013HVDUJ74S	65,000	100,000	18,000	0,884	2	SNR
ML7013HVUJ74S	65,000	100,000	18,000	0,468	2	SNR
MLE7013CVUJ74S	65,000	100,000	18,000	0,474	2	SNR
MLE7013HVUJ74S	65,000	100,000	18,000	0,476	2	SNR
HTA013DB/GNP4L	65,000	100,000	33,000	0,860	2	NTN
7013UADDB/G40P4	65,000	100,000	36,000	0,880	2	NTN
7013CVDUJ74	65,000	100,000	36,000	0,923	2	SNR
7013HVDUJ74	65,000	100,000	36,000	0,923	2	SNR
2LA-BNS014ADLLBG/GNP42	70,000	110,000	20,000	0,660	2	NTN
2LA-BNS014CLLLBG/GNP42	70,000	110,000	20,000	0,660	2	NTN
2LA-BNS014LLBG/GNP42	70,000	110,000	20,000	0,660	2	NTN
2LA-HSE014ADG/GNP42	70,000	110,000	20,000	0,640	2	NTN
2LA-HSE014CG/GNP42	70,000	110,000	20,000	0,640	2	NTN
2LA-HSE014G/GNP42	70,000	110,000	20,000	0,640	2	NTN
5S-2LA-BNS014ADLLBG/GNP42	70,000	110,000	20,000	0,660	2	NTN
5S-2LA-BNS014CLLLBG/GNP42	70,000	110,000	20,000	0,660	2	NTN
5S-2LA-BNS014LLBG/GNP42	70,000	110,000	20,000	0,660	2	NTN
5S-2LA-HSE014ADG/GNP42	70,000	110,000	20,000	0,600	2	NTN
5S-2LA-HSE014CG/GNP42	70,000	110,000	20,000	0,600	2	NTN
5S-2LA-HSE014G/GNP42	70,000	110,000	20,000	0,600	2	NTN
5S-7014UADG/GNP42	70,000	110,000	20,000	0,530	2	NTN
5S-7014UCG/GNP42	70,000	110,000	20,000	0,530	2	NTN
7014CG/GLP4	70,000	110,000	20,000	0,610	2	NTN
7014CGD2/GNP4	70,000	110,000	20,000	0,610	2	NTN
7014UADG/GNP42	70,000	110,000	20,000	0,610	2	NTN
7014UCG/GLP4	70,000	110,000	20,000	0,610	2	NTN
7014UCG/GNP4	70,000	110,000	20,000	0,610	2	NTN
7014UCG/GNP42	70,000	110,000	20,000	0,610	2	NTN
7014UCGD2/GNP4	70,000	110,000	20,000	0,610	2	NTN
7014UCP4	70,000	110,000	20,000	0,610	2	NTN
7014CVUJ74	70,000	110,000	20,000	0,650	2	SNR
7014HVUJ74	70,000	110,000	20,000	0,660	2	SNR
ML7014CVDUJ74S	70,000	110,000	20,000	0,666	2	SNR
ML7014CVUJ74S	70,000	110,000	20,000	0,648	2	SNR
ML7014HVDUJ74S	70,000	110,000	20,000	0,125	2	SNR
ML7014HVUJ74S	70,000	110,000	20,000	0,666	2	SNR
MLE7014CVUJ74S	70,000	110,000	20,000	0,684	2	SNR
MLE7014HVDUJ74S	70,000	110,000	20,000	1,258	2	SNR
MLE7014HVUJ74S	70,000	110,000	20,000	0,686	2	SNR
HTA014ADB/GNP4L	70,000	110,000	36,000	1,190	2	NTN
HTA014ADB/GNP4L	70,000	110,000	36,000	1,190	2	NTN
7014CDB/GNP4	70,000	110,000	40,000	1,220	2	NTN
7014CDB/GNP5	70,000	110,000	40,000	1,220	2	NTN
7014UCDB/GNP4	70,000	110,000	40,000	1,220	2	NTN
7014CVDUJ74	70,000	110,000	40,000	1,300	2	SNR
7014HVDUJ74	70,000	110,000	40,000	1,270	2	SNR
7014UCDTBT/GNP4	70,000	110,000	80,000	2,440	2	NTN
2LA-BNS015ADLLBG/GNP42	75,000	115,000	20,000	0,690	2	NTN
2LA-BNS015CLLLBG/GNP42	75,000	115,000	20,000	0,690	2	NTN

Reference	d	D	B	Kg	?	Brands
2LA-BNS015LLBG/GNP42	75,000	115,000	20,000	0,690	2	NTN
2LA-HSE015ADG/GNP42	75,000	115,000	20,000	0,680	2	NTN
2LA-HSE015CG/GNP42	75,000	115,000	20,000	0,680	2	NTN
2LA-HSE015G/GNP42	75,000	115,000	20,000	0,680	2	NTN
5S-2LA-BNS015ADLLBG/GNP42	75,000	115,000	20,000	0,690	2	NTN
5S-2LA-BNS015CLLLBG/GNP42	75,000	115,000	20,000	0,690	2	NTN
5S-2LA-BNS015LLBG/GNP42	75,000	115,000	20,000	0,690	2	NTN
5S-2LA-HSE015ADG/GNP42	75,000	115,000	20,000	0,640	2	NTN
5S-2LA-HSE015CG/GNP42	75,000	115,000	20,000	0,640	2	NTN
5S-2LA-HSE015G/GNP42	75,000	115,000	20,000	0,640	2	NTN
5S-7015UADG/GNP42	75,000	115,000	20,000	0,560	2	NTN
5S-7015UCG/GNP42	75,000	115,000	20,000	0,560	2	NTN
7015CG/GNP4	75,000	115,000	20,000	0,640	2	NTN
7015UADG/GNP42	75,000	115,000	20,000	0,640	2	NTN
7015UCG/GNP4	75,000	115,000	20,000	0,640	2	NTN
7015UCG/GNP42	75,000	115,000	20,000	0,640	2	NTN
7015UCGD2/GLP4	75,000	115,000	20,000	0,640	2	NTN
7015UCP4	75,000	115,000	20,000	0,640	2	NTN
7015UP4	75,000	115,000	20,000	0,640	2	NTN
7015CVUJ74	75,000	115,000	20,000	0,669	2	SNR
7015HVUJ74	75,000	115,000	20,000	0,672	2	SNR
ML7015CVDUJ74S	75,000	115,000	20,000	1,316	2	SNR
ML7015CVUJ74S	75,000	115,000	20,000	0,689	2	SNR
ML7015HVDUJ74S	75,000	115,000	20,000	0,131	2	SNR
ML7015HVUJ74S	75,000	115,000	20,000	0,690	2	SNR
HTA015AT1DB/GNP4L	75,000	115,000	36,000	1,260	2	NTN
7015CDB/GNP5	75,000	115,000	40,000	1,280	2	NTN
7015UADDB/GNP4	75,000	115,000	40,000	1,280	2	NTN
7015UCDB/GNP5	75,000	115,000	40,000	1,280	2	NTN
7015CVDUJ74	75,000	115,000	40,000	1,345	2	SNR
7015HVDUJ74	75,000	115,000	40,000	1,341	2	SNR
5S-7016UADG/GNP42	80,000	125,000	20,000	0,740	2	NTN
5S-7016UCG/GNP42	80,000	125,000	20,000	0,740	2	NTN
2LA-BNS016ADLLBG/GNP42	80,000	125,000	22,000	0,940	2	NTN
2LA-BNS016CLLLBG/GNP42	80,000	125,000	22,000	0,940	2	NTN
2LA-BNS016LLBG/GNP42	80,000	125,000	22,000	0,940	2	NTN
2LA-HSE016ADG/GNP42	80,000	125,000	22,000	0,910	2	NTN
2LA-HSE016CG/GNP42	80,000	125,000	22,000	0,910	2	NTN
2LA-HSE016G/GNP42	80,000	125,000	22,000	0,910	2	NTN
5S-2LA-BNS016ADLLBG/GNP42	80,000	125,000	22,000	0,940	2	NTN
5S-2LA-BNS016CLLLBG/GNP42	80,000	125,000	22,000	0,940	2	NTN
5S-2LA-BNS016LLBG/GNP42	80,000	125,000	22,000	0,940	2	NTN
5S-2LA-HSE016ADG/GNP42	80,000	125,000	22,000	0,860	2	NTN
5S-2LA-HSE016CG/GNP42	80,000	125,000	22,000	0,860	2	NTN
5S-2LA-HSE016G/GNP42	80,000	125,000	22,000	0,860	2	NTN
7016CG/GNP4	80,000	125,000	22,000	0,860	2	NTN
7016CG/GNUP-12	80,000	125,000	22,000	0,860	2	NTN
7016UADG/GNP42	80,000	125,000	22,000	0,860	2	NTN
7016UCG/GNP4	80,000	125,000	22,000	0,860	2	NTN
7016UCG/GNP42	80,000	125,000	22,000	0,860	2	NTN
7016UCGD2/GLP4	80,000	125,000	22,000	0,860	2	NTN
7016UCP4	80,000	125,000	22,000	0,860	2	NTN
7016CVUJ74	80,000	125,000	22,000	0,875	2	SNR

Reference	d	D	B	Kg	?	Brands
7016HVQUJ74	80,000	125,000	22,000	3,400	2	SNR
7016HVUJ74	80,000	125,000	22,000	0,890	2	SNR
ML7016CVDUJ74S	80,000	125,000	22,000	1,812	2	SNR
ML7016CVUJ74S	80,000	125,000	22,000	0,874	2	SNR
ML7016HVDUJ74S	80,000	125,000	22,000	0,179	2	SNR
ML7016HVUJ74S	80,000	125,000	22,000	0,908	2	SNR
HTA016ADB/GNP4L	80,000	125,000	40,500	1,730	2	NTN
HTA016ADB/GNP4L	80,000	125,000	40,500	1,730	2	NTN
7016UCDB/GMP4	80,000	125,000	44,000	1,720	2	NTN
7016UCDB/GNP5	80,000	125,000	44,000	1,720	2	NTN
7016CVDUJ74	80,000	125,000	44,000	1,749	2	SNR
7016HVDUJ74	80,000	125,000	44,000	1,750	2	SNR
7016UCDBT/GMP4	80,000	125,000	66,000	2,580	2	NTN
HSB016CDBT/GNP4	80,000	125,000	66,000	2,567	2	NTN
2LA-BNS017ADLLBG/GNP42	85,000	130,000	22,000	0,980	2	NTN
2LA-BNS017CLLLBG/GNP42	85,000	130,000	22,000	0,980	2	NTN
2LA-BNS017LLBG/GNP42	85,000	130,000	22,000	0,980	2	NTN
2LA-HSE017ADG/GNP42	85,000	130,000	22,000	0,960	2	NTN
2LA-HSE017CG/GNP42	85,000	130,000	22,000	0,960	2	NTN
2LA-HSE017G/GNP42	85,000	130,000	22,000	0,960	2	NTN
5S-2LA-BNS017ADLLBG/GNP42	85,000	130,000	22,000	0,980	2	NTN
5S-2LA-BNS017CLLLBG/GNP42	85,000	130,000	22,000	0,980	2	NTN
5S-2LA-BNS017LLBG/GNP42	85,000	130,000	22,000	0,980	2	NTN
5S-2LA-HSE017ADG/GNP42	85,000	130,000	22,000	0,900	2	NTN
5S-2LA-HSE017CG/GNP42	85,000	130,000	22,000	0,900	2	NTN
5S-2LA-HSE017G/GNP42	85,000	130,000	22,000	0,900	2	NTN
5S-7017UADG/GNP42	85,000	130,000	22,000	0,780	2	NTN
5S-7017UCG/GNP42	85,000	130,000	22,000	0,780	2	NTN
7017CG/GNUP-2	85,000	130,000	22,000	0,900	2	NTN
7017UADG/GNP42	85,000	130,000	22,000	0,900	2	NTN
7017UCG/GNP4	85,000	130,000	22,000	0,900	2	NTN
7017UCG/GNP42	85,000	130,000	22,000	0,900	2	NTN
7017CVUJ74	85,000	130,000	22,000	0,944	2	SNR
7017HVUJ74	85,000	130,000	22,000	0,970	2	SNR
ML7017CVDUJ74S	85,000	130,000	22,000	1,884	2	SNR
ML7017CVUJ74S	85,000	130,000	22,000	0,946	2	SNR
ML7017HVDUJ74S	85,000	130,000	22,000	0,185	2	SNR
ML7017HVUJ74S	85,000	130,000	22,000	0,942	2	SNR
7017CDB/GMP5	85,000	130,000	44,000	1,800	2	NTN
7017CDB/GNP5	85,000	130,000	44,000	1,800	2	NTN
7017UCDB/GMP5	85,000	130,000	44,000	1,800	2	NTN
7017UCDB/GNP5	85,000	130,000	44,000	1,800	2	NTN
HSB017CDB/G01UP-4	85,000	130,000	44,000	1,920	2	NTN
7017CVDUJ74	85,000	130,000	44,000	1,911	2	SNR
7017HVDUJ74	85,000	130,000	44,000	1,846	2	SNR
2LA-BNS018ADLLBG/GNP42	90,000	140,000	24,000	1,290	2	NTN
2LA-BNS018CLLLBG/GNP42	90,000	140,000	24,000	1,290	2	NTN
2LA-BNS018LLBG/GNP42	90,000	140,000	24,000	1,290	2	NTN

Reference	d	D	B	Kg	?	Brands
2LA-HSE018ADG/GNP42	90,000	140,000	24,000	1,250	2	NTN
2LA-HSE018CG/GNP42	90,000	140,000	24,000	1,250	2	NTN
2LA-HSE018G/GNP42	90,000	140,000	24,000	1,250	2	NTN
5S-2LA-BNS018ADLLBG/GNP42	90,000	140,000	24,000	1,290	2	NTN
5S-2LA-BNS018CLLLBG/GNP42	90,000	140,000	24,000	1,290	2	NTN
5S-2LA-BNS018LLBG/GNP42	90,000	140,000	24,000	1,290	2	NTN
5S-2LA-HSE018ADG/GNP42	90,000	140,000	24,000	1,180	2	NTN
5S-2LA-HSE018CG/GNP42	90,000	140,000	24,000	1,180	2	NTN
5S-2LA-HSE018G/GNP42	90,000	140,000	24,000	1,180	2	NTN
5S-7018UADG/GNP42	90,000	140,000	24,000	1,000	2	NTN
5S-7018UCG/GNP42	90,000	140,000	24,000	1,000	2	NTN
7018CG/GNP4	90,000	140,000	24,000	1,170	2	NTN
7018UADG/GNP42	90,000	140,000	24,000	1,170	2	NTN
7018UCG/GLP4	90,000	140,000	24,000	1,170	2	NTN
7018UCG/GNP4	90,000	140,000	24,000	1,170	2	NTN
7018UCG/GNP42	90,000	140,000	24,000	1,170	2	NTN
7018UP5	90,000	140,000	24,000	1,170	2	NTN
7018CVUJ74	90,000	140,000	24,000	1,229	2	SNR
7018HVUJ74	90,000	140,000	24,000	1,260	2	SNR
ML7018CVDUJ74S	90,000	140,000	24,000	2,560	2	SNR
ML7018CVUJ74S	90,000	140,000	24,000	1,270	2	SNR
ML7018HVDUJ74S	90,000	140,000	24,000	2,384	2	SNR
ML7018HVUJ74S	90,000	140,000	24,000	1,270	2	SNR
HTA018ADB/GNP4L	90,000	140,000	45,000	2,400	2	NTN
HTA018UADB/GNP4L	90,000	140,000	45,000	2,400	2	NTN
7018CDB/GMP5	90,000	140,000	48,000	2,340	2	NTN
7018CDB/GNP4	90,000	140,000	48,000	2,340	2	NTN
7018UCDB/G05UP-6	90,000	140,000	48,000	2,340	2	NTN
7018UCDB/GNP4	90,000	140,000	48,000	2,340	2	NTN
7018CVDUJ74	90,000	140,000	48,000	2,459	2	SNR
7018HVDUJ74	90,000	140,000	48,000	2,437	2	SNR
7018UCDTBT/GMP4	90,000	140,000	96,000	4,680	2	NTN
2LA-BNS019ADLLBG/GNP42	95,000	145,000	24,000	1,340	2	NTN
2LA-BNS019CLLLBG/GNP42	95,000	145,000	24,000	1,340	2	NTN
2LA-BNS019LLBG/GNP42	95,000	145,000	24,000	1,340	2	NTN
2LA-HSE019ADG/GNP42	95,000	145,000	24,000	1,300	2	NTN
2LA-HSE019CG/GNP42	95,000	145,000	24,000	1,300	2	NTN
2LA-HSE019G/GNP42	95,000	145,000	24,000	1,300	2	NTN
5S-2LA-BNS019ADLLBG/GNP42	95,000	145,000	24,000	1,340	2	NTN
5S-2LA-BNS019CLLLBG/GNP42	95,000	145,000	24,000	1,340	2	NTN
5S-2LA-BNS019LLBG/GNP42	95,000	145,000	24,000	1,340	2	NTN
5S-2LA-HSE019ADG/GNP42	95,000	145,000	24,000	1,230	2	NTN
5S-2LA-HSE019CG/GNP42	95,000	145,000	24,000	1,230	2	NTN
5S-2LA-HSE019G/GNP42	95,000	145,000	24,000	1,230	2	NTN
5S-7019UADG/GNP42	95,000	145,000	24,000	1,090	2	NTN
5S-7019UCG/GNP42	95,000	145,000	24,000	1,090	2	NTN
7019P5	95,000	145,000	24,000	1,220	2	NTN
7019UADG/GNP42	95,000	145,000	24,000	1,220	2	NTN
7019UCG/GNP4	95,000	145,000	24,000	1,220	2	NTN
7019UCG/GNP42	95,000	145,000	24,000	1,220	2	NTN
7019CVUJ74	95,000	145,000	24,000	1,320	2	SNR
7019HVUJ74	95,000	145,000	24,000	1,250	2	SNR

Reference	d	D	B	Kg	?	Brands
ML7019CVUJ74S	95,000	145,000	24,000	1,263	2	SNR
ML7019HVUJ74S	95,000	145,000	24,000	1,263	2	SNR
7019CVDUJ74	95,000	145,000	48,000	2,504	2	SNR
7019HVDUJ74	95,000	145,000	48,000	2,495	2	SNR
HSB019CDTBT/G5UP-1	95,000	145,000	96,000	5,200	2	NTN
2LA-BNS020ADLLBG/GNP42	100,000	150,000	24,000	1,400	2	NTN
2LA-BNS020CLLLBG/GNP42	100,000	150,000	24,000	1,400	2	NTN
2LA-BNS020LLBG/GNP42	100,000	150,000	24,000	1,400	2	NTN
2LA-HSE020ADG/GNP42	100,000	150,000	24,000	1,360	2	NTN
2LA-HSE020CG/GNP42	100,000	150,000	24,000	1,360	2	NTN
2LA-HSE020G/GNP42	100,000	150,000	24,000	1,360	2	NTN
5S-2LA-BNS020ADLLBG/GNP42	100,000	150,000	24,000	1,400	2	NTN
5S-2LA-BNS020CLLLBG/GNP42	100,000	150,000	24,000	1,400	2	NTN
5S-2LA-BNS020LLBG/GNP42	100,000	150,000	24,000	1,400	2	NTN
5S-2LA-HSE020ADG/GNP42	100,000	150,000	24,000	1,280	2	NTN
5S-2LA-HSE020CG/GNP42	100,000	150,000	24,000	1,280	2	NTN
5S-2LA-HSE020G/GNP42	100,000	150,000	24,000	1,280	2	NTN
5S-7020UADG/GNP42	100,000	150,000	24,000	1,090	2	NTN
5S-7020UCG/GNP42	100,000	150,000	24,000	1,090	2	NTN
7020CG/GLP4	100,000	150,000	24,000	1,270	2	NTN
7020UADG/GNP42	100,000	150,000	24,000	1,270	2	NTN
7020UCG/GNP4	100,000	150,000	24,000	1,270	2	NTN
7020UCG/GNP42	100,000	150,000	24,000	1,270	2	NTN
7020UCGD2/GLP4	100,000	150,000	24,000	1,270	2	NTN
7020UCGD2/GNP4	100,000	150,000	24,000	1,270	2	NTN
7020CVUJ74	100,000	150,000	24,000	1,340	2	SNR
7020HVUJ74	100,000	150,000	24,000	1,370	2	SNR
ML7020CVDUJ74S	100,000	150,000	24,000	2,722	2	SNR
ML7020CVUJ74S	100,000	150,000	24,000	1,360	2	SNR
ML7020HVDUJ74S	100,000	150,000	24,000	2,638	2	SNR
ML7020HVUJ74S	100,000	150,000	24,000	1,360	2	SNR
HTA020ADB/GNP4L	100,000	150,000	45,000	2,620	2	NTN
HTA020DB/G10UP-21	100,000	150,000	45,000	2,620	2	NTN
HTA020DB/GNP4L	100,000	150,000	45,000	2,620	2	NTN
7020CDB/GNP4	100,000	150,000	48,000	2,540	2	NTN
7020UADB/GMP4	100,000	150,000	48,000	2,540	2	NTN
7020UCDB/GNP4	100,000	150,000	48,000	2,540	2	NTN
7020UCDB/GNP5	100,000	150,000	48,000	2,540	2	NTN
HSB020DB/G05P4	100,000	150,000	48,000	2,678	2	NTN
HSB020T1DB/G01P4L	100,000	150,000	48,000	2,678	2	NTN
7020CVDUJ74	100,000	150,000	48,000	2,591	2	SNR
7020HVDUJ74	100,000	150,000	48,000	2,598	2	SNR
HSB020CDTBT/GLP4	100,000	150,000	96,000	5,362	2	NTN
2LA-HSE021ADG/GNP42	105,000	160,000	26,000	1,730	2	NTN
2LA-HSE021CG/GNP42	105,000	160,000	26,000	1,730	2	NTN
2LA-HSE021G/GNP42	105,000	160,000	26,000	1,730	2	NTN
5S-2LA-HSE021ADG/GNP42	105,000	160,000	26,000	1,630	2	NTN

Reference	d	D	B	Kg		Brands
5S-2LA-HSE021CG/GNP42	105,000	160,000	26,000	1,630	2	NTN
5S-2LA-HSE021G/GNP42	105,000	160,000	26,000	1,630	2	NTN
5S-7021UADG/GNP42	105,000	160,000	26,000	1,340	2	NTN
5S-7021UCG/GNP42	105,000	160,000	26,000	1,340	2	NTN
7021CG/GNP4	105,000	160,000	26,000	1,580	2	NTN
7021UADG/GNP42	105,000	160,000	26,000	1,580	2	NTN
7021UCG/GNP42	105,000	160,000	26,000	1,580	2	NTN
7021CVUJ74	105,000	160,000	26,000	1,632	2	SNR
7021HVUJ74	105,000	160,000	26,000	1,651	2	SNR
7021CVDUJ74	105,000	160,000	52,000	3,278	2	SNR
7021HVDUJ74	105,000	160,000	52,000	3,307	2	SNR
2LA-HSE022ADG/GNP42	110,000	170,000	28,000	2,130	2	NTN
2LA-HSE022CG/GNP42	110,000	170,000	28,000	2,130	2	NTN
2LA-HSE022G/GNP42	110,000	170,000	28,000	2,130	2	NTN
5S-2LA-HSE022ADG/GNP42	110,000	170,000	28,000	1,990	2	NTN
5S-2LA-HSE022CG/GNP42	110,000	170,000	28,000	1,990	2	NTN
5S-2LA-HSE022G/GNP42	110,000	170,000	28,000	1,990	2	NTN
5S-7022UADG/GNP42	110,000	170,000	28,000	1,690	2	NTN
5S-7022UCG/GNP42	110,000	170,000	28,000	1,690	2	NTN
7022CG/GNP4	110,000	170,000	28,000	1,980	2	NTN
7022UADG/GNP42	110,000	170,000	28,000	1,980	2	NTN
7022UCG/GNP4	110,000	170,000	28,000	1,980	2	NTN
7022UCG/GNP42	110,000	170,000	28,000	1,980	2	NTN
7022UGP4	110,000	170,000	28,000	1,980	2	NTN
7022CVUJ74	110,000	170,000	28,000	2,045	2	SNR
7022HVUJ74	110,000	170,000	28,000	2,032	2	SNR
ML7022CVUJ74S	110,000	170,000	28,000	2,019	2	SNR
ML7022HVUJ74S	110,000	170,000	28,000	2,019	2	SNR
HTA022ADB/GNP4L	110,000	170,000	54,000	4,220	2	NTN
HTA022ADBP4LV2	110,000	170,000	54,000	4,220	2	NTN
HTA022DB/GNP4L	110,000	170,000	54,000	4,220	2	NTN
HSB022T1BDB/GNP4L	110,000	170,000	56,000	4,203	2	NTN
7022CVDUJ74	110,000	170,000	56,000	4,066	2	SNR
7022HVDUJ74	110,000	170,000	56,000	4,062	2	SNR
7022UDBTP4	110,000	170,000	84,000	5,940	2	NTN
7022UCDTBTT/G095P4	110,000	170,000	140,000	9,900	2	NTN
2LA-HSE024ADG/GNP42	120,000	180,000	28,000	2,280	2	NTN
2LA-HSE024CG/GNP42	120,000	180,000	28,000	2,280	2	NTN
2LA-HSE024G/GNP42	120,000	180,000	28,000	2,280	2	NTN
5S-2LA-HSE024ADG/GNP42	120,000	180,000	28,000	2,140	2	NTN
5S-2LA-HSE024CG/GNP42	120,000	180,000	28,000	2,140	2	NTN
5S-2LA-HSE024G/GNP42	120,000	180,000	28,000	2,140	2	NTN
5S-7024UADG/GNP42	120,000	180,000	28,000	1,800	2	NTN
5S-7024UCG/GNP42	120,000	180,000	28,000	1,800	2	NTN
7024UADG/GNP42	120,000	180,000	28,000	2,110	2	NTN
7024UCG/GNP42	120,000	180,000	28,000	2,110	2	NTN
7024CVUJ74	120,000	180,000	28,000	2,240	2	SNR
7024HVUJ74	120,000	180,000	28,000	2,170	2	SNR
ML7024CVUJ74S	120,000	180,000	28,000	2,168	2	SNR

Reference	d	D	B	Kg		Brands
ML7024HVUJ74S	120,000	180,000	28,000	2,168	2	SNR
HTA024ADB/GNP4L	120,000	180,000	54,000	4,500	2	NTN
HTA024DB/G15UP-21	120,000	180,000	54,000	4,500	2	NTN
HTA024DB/GNP4L	120,000	180,000	54,000	4,500	2	NTN
7024UADDB/GMP42	120,000	180,000	56,000	4,220	2	NTN
7024UCDB/GNP5	120,000	180,000	56,000	4,220	2	NTN
7024CVDUJ74	120,000	180,000	56,000	4,341	2	SNR
7024HVDUJ74	120,000	180,000	56,000	4,476	2	SNR
2LA-BNS026ADLLBG/GLP42/L749	130,000	200,000	33,000	3,498	2	NTN
2LA-HSE026ADG/GNP42	130,000	200,000	33,000	3,400	2	NTN
2LA-HSE026CG/GNP42	130,000	200,000	33,000	3,400	2	NTN
2LA-HSE026G/GNP42	130,000	200,000	33,000	3,400	2	NTN
5S-2LA-HSE026ADG/GNP42	130,000	200,000	33,000	3,180	2	NTN
5S-2LA-HSE026CG/GNP42	130,000	200,000	33,000	3,180	2	NTN
5S-2LA-HSE026G/GNP42	130,000	200,000	33,000	3,180	2	NTN
5S-7026UADG/GNP42	130,000	200,000	33,000	2,800	2	NTN
5S-7026UCG/GNP42	130,000	200,000	33,000	2,800	2	NTN
7026UADG/GNP42	130,000	200,000	33,000	3,250	2	NTN
7026UCG/GNP4	130,000	200,000	33,000	3,250	2	NTN
7026UCG/GNP42	130,000	200,000	33,000	3,250	2	NTN
7026CVUJ74	130,000	200,000	33,000	3,206	2	SNR
7026HVUJ74	130,000	200,000	33,000	3,241	2	SNR
ML7026CVUJ74S	130,000	200,000	33,000	3,306	2	SNR
ML7026HVUJ74S	130,000	200,000	33,000	3,306	2	SNR
HTA026ADB/GNP4L	130,000	200,000	63,000	6,660	2	NTN
HTA026DB/GNP4L	130,000	200,000	63,000	6,660	2	NTN
7026CVDUJ74	130,000	200,000	66,000	6,421	2	SNR
7026HVDUJ74	130,000	200,000	66,000	6,490	2	SNR
2LA-HSE028ADG/GNP42	140,000	210,000	33,000	3,680	2	NTN
2LA-HSE028CG/GNP42	140,000	210,000	33,000	3,680	2	NTN
2LA-HSE028G/GNP42	140,000	210,000	33,000	3,680	2	NTN
5S-2LA-HSE028ADG/GNP42	140,000	210,000	33,000	3,410	2	NTN
5S-2LA-HSE028CG/GNP42	140,000	210,000	33,000	3,410	2	NTN
5S-2LA-HSE028G/GNP42	140,000	210,000	33,000	3,410	2	NTN
5S-7028CT1B/GNP42	140,000	210,000	33,000	3,789	2	NTN
7028CG/GNP4	140,000	210,000	33,000	3,789	2	NTN
7028CP4	140,000	210,000	33,000	3,789	2	NTN
7028CP5	140,000	210,000	33,000	3,789	2	NTN
7028CT1B/GNP42	140,000	210,000	33,000	3,440	2	NTN
7028DB/GHP4	140,000	210,000	33,000	7,560	2	NTN
7028CVUJ74	140,000	210,000	33,000	3,460	2	SNR
7028HVUJ74	140,000	210,000	33,000	3,440	2	SNR
HTA028UAT2DB/GNP4L	140,000	210,000	63,000	7,200	2	NTN
HTA028UDB/GNP4L	140,000	210,000	63,000	7,200	2	NTN
7028CDB/GMP4	140,000	210,000	66,000	7,578	2	NTN
7028CDB/GNP4	140,000	210,000	66,000	7,578	2	NTN
7028CDB/GNP5	140,000	210,000	66,000	7,578	2	NTN
7028T1DTP5	140,000	210,000	66,000	7,920	2	NTN

Reference	d	D	B	Kg		Brands
7028UADEX1DB/G13P4	140,000	210,000	66,000	7,920	2	NTN
7028CVDUJ74	140,000	210,000	66,000	7,045	2	SNR
7028HVDUJ74	140,000	210,000	66,000	7,640	2	SNR
2LA-HSE030ADG/GNP42	150,000	225,000	35,000	4,460	2	NTN
2LA-HSE030CG/GNP42	150,000	225,000	35,000	4,460	2	NTN
2LA-HSE030G/GNP42	150,000	225,000	35,000	4,460	2	NTN
5S-2LA-HSE030ADG/GNP42	150,000	225,000	35,000	4,170	2	NTN
5S-2LA-HSE030CG/GNP42	150,000	225,000	35,000	4,170	2	NTN
5S-2LA-HSE030G/GNP42	150,000	225,000	35,000	4,170	2	NTN
5S-7030CT1B/GNP42	150,000	225,000	35,000	4,607	2	NTN
7030CG/GNP4	150,000	225,000	35,000	4,607	2	NTN
7030CP2	150,000	225,000	35,000	4,607	2	NTN
7030CP4	150,000	225,000	35,000	4,607	2	NTN
7030CP5	150,000	225,000	35,000	4,607	2	NTN
7030CT1B/GNP42	150,000	225,000	35,000	4,190	2	NTN
7030P5	150,000	225,000	35,000	4,620	2	NTN
7030CVUJ74	150,000	225,000	35,000	4,362	2	SNR
7030HVUJ74	150,000	225,000	35,000	4,232	2	SNR
HTA030ADB/G085UP-2	150,000	225,000	67,500	8,820	2	NTN
HTA030DB/GNP4L	150,000	225,000	67,500	8,820	2	NTN
7030CDB/GMP2	150,000	225,000	70,000	9,640	2	NTN
7030CDB/GNP4	150,000	225,000	70,000	9,214	2	NTN
7030CDB/GNP5	150,000	225,000	70,000	9,214	2	NTN
7030CDTP2	150,000	225,000	70,000	9,640	2	NTN
7030CDTP4	150,000	225,000	70,000	9,640	2	NTN
7030DB/GNP4	150,000	225,000	70,000	9,640	2	NTN
7030CVDUJ74	150,000	225,000	70,000	8,576	2	SNR
7030HVDUJ74	150,000	225,000	70,000	8,800	2	SNR
7030CDBT/GMP4	150,000	225,000	105,000	13,800	2	NTN
7030CT1DBT+25/GMP4	150,000	225,000	130,000	14,042	2	NTN
7030CDBT/GNP4	150,000	225,000	140,000	13,800	2	NTN
2LA-BNS032ADLLBG/GLP42/L749	160,000	240,000	38,000	5,654	2	NTN
2LA-HSE032ADG/GNP42	160,000	240,000	38,000	5,460	2	NTN
2LA-HSE032CG/GNP42	160,000	240,000	38,000	5,460	2	NTN
2LA-HSE032G/GNP42	160,000	240,000	38,000	5,460	2	NTN
5S-2LA-HSE032ADG/GNP42	160,000	240,000	38,000	5,090	2	NTN
5S-2LA-HSE032CG/GNP42	160,000	240,000	38,000	5,090	2	NTN
5S-2LA-HSE032G/GNP42	160,000	240,000	38,000	5,090	2	NTN
5S-7032CT1B/GNP42	160,000	240,000	38,000	5,960	2	NTN
7032CG/GLP4	160,000	240,000	38,000	5,960	2	NTN
7032CP4	160,000	240,000	38,000	5,648	2	NTN
7032CP5	160,000	240,000	38,000	5,648	2	NTN
7032CT1B/GNP42	160,000	240,000	38,000	5,140	2	NTN
7032P5	160,000	240,000	38,000	5,960	2	NTN
7032CVUJ74	160,000	240,000	38,000	5,222	2	SNR
7032HVUJ74	160,000	240,000	38,000	5,206	2	SNR
HTA032ADB/GNP4L	160,000	240,000	72,000	10,500	2	NTN
HTA032DB/G25P4L	160,000	240,000	72,000	10,472	2	NTN
HTA032DB/G60P4L	160,000	240,000	72,000	10,472	2	NTN
HTA032DB/GNP4L	160,000	240,000	72,000	10,472	2	NTN
HTA032UAT2DB/GNP4L	160,000	240,000	72,000	10,800	2	NTN
HTA032UT2DB/GNP4L	160,000	240,000	72,000	10,800	2	NTN

Reference	d	D	B	Kg		Brands
7032CDB/GNP4	160,000	240,000	76,000	11,296	2	NTN
7032CDB/GMP5	160,000	240,000	76,000	11,296	2	NTN
7032CDB/GNP5	160,000	240,000	76,000	11,296	2	NTN
7032CDF/GNP5	160,000	240,000	76,000	11,296	2	NTN
7032DB/GLP5	160,000	240,000	76,000	10,146	2	NTN
7032DFCS54P4	160,000	240,000	76,000	11,920	2	NTN
7032CVDUJ74	160,000	240,000	76,000	10,390	2	SNR
7032HVDUJ74	160,000	240,000	76,000	10,470	2	SNR
7032CDBT/GMP4	160,000	240,000	152,000	23,840	2	NTN
7032DTBT/GNP4	160,000	240,000	152,000	23,840	2	NTN
7032DTBT/GMP5	160,000	240,000	152,000	23,840	2	NTN
2LA-HSE034ADG/GNP42	170,000	260,000	42,000	7,370	2	NTN
2LA-HSE034CG/GNP42	170,000	260,000	42,000	7,370	2	NTN
2LA-HSE034G/GNP42	170,000	260,000	42,000	7,370	2	NTN
5S-2LA-HSE034ADG/GNP42	170,000	260,000	42,000	6,900	2	NTN
5S-2LA-HSE034CG/GNP42	170,000	260,000	42,000	6,900	2	NTN
5S-2LA-HSE034G/GNP42	170,000	260,000	42,000	6,900	2	NTN
5S-7034CT1B/GNP42	170,000	260,000	42,000	7,619	2	NTN
7034CP5	170,000	260,000	42,000	7,619	2	NTN
7034CT1B/GNP42	170,000	260,000	42,000	6,940	2	NTN
7034CVUJ74	170,000	260,000	42,000	7,088	2	SNR
7034HVUJ74	170,000	260,000	42,000	7,179	2	SNR
HTA034ADB/GNP4L	170,000	260,000	81,000	14,348	2	NTN
HTA034UDB/GMP4L	170,000	260,000	81,000	7,200	2	NTN
7034CDB/GLP5	170,000	260,000	84,000	15,238	2	NTN
7034CDB/GNP5	170,000	260,000	84,000	15,238	2	NTN
7034T1ADB/GMP42	170,000	260,000	84,000	15,238	2	NTN
7034CVDUJ74	170,000	260,000	84,000	14,365	2	SNR
7034HVDUJ74	170,000	260,000	84,000	14,400	2	SNR
7034CDBT/GMP5	170,000	260,000	126,000	23,880	2	NTN
5S-7036CT1B/GNP42	180,000	280,000	46,000	9,120	2	NTN
7036CT1B/GNP42	180,000	280,000	46,000	9,120	2	NTN
7036P5	180,000	280,000	46,000	9,120	2	NTN
7036CVUJ74	180,000	280,000	46,000	9,020	2	SNR
7036HVUJ74	180,000	280,000	46,000	9,024	2	SNR
HTA036ADB/GNP4L	180,000	280,000	90,000	20,600	2	NTN
HTA036UAL1BDB/GNP4L	180,000	280,000	90,000	21,200	2	NTN
7036DBP5	180,000	280,000	92,000	20,000	2	NTN
7036CVDUJ74	180,000	280,000	92,000	18,000	2	SNR
7036HVDUJ74	180,000	280,000	92,000	18,031	2	SNR
HTA938UAT1BDBCS05P5L	190,000	260,000	63,000	10,000	2	NTN
5S-7038CT1B/GNP42	190,000	290,000	46,000	10,400	2	NTN
7038CP5	190,000	290,000	46,000	10,400	2	NTN
7038CT1B/GNP42	190,000	290,000	46,000	9,530	2	NTN
5S-7040CT1B/GNP42	200,000	310,000	51,000	12,300	2	NTN
7040CT1B/GNP42	200,000	310,000	51,000	12,300	2	NTN
7040CVUJ74	200,000	310,000	51,000	12,232	2	SNR
7040HVUJ74	200,000	310,000	51,000	12,182	2	SNR

Reference	d	D	B	Kg		Brands
HTB040DB/GNP4L	200,000	310,000	87,500	24,500	2	NTN
HTA040DB/G75P4L	200,000	310,000	99,000	27,400	2	NTN
HTA040L1BDB/GNP4L	200,000	310,000	99,000	13,346	2	NTN
7040DB/GNP5	200,000	310,000	102,000	28,000	2	NTN
7040CVDUJ74	200,000	310,000	102,000	26,000	2	SNR
7040HVDUJ74	200,000	310,000	102,000	24,428	2	SNR
7040DB+16D/GNP4	200,000	310,000	118,000	27,600	2	NTN
7040DB+43D2CS54P5	200,000	310,000	145,000	1,111	2	NTN
HTA044UAL1BDB/GMP4L	220,000	340,000	108,000	36,200	2	NTN
HTA044UAL1BDB/GNP4L	220,000	340,000	108,000	36,200	2	NTN
7044DBT/GMP5	220,000	340,000	168,000	54,600	2	NTN
7848DB/GNP5	240,000	300,000	56,000	8,560	2	NTN
HTA048UAL1BDB/GMP4L	240,000	360,000	108,000	38,443	2	NTN
7056CDB/GLP5	280,000	420,000	130,000	61,400	2	NTN
7060CDB/GLP5	300,000	460,000	148,000	73,500	2	NTN
7060CDB+26D2/GNP5	300,000	460,000	174,000	86,180	2	NTN
5S-7200UCG/GNP42	10,000	30,000	9,000	0,029	2	NTN
7200CG/GNP4	10,000	30,000	9,000	0,029	2	NTN
7200T2G/GMP42	10,000	30,000	9,000	0,029	2	NTN
7200UCG/GNP42	10,000	30,000	9,000	0,029	2	NTN
7200CG1UJ74	10,000	30,000	9,000	0,037	2	SNR
7200HG1UJ74	10,000	30,000	9,000	0,034	2	SNR
7200CDB/GNP5	10,000	30,000	18,000	0,058	2	NTN
7200CG1DUJ74	10,000	30,000	18,000	0,066	2	SNR
7200HG1DUJ74	10,000	30,000	18,000	0,066	2	SNR
5S-7201UCG/GNP42	12,000	32,000	10,000	0,036	2	NTN
7201CG/GNP4	12,000	32,000	10,000	0,036	2	NTN
7201CGD2/GLP4	12,000	32,000	10,000	0,036	2	NTN
7201UCG/GNP42	12,000	32,000	10,000	0,036	2	NTN
7201CG1UJ74	12,000	32,000	10,000	0,041	2	SNR
7201HG1UJ74	12,000	32,000	10,000	0,041	2	SNR
7201T2DB/GNP5	12,000	32,000	20,000	0,072	2	NTN
7201CG1DUJ74	12,000	32,000	20,000	0,080	2	SNR
7201HG1DUJ74	12,000	32,000	20,000	0,079	2	SNR
5S-7202UCG/GNP42	15,000	35,000	11,000	0,045	2	NTN
7202CG/GNP4	15,000	35,000	11,000	0,045	2	NTN
7202CGD2/GLP4	15,000	35,000	11,000	0,045	2	NTN
7202CGD2/GNP4	15,000	35,000	11,000	0,045	2	NTN
7202UCG/GNP42	15,000	35,000	11,000	0,045	2	NTN
7202CG1UJ74	15,000	35,000	11,000	0,048	2	SNR
7202HG1UJ74	15,000	35,000	11,000	0,051	2	SNR
7202CG1DUJ74	15,000	35,000	22,000	0,096	2	SNR
7202HG1DUJ74	15,000	35,000	22,000	0,095	2	SNR
5S-7203UCG/GNP42	17,000	40,000	12,000	0,062	2	NTN
7203 CG/GN P4	17,000	40,000	12,000	0,062	2	NTN
7203CG/GLP4	17,000	40,000	12,000	0,062	2	NTN
7203CG/GNP4	17,000	40,000	12,000	0,062	2	NTN
7203CGD2/GLP4	17,000	40,000	12,000	0,062	2	NTN
7203CGNP4	17,000	40,000	12,000	0,062	2	NTN

Reference	d	D	B	Kg		Brands
7203CP5	17,000	40,000	12,000	0,062	2	NTN
7203T2G/GMP42	17,000	40,000	12,000	0,062	2	NTN
7203T2G/GNP4	17,000	40,000	12,000	0,062	2	NTN
7203UCG/GNP42	17,000	40,000	12,000	0,062	2	NTN
7203CG1UJ74	17,000	40,000	12,000	0,069	2	SNR
7203HG1UJ74	17,000	40,000	12,000	0,068	2	SNR
7203CG1DUJ74	17,000	40,000	24,000	0,136	2	SNR
7203HG1DUJ74	17,000	40,000	24,000	0,135	2	SNR
5S-7204UCG/GNP42	20,000	47,000	14,000	0,100	2	NTN
7204CG/GNP4	20,000	47,000	14,000	0,100	2	NTN
7204CGD2/GLP4	20,000	47,000	14,000	0,100	2	NTN
7204T2G/GNP4	20,000	47,000	14,000	0,100	2	NTN
7204UCG/GNP42	20,000	47,000	14,000	0,100	2	NTN
7204CG1UJ74	20,000	47,000	14,000	0,108	2	SNR
7204HG1UJ74	20,000	47,000	14,000	0,110	2	SNR
7204CDB/GNP5	20,000	47,000	28,000	0,200	2	NTN
7204CG1DUJ74	20,000	47,000	28,000	0,218	2	SNR
7204HG1DUJ74	20,000	47,000	28,000	0,220	2	SNR
5S-7205UCG/GNP42	25,000	52,000	15,000	0,120	2	NTN
7205CG/GLP4	25,000	52,000	15,000	0,120	2	NTN
7205CG/GNP4	25,000	52,000	15,000	0,120	2	NTN
7205CGD2/GLP4	25,000	52,000	15,000	0,120	2	NTN
7205T1G/GNP4	25,000	52,000	15,000	0,120	2	NTN
7205UCG/GNP42	25,000	52,000	15,000	0,120	2	NTN
7205CG1UJ74	25,000	52,000	15,000	0,131	2	SNR
7205HG1UJ74	25,000	52,000	15,000	0,132	2	SNR
7205CDB/GLP4	25,000	52,000	30,000	0,240	2	NTN
7205CDTP5	25,000	52,000	30,000	0,240	2	NTN
7205HTDF/GMP5	25,000	52,000	30,000	0,240	2	NTN
7205CG1DUJ74	25,000	52,000	30,000	0,265	2	SNR
7205HG1DUJ74	25,000	52,000	30,000	0,265	2	SNR
5S-7206UCG/GNP42	30,000	62,000	16,000	0,190	2	NTN
7206CG/GLP4	30,000	62,000	16,000	0,190	2	NTN
7206CG/GNP4	30,000	62,000	16,000	0,190	2	NTN
7206CGD2/GLP4	30,000	62,000	16,000	0,190	2	NTN
7206CGD2/GNP4	30,000	62,000	16,000	0,190	2	NTN
7206CP5	30,000	62,000	16,000	0,190	2	NTN
7206T2G/GMP42	30,000	62,000	16,000	0,190	2	NTN
7206UCG/GNP42	30,000	62,000	16,000	0,190	2	NTN
7206CG1UJ74	30,000	62,000	16,000	0,209	2	SNR
7206HG1UJ74	30,000	62,000	16,000	0,203	2	SNR
7206CDB/GLP5	30,000	62,000	32,000	0,380	2	NTN
7206CDB/GMP5	30,000	62,000	32,000	0,380	2	NTN
7206T2DB/GMP5	30,000	62,000	32,000	0,380	2	NTN
7206CG1DUJ74	30,000	62,000	32,000	0,410	2	SNR
7206HG1DUJ74	30,000	62,000	32,000	0,411	2	SNR
5S-7207UCG/GNP42	35,000	72,000	17,000	0,270	2	NTN
7207CG/GNP4	35,000	72,000	17,000	0,270	2	NTN
7207CG/GNP42	35,000	72,000	17,000	0,270	2	NTN
7207CGD2/GLP4	35,000	72,000	17,000	0,270	2	NTN
7207T2G/GNP4	35,000	72,000	17,000	0,270	2	NTN
7207UCG/GNP42	35,000	72,000	17,000	0,270	2	NTN
7207CG1UJ74	35,000	72,000	17,000	0,296	2	SNR
7207HG1UJ74	35,000	72,000	17,000	0,300	2	SNR

Reference	d	D	B	Kg		Brands
7207CDB/GNP4	35,000	72,000	34,000	0,540	2	NTN
7207CDB/GNP5	35,000	72,000	34,000	0,540	2	NTN
7207T2DB/GNP5	35,000	72,000	34,000	0,540	2	NTN
7207CG1DUJ74	35,000	72,000	34,000	0,591	2	SNR
7207HG1DUJ74	35,000	72,000	34,000	0,590	2	SNR
5S-7208UCG/GNP42	40,000	80,000	18,000	0,350	2	NTN
7208CG/GNP4	40,000	80,000	18,000	0,350	2	NTN
7208CG/GNP42	40,000	80,000	18,000	0,350	2	NTN
7208CGD2/GLP4	40,000	80,000	18,000	0,350	2	NTN
7208T2G/GNP4	40,000	80,000	18,000	0,350	2	NTN
7208UCG/GNP42	40,000	80,000	18,000	0,350	2	NTN
7208CG1UJ74	40,000	80,000	18,000	0,374	2	SNR
7208HG1UJ74	40,000	80,000	18,000	0,377	2	SNR
7208CDB/GNP5	40,000	80,000	36,000	0,700	2	NTN
7208CG1DUJ74	40,000	80,000	36,000	0,744	2	SNR
7208HG1DUJ74	40,000	80,000	36,000	0,745	2	SNR
5S-7209UCG/GNP42	45,000	85,000	19,000	0,400	2	NTN
7209CDTP4	45,000	85,000	19,000	0,400	2	NTN
7209CG/GLP4	45,000	85,000	19,000	0,400	2	NTN
7209CG/GNP4	45,000	85,000	19,000	0,400	2	NTN
7209CG/GNP5	45,000	85,000	19,000	0,400	2	NTN
7209CG1GNP4	45,000	85,000	19,000	0,400	2	NTN
7209CGD2/GLP4	45,000	85,000	19,000	0,400	2	NTN
7209CGD2GLP4	45,000	85,000	19,000	0,400	2	NTN
7209UCG/GNP42	45,000	85,000	19,000	0,400	2	NTN
7209CG1UJ74	45,000	85,000	19,000	0,425	2	SNR
7209HG1UJ74	45,000	85,000	19,000	0,422	2	SNR
7209CDB/GNP5	45,000	85,000	38,000	0,800	2	NTN
7209CG1DUJ74	45,000	85,000	38,000	0,852	2	SNR
7209HG1DUJ74	45,000	85,000	38,000	0,841	2	SNR
5S-7210UCG/GNP42	50,000	90,000	20,000	0,450	2	NTN
7210CG/GLP4	50,000	90,000	20,000	0,450	2	NTN
7210CG/GMP4	50,000	90,000	20,000	0,450	2	NTN
7210CG/GNP4	50,000	90,000	20,000	0,450	2	NTN
7210CGD2/GLP4	50,000	90,000	20,000	0,450	2	NTN
7210CGD2/GNP4	50,000	90,000	20,000	0,450	2	NTN
7210CP4	50,000	90,000	20,000	0,450	2	NTN
7210T2G/GMP4	50,000	90,000	20,000	0,450	2	NTN
7210UCG/GNP42	50,000	90,000	20,000	0,450	2	NTN
7210CG1UJ74	50,000	90,000	20,000	0,478	2	SNR
7210HG1UJ74	50,000	90,000	20,000	0,480	2	SNR
7210CDB/GNP5	50,000	90,000	40,000	0,900	2	NTN
7210CG1DUJ74	50,000	90,000	40,000	0,955	2	SNR
7210HG1DUJ74	50,000	90,000	40,000	0,961	2	SNR
5S-7211UCG/GNP42	55,000	100,000	21,000	0,590	2	NTN
7211CG/GNP4	55,000	100,000	21,000	0,590	2	NTN
7211CGD2/GLP4	55,000	100,000	21,000	0,590	2	NTN
7211CGD2/GNP4	55,000	100,000	21,000	0,590	2	NTN
7211CT1G/GLP4	55,000	100,000	21,000	0,590	2	NTN
7211UCG/GNP42	55,000	100,000	21,000	0,590	2	NTN
7211CG1UJ74	55,000	100,000	21,000	0,630	2	SNR
7211HG1UJ74	55,000	100,000	21,000	0,620	2	SNR
7211CG1DUJ74	55,000	100,000	42,000	1,288	2	SNR
7211HG1DUJ74	55,000	100,000	42,000	1,240	2	SNR

Reference	d	D	B	Kg		Brands
5S-7212UCG/GNP42	60,000	110,000	22,000	0,760	2	NTN
7212CG/GNP4	60,000	110,000	22,000	0,760	2	NTN
7212CGD2/GNP4	60,000	110,000	22,000	0,760	2	NTN
7212UCG/GNP42	60,000	110,000	22,000	0,760	2	NTN
7212CG1UJ74	60,000	110,000	22,000	0,822	2	SNR
7212HG1UJ74	60,000	110,000	22,000	0,840	2	SNR
7212CG1DUJ74	60,000	110,000	44,000	1,643	2	SNR
7212HG1DUJ74	60,000	110,000	44,000	1,647	2	SNR
5S-7213UCG/GNP42	65,000	120,000	23,000	0,950	2	NTN
7213CG/GNP4	65,000	120,000	23,000	0,950	2	NTN
7213CG/GNP5	65,000	120,000	23,000	0,950	2	NTN
7213CGD2/GNP4	65,000	120,000	23,000	0,950	2	NTN
7213UCG/GNP42	65,000	120,000	23,000	0,950	2	NTN
7213CG1UJ74	65,000	120,000	23,000	1,034	2	SNR
7213HG1UJ74	65,000	120,000	23,000	1,032	2	SNR
7213CG1DUJ74	65,000	120,000	46,000	2,120	2	SNR
7213HG1DUJ74	65,000	120,000	46,000	2,120	2	SNR
5S-7214UCG/GNP42	70,000	125,000	24,000	1,040	2	NTN
7214CG/GLP4	70,000	125,000	24,000	1,040	2	NTN
7214CG/GNP4	70,000	125,000	24,000	1,040	2	NTN
7214T1P4	70,000	125,000	24,000	1,040	2	NTN
7214UCG/GNP42	70,000	125,000	24,000	1,040	2	NTN
7214CG1UJ74	70,000	125,000	24,000	1,123	2	SNR
7214HG1UJ74	70,000	125,000	24,000	1,080	2	SNR
7214CG1DUJ74	70,000	125,000	48,000	2,237	2	SNR
7214HG1DUJ74	70,000	125,000	48,000	2,252	2	SNR
5S-7215UCG/GNP42	75,000	130,000	25,000	1,140	2	NTN
7215CG/GNP4	75,000	130,000	25,000	1,140	2	NTN
7215CGD2/GNP4	75,000	130,000	25,000	1,140	2	NTN
7215CP5	75,000	130,000	25,000	1,140	2	NTN
7215UCG/GNP42	75,000	130,000	25,000	1,140	2	NTN
7215CG1UJ74	75,000	130,000	25,000	1,256	2	SNR
7215HG1UJ74	75,000	130,000	25,000	1,220	2	SNR
7215CG1DUJ74	75,000	130,000	50,000	2,508	2	SNR
7215HG1DUJ74	75,000	130,000	50,000	2,460	2	SNR
5S-7216UCG/GNP42	80,000	140,000	26,000	1,390	2	NTN
7216CG/GNP4	80,000	140,000	26,000	1,390	2	NTN
7216CGD2/GNP4	80,000	140,000	26,000	1,390	2	NTN
7216UCG/GNP42	80,000	140,000	26,000	1,390	2	NTN
7216CG1UJ74	80,000	140,000	26,000	1,532	2	SNR
7216HG1UJ74	80,000	140,000	26,000	1,540	2	SNR
7216CDB/GNP4	80,000	140,000	52,000	1,390	2	NTN
7216CG1DUJ74	80,000	140,000	52,000	3,069	2	SNR
7216HG1DUJ74	80,000	140,000	52,000	3,076	2	SNR
5S-7217UCG/GNP42	85,000	150,000	28,000	1,730	2	NTN
7217CG/GNP4	85,000	150,000	28,000	1,730	2	NTN
7217CGD2/GLP4	85,000	150,000	28,000	1,730	2	NTN
7217UCG/GNP42	85,000	150,000	28,000	1,730	2	NTN
7217CG120DUJ74	85,000	150,000	28,000	3,664	2	SNR
7217CG1UJ74	85,000	150,000	28,000	1,832	2	SNR
7217HG1UJ74	85,000	150,000	28,000	1,830	2	SNR

Reference	d	D	B	Kg		Brands
7217CG1DUJ74	85,000	150,000	56,000	3,657	2	SNR
7217HG1DUJ74	85,000	150,000	56,000	3,657	2	SNR
7217T1DB+6D/GNP4	85,000	150,000	62,000	3,830	2	NTN
5S-7218UCG/GNP42	90,000	160,000	30,000	2,130	2	NTN
7218CG/GLP4	90,000	160,000	30,000	2,130	2	NTN
7218CG/GNP4	90,000	160,000	30,000	2,130	2	NTN
7218UCG/GNP42	90,000	160,000	30,000	2,130	2	NTN
7218CG1UJ74	90,000	160,000	30,000	2,300	2	SNR
7218HG1UJ74	90,000	160,000	30,000	2,310	2	SNR
7218CG1DUJ74	90,000	160,000	60,000	4,569	2	SNR
7218HG1DUJ74	90,000	160,000	60,000	4,562	2	SNR
5S-7219UCG/GNP42	95,000	170,000	32,000	2,580	2	NTN
7219CG/GNP4	95,000	170,000	32,000	2,580	2	NTN
7219UCG/GNP42	95,000	170,000	32,000	2,580	2	NTN
5S-7220UCG/GNP42	100,000	180,000	34,000	3,210	2	NTN
7220CG/GLP4	100,000	180,000	34,000	3,210	2	NTN
7220CG/GNP4	100,000	180,000	34,000	3,210	2	NTN
7220UCG/GNP42	100,000	180,000	34,000	3,210	2	NTN
7220CG1UJ74	100,000	180,000	34,000	3,222	2	SNR
7220HG1UJ74	100,000	180,000	34,000	3,228	2	SNR
7220CDB/GNP5	100,000	180,000	68,000	6,420	2	NTN
7220CG1DUJ74	100,000	180,000	68,000	6,442	2	SNR
7220HG1DUJ74	100,000	180,000	68,000	6,446	2	SNR
5S-7221CT1B/GNP42	105,000	190,000	36,000	3,810	2	NTN
7221CT1B/GNP42	105,000	190,000	36,000	3,810	2	NTN
7222CT1B/GNP42	105,000	190,000	36,000	4,490	2	NTN
5S-7222CT1B/GNP42	110,000	200,000	38,000	4,500	2	NTN
7222CG1UJ74	110,000	200,000	38,000	4,562	2	SNR
7222HG1UJ74	110,000	200,000	38,000	4,582	2	SNR
7222CG1DUJ74	110,000	200,000	76,000	9,160	2	SNR
7222HG1DUJ74	110,000	200,000	76,000	9,312	2	SNR
5S-7224CT1B/GNP42	120,000	215,000	40,000	6,260	2	NTN
7224BP5	120,000	215,000	40,000	6,260	2	NTN
7224CP4	120,000	215,000	40,000	5,352	2	NTN
7224CP5	120,000	215,000	40,000	5,352	2	NTN
7224CT1B/GNP42	120,000	215,000	40,000	5,440	2	NTN
7224CG1UJ74	120,000	215,000	40,000	5,620	2	SNR
7224HG1UJ74	120,000	215,000	40,000	5,688	2	SNR
7224CDB/GMP5	120,000	215,000	80,000	10,704	2	NTN
7224CDB/GMP5/15K	120,000	215,000	80,000	10,704	2	NTN
7224CDB/GNP4	120,000	215,000	80,000	10,704	2	NTN
7224CDB/GNP5	120,000	215,000	80,000	10,704	2	NTN
7224CT2DB/GMP5	120,000	215,000	80,000	10,880	2	NTN
7224CT2DB/GMP5/15KQTHK	120,000	215,000	80,000	10,880	2	NTN
7224CG1DUJ74	120,000	215,000	80,000	11,224	2	SNR
7224HG1DUJ74	120,000	215,000	80,000	11,330	2	SNR
7224CDTBT/GMP5	120,000	215,000	160,000	20,640	2	NTN
7224CDTBT/GMP5/15K	120,000	215,000	160,000	21,760	2	NTN
7224CT2DTBT/GMP5	120,000	215,000	160,000	21,760	2	NTN
7224CT2DTBT/GMP5/15KQTHK	120,000	215,000	160,000	21,760	2	NTN

Reference	d	D	B	Kg		Brands
5S-7226CT1B/GNP42	130,000	230,000	40,000	5,830	2	NTN
7226CP4	130,000	230,000	40,000	5,830	2	NTN
7226CP5	130,000	230,000	40,000	5,830	2	NTN
7226CT1B/GNP42	130,000	230,000	40,000	6,190	2	NTN
7226P5	130,000	230,000	40,000	7,150	2	NTN
7226CDB/GNP5	130,000	230,000	80,000	11,660	2	NTN
7226DBP5V1	130,000	230,000	80,000	14,300	2	NTN
7228CP5	140,000	250,000	42,000	7,300	2	NTN
7230CP5	150,000	270,000	45,000	11,100	2	NTN
7232CP4	160,000	290,000	48,000	13,740	2	NTN
7232BDB+156/GNP5	160,000	290,000	252,000	49,849	2	NTN
7238CP5	190,000	340,000	55,000	21,300	2	NTN
7240DTP5	200,000	360,000	116,000	50,600	2	NTN
7240DB+30D2C3P5	200,000	360,000	146,000	57,700	2	NTN
7256BP4	280,000	500,000	160,000	114,000	2	NTN
7302CDB/GNP5	15,000	42,000	26,000	0,162	2	NTN
7303CGD2/GNP4	17,000	47,000	14,000	0,220	2	NTN
7304CGD2/GNP4	20,000	52,000	15,000	0,278	2	NTN
7305CGD2/GNP4	25,000	62,000	17,000	0,450	2	NTN
7307CDB/GLP4	35,000	80,000	42,000	0,896	2	NTN
7308CG/GNP4	40,000	90,000	23,000	0,613	2	NTN
7308CP5	40,000	90,000	23,000	0,613	2	NTN
7317BF1GP5	85,000	180,000	41,000	4,920	2	NTN
7320BF1GP5	100,000	215,000	47,000	7,090	2	NTN
7320CP5	100,000	215,000	47,000	6,900	2	NTN
7320CDB/GNP5	100,000	215,000	94,000	13,800	2	NTN
7320L1DBP5	100,000	215,000	94,000	14,360	2	NTN
7320T1DT+16P5	100,000	215,000	110,000	16,600	2	NTN
7320T1DFTP5+TKZ0126	100,000	215,000	151,300	20,741	2	NTN
7322CP5	110,000	240,000	50,000	9,588	2	NTN
7322L1P5	110,000	240,000	50,000	9,470	2	NTN
7322CDB/GNP5	110,000	240,000	100,000	19,176	2	NTN
7322L1DBP5	110,000	240,000	100,000	10,749	2	NTN
7322T1DBCS115P5	110,000	240,000	100,000	19,000	2	NTN
7326BF3DFC3P5	130,000	280,000	116,000	35,100	2	NTN
7334DBC3P5	170,000	360,000	144,000	71,600	2	NTN
5S-7805CG/GNP42	25,000	37,000	7,000	0,021	2	NTN
7805CG/GNP42	25,000	37,000	7,000	0,021	2	NTN
5S-7806CG/GNP42	30,000	42,000	7,000	0,025	2	NTN
7806CG/GNP42	30,000	42,000	7,000	0,025	2	NTN
7806CEX1DB+33D2P4V3	30,000	42,000	14,000	0,050	2	NTN
5S-7807CG/GNP42	35,000	47,000	7,000	0,028	2	NTN
7807CG/GNP42	35,000	47,000	7,000	0,028	2	NTN
7807CDB/GNP4	35,000	47,000	14,000	0,056	2	NTN
5S-7808CG/GNP42	40,000	52,000	7,000	0,031	2	NTN
7808CG/GNP42	40,000	52,000	7,000	0,031	2	NTN
5S-7809CG/GNP42	45,000	58,000	7,000	0,039	2	NTN
7809CG/GNP42	45,000	58,000	7,000	0,039	2	NTN
5S-7810CG/GNP42	50,000	65,000	7,000	0,049	2	NTN
7810CG/GNP4	50,000	65,000	7,000	0,049	2	NTN
7810CG/GNP42	50,000	65,000	7,000	0,049	2	NTN
5S-7811CG/GNP42	55,000	72,000	9,000	0,079	2	NTN

Reference	d	D	B	Kg		Brands
7811CG/GNP4	55,000	72,000	9,000	0,079	2	NTN
7811CG/GNP42	55,000	72,000	9,000	0,079	2	NTN
7811T1G/GMUP-1	55,000	72,000	9,000	0,079	2	NTN
5S-7812CG/GNP42	60,000	78,000	10,000	0,100	2	NTN
7812 CG/GN P4	60,000	78,000	10,000	0,100	2	NTN
7812CG/GNP4	60,000	78,000	10,000	0,100	2	NTN
7812CG/GNP42	60,000	78,000	10,000	0,100	2	NTN
7812G/GMP42	60,000	78,000	10,000	0,100	2	NTN
5S-7813CG/GNP42	65,000	85,000	10,000	0,120	2	NTN
7813CG/GNP4	65,000	85,000	10,000	0,120	2	NTN
7813CG/GNP42	65,000	85,000	10,000	0,120	2	NTN
5S-7814CG/GNP42	70,000	90,000	10,000	0,130	2	NTN
7814CG/GNP42	70,000	90,000	10,000	0,130	2	NTN
7814CDB/GNP4	70,000	90,000	20,000	0,260	2	NTN
5S-7815CG/GNP42	75,000	95,000	10,000	0,140	2	NTN
7815CG/GNP4	75,000	95,000	10,000	0,140	2	NTN
7815CG/GNP42	75,000	95,000	10,000	0,140	2	NTN
7815G/GMP4	75,000	95,000	10,000	0,140	2	NTN
7815G/GMP42	75,000	95,000	10,000	0,140	2	NTN
5S-7816CG/GNP42	80,000	100,000	10,000	0,150	2	NTN
7816CG/GNP4	80,000	100,000	10,000	0,150	2	NTN
7816CG/GNP42	80,000	100,000	10,000	0,150	2	NTN
7816CG/GNUP-1	80,000	100,000	10,000	0,150	2	NTN
7816T1G/GMP4	80,000	100,000	10,000	0,150	2	NTN
5S-7817CG/GNP42	85,000	110,000	13,000	0,260	2	NTN
7817CG/GNP42	85,000	110,000	13,000	0,260	2	NTN
5S-7818CG/GNP42	90,000	115,000	13,000	0,270	2	NTN
7818CG/GNP4	90,000	115,000	13,000	0,270	2	NTN
7818CG/GNP42	90,000	115,000	13,000	0,270	2	NTN
7818CDB/GNP5	90,000	115,000	26,000	0,540	2	NTN
5S-7819CG/GNP42	95,000	120,000	13,000	0,280	2	NTN
7819CG/GNP4	95,000	120,000	13,000	0,280	2	NTN
7819CG/GNP42	95,000	120,000	13,000	0,280	2	NTN
5S-7820CG/GNP42	100,000	125,000	13,000	0,300	2	NTN
7820CG/GNP4	100,000	125,000	13,000	0,300	2	NTN
7820CG/GNP42	100,000	125,000	13,000	0,300	2	NTN
7820CDB/G019UP-5	100,000	125,000	26,000	0,600	2	NTN
5S-7821CG/GNP42	105,000	130,000	13,000	0,310	2	NTN
7821CG/GNP42	105,000	130,000	13,000	0,310	2	NTN
5S-7822CG/GNP42	110,000	140,000	16,000	0,490	2	NTN
7822CG/GNP4	110,000	140,000	16,000	0,490	2	NTN
7822CG/GNP42	110,000	140,000	16,000	0,490	2	NTN
7822CP4	110,000	140,000	16,000	0,490	2	NTN
7822CDB/G20P4	110,000	140,000	32,000	0,980	2	NTN
5S-7824CG/GNP42	120,000	150,000	16,000	0,520	2	NTN
7824CG/GNP4	120,000	150,000	16,000	0,520	2	NTN
7824CG/GNP42	120,000	150,000	16,000	0,520	2	NTN
5S-7826CG/GNP42	130,000	165,000	18,000	0,910	2	NTN

Reference	d	D	B	Kg		Brands
7826CG/GNP42	130,000	165,000	18,000	0,910	2	NTN
7826CT1P4	130,000	165,000	18,000	0,910	2	NTN
5S-7828CG/GNP42	140,000	175,000	18,000	0,970	2	NTN
7828CG/GNP42	140,000	175,000	18,000	0,970	2	NTN
5S-7830CG/GNP42	150,000	190,000	20,000	1,330	2	NTN
7830CG/GNP42	150,000	190,000	20,000	1,330	2	NTN
7830CT1P4	150,000	190,000	20,000	1,330	2	NTN
7830CT1UP	150,000	190,000	20,000	1,330	2	NTN
5S-7832CG/GNP42	160,000	200,000	20,000	1,410	2	NTN
7832CG/GNP42	160,000	200,000	20,000	1,410	2	NTN
5S-7834CG/GNP42	170,000	215,000	22,000	1,870	2	NTN
7834CG/GNP42	170,000	215,000	22,000	1,870	2	NTN
7934CDBT/GNP4	170,000	230,000	112,000	13,000	2	NTN
7836DF+16D3CS25-1P5	180,000	225,000	60,000	4,560	2	NTN
5S-7900ADLLBG/GNP42	10,000	22,000	6,000	0,009	2	NTN
5S-7900CDLLBG/GNP42	10,000	22,000	6,000	0,009	2	NTN
5S-7900UADG/GNP42	10,000	22,000	6,000	0,009	2	NTN
5S-7900UCG/GNP42	10,000	22,000	6,000	0,009	2	NTN
7900ADLLBG/GNP42	10,000	22,000	6,000	0,010	2	NTN
7900CDLLBG/GNP42	10,000	22,000	6,000	0,010	2	NTN
7900UADG/GNP42	10,000	22,000	6,000	0,010	2	NTN
7900UCG/GNP4	10,000	22,000	6,000	0,010	2	NTN
7900UCG/GNP42	10,000	22,000	6,000	0,010	2	NTN
7900UG/GMP42/L606Q1	10,000	22,000	6,000	0,010	2	NTN
71900CVUJ74	10,000	22,000	6,000	0,015	2	SNR
ML71900CVUJ74S	10,000	22,000	6,000	0,180	2	SNR
MLE71900CVUJ74S	10,000	22,000	6,000	0,016	2	SNR
71900CVDUJ74	10,000	22,000	12,000	0,027	2	SNR
71900HVDUJ74	10,000	22,000	12,000	0,028	2	SNR
ML71900CVDUJ74S	10,000	22,000	12,000	0,026	2	SNR
ML71900HVDUJ74S	10,000	22,000	12,000	0,032	2	SNR
MLE71900CVDUJ74S	10,000	22,000	12,000	0,032	2	SNR
MLE71900HVDUJ74S	10,000	22,000	12,000	0,032	2	SNR
MLE71900HVUJ74S	10,000	22,000	12,000	0,019	2	SNR
5S-7901ADLLBG/GNP42	12,000	24,000	6,000	0,011	2	NTN
5S-7901CDLLBG/GNP42	12,000	24,000	6,000	0,011	2	NTN
5S-7901UADG/GNP42	12,000	24,000	6,000	0,011	2	NTN
5S-7901UCG/GNP42	12,000	24,000	6,000	0,011	2	NTN
7901ADLLBG/GNP42	12,000	24,000	6,000	0,010	2	NTN
7901CDLLBG/GNP42	12,000	24,000	6,000	0,010	2	NTN
7901CG/GNP4	12,000	24,000	6,000	0,010	2	NTN
7901UADG/GNP42	12,000	24,000	6,000	0,010	2	NTN
7901UCG/GLP4	12,000	24,000	6,000	0,010	2	NTN
7901UCG/GNP4	12,000	24,000	6,000	0,010	2	NTN
7901UCG/GNP42	12,000	24,000	6,000	0,010	2	NTN
7901UG/GMP42/L606Q1	12,000	24,000	6,000	0,010	2	NTN
71901CVUJ74	12,000	24,000	6,000	0,017	2	SNR
71901HVUJ74	12,000	24,000	6,000	0,016	2	SNR
ML71901CVUJ74S	12,000	24,000	6,000	0,016	2	SNR
ML71901HVUJ74S	12,000	24,000	6,000	0,026	2	SNR
MLE71901CVUJ74S	12,000	24,000	6,000	0,021	2	SNR
MLE71901HVUJ74S	12,000	24,000	6,000	0,016	2	SNR
71901CVDUJ74	12,000	24,000	12,000	0,040	2	SNR

Reference	d	D	B	Kg	?	Brands
71901HVDUJ74	12,000	24,000	12,000	0,290	2	SNR
ML71901CVDUJ74S	12,000	24,000	12,000	0,028	2	SNR
ML71901HVDUJ74S	12,000	24,000	12,000	0,052	2	SNR
MLE71901CVDUJ74S	12,000	24,000	12,000	0,052	2	SNR
MLE71901HVDUJ74S	12,000	24,000	12,000	0,052	2	SNR
5S-7902ADLLBG/GNP42	15,000	28,000	7,000	0,015	2	NTN
5S-7902CDLLBG/GNP42	15,000	28,000	7,000	0,015	2	NTN
5S-7902UADG/GNP42	15,000	28,000	7,000	0,015	2	NTN
5S-7902UCG/GNP42	15,000	28,000	7,000	0,015	2	NTN
7902ADLLBG/GNP42	15,000	28,000	7,000	0,020	2	NTN
7902CDLLBG/GNP42	15,000	28,000	7,000	0,020	2	NTN
7902T2G/GMP4	15,000	28,000	7,000	0,020	2	NTN
7902T2G/GMP4/15KQTQ	15,000	28,000	7,000	0,020	2	NTN
7902UADG/GNP42	15,000	28,000	7,000	0,020	2	NTN
7902UCG/GMP42	15,000	28,000	7,000	0,020	2	NTN
7902UCG/GNP4	15,000	28,000	7,000	0,020	2	NTN
7902UCG/GNP42	15,000	28,000	7,000	0,020	2	NTN
7902UG/GMP4	15,000	28,000	7,000	0,020	2	NTN
7902UG/GMP42/L606Q1	15,000	28,000	7,000	0,020	2	NTN
71902CVUJ74	15,000	28,000	7,000	0,022	2	SNR
71902HVUJ74	15,000	28,000	7,000	0,020	2	SNR
ML71902CVUJ74S	15,000	28,000	7,000	0,022	2	SNR
ML71902HVUJ74S	15,000	28,000	7,000	0,020	2	SNR
MLE71902CVUJ74S	15,000	28,000	7,000	0,022	2	SNR
MLE71902HVUJ74S	15,000	28,000	7,000	0,020	2	SNR
71902CVDUJ74	15,000	28,000	14,000	0,036	2	SNR
71902HVDUJ74	15,000	28,000	14,000	0,036	2	SNR
ML71902CVDUJ74S	15,000	28,000	14,000	0,038	2	SNR
ML71902HVDUJ74S	15,000	28,000	14,000	0,040	2	SNR
MLE71902CVDUJ74S	15,000	28,000	14,000	0,040	2	SNR
MLE71902HVDUJ74S	15,000	28,000	14,000	0,040	2	SNR
5S-7903ADLLBG/GNP42	17,000	30,000	7,000	0,017	2	NTN
5S-7903CDLLBG/GNP42	17,000	30,000	7,000	0,017	2	NTN
5S-7903UADG/GNP42	17,000	30,000	7,000	0,017	2	NTN
5S-7903UCG/GNP42	17,000	30,000	7,000	0,017	2	NTN
7903ADLLBG/GNP42	17,000	30,000	7,000	0,020	2	NTN
7903CDLLBG/GNP42	17,000	30,000	7,000	0,020	2	NTN
7903CG/GMP4	17,000	30,000	7,000	0,020	2	NTN
7903CT1G/GMP42	17,000	30,000	7,000	0,020	2	NTN
7903T1G/GMP4/15KQQ	17,000	30,000	7,000	0,020	2	NTN
7903UADG/GNP42	17,000	30,000	7,000	0,020	2	NTN
7903UCG/GNP4	17,000	30,000	7,000	0,020	2	NTN
7903UCG/GNP42	17,000	30,000	7,000	0,020	2	NTN
7903UG/GMP4	17,000	30,000	7,000	0,020	2	NTN
7903UG/GMP4/15KQTQ	17,000	30,000	7,000	0,020	2	NTN
7903UG/GMP42/L606Q1	17,000	30,000	7,000	0,020	2	NTN
7903UG/GNP42/L606Q1	17,000	30,000	7,000	0,020	2	NTN
71903CVUJ74	17,000	30,000	7,000	0,021	2	SNR
71903HVUJ74	17,000	30,000	7,000	0,024	2	SNR
ML71903CVUJ74S	17,000	30,000	7,000	0,022	2	SNR
MLE71903CVUJ74S	17,000	30,000	7,000	0,026	2	SNR

Reference	d	D	B	Kg	?	Brands
MLE71903HVUJ74S	17,000	30,000	7,000	0,024	2	SNR
71903CVDUJ74	17,000	30,000	14,000	0,040	2	SNR
71903HVDUJ74	17,000	30,000	14,000	0,040	2	SNR
ML71903CVDUJ74S	17,000	30,000	14,000	0,042	2	SNR
ML71903HVDUJ74S	17,000	30,000	14,000	0,042	2	SNR
MLE71903CVDUJ74S	17,000	30,000	14,000	0,042	2	SNR
MLE71903HVDUJ74S	17,000	30,000	14,000	0,042	2	SNR
2LA-HSE904ADG/GNP42	20,000	37,000	9,000	0,033	2	NTN
2LA-HSE904CG/GNP42	20,000	37,000	9,000	0,033	2	NTN
5S-2LA-HSE904ADG/GNP42	20,000	37,000	9,000	0,033	2	NTN
5S-2LA-HSE904CG/GNP42	20,000	37,000	9,000	0,033	2	NTN
5S-7904ADLLBG/GNP42	20,000	37,000	9,000	0,036	2	NTN
5S-7904CDLLBG/GNP42	20,000	37,000	9,000	0,036	2	NTN
5S-7904UADG/GNP42	20,000	37,000	9,000	0,036	2	NTN
5S-7904UCG/GNP42	20,000	37,000	9,000	0,036	2	NTN
7904ADLLBG/GNP42	20,000	37,000	9,000	0,040	2	NTN
7904CDLLBG/GNP42	20,000	37,000	9,000	0,040	2	NTN
7904CG/GMP4/15KQTQ	20,000	37,000	9,000	0,040	2	NTN
7904T1G/GNP4	20,000	37,000	9,000	0,040	2	NTN
7904UADG/G4UP-5	20,000	37,000	9,000	0,040	2	NTN
7904UADG/GNP42	20,000	37,000	9,000	0,040	2	NTN
7904UCG/GMP4	20,000	37,000	9,000	0,040	2	NTN
7904UCG/GNP4	20,000	37,000	9,000	0,040	2	NTN
7904UCG/GNP42	20,000	37,000	9,000	0,040	2	NTN
7904UCG/G2/GLP4	20,000	37,000	9,000	0,040	2	NTN
7904UG/GMP42	20,000	37,000	9,000	0,040	2	NTN
7904UG/GMP42/L606Q1	20,000	37,000	9,000	0,040	2	NTN
71904CVUJ74	20,000	37,000	9,000	0,041	2	SNR
71904HVUJ74	20,000	37,000	9,000	0,041	2	SNR
ML71904CVUJ74S	20,000	37,000	9,000	0,042	2	SNR
ML71904HVUJ74S	20,000	37,000	9,000	0,042	2	SNR
MLE71904CVUJ74S	20,000	37,000	9,000	0,040	2	SNR
MLE71904HVUJ74S	20,000	37,000	9,000	0,042	2	SNR
71904CVDUJ74	20,000	37,000	18,000	0,080	2	SNR
71904HVDUJ74	20,000	37,000	18,000	0,080	2	SNR
ML71904CVDUJ74S	20,000	37,000	18,000	0,080	2	SNR
ML71904HVDUJ74S	20,000	37,000	18,000	0,080	2	SNR
MLE71904CVDUJ74S	20,000	37,000	18,000	0,080	2	SNR
MLE71904HVDUJ74S	20,000	37,000	18,000	0,090	2	SNR
7904UCB+8/GNP5	20,000	37,000	26,000	0,080	2	NTN
2LA-HSE905ADG/GNP42	25,000	42,000	9,000	0,039	2	NTN
2LA-HSE905CG/GNP42	25,000	42,000	9,000	0,039	2	NTN
5S-2LA-HSE905ADG/GNP42	25,000	42,000	9,000	0,039	2	NTN
5S-2LA-HSE905CG/GNP42	25,000	42,000	9,000	0,039	2	NTN
5S-7905ADLLBG/GNP42	25,000	42,000	9,000	0,042	2	NTN
5S-7905CDLLBG/GNP42	25,000	42,000	9,000	0,042	2	NTN
5S-7905UADG/GNP42	25,000	42,000	9,000	0,042	2	NTN
5S-7905UCG/GNP42	25,000	42,000	9,000	0,042	2	NTN
7905ADLLBG/GNP42	25,000	42,000	9,000	0,040	2	NTN

Reference	d	D	B	Kg	?	Brands
7905CDLLBG/GNP42	25,000	42,000	9,000	0,040	2	NTN
7905G/GMP4	25,000	42,000	9,000	0,040	2	NTN
7905G/GMUP-3/L606Q1	25,000	42,000	9,000	0,040	2	NTN
7905UADG/GNP42	25,000	42,000	9,000	0,040	2	NTN
7905UCG/GNP4	25,000	42,000	9,000	0,040	2	NTN
7905UCG/GNP4/15KQTQ	25,000	42,000	9,000	0,040	2	NTN
7905UCG/GNP42	25,000	42,000	9,000	0,040	2	NTN
7905UG/GHP4/15KQTQ	25,000	42,000	9,000	0,040	2	NTN
7905UG/GMP4/15KQTQ	25,000	42,000	9,000	0,040	2	NTN
7905UG/GMP42	25,000	42,000	9,000	0,040	2	NTN
7905UG/GMP42/L606Q1	25,000	42,000	9,000	0,040	2	NTN
7905UG/GNP42/L606Q1	25,000	42,000	9,000	0,040	2	NTN
71905CVUJ74	25,000	42,000	9,000	0,049	2	SNR
71905HVUJ74	25,000	42,000	9,000	0,048	2	SNR
ML71905CVUJ74S	25,000	42,000	9,000	0,048	2	SNR
ML71905HVUJ74S	25,000	42,000	9,000	0,040	2	SNR
MLE71905CVUJ74S	25,000	42,000	9,000	0,052	2	SNR
MLE71905HVUJ74S	25,000	42,000	9,000	0,048	2	SNR
71905CVDUJ74	25,000	42,000	18,000	0,090	2	SNR
71905HVDUJ74	25,000	42,000	18,000	0,089	2	SNR
ML71905CVDUJ74S	25,000	42,000	18,000	0,086	2	SNR
ML71905HVDUJ74S	25,000	42,000	18,000	0,086	2	SNR
MLE71905CVDUJ74S	25,000	42,000	18,000	0,096	2	SNR
MLE71905HVDUJ74S	25,000	42,000	18,000	0,104	2	SNR
2LA-HSE906ADG/GNP42	30,000	47,000	9,000	0,044	2	NTN
2LA-HSE906CG/GNP42	30,000	47,000	9,000	0,044	2	NTN
5S-2LA-HSE906ADG/GNP42	30,000	47,000	9,000	0,044	2	NTN
5S-2LA-HSE906CG/GNP42	30,000	47,000	9,000	0,044	2	NTN
5S-7906ADLLBG/GNP42	30,000	47,000	9,000	0,048	2	NTN
5S-7906CDLLBG/GNP42	30,000	47,000	9,000	0,048	2	NTN
5S-7906UADG/GNP42	30,000	47,000	9,000	0,048	2	NTN
5S-7906UCG/GNP42	30,000	47,000	9,000	0,048	2	NTN
7906ADLLBG/GNP42	30,000	47,000	9,000	0,050	2	NTN
7906CDLLBG/GLP42/L749	30,000	47,000	9,000	0,050	2	NTN
7906CDLLBG/GNP42	30,000	47,000	9,000	0,050	2	NTN
7906CG/GNP4	30,000	47,000	9,000	0,050	2	NTN
7906G/GMP42	30,000	47,000	9,000	0,050	2	NTN
7906G/GNP42/15KQTGH	30,000	47,000	9,000	0,050	2	NTN
7906UADG/GNP42	30,000	47,000	9,000	0,050	2	NTN
7906UCG/GNP4	30,000	47,000	9,000	0,050	2	NTN
7906UCG/GNP42	30,000	47,000	9,000	0,050	2	NTN
7906UCP4	30,000	47,000	9,000	0,050	2	NTN
7906UG/GMP4	30,000	47,000	9,000	0,050	2	NTN
7906UG/GMP4/15KQTQ	30,000	47,000	9,000	0,050	2	NTN
71906CVUJ74	30,000	47,000	9,000	0,054	2	SNR
71906HVUJ74	30,000	47,000	9,000	0,054	2	SNR
ML71906CVUJ74S	30,000	47,000	9,000	0,056	2	SNR
ML71906HVUJ74S	30,000	47,000	9,000	0,056	2	SNR
MLE71906CVUJ74S	30,000	47,000	9,000	0,060	2	SNR
MLE71906HVUJ74S	30,000	47,000	9,000	0,058	2	SNR
71906CVDUJ74	30,000	47,000	18,000	0,104	2	SNR

Reference	d	D	B	Kg	?	Brands
71906HVDUJ74	30,000	47,000	18,000	0,106	2	SNR
ML71906CVDUJ74S	30,000	47,000	18,000	0,106	2	SNR
ML71906HVDUJ74S	30,000	47,000	18,000	0,106	2	SNR
MLE71906CVDUJ74S	30,000	47,000	18,000	0,112	2	SNR
MLE71906HVDUJ74S	30,000	47,000	18,000	0,112	2	SNR
2LA-HSE907ADG/GNP42	35,000	55,000	10,000	0,062	2	NTN
2LA-HSE907CG/GNP42	35,000	55,000	10,000	0,062	2	NTN
5S-2LA-HSE907ADG/GNP42	35,000	55,000	10,000	0,062	2	NTN
5S-2LA-HSE907CG/GNP42	35,000	55,000	10,000	0,062	2	NTN
5S-7907ADLLBG/GNP42	35,000	55,000	10,000	0,073	2	NTN
5S-7907CDLLBG/GNP42	35,000	55,000	10,000	0,073	2	NTN
5S-7907UADG/GNP42	35,000	55,000	10,000	0,073	2	NTN
5S-7907UCG/GNP42	35,000	55,000	10,000	0,073	2	NTN
7907ADLLBG/GNP42	35,000	55,000	10,000	0,070	2	NTN
7907CDLLBG/GNP42	35,000	55,000	10,000	0,070	2	NTN
7907CG/GNP4	35,000	55,000	10,000	0,070	2	NTN
7907UADG/GNP42	35,000	55,000	10,000	0,070	2	NTN
7907UCG/GNP4	35,000	55,000	10,000	0,070	2	NTN
7907UCG/GNP42	35,000	55,000	10,000	0,070	2	NTN
7907UG/GMP42	35,000	55,000	10,000	0,070	2	NTN
7907UG/GNP42	35,000	55,000	10,000	0,070	2	NTN
7907UG/GNP42/15KQTQ	35,000	55,000	10,000	0,070	2	NTN
71907CVUJ74	35,000	55,000	10,000	0,083	2	SNR
71907HVUJ74	35,000	55,000	10,000	0,079	2	SNR
ML71907CVUJ74S	35,000	55,000	10,000	0,082	2	SNR
ML71907HVUJ74S	35,000	55,000	10,000	0,086	2	SNR
MLE71907CVUJ74S	35,000	55,000	10,000	0,088	2	SNR
MLE71907HVUJ74S	35,000	55,000	10,000	0,092	2	SNR
7907DBP5	35,000	55,000	20,000	0,140	2	NTN
71907CVDUJ74	35,000	55,000	20,000	0,180	2	SNR
71907HVDUJ74	35,000	55,000	20,000	0,161	2	SNR
ML71907CVDUJ74S	35,000	55,000	20,000	0,162	2	SNR
ML71907HVDUJ74S	35,000	55,000	20,000	0,162	2	SNR
MLE71907CVDUJ74S	35,000	55,000	20,000	0,174	2	SNR
MLE71907HVDUJ74S	35,000	55,000	20,000	0,162	2	SNR
71907CVUJ74	35,000	55,000	40,000	0,324	2	SNR
2LA-HSE908ADG/GNP42	40,000	62,000	12,000	0,100	2	NTN
2LA-HSE908CG/GNP42	40,000	62,000	12,000	0,100	2	NTN
5S-2LA-HSE908ADG/GNP42	40,000	62,000	12,000	0,100	2	NTN
5S-2LA-HSE908CG/GNP42	40,000	62,000	12,000	0,100	2	NTN
5S-7908ADLLBG/GNP42	40,000	62,000	12,000	0,099	2	NTN
5S-7908CDLLBG/GNP42	40,000	62,000	12,000	0,099	2	NTN
5S-7908UADG/GNP42	40,000	62,000	12,000	0,099	2	NTN
5S-7908UCG/GNP42	40,000	62,000	12,000	0,099	2	NTN
5S-HSB908GCS00P42	40,000	62,000	12,000	0,220	2	NTN
7908ADLLBG/GNP42	40,000	62,000	12,000	0,110	2	NTN
7908CDLLBG/GNP42	40,000	62,000	12,000	0,110	2	NTN
7908CGD2/GLP4	40,000	62,000	12,000	0,110	2	NTN

Reference	d	D	B	Kg	?	Brands
7908UADG/G7UP-4	40,000	62,000	12,000	0,110	2	NTN
7908UADG/GNP42	40,000	62,000	12,000	0,110	2	NTN
7908UCG/GNP4	40,000	62,000	12,000	0,110	2	NTN
7908UCG/GNP42	40,000	62,000	12,000	0,110	2	NTN
7908UCG/GNUP-2	40,000	62,000	12,000	0,110	2	NTN
7908UCGD2/GLP4	40,000	62,000	12,000	0,110	2	NTN
7908UG/GMP4	40,000	62,000	12,000	0,110	2	NTN
7908UG/GMP4/15KQTQ	40,000	62,000	12,000	0,110	2	NTN
71908CVUJ74	40,000	62,000	12,000	0,116	2	SNR
71908HVUJ74	40,000	62,000	12,000	0,120	2	SNR
ML71908CVUJ74S	40,000	62,000	12,000	0,116	2	SNR
ML71908HVUJ74S	40,000	62,000	12,000	0,120	2	SNR
MLE71908CVUJ74S	40,000	62,000	12,000	0,124	2	SNR
MLE71908HVUJ74S	40,000	62,000	12,000	0,130	2	SNR
71908CVDUJ74	40,000	62,000	24,000	0,230	2	SNR
71908HVDUJ74	40,000	62,000	24,000	0,228	2	SNR
ML71908CVDUJ74S	40,000	62,000	24,000	0,236	2	SNR
ML71908HVDUJ74S	40,000	62,000	24,000	0,232	2	SNR
MLE71908CVDUJ74S	40,000	62,000	24,000	0,232	2	SNR
MLE71908HVDUJ74S	40,000	62,000	24,000	0,264	2	SNR
2LA-HSE909ADG/GNP42	45,000	68,000	12,000	0,110	2	NTN
2LA-HSE909CG/GNP42	45,000	68,000	12,000	0,110	2	NTN
5S-2LA-HSE909ADG/GNP42	45,000	68,000	12,000	0,110	2	NTN
5S-2LA-HSE909CG/GNP42	45,000	68,000	12,000	0,110	2	NTN
5S-7909ADLLBG/GNP42	45,000	68,000	12,000	0,120	2	NTN
5S-7909CDLLBG/GNP42	45,000	68,000	12,000	0,120	2	NTN
5S-7909UADG/GNP42	45,000	68,000	12,000	0,120	2	NTN
5S-7909UCG/GNP42	45,000	68,000	12,000	0,120	2	NTN
7909ADLLBG/GNP42	45,000	68,000	12,000	0,120	2	NTN
7909CDLLBG/GNP42	45,000	68,000	12,000	0,120	2	NTN
7909CG/GLP4	45,000	68,000	12,000	0,120	2	NTN
7909CG/GNP4	45,000	68,000	12,000	0,120	2	NTN
7909UADG/GNP42	45,000	68,000	12,000	0,120	2	NTN
7909UCG/GNP4	45,000	68,000	12,000	0,120	2	NTN
7909UCG/GNP42	45,000	68,000	12,000	0,120	2	NTN
7909UG/GMP42	45,000	68,000	12,000	0,120	2	NTN
71909CVUJ74	45,000	68,000	12,000	0,140	2	SNR
71909HVUJ74	45,000	68,000	12,000	0,140	2	SNR
ML71909CVUJ74S	45,000	68,000	12,000	0,144	2	SNR
ML71909HVUJ74S	45,000	68,000	12,000	0,146	2	SNR
MLE71909CVUJ74S	45,000	68,000	12,000	0,158	2	SNR
MLE71909HVUJ74S	45,000	68,000	12,000	0,150	2	SNR
71909CVDUJ74	45,000	68,000	24,000	0,281	2	SNR
71909HVDUJ74	45,000	68,000	24,000	0,272	2	SNR
ML71909CVDUJ74S	45,000	68,000	24,000	0,280	2	SNR
ML71909HVDUJ74S	45,000	68,000	24,000	0,280	2	SNR
MLE71909CVDUJ74S	45,000	68,000	24,000	0,340	2	SNR
MLE71909HVDUJ74S	45,000	68,000	24,000	0,280	2	SNR
2LA-BNS910ADLLBG/GNP42	50,000	72,000	12,000	0,140	2	NTN
2LA-BNS910CLLLBG/GNP42	50,000	72,000	12,000	0,140	2	NTN

Reference	d	D	B	Kg	?	Brands
2LA-BNS910LLBG/GNP42	50,000	72,000	12,000	0,140	2	NTN
2LA-HSE910ADG/GNP42	50,000	72,000	12,000	0,140	2	NTN
2LA-HSE910CG/GNP42	50,000	72,000	12,000	0,140	2	NTN
2LA-HSE910G/GNP42	50,000	72,000	12,000	0,140	2	NTN
5S-2LA-BNS910ADLLBG/GNP42	50,000	72,000	12,000	0,140	2	NTN
5S-2LA-BNS910CLLLBG/GNP42	50,000	72,000	12,000	0,140	2	NTN
5S-2LA-BNS910LLBG/GNP42	50,000	72,000	12,000	0,140	2	NTN
5S-2LA-HSE910ADG/GNP42	50,000	72,000	12,000	0,130	2	NTN
5S-2LA-HSE910CG/GNP42	50,000	72,000	12,000	0,130	2	NTN
5S-2LA-HSE910G/GNP42	50,000	72,000	12,000	0,130	2	NTN
5S-7910ADLLBG/GNP42	50,000	72,000	12,000	0,120	2	NTN
5S-7910CDLLBG/GNP42	50,000	72,000	12,000	0,120	2	NTN
5S-7910UADG/GNP42	50,000	72,000	12,000	0,120	2	NTN
5S-7910UCG/GNP42	50,000	72,000	12,000	0,120	2	NTN
7910ADLLBG/GNP42	50,000	72,000	12,000	0,130	2	NTN
7910CDLLBG/GNP42	50,000	72,000	12,000	0,130	2	NTN
7910UADG/G8UP-5	50,000	72,000	12,000	0,130	2	NTN
7910UADG/GNP42	50,000	72,000	12,000	0,130	2	NTN
7910UCG/GNP4	50,000	72,000	12,000	0,130	2	NTN
7910UCG/GNP42	50,000	72,000	12,000	0,130	2	NTN
7910UG/GMP42	50,000	72,000	12,000	0,130	2	NTN
71910CVUJ74	50,000	72,000	12,000	0,150	2	SNR
71910HVUJ74	50,000	72,000	12,000	0,140	2	SNR
ML71910CVUJ74S	50,000	72,000	12,000	0,152	2	SNR
ML71910HVUJ74S	50,000	72,000	12,000	0,150	2	SNR
MLE71910CVUJ74S	50,000	72,000	12,000	0,158	2	SNR
MLE71910HVUJ74S	50,000	72,000	12,000	0,154	2	SNR
7910CDB/GNP4	50,000	72,000	24,000	0,260	2	NTN
71910CVDUJ74	50,000	72,000	24,000	0,275	2	SNR
71910HVDUJ74	50,000	72,000	24,000	0,287	2	SNR
ML71910CVDUJ74S	50,000	72,000	24,000	0,282	2	SNR
ML71910HVDUJ74S	50,000	72,000	24,000	0,340	2	SNR
MLE71910CVDUJ74S	50,000	72,000	24,000	0,340	2	SNR
MLE71910HVDUJ74S	50,000	72,000	24,000	0,340	2	SNR
7910CDBT/GMP4	50,000	72,000	36,000	0,390	2	NTN
7910T1DBT/G035P4	50,000	72,000	36,000	0,390	2	NTN
2LA-BNS911ADLLBG/GNP42	55,000	80,000	13,000	0,190	2	NTN
2LA-BNS911CLLLBG/GNP42	55,000	80,000	13,000	0,190	2	NTN
2LA-BNS911LLBG/GNP42	55,000	80,000	13,000	0,190	2	NTN
2LA-HSE911ADG/GNP42	55,000	80,000	13,000	0,190	2	NTN
2LA-HSE911CG/GNP42	55,000	80,000	13,000	0,190	2	NTN
2LA-HSE911G/GNP42	55,000	80,000	13,000	0,190	2	NTN
5S-2LA-BNS911ADLLBG/GNP42	55,000	80,000	13,000	0,180	2	NTN
5S-2LA-BNS911CLLLBG/GNP42	55,000	80,000	13,000	0,180	2	NTN
5S-2LA-BNS911LLBG/GNP42	55,000	80,000	13,000	0,180	2	NTN
5S-2LA-HSE911ADG/GNP42	55,000	80,000	13,000	0,180	2	NTN
5S-2LA-HSE911CG/GNP42	55,000	80,000	13,000	0,180	2	NTN
5S-2LA-HSE911G/GNP42	55,000	80,000	13,000	0,180	2	NTN
5S-7911UADG/GNP42	55,000	80,000	13,000	0,160	2	NTN
5S-7911UCG/GNP42	55,000	80,000	13,000	0,160	2	NTN

Reference	d	D	B	Kg		Brands
7911UADG/GNP42	55,000	80,000	13,000	0,180	2	NTN
7911UCG/GLP4	55,000	80,000	13,000	0,180	2	NTN
7911UCG/GNP4	55,000	80,000	13,000	0,180	2	NTN
7911UCG/GNP42	55,000	80,000	13,000	0,180	2	NTN
7911UCP4	55,000	80,000	13,000	0,180	2	NTN
HSB911CP4	55,000	80,000	13,000	0,187	2	NTN
71911CVUJ74	55,000	80,000	13,000	0,200	2	SNR
71911HVUJ74	55,000	80,000	13,000	0,196	2	SNR
ML71911CVDUJ74S	55,000	80,000	13,000	0,876	2	SNR
ML71911CVUJ74S	55,000	80,000	13,000	0,204	2	SNR
ML71911HVDUJ74S	55,000	80,000	13,000	0,354	2	SNR
ML71911HVUJ74S	55,000	80,000	13,000	0,192	2	SNR
MLE71911CVUJ74S	55,000	80,000	13,000	0,204	2	SNR
MLE71911HVUJ74S	55,000	80,000	13,000	0,190	2	SNR
7911T1DF/GNP4	55,000	80,000	26,000	0,360	2	NTN
7911UCDB/GLP4	55,000	80,000	26,000	0,360	2	NTN
71911CVDUJ74	55,000	80,000	26,000	0,372	2	SNR
71911HVDUJ74	55,000	80,000	26,000	0,386	2	SNR
MLE71911CVDUJ74S	55,000	80,000	26,000	0,398	2	SNR
MLE71911HVDUJ74S	55,000	80,000	26,000	0,396	2	SNR
2LA-BNS912ADLLBG/GNP42	60,000	85,000	13,000	0,210	2	NTN
2LA-BNS912CLLBG/GNP42	60,000	85,000	13,000	0,210	2	NTN
2LA-BNS912LLBG/GNP42	60,000	85,000	13,000	0,210	2	NTN
2LA-HSE912ADG/GNP42	60,000	85,000	13,000	0,210	2	NTN
2LA-HSE912CG/GNP42	60,000	85,000	13,000	0,210	2	NTN
2LA-HSE912G/GNP42	60,000	85,000	13,000	0,210	2	NTN
5S-2LA-BNS912ADLLBG/GNP42	60,000	85,000	13,000	0,200	2	NTN
5S-2LA-BNS912CLLBG/GNP42	60,000	85,000	13,000	0,200	2	NTN
5S-2LA-BNS912LLBG/GNP42	60,000	85,000	13,000	0,200	2	NTN
5S-2LA-HSE912ADG/GNP42	60,000	85,000	13,000	0,190	2	NTN
5S-2LA-HSE912CG/GNP42	60,000	85,000	13,000	0,190	2	NTN
5S-2LA-HSE912G/GNP42	60,000	85,000	13,000	0,190	2	NTN
5S-7912UADG/GNP42	60,000	85,000	13,000	0,160	2	NTN
5S-7912UCG/GNP42	60,000	85,000	13,000	0,160	2	NTN
7912UADG/GLUP-5	60,000	85,000	13,000	0,190	2	NTN
7912UADG/GNP42	60,000	85,000	13,000	0,190	2	NTN
7912UCG/GNP4	60,000	85,000	13,000	0,190	2	NTN
7912UCG/GNP42	60,000	85,000	13,000	0,190	2	NTN
7912UG/GNP42	60,000	85,000	13,000	0,190	2	NTN
71912CVUJ74	60,000	85,000	13,000	0,214	2	SNR
71912HVUJ74	60,000	85,000	13,000	0,210	2	SNR
ML71912CVDUJ74S	60,000	85,000	13,000	0,380	2	SNR
ML71912CVUJ74S	60,000	85,000	13,000	0,210	2	SNR
ML71912HVDUJ74S	60,000	85,000	13,000	0,380	2	SNR
ML71912HVUJ74S	60,000	85,000	13,000	0,206	2	SNR
MLE71912CVUJ74S	60,000	85,000	13,000	0,220	2	SNR
MLE71912HVUJ74S	60,000	85,000	13,000	0,218	2	SNR

Reference	d	D	B	Kg		Brands
7912CDB/GLP5	60,000	85,000	26,000	0,380	2	NTN
7912UCDB/GNP5	60,000	85,000	26,000	0,380	2	NTN
71912CVDUJ74	60,000	85,000	26,000	0,427	2	SNR
71912HVDUJ74	60,000	85,000	26,000	0,425	2	SNR
MLE71912CVDUJ74S	60,000	85,000	26,000	0,380	2	SNR
MLE71912HVDUJ74S	60,000	85,000	26,000	0,380	2	SNR
2LA-BNS913ADLLBG/GNP42	65,000	90,000	13,000	0,220	2	NTN
2LA-BNS913CLLBG/GNP42	65,000	90,000	13,000	0,220	2	NTN
2LA-BNS913LLBG/GNP42	65,000	90,000	13,000	0,220	2	NTN
2LA-HSE913ADG/GNP42	65,000	90,000	13,000	0,220	2	NTN
2LA-HSE913CG/GNP42	65,000	90,000	13,000	0,220	2	NTN
2LA-HSE913G/GNP42	65,000	90,000	13,000	0,220	2	NTN
5S-2LA-BNS913ADLLBG/GNP42	65,000	90,000	13,000	0,210	2	NTN
5S-2LA-BNS913CLLBG/GNP42	65,000	90,000	13,000	0,210	2	NTN
5S-2LA-BNS913LLBG/GNP42	65,000	90,000	13,000	0,210	2	NTN
5S-2LA-HSE913ADG/GNP42	65,000	90,000	13,000	0,210	2	NTN
5S-2LA-HSE913CG/GNP42	65,000	90,000	13,000	0,210	2	NTN
5S-2LA-HSE913G/GNP42	65,000	90,000	13,000	0,210	2	NTN
5S-7913UADG/GNP42	65,000	90,000	13,000	0,190	2	NTN
5S-7913UCG/GNP42	65,000	90,000	13,000	0,190	2	NTN
7913CG/GLP4	65,000	90,000	13,000	0,210	2	NTN
7913UADG/GNP42	65,000	90,000	13,000	0,210	2	NTN
7913UCG/GNP4	65,000	90,000	13,000	0,210	2	NTN
7913UCG/GNP42	65,000	90,000	13,000	0,210	2	NTN
71913CVUJ74	65,000	90,000	13,000	0,223	2	SNR
71913HVUJ74	65,000	90,000	13,000	0,272	2	SNR
ML71913CVDUJ74S	65,000	90,000	13,000	0,404	2	SNR
ML71913CVUJ74S	65,000	90,000	13,000	0,228	2	SNR
ML71913HVDUJ74S	65,000	90,000	13,000	0,404	2	SNR
ML71913HVUJ74S	65,000	90,000	13,000	0,228	2	SNR
MLE71913CVUJ74S	65,000	90,000	13,000	0,202	2	SNR
MLE71913HVUJ74S	65,000	90,000	13,000	0,202	2	SNR
71913CVDUJ74	65,000	90,000	26,000	0,455	2	SNR
71913HVDUJ74	65,000	90,000	26,000	0,456	2	SNR
71913HVQUJ74	65,000	90,000	52,000	0,913	2	SNR
2LA-BNS914ADLLBG/GNP42	70,000	100,000	16,000	0,380	2	NTN
2LA-BNS914CLLBG/GNP42	70,000	100,000	16,000	0,380	2	NTN
2LA-BNS914LLBG/GNP42	70,000	100,000	16,000	0,380	2	NTN
2LA-HSE914ADG/GNP42	70,000	100,000	16,000	0,360	2	NTN
2LA-HSE914CG/GNP42	70,000	100,000	16,000	0,360	2	NTN
2LA-HSE914G/GNP42	70,000	100,000	16,000	0,360	2	NTN
5S-2LA-BNS914ADLLBG/GNP42	70,000	100,000	16,000	0,360	2	NTN
5S-2LA-BNS914CLLBG/GNP42	70,000	100,000	16,000	0,360	2	NTN
5S-2LA-BNS914LLBG/GNP42	70,000	100,000	16,000	0,360	2	NTN
5S-2LA-HSE914ADG/GNP42	70,000	100,000	16,000	0,340	2	NTN
5S-2LA-HSE914CG/GNP42	70,000	100,000	16,000	0,340	2	NTN
5S-2LA-HSE914G/GNP42	70,000	100,000	16,000	0,340	2	NTN
5S-7914UADG/GNP42	70,000	100,000	16,000	0,300	2	NTN
5S-7914UCG/GNP42	70,000	100,000	16,000	0,300	2	NTN

Reference	d	D	B	Kg		Brands
7914UADG/GNP42	70,000	100,000	16,000	0,340	2	NTN
7914UCG/GLP4	70,000	100,000	16,000	0,340	2	NTN
7914UCG/GNP4	70,000	100,000	16,000	0,340	2	NTN
7914UCG/GNP42	70,000	100,000	16,000	0,340	2	NTN
71914CVUJ74	70,000	100,000	16,000	0,444	2	SNR
71914HVUJ74	70,000	100,000	16,000	0,358	2	SNR
ML71914CVDUJ74S	70,000	100,000	16,000	0,660	2	SNR
ML71914CVUJ74S	70,000	100,000	16,000	0,344	2	SNR
ML71914HVDUJ74S	70,000	100,000	16,000	0,660	2	SNR
ML71914HVUJ74S	70,000	100,000	16,000	0,344	2	SNR
MLE71914CVUJ74S	70,000	100,000	16,000	0,330	2	SNR
MLE71914HVDUJ74S	70,000	100,000	16,000	0,660	2	SNR
MLE71914HVUJ74S	70,000	100,000	16,000	0,370	2	SNR
71914CVDUJ74	70,000	100,000	32,000	0,722	2	SNR
71914HVDUJ74	70,000	100,000	32,000	0,718	2	SNR
2LA-BNS915ADLLBG/GNP42	75,000	105,000	16,000	0,390	2	NTN
2LA-BNS915CLLBBG/GNP42	75,000	105,000	16,000	0,390	2	NTN
2LA-BNS915LLBBG/GNP42	75,000	105,000	16,000	0,390	2	NTN
2LA-HSE915ADG/GNP42	75,000	105,000	16,000	0,380	2	NTN
2LA-HSE915CG/GNP42	75,000	105,000	16,000	0,380	2	NTN
2LA-HSE915G/GNP42	75,000	105,000	16,000	0,380	2	NTN
5S-2LA-BNS915ADLLBG/GNP42	75,000	105,000	16,000	0,370	2	NTN
5S-2LA-BNS915CLLBBG/GNP42	75,000	105,000	16,000	0,370	2	NTN
5S-2LA-BNS915LLBBG/GNP42	75,000	105,000	16,000	0,370	2	NTN
5S-2LA-HSE915ADG/GNP42	75,000	105,000	16,000	0,360	2	NTN
5S-2LA-HSE915CG/GNP42	75,000	105,000	16,000	0,360	2	NTN
5S-2LA-HSE915G/GNP42	75,000	105,000	16,000	0,360	2	NTN
5S-7915UADG/GNP42	75,000	105,000	16,000	0,320	2	NTN
5S-7915UCG/GNP42	75,000	105,000	16,000	0,320	2	NTN
7915UADG/GNP42	75,000	105,000	16,000	0,360	2	NTN
7915UCG/GNP42	75,000	105,000	16,000	0,360	2	NTN
7915UCGD2/GNP4	75,000	105,000	16,000	0,360	2	NTN
71915CVUJ74	75,000	105,000	16,000	0,382	2	SNR
71915HVUJ74	75,000	105,000	16,000	0,383	2	SNR
ML71915CVDUJ74S	75,000	105,000	16,000	0,698	2	SNR
ML71915CVUJ74S	75,000	105,000	16,000	0,398	2	SNR
ML71915HVDUJ74S	75,000	105,000	16,000	0,698	2	SNR
ML71915HVUJ74S	75,000	105,000	16,000	0,400	2	SNR
71915CVDUJ74	75,000	105,000	32,000	0,767	2	SNR
71915HVDUJ74	75,000	105,000	32,000	0,772	2	SNR
2LA-BNS916ADLLBG/GNP42	80,000	110,000	16,000	0,410	2	NTN
2LA-BNS916CLLBBG/GNP42	80,000	110,000	16,000	0,410	2	NTN
2LA-BNS916LLBBG/GNP42	80,000	110,000	16,000	0,410	2	NTN
2LA-HSE916ADG/GNP42	80,000	110,000	16,000	0,400	2	NTN
2LA-HSE916CG/GNP42	80,000	110,000	16,000	0,400	2	NTN
2LA-HSE916G/GNP42	80,000	110,000	16,000	0,400	2	NTN
5S-2LA-BNS916ADLLBG/GNP42	80,000	110,000	16,000	0,390	2	NTN
5S-2LA-BNS916CLLBBG/GNP42	80,000	110,000	16,000	0,390	2	NTN

Reference	d	D	B	Kg		Brands
5S-2LA-BNS916LLBG/GNP42	80,000	110,000	16,000	0,390	2	NTN
5S-2LA-HSE916ADG/GNP42	80,000	110,000	16,000	0,380	2	NTN
5S-2LA-HSE916CG/GNP42	80,000	110,000	16,000	0,380	2	NTN
5S-2LA-HSE916G/GNP42	80,000	110,000	16,000	0,380	2	NTN
5S-7916UADG/GNP42	80,000	110,000	16,000	0,330	2	NTN
5S-7916UCG/GNP42	80,000	110,000	16,000	0,330	2	NTN
7916CG/GLP4	80,000	110,000	16,000	0,380	2	NTN
7916CG/GNP4	80,000	110,000	16,000	0,380	2	NTN
7916CG/GNUP	80,000	110,000	16,000	0,380	2	NTN
7916T1G/GNUP-3	80,000	110,000	16,000	0,380	2	NTN
7916UADG/GNP42	80,000	110,000	16,000	0,380	2	NTN
7916UCG/GNP4	80,000	110,000	16,000	0,380	2	NTN
7916UCG/GNP42	80,000	110,000	16,000	0,380	2	NTN
71916CVUJ74	80,000	110,000	16,000	0,402	2	SNR
71916HVUJ74	80,000	110,000	16,000	0,402	2	SNR
ML71916CVDUJ74S	80,000	110,000	16,000	0,740	2	SNR
ML71916CVUJ74S	80,000	110,000	16,000	0,394	2	SNR
ML71916HVDUJ74S	80,000	110,000	16,000	0,740	2	SNR
ML71916HVUJ74S	80,000	110,000	16,000	0,398	2	SNR
71916CVDUJ74	80,000	110,000	32,000	0,811	2	SNR
71916HVDUJ74	80,000	110,000	32,000	0,810	2	SNR
2LA-BNS917ADLLBG/GNP42	85,000	120,000	18,000	0,590	2	NTN
2LA-BNS917CLLBBG/GNP42	85,000	120,000	18,000	0,590	2	NTN
2LA-BNS917LLBBG/GNP42	85,000	120,000	18,000	0,590	2	NTN
2LA-HSE917ADG/GNP42	85,000	120,000	18,000	0,580	2	NTN
2LA-HSE917CG/GNP42	85,000	120,000	18,000	0,580	2	NTN
2LA-HSE917G/GNP42	85,000	120,000	18,000	0,580	2	NTN
5S-2LA-BNS917ADLLBG/GNP42	85,000	120,000	18,000	0,570	2	NTN
5S-2LA-BNS917CLLBBG/GNP42	85,000	120,000	18,000	0,570	2	NTN
5S-2LA-BNS917LLBBG/GNP42	85,000	120,000	18,000	0,570	2	NTN
5S-2LA-HSE917ADG/GNP42	85,000	120,000	18,000	0,550	2	NTN
5S-2LA-HSE917CG/GNP42	85,000	120,000	18,000	0,550	2	NTN
5S-2LA-HSE917G/GNP42	85,000	120,000	18,000	0,550	2	NTN
5S-7917UADG/GNP42	85,000	120,000	18,000	0,470	2	NTN
5S-7917UCG/GNP42	85,000	120,000	18,000	0,470	2	NTN
7917UADG/GNP42	85,000	120,000	18,000	0,540	2	NTN
7917UCG/GNP4	85,000	120,000	18,000	0,540	2	NTN
7917UCG/GNP42	85,000	120,000	18,000	0,540	2	NTN
71917CVUJ74	85,000	120,000	18,000	0,581	2	SNR
71917HVUJ74	85,000	120,000	18,000	0,574	2	SNR
ML71917CVDUJ74S	85,000	120,000	18,000	0,535	2	SNR
ML71917CVUJ74S	85,000	120,000	18,000	0,535	2	SNR
ML71917HVDUJ74S	85,000	120,000	18,000	0,535	2	SNR
ML71917HVUJ74S	85,000	120,000	18,000	0,535	2	SNR
71917CVDUJ74	85,000	120,000	36,000	1,150	2	SNR
71917HVDUJ74	85,000	120,000	36,000	1,150	2	SNR
2LA-BNS918ADLLBG/GNP42	90,000	125,000	18,000	0,620	2	NTN
2LA-BNS918CLLBBG/GNP42	90,000	125,000	18,000	0,620	2	NTN
2LA-BNS918LLBBG/GNP42	90,000	125,000	18,000	0,620	2	NTN

Reference	d	D	B	Kg	?	Brands
2LA-HSE918ADG/GNP42	90,000	125,000	18,000	0,610	2	NTN
2LA-HSE918CG/GNP42	90,000	125,000	18,000	0,610	2	NTN
2LA-HSE918G/GNP42	90,000	125,000	18,000	0,610	2	NTN
5S-2LA-BNS918ADLLBG/GNP42	90,000	125,000	18,000	0,590	2	NTN
5S-2LA-BNS918CLLLBG/GNP42	90,000	125,000	18,000	0,590	2	NTN
5S-2LA-BNS918LLBG/GNP42	90,000	125,000	18,000	0,590	2	NTN
5S-2LA-HSE918ADG/GNP42	90,000	125,000	18,000	0,580	2	NTN
5S-2LA-HSE918CG/GNP42	90,000	125,000	18,000	0,580	2	NTN
5S-2LA-HSE918G/GNP42	90,000	125,000	18,000	0,580	2	NTN
5S-7918UADG/GNP42	90,000	125,000	18,000	0,490	2	NTN
5S-7918UCG/GNP42	90,000	125,000	18,000	0,490	2	NTN
7918CG/GNP4	90,000	125,000	18,000	0,560	2	NTN
7918UADG/GNP42	90,000	125,000	18,000	0,560	2	NTN
7918UCG/GNP4	90,000	125,000	18,000	0,560	2	NTN
7918UCG/GNP42	90,000	125,000	18,000	0,560	2	NTN
7918UG/GMP42	90,000	125,000	18,000	0,560	2	NTN
71918CVUJ74	90,000	125,000	18,000	0,610	2	SNR
71918HVUJ74	90,000	125,000	18,000	0,606	2	SNR
ML71918CVDUJ74S	90,000	125,000	18,000	1,124	2	SNR
ML71918CVUJ74S	90,000	125,000	18,000	0,590	2	SNR
ML71918HVDUJ74S	90,000	125,000	18,000	1,124	2	SNR
ML71918HVUJ74S	90,000	125,000	18,000	0,592	2	SNR
71918CVDUJ74	90,000	125,000	36,000	1,218	2	SNR
71918HVDUJ74	90,000	125,000	36,000	1,212	2	SNR
2LA-BNS919ADLLBG/GNP42	95,000	130,000	18,000	0,650	2	NTN
2LA-BNS919CLLLBG/GNP42	95,000	130,000	18,000	0,650	2	NTN
2LA-BNS919LLBG/GNP42	95,000	130,000	18,000	0,650	2	NTN
2LA-HSE919ADG/GNP42	95,000	130,000	18,000	0,640	2	NTN
2LA-HSE919CG/GNP42	95,000	130,000	18,000	0,640	2	NTN
2LA-HSE919G/GNP42	95,000	130,000	18,000	0,640	2	NTN
5S-2LA-BNS919ADLLBG/GNP42	95,000	130,000	18,000	0,620	2	NTN
5S-2LA-BNS919CLLLBG/GNP42	95,000	130,000	18,000	0,620	2	NTN
5S-2LA-BNS919LLBG/GNP42	95,000	130,000	18,000	0,620	2	NTN
5S-2LA-HSE919ADG/GNP42	95,000	130,000	18,000	0,600	2	NTN
5S-2LA-HSE919CG/GNP42	95,000	130,000	18,000	0,600	2	NTN
5S-2LA-HSE919G/GNP42	95,000	130,000	18,000	0,600	2	NTN
7919UCG/GNP4	95,000	130,000	18,000	0,590	2	NTN
71919CVUJ74	95,000	130,000	18,000	0,650	2	SNR
71919HVUJ74	95,000	130,000	18,000	0,620	2	SNR
7919CDB/GMP5	95,000	130,000	36,000	1,180	2	NTN
71919CVDUJ74	95,000	130,000	36,000	0,157	2	SNR
71919HVDUJ74	95,000	130,000	36,000	1,308	2	SNR
7919DTBT/GMP4	95,000	130,000	72,000	2,360	2	NTN
2LA-BNS920ADLLBG/GNP42	100,000	140,000	20,000	0,870	2	NTN
2LA-BNS920CLLLBG/GNP42	100,000	140,000	20,000	0,870	2	NTN
2LA-BNS920LLBG/GNP42	100,000	140,000	20,000	0,870	2	NTN
2LA-HSE920ADG/GNP42	100,000	140,000	20,000	0,860	2	NTN
2LA-HSE920CG/GNP42	100,000	140,000	20,000	0,860	2	NTN
2LA-HSE920G/GNP42	100,000	140,000	20,000	0,860	2	NTN
5S-2LA-BNS920ADLLBG/GNP42	100,000	140,000	20,000	0,820	2	NTN
5S-2LA-BNS920CLLLBG/GNP42	100,000	140,000	20,000	0,820	2	NTN

Reference	d	D	B	Kg	?	Brands
5S-2LA-BNS920LLBG/GNP42	100,000	140,000	20,000	0,200	2	NTN
5S-2LA-HSE920ADG/GNP42	100,000	140,000	20,000	0,810	2	NTN
5S-2LA-HSE920CG/GNP42	100,000	140,000	20,000	0,810	2	NTN
5S-2LA-HSE920G/GNP42	100,000	140,000	20,000	0,810	2	NTN
5S-7920UADG/GNP42	100,000	140,000	20,000	0,520	2	NTN
5S-7920UCG/GNP42	100,000	140,000	20,000	0,520	2	NTN
7920UADG/GNP42	100,000	140,000	20,000	0,810	2	NTN
7920UCG/GNP4	100,000	140,000	20,000	0,810	2	NTN
7920UCG/GNP42	100,000	140,000	20,000	0,810	2	NTN
71920CVUJ74	100,000	140,000	20,000	0,930	2	SNR
71920HVUJ74	100,000	140,000	20,000	0,920	2	SNR
ML71920CVDUJ74S	100,000	140,000	20,000	1,592	2	SNR
ML71920CVUJ74S	100,000	140,000	20,000	0,905	2	SNR
ML71920HVDUJ74S	100,000	140,000	20,000	1,592	2	SNR
ML71920HVUJ74S	100,000	140,000	20,000	0,896	2	SNR
71920CVDUJ74	100,000	140,000	40,000	1,763	2	SNR
71920HVDUJ74	100,000	140,000	40,000	1,880	2	SNR
2LA-HSE921ADG/GNP42	105,000	145,000	20,000	0,890	2	NTN
2LA-HSE921CG/GNP42	105,000	145,000	20,000	0,890	2	NTN
2LA-HSE921G/GNP42	105,000	145,000	20,000	0,890	2	NTN
5S-2LA-HSE921ADG/GNP42	105,000	145,000	20,000	0,840	2	NTN
5S-2LA-HSE921CG/GNP42	105,000	145,000	20,000	0,840	2	NTN
5S-2LA-HSE921G/GNP42	105,000	145,000	20,000	0,840	2	NTN
5S-7921UADG/GNP42	105,000	145,000	20,000	0,730	2	NTN
5S-7921UCG/GNP42	105,000	145,000	20,000	0,730	2	NTN
7921UADG/GNP42	105,000	145,000	20,000	0,840	2	NTN
7921UCG/GNP42	105,000	145,000	20,000	0,840	2	NTN
7921CDB/GLP4	105,000	145,000	40,000	1,680	2	NTN
2LA-HSE922ADG/GNP42	110,000	150,000	20,000	0,930	2	NTN
2LA-HSE922CG/GNP42	110,000	150,000	20,000	0,930	2	NTN
2LA-HSE922G/GNP42	110,000	150,000	20,000	0,930	2	NTN
5S-2LA-HSE922ADG/GNP42	110,000	150,000	20,000	0,870	2	NTN
5S-2LA-HSE922CG/GNP42	110,000	150,000	20,000	0,870	2	NTN
5S-2LA-HSE922G/GNP42	110,000	150,000	20,000	0,870	2	NTN
5S-7922UADG/GNP42	110,000	150,000	20,000	0,760	2	NTN
5S-7922UCG/GNP42	110,000	150,000	20,000	0,760	2	NTN
7922UADG/GNP42	110,000	150,000	20,000	0,870	2	NTN
7922UCG/GNP42	110,000	150,000	20,000	0,870	2	NTN
71922CVUJ74	110,000	150,000	20,000	0,928	2	SNR
71922HVUJ74	110,000	150,000	20,000	0,927	2	SNR
ML71922CVUJ74S	110,000	150,000	20,000	0,868	2	SNR
ML71922HVUJ74S	110,000	150,000	20,000	0,868	2	SNR
71922CVDUJ74	110,000	150,000	40,000	1,847	2	SNR
71922HVDUJ74	110,000	150,000	40,000	1,851	2	SNR
2LA-BNS924ADLLBG/GNP42/L749	120,000	165,000	22,000	1,300	2	NTN
2LA-HSE924ADG/GNP42	120,000	165,000	22,000	1,270	2	NTN
2LA-HSE924CG/GNP42	120,000	165,000	22,000	1,270	2	NTN

Reference	d	D	B	Kg		Brands
2LA-HSE924G/GNP42	120,000	165,000	22,000	1,270	2	NTN
5S-2LA-HSE924ADG/GNP42	120,000	165,000	22,000	1,200	2	NTN
5S-2LA-HSE924CG/GNP42	120,000	165,000	22,000	1,200	2	NTN
5S-2LA-HSE924G/GNP42	120,000	165,000	22,000	1,200	2	NTN
5S-7924UADG/GNP42	120,000	165,000	22,000	1,030	2	NTN
5S-7924UCG/GNP42	120,000	165,000	22,000	1,030	2	NTN
7924CG/GNP4	120,000	165,000	22,000	1,190	2	NTN
7924UADG/GNP42	120,000	165,000	22,000	1,190	2	NTN
7924UCG/GNP42	120,000	165,000	22,000	1,190	2	NTN
71924CVUJ74	120,000	165,000	22,000	1,260	2	SNR
71924HVUJ74	120,000	165,000	22,000	1,239	2	SNR
HTA924DB/GNP4L	120,000	165,000	40,500	2,460	2	NTN
7924CDB/GHUP-4	120,000	165,000	44,000	2,380	2	NTN
7924UCDB/GHUP-4	120,000	165,000	44,000	2,380	2	NTN
71924CVDUJ74	120,000	165,000	44,000	2,550	2	SNR
71924HVDUJ74	120,000	165,000	44,000	2,606	2	SNR
HTA924DBT/GMP4L	120,000	165,000	60,750	2,460	2	NTN
HTA924UDBT/GMP4L	120,000	165,000	60,750	2,460	2	NTN
2LA-BNS926ADLLBG/GLP42/L749	130,000	180,000	24,000	1,737	2	NTN
2LA-HSE926ADG/GNP42	130,000	180,000	24,000	1,690	2	NTN
2LA-HSE926CG/GNP42	130,000	180,000	24,000	1,690	2	NTN
2LA-HSE926G/GNP42	130,000	180,000	24,000	1,690	2	NTN
5S-2LA-HSE926ADG/GNP42	130,000	180,000	24,000	1,590	2	NTN
5S-2LA-HSE926CG/GNP42	130,000	180,000	24,000	1,590	2	NTN
5S-2LA-HSE926G/GNP42	130,000	180,000	24,000	1,590	2	NTN
5S-7926UADG/GNP42	130,000	180,000	24,000	1,340	2	NTN
5S-7926UCG/GNP42	130,000	180,000	24,000	1,340	2	NTN
7926CT1G/GMUP	130,000	180,000	24,000	1,570	2	NTN
7926UADG/GNP42	130,000	180,000	24,000	1,570	2	NTN
7926UCG/GNP42	130,000	180,000	24,000	1,570	2	NTN
71926CVUJ74	130,000	180,000	24,000	1,720	2	SNR
71926HVUJ74	130,000	180,000	24,000	1,624	2	SNR
7926UDB/GNP5	130,000	180,000	48,000	3,140	2	NTN
71926CVDUJ74	130,000	180,000	48,000	3,224	2	SNR
71926HVDUJ74	130,000	180,000	48,000	3,228	2	SNR
2LA-HSE928ADG/GNP42	140,000	190,000	24,000	1,800	2	NTN
2LA-HSE928CG/GNP42	140,000	190,000	24,000	1,800	2	NTN
2LA-HSE928G/GNP42	140,000	190,000	24,000	1,800	2	NTN
5S-2LA-HSE928ADG/GNP42	140,000	190,000	24,000	1,700	2	NTN
5S-2LA-HSE928CG/GNP42	140,000	190,000	24,000	1,700	2	NTN
5S-2LA-HSE928G/GNP42	140,000	190,000	24,000	1,700	2	NTN
5S-7928CT1B/GNP42	140,000	190,000	24,000	1,660	2	NTN
7928CT1B/GNP42	140,000	190,000	24,000	1,660	2	NTN
71928CVUJ74	140,000	190,000	24,000	1,724	2	SNR
71928HVUJ74	140,000	190,000	24,000	1,752	2	SNR
71928CVDUJ74	140,000	190,000	48,000	3,448	2	SNR
71928HVDUJ74	140,000	190,000	48,000	3,476	2	SNR

Reference	d	D	B	Kg		Brands
2LA-HSE930ADG/GNP42	150,000	210,000	28,000	2,740	2	NTN
2LA-HSE930CG/GNP42	150,000	210,000	28,000	2,740	2	NTN
2LA-HSE930G/GNP42	150,000	210,000	28,000	2,740	2	NTN
5S-2LA-HSE930ADG/GNP42	150,000	210,000	28,000	2,570	2	NTN
5S-2LA-HSE930CG/GNP42	150,000	210,000	28,000	2,570	2	NTN
5S-2LA-HSE930G/GNP42	150,000	210,000	28,000	2,570	2	NTN
5S-7930CT1B/GNP42	150,000	210,000	28,000	2,220	2	NTN
7930CP5	150,000	210,000	28,000	2,843	2	NTN
7930CT1B/GNP42	150,000	210,000	28,000	2,590	2	NTN
7930CT1BG/GLP4	150,000	210,000	28,000	2,700	2	NTN
71930CVUJ74	150,000	210,000	28,000	2,666	2	SNR
71930HVUJ74	150,000	210,000	28,000	2,820	2	SNR
7930CDB/GMP5	150,000	210,000	56,000	5,920	2	NTN
7930CDB/GNP5	150,000	210,000	56,000	5,920	2	NTN
7930DB/GNP5	150,000	210,000	56,000	5,689	2	NTN
71930CVDUJ74	150,000	210,000	56,000	5,332	2	SNR
71930HVDUJ74	150,000	210,000	56,000	5,324	2	SNR
7930CDB+50/GNP5	150,000	210,000	106,000	8,909	2	NTN
2LA-BNS932ADLLBG/GLP42/L749	160,000	220,000	28,000	2,957	2	NTN
2LA-HSE932ADG/GNP42	160,000	220,000	28,000	2,890	2	NTN
2LA-HSE932CG/GNP42	160,000	220,000	28,000	2,890	2	NTN
2LA-HSE932G/GNP42	160,000	220,000	28,000	2,890	2	NTN
5S-2LA-HSE932ADG/GNP42	160,000	220,000	28,000	2,710	2	NTN
5S-2LA-HSE932CG/GNP42	160,000	220,000	28,000	2,710	2	NTN
5S-2LA-HSE932G/GNP42	160,000	220,000	28,000	2,710	2	NTN
5S-7932CT1B/GNP42	160,000	220,000	28,000	2,220	2	NTN
7932CT1B/GNP42	160,000	220,000	28,000	2,720	2	NTN
7932CT1BG/GLP4	160,000	220,000	28,000	2,800	2	NTN
71932CVUJ74	160,000	220,000	28,000	2,980	2	SNR
71932HVUJ74	160,000	220,000	28,000	2,803	2	SNR
HTA932ADB/GNP4L	160,000	220,000	54,000	5,780	2	NTN
HTA932DB/G20P4L	160,000	220,000	54,000	5,700	2	NTN
HTA932DB/GNP4L	160,000	220,000	54,000	5,780	2	NTN
71932CVDUJ74	160,000	220,000	56,000	5,624	2	SNR
71932HVDUJ74	160,000	220,000	56,000	5,640	2	SNR
2LA-HSE934ADG/GNP42	170,000	230,000	28,000	3,040	2	NTN
2LA-HSE934CG/GNP42	170,000	230,000	28,000	3,040	2	NTN
2LA-HSE934G/GNP42	170,000	230,000	28,000	3,040	2	NTN
5S-2LA-HSE934ADG/GNP42	170,000	230,000	28,000	2,850	2	NTN
5S-2LA-HSE934CG/GNP42	170,000	230,000	28,000	2,850	2	NTN
5S-2LA-HSE934G/GNP42	170,000	230,000	28,000	2,850	2	NTN
5S-7934CT1B/GNP42	170,000	230,000	28,000	2,890	2	NTN
7934CT1B/GNP42	170,000	230,000	28,000	2,890	2	NTN
71934CVUJ74	170,000	230,000	28,000	2,998	2	SNR
71934HVUJ74	170,000	230,000	28,000	3,060	2	SNR
7934CDB/GNP4	170,000	230,000	56,000	6,494	2	NTN

Reference	d	D	B	Kg		Brands
71934CVDUJ74	170,000	230,000	56,000	6,020	2	SNR
71934HVDUJ74	170,000	230,000	56,000	6,100	2	SNR
71936CVUJ74	180,000	250,000	33,000	4,396	2	SNR
71936HVUJ74	180,000	250,000	33,000	4,356	2	SNR
HTA936ADB/G25P4L	180,000	250,000	63,000	9,560	2	NTN
71936CVDUJ74	180,000	250,000	66,000	8,678	2	SNR
71936HVDUJ74	180,000	250,000	66,000	8,944	2	SNR
HTA936DB+20D2/GNP4L	180,000	250,000	83,000	12,199	2	NTN
HTA936T1DB+20D2/GNP4L	180,000	250,000	83,000	12,900	2	NTN
7936CDB+40/GNP5	180,000	250,000	106,000	13,000	2	NTN
71938CVUJ74	190,000	260,000	33,000	4,920	2	SNR
71938HVUJ74	190,000	260,000	33,000	4,650	2	SNR
7938L1BDB/GLP4L	190,000	260,000	66,000	10,200	2	NTN
71938CVDUJ74	190,000	260,000	66,000	9,710	2	SNR
71938HVDUJ74	190,000	260,000	66,000	9,792	2	SNR
71940CVUJ74	200,000	280,000	38,000	6,270	2	SNR
71940HVUJ74	200,000	280,000	38,000	6,241	2	SNR
71940CVDUJ74	200,000	280,000	76,000	12,504	2	SNR
71940HVDUJ74	200,000	280,000	76,000	11,000	2	SNR
71944CVUJ74	220,000	300,000	38,000	6,930	2	SNR
71944HVUJ74	220,000	300,000	38,000	6,988	2	SNR
HTA944DB/GNP4L	220,000	300,000	72,000	7,600	2	NTN
71944CVDUJ74	220,000	300,000	76,000	16,000	2	SNR
71944HVDUJ74	220,000	300,000	76,000	16,000	2	SNR
71948CVUJ74	240,000	320,000	38,000	7,394	2	SNR
71948HVUJ74	240,000	320,000	38,000	7,382	2	SNR
71948CVDUJ74	240,000	320,000	76,000	20,000	2	SNR
71948HVDUJ74	240,000	320,000	76,000	14,766	2	SNR
7952DB/GNP5	260,000	360,000	92,000	28,000	2	NTN
7952DFP5	260,000	360,000	92,000	28,000	2	NTN
HTA964DB/GNP4L	320,000	440,000	108,000	48,500	2	NTN
7968L1BDB/GNP5	340,000	460,000	112,000	51,272	2	NTN
562006/GNP4	30,000	55,000	32,000	0,301	35	NTN
562007/GNP5	35,000	62,000	34,000	0,394	35	NTN
562008/GNP5	40,000	68,000	36,000	0,482	35	NTN
562009/GNP4	45,000	75,000	38,000	0,605	35	NTN
562010/GNP5	50,000	80,000	38,000	0,638	35	NTN
562011/GNP5	55,000	90,000	44,000	0,988	35	NTN
562012/GNP5	60,000	95,000	44,000	1,060	35	NTN
562013/GNP5	65,000	100,000	44,000	1,080	35	NTN
562014/GNP5	70,000	110,000	48,000	1,530	35	NTN
562015/GNP4	75,000	115,000	48,000	1,610	35	NTN
562016/GNP4	80,000	125,000	54,000	2,200	35	NTN
562016M/GNP4	83,000	125,000	54,000	2,000	35	NTN
562017/GNP5	85,000	130,000	54,000	2,310	35	NTN
562018/GNP4	90,000	140,000	60,000	3,050	35	NTN
562018M/GNP5	93,000	140,000	60,000	2,700	35	NTN
562019/GNP5	95,000	145,000	60,000	3,180	35	NTN
562020/GLP4	100,000	150,000	60,000	3,320	35	NTN
562922/GNP5	110,000	150,000	48,000	2,210	35	NTN

Reference	d	D	B	Kg		Brands
562022/GNP5	110,000	170,000	72,000	5,350	35	NTN
562924/GNP4	120,000	124,000	180,000	5,730	35	NTN
562024/GNP5	120,000	180,000	72,000	5,350	35	NTN
562928/GNP4	140,000	190,000	60,000	4,380	35	NTN
562028/GNP4	140,000	210,000	84,000	9,100	35	NTN
562028/GNP5	140,000	210,000	84,000	9,100	35	NTN
562930/GNP4	150,000	210,000	72,000	6,880	35	NTN
562930/GNP5	150,000	210,000	72,000	6,880	35	NTN
562030/GNP4	150,000	225,000	90,000	11,200	35	NTN
562030/GNP4	150,000	225,000	90,000	11,200	35	NTN
562030/GNP5	150,000	225,000	90,000	11,200	35	NTN
562932/GNP4	160,000	220,000	72,000	7,260	35	NTN
562032/GNP5	160,000	240,000	96,000	13,081	35	NTN
562032/GNP4	160,000	240,000	96,000	13,081	35	NTN
562032/GNP5	160,000	240,000	96,000	13,081	35	NTN
562934/GNP4	170,000	230,000	72,000	7,358	35	NTN
562034/GNP4	170,000	260,000	108,000	18,500	35	NTN
562034/GNP5	170,000	260,000	108,000	18,500	35	NTN
562936/GNP4	180,000	250,000	84,000	10,855	35	NTN
562036/GNP4	180,000	280,000	120,000	23,700	35	NTN
562036/GNP5	180,000	280,000	120,000	24,700	35	NTN
562938/GNP5	190,000	260,000	84,000	11,462	35	NTN
562038/GNP4	190,000	290,000	120,000	25,500	35	NTN
562940/GNP4	200,000	280,000	96,000	15,500	35	NTN
562040/GNP4	200,000	310,000	132,000	31,600	35	NTN
562944/GNP4	220,000	300,000	96,000	17,700	35	NTN
562044/GNP4	220,000	340,000	144,000	42,800	35	NTN
562948W4/GNP4	240,000	320,000	96,000	19,000	35	NTN
562048/GNP4	240,000	360,000	144,000	45,800	35	NTN
562960/GNP5	300,000	420,000	144,000	55,000	35	NTN
562964/GNP5	320,000	440,000	144,000	58,100	35	NTN
742016/GNP4	80,000	125,000	45,000	1,730	35	NTN
742018/GNP4	90,000	140,000	50,000	2,390	35	NTN
742920/GNP4	100,000	140,000	40,000	1,560	35	NTN
742020/GNP4	100,000	150,000	50,000	2,550	35	NTN
742024/GNP4	110,000	170,000	60,000	4,500	35	NTN
742028/GNP4	140,000	210,000	69,000	7,040	35	NTN
742030/GNP4	150,000	225,000	75,000	8,780	35	NTN
742032/GNP4	160,000	240,000	80,000	10,420	35	NTN
742936/GNP4	180,000	250,000	69,000	8,650	35	NTN
742036/GNP4	180,000	280,000	100,000	18,500	35	NTN
N1028HSKCONAP4	140,000	210,000	33,000	4,120	20	NTN
N1028HSK1NAP5	140,000	210,000	33,000	4,120	20	NTN
NN3005C1NAP4	25,000	47,000	16,000	0,124	24	NTN
NN3005KC1NAP4	25,000	47,000	16,000	0,121	24	NTN
NN3006C1NAP4	30,000	55,000	19,000	0,199	24	NTN
NN3006KC1NAP4	30,000	55,000	19,000	0,193	24	NTN
NN3007C1NAP4	35,000	62,000	20,000	0,242	24	NTN
NN3007KC1NAP4	35,000	62,000	20,000	0,235	24	NTN
NN3008C1NAP4	40,000	68,000	21,000	0,312	24	NTN
NN3008KC1NAP4	40,000	68,000	21,000	0,303	24	NTN

Reference	d	D	B	Kg		Brands
NN3009C1NAP4	45,000	75,000	23,000	0,405	24	NTN
NN3009KC1NAP4	45,000	75,000	23,000	0,393	24	NTN
NN3010C1NAP4	50,000	80,000	23,000	0,433	24	NTN
NN3010KC1NAP4	50,000	80,000	23,000	0,419	24	NTN
NN3011C1NAP4	55,000	90,000	26,000	0,651	24	NTN
NN3011KC1NAP4	55,000	90,000	26,000	0,631	24	NTN
NN3012C1NAP4	60,000	95,000	26,000	0,704	24	NTN
NN3012KC1NAP4	60,000	95,000	26,000	0,683	24	NTN
NN3013C1NAP4	65,000	100,000	26,000	0,758	24	NTN
NN3013KC1NAP4	65,000	100,000	26,000	0,735	24	NTN
NN3014C1NAP4	70,000	110,000	30,000	1,040	24	NTN
NN3014KC1NAP4	70,000	110,000	30,000	1,010	24	NTN
NN3015C1NAP4	75,000	115,000	30,000	1,140	24	NTN
NN3015KC1NAP4	75,000	115,000	30,000	1,110	24	NTN
NN3016C1NAP4	80,000	125,000	34,000	1,520	24	NTN
NN3016KC1NAP4	80,000	125,000	34,000	1,470	24	NTN
NN3017C1NAP4	85,000	130,000	34,000	1,610	24	NTN
NN3017KC1NAP4	85,000	130,000	34,000	1,560	24	NTN
NN3018C1NAP4	90,000	140,000	37,000	2,070	24	NTN
NN3018KC1NAP4	90,000	140,000	37,000	2,010	24	NTN
NN3019C1NAP4	95,000	145,000	37,000	2,170	24	NTN
NN3019KC1NAP4	95,000	145,000	37,000	2,100	24	NTN
NN3020C1NAP4	100,000	150,000	37,000	2,260	24	NTN
NN3020KC1NAP4	100,000	150,000	37,000	2,260	24	NTN
NN3021C1NAP4	105,000	160,000	41,000	2,890	24	NTN
NN3021KC1NAP4	105,000	160,000	41,000	2,890	24	NTN
NN3022C1NAP4	110,000	170,000	45,000	3,690	24	NTN
NN3022KC1NAP4	110,000	170,000	45,000	3,690	24	NTN
NN3022C1NAP4	110,000	170,000	45,000	3,870	25	NTN
NN3022KC1NAP4	110,000	170,000	45,000	3,870	25	NTN
NN3024C1NAP4	120,000	180,000	46,000	3,980	24	NTN
NN3024KC1NAP4	120,000	180,000	46,000	3,980	24	NTN
NN3024C1NAP4	120,000	180,000	46,000	4,240	25	NTN
NN3026C1NAP4	130,000	200,000	52,000	5,820	24	NTN
NN3026KC1NAP4	130,000	200,000	52,000	5,920	24	NTN
NN3026C1NAP4	130,000	200,000	52,000	6,150	25	NTN
NN3028C1NAP4	140,000	210,000	53,000	6,236	24	NTN
NN3028C1NAP5	140,000	210,000	53,000	6,236	24	NTN
NN3028C2NAP5	140,000	210,000	53,000	6,236	24	NTN
NN3028KC0NAP4	140,000	210,000	53,000	6,076	24	NTN
NN3028KC1NAP4	140,000	210,000	53,000	6,076	24	NTN
NN3028KC1NAP5	140,000	210,000	53,000	6,076	24	NTN
NN3028C9NAP4	140,000	210,000	53,000	6,076	24	NTN
NN3028C9NAP5	140,000	210,000	53,000	6,076	24	NTN
NN3028C1NAP4	140,000	210,000	53,000	5,910	25	NTN
NN3930KD1C9NAP4	150,000	210,000	45,000	4,430	24	NTN
NN3030C1NAP4	150,000	225,000	56,000	7,628	24	NTN
NN3030C1NAP5	150,000	225,000	56,000	7,682	24	NTN
NN3030HSC0NAP4	150,000	225,000	56,000	7,402	24	NTN
NN3030KC0NAP4	150,000	225,000	56,000	7,402	24	NTN
NN3030KC1NAP4	150,000	225,000	56,000	7,402	24	NTN
NN3030KC1NAP5	150,000	225,000	56,000	7,402	24	NTN

Reference	d	D	B	Kg		Brands
NN3030KC9NAP5	150,000	225,000	56,000	7,402	24	NTN
NN3030C1NAP4	150,000	225,000	56,000	8,060	25	NTN
NN3032C1NAP4	160,000	240,000	60,000	9,175	24	NTN
NN3032C1NAP5	160,000	240,000	60,000	9,175	24	NTN
NN3032CS6S4	160,000	240,000	60,000	9,175	24	NTN
NN3032HSC0NAP4	160,000	240,000	60,000	8,620	24	NTN
NN3032KC0NAP4	160,000	240,000	60,000	9,060	24	NTN
NN3032KC1NAP4	160,000	240,000	60,000	9,060	24	NTN
NN3032KC1NAP5	160,000	240,000	60,000	9,060	24	NTN
NN3032KC9NAP4	160,000	240,000	60,000	9,060	24	NTN
NN3032KD1C0NAP4	160,000	240,000	60,000	8,590	24	NTN
NN3032KP4V3	160,000	240,000	60,000	9,055	24	NTN
NN3034C1NAP4	170,000	260,000	67,000	12,337	24	NTN
NN3034C1NAP5	170,000	260,000	67,000	12,337	24	NTN
NN3034C9NAP4	170,000	260,000	67,000	12,337	24	NTN
NN3034C9NAP5	170,000	260,000	67,000	12,337	24	NTN
NN3034C1NAP4	170,000	260,000	67,000	12,600	24	NTN
NN3034C1NAP4	170,000	260,000	67,000	13,200	25	NTN
NN3034C1NAP4	170,000	260,000	67,000	13,300	25	NTN
NN3036C1NAP4	180,000	280,000	74,000	16,900	24	NTN
NN3036C1NAP5	180,000	280,000	74,000	16,900	24	NTN
NN3036KC1NAP4	180,000	280,000	74,000	16,300	24	NTN
NN3036KC1NAP5	180,000	280,000	74,000	16,400	24	NTN
NN3036KC9NAP4	180,000	280,000	74,000	16,400	24	NTN
NN3036KC9NAP5	180,000	280,000	74,000	16,400	24	NTN
NN3036C1NAP4	180,000	280,000	74,000	17,400	25	NTN
NN3038C1NAP5	190,000	290,000	75,000	17,900	24	NTN
NN3038KC1NAP4	190,000	290,000	75,000	17,400	24	NTN
NN3038KC1NAP5	190,000	290,000	75,000	17,400	24	NTN
NN3038C9NAP4	190,000	290,000	75,000	17,400	24	NTN
NN3038C9NAP5	190,000	290,000	75,000	17,400	24	NTN
NN3038C1NAP4	190,000	290,000	75,000	12,700	24	NTN
NN3038C1NAP4	190,000	290,000	75,000	18,400	25	NTN
NN3040C1NAP4	200,000	310,000	82,000	22,900	24	NTN
NN3040C1NAP5	200,000	310,000	82,000	22,800	24	NTN
NN3040KC0NAP4	200,000	310,000	82,000	22,200	24	NTN
NN3040KC1NAP4	200,000	310,000	82,000	22,200	24	NTN
NN3040KC1NAP5	200,000	310,000	82,000	22,200	24	NTN
NN3040KC9NAP4	200,000	310,000	82,000	22,200	24	NTN
NN3040KC9NAP5	200,000	310,000	82,000	22,200	24	NTN
NN3040P5	200,000	310,000	82,000	22,800	24	NTN
NN3040KC2NAP5	200,000	310,000	82,000	22,200	24	NTN
NN3040C1NAP4	200,000	310,000	82,000	23,500	25	NTN
NN3040KC1NAP4	200,000	310,000	82,000	23,000	25	NTN
NN3044C1NAP5	220,000	340,000	90,000	29,900	24	NTN
NN3044C1NAP4	220,000	340,000	90,000	29,100	24	NTN
NN3044KC1NAP5	220,000	340,000	90,000	29,100	24	NTN
NN3044KC9NAP4	220,000	340,000	90,000	29,100	24	NTN
NN3044KC9NAP5	220,000	340,000	90,000	29,100	24	NTN
NN3044KD1C0NAP5	220,000	340,000	90,000	29,100	24	NTN
NN3044C1NAP4	220,000	340,000	90,000	29,300	24	NTN
NN3044C1NAP4	220,000	340,000	90,000	31,000	25	NTN

Reference	d	D	B	Kg		Brands
NN3048KC1NAP4	240,000	360,000	92,000	31,600	24	NTN
NN3048KC1NAP5	240,000	360,000	92,000	31,600	24	NTN
NN3048KC9NAP4	240,000	360,000	92,000	31,600	24	NTN
NN3048KD1C1NAP5	240,000	360,000	92,000	31,600	24	NTN
NN3048C1NAP4	240,000	360,000	92,000	32,800	24	NTN
NNU3048C1NAP4	240,000	360,000	92,000	33,900	25	NTN
NN3052KC1NAP5	260,000	400,000	104,000	45,900	24	NTN
NN3052KC9NAP4	260,000	400,000	104,000	45,900	24	NTN
NN3052C1NAP4	260,000	400,000	104,000	47,400	24	NTN
NN3052KC1NAP4	260,000	400,000	104,000	47,400	24	NTN
NN3056KC1NAP5	280,000	420,000	106,000	49,800	24	NTN
NN3056KWD1C1NAP5	280,000	420,000	106,000	49,300	24	NTN
NN3056C1NAP4	280,000	420,000	106,000	51,100	24	NTN
NN3056KC1NAP4	280,000	420,000	106,000	51,100	24	NTN
NNU3056C1NAP4	280,000	420,000	106,000	51,300	25	NTN
NN3060KC1NAP5	300,000	460,000	118,000	69,240	24	NTN
NN3060C1NAP4	300,000	460,000	118,000	70,800	24	NTN
NN3060KC1NAP4	300,000	460,000	118,000	70,800	24	NTN
NNU3060C1NAP4	300,000	460,000	118,000	73,400	25	NTN
NN3064KD1C0NAP5	320,000	480,000	121,000	73,500	24	NTN
NN3064C1NAP4	320,000	480,000	121,000	76,200	24	NTN
NN3064KC1NAP4	320,000	480,000	121,000	76,200	24	NTN
NNU3064C1NAP4	320,000	480,000	121,000	79,300	25	NTN
NN3068KWD1C1NAP5	340,000	520,000	133,000	105,000	24	NTN
NN3068C1NAP4	340,000	520,000	133,000	102,000	24	NTN
NN3068KC1NAP4	340,000	520,000	133,000	102,000	24	NTN
NNU3068C1NAP4	340,000	520,000	133,000	105,000	25	NTN
NN3072KD1C0NAP4	360,000	540,000	134,000	104,000	24	NTN
NN3072C1NAP4	360,000	540,000	134,000	107,000	24	NTN
NN3072KC1NAP4	360,000	540,000	134,000	107,000	24	NTN
NNU3072C1NAP4	360,000	540,000	134,000	111,000	25	NTN
NN3076C1NAP4	380,000	560,000	135,000	113,000	24	NTN
NN3076KC1NAP4	380,000	560,000	135,000	113,000	24	NTN
NNU3076C1NAP4	380,000	560,000	135,000	117,000	25	NTN
NN3080KW-1D1C0NAP5	400,000	600,000	148,000	141,000	24	NTN
NN3080C1NAP4	400,000	600,000	148,000	146,000	24	NTN
NN3080KC1NAP4	400,000	600,000	148,000	146,000	24	NTN
NN3084C1NAP4	420,000	620,000	150,000	154,000	24	NTN
NN3084KC1NAP4	420,000	620,000	150,000	154,000	24	NTN
NN3088C1NAP4	440,000	650,000	157,000	178,000	24	NTN
NN3088KC1NAP4	440,000	650,000	157,000	178,000	24	NTN
NNU3088C1NAP4	440,000	650,000	157,000	185,650	25	NTN
NN3092KW-1D1C1NAP5	460,000	680,000	163,000	195,000	24	NTN
NN3092C1NAP4	460,000	680,000	163,000	202,000	24	NTN
NN3092KC1NAP4	460,000	680,000	163,000	202,000	24	NTN
NN30/500C1NAP4	500,000	720,000	167,000	221,000	24	NTN
NNU30/500C1NAP4	500,000	720,000	167,000	225,000	25	NTN
NNU30/560C1NAP4	560,000	820,000	195,000	358,000	25	NTN
NN30/600KW-3D1CS120P5	600,000	870,000	200,000	385,000	24	NTN
NNU30/600KWD1CSAP5	600,000	870,000	200,000	383,000	25	NTN
NN30/600C1NAP4	600,000	870,000	200,000	392,000	24	NTN
NN30/600KC1NAP4	600,000	870,000	200,000	385,000	24	NTN

Reference	d	D	B	Kg		Brands
NN30/710KWD1C1NAP5	710,000	1030,000	236,000	636,000	24	NTN
NN30/800KWD1CS140P5	800,000	1150,000	258,000	852,000	24	NTN
NN30/950KWD1C1NAP5	950,000	1360,000	300,000	1376,000	24	NTN
NN3126C1NAP4	130,000	210,000	64,000	8,590	24	NTN
NNU3130C1NAP4	150,000	250,000	80,000	16,400	25	NTN
NN3134C1NAP4	170,000	280,000	88,000	21,500	24	NTN
NNU3134C1NAP4	170,000	280,000	88,000	22,300	25	NTN
NN3140C1NAP4	200,000	340,000	112,000	41,800	24	NTN
NN3144C1NAP4	220,000	370,000	120,000	52,400	24	NTN
NNU3144C1NAP4	220,000	370,000	120,000	54,400	25	NTN
NN3148C1NAP4	240,000	400,000	128,000	64,700	24	NTN
NNU3164C1NAP4	320,000	540,000	176,000	170,000	25	NTN
NNU3184C1NAP4	420,000	700,000	224,000	359,000	25	NTN
NN3196C1NAP4	480,000	790,000	248,000	482,000	24	NTN
NNU3856C1NAP4	280,000	350,000	52,000	11,700	25	NTN
NN3896C1NAP4	480,000	600,000	90,000	57,500	24	NTN
NNU38/500C1NAP4	500,000	620,000	90,000	61,900	25	NTN
NN38/530C1NAP4	530,000	650,000	90,000	62,900	24	NTN
NN38/560C1NAP4	560,000	680,000	90,000	66,100	24	NTN
NNF38/560C1NAP4	560,000	680,000	90,000	61,000	24	NTN
NNU38/750C1NAP4	750,000	920,000	128,000	186,000	25	NTN
NNU38/800C1NAP4	800,000	980,000	136,000	223,000	25	NTN
NN3922C1NAP4	110,000	150,000	30,000	1,540	24	NTN
NN3926C1NAP4	130,000	180,000	37,000	2,829	24	NTN
NN3926KC1NAP4	130,000	180,000	37,000	2,800	24	NTN
NN3928C1NAP4	140,000	190,000	37,000	3,010	24	NTN
NN3930C1NAP4	150,000	210,000	45,000	4,790	24	NTN
NN3930KC1NAP4	150,000	210,000	45,000	4,430	24	NTN
NN3932C1NAP4	160,000	220,000	45,000	5,060	24	NTN
NN3932KC1NAP4	160,000	220,000	45,000	5,060	24	NTN
NN3934C1NAP4	170,000	230,000	45,000	5,330	24	NTN
NN3934KC1NAP4	170,000	230,000	45,000	5,330	24	NTN
NN3936C1NAP4	180,000	250,000	52,000	7,720	24	NTN
NN3936KC1NAP4	180,000	250,000	52,000	7,720	24	NTN
NN3938C1NAP4	190,000	260,000	52,000	8,080	24	NTN
NN3940KC9NAP4	200,000	280,000	60,000	11,300	24	NTN
NN3940C1NAP4	200,000	280,000	60,000	11,400	24	NTN
NN3940KC1NAP4	200,000	280,000	60,000	11,300	24	NTN
NN3944C1NAP4	220,000	300,000	60,000	12,300	24	NTN
NN3944KC1NAP4	220,000	300,000	60,000	12,300	24	NTN
NN3948KC9NAP4	240,000	320,000	60,000	12,900	24	NTN
NN3948C1NAP4	240,000	320,000	60,000	13,300	24	NTN
NN3948KC1NAP4	240,000	320,000	60,000	13,300	24	NTN
NNU3948C1NAP4	240,000	320,000	60,000	13,800	25	NTN
NN3952KC9NAP4	260,000	360,000	75,000	22,200	24	NTN
NN3952C1NAP4	260,000	360,000	75,000	22,900	24	NTN
NN3952KC1NAP4	260,000	360,000	75,000	22,900	24	NTN
NN3956C1NAP4	280,000	380,000	75,000	24,400	24	NTN
NN3956KC1NAP4	280,000	380,000	75,000	24,400	24	NTN
NN3960KC9NAP4	300,000	420,000	90,000	37,820	24	NTN
NN3960C1NAP4	300,000	420,000	90,000	38,400	24	NTN
NN3960KC1NAP4	300,000	420,000	90,000	38,400	24	NTN



Reference	d	D	B	Kg		Brands
NN3964K9NAP4	320,000	440,000	90,000	39,920	24	NTN
NN3964C1NAP4	320,000	440,000	90,000	40,500	24	NTN
NN3964K1NAP4	320,000	440,000	90,000	40,500	24	NTN
NN3972K9NAP4	360,000	480,000	90,000	45,000	24	NTN
NN3972C1NAP4	360,000	480,000	90,000	44,800	24	NTN
NN3972K1NAP4	360,000	480,000	90,000	45,000	24	NTN
NN3976K9NAP4	380,000	520,000	106,000	66,200	24	NTN
NN3976K1NAP4	380,000	520,000	106,000	66,200	24	NTN
NN3980C1NAP4	400,000	540,000	106,000	70,720	24	NTN
NN3984C1NAP4	420,000	560,000	106,000	71,700	24	NTN
NNU39/800C1NAP4	800,000	1060,000	195,000	483,000	25	NTN
NN4030C1NAP4	150,000	225,000	75,000	10,400	24	NTN
NN4040C1NAP4	200,000	310,000	109,000	30,200	24	NTN
NN4052C1NAP4	260,000	400,000	140,000	63,800	24	NTN
NNU4052C1NAP4	260,000	400,000	140,000	66,200	25	NTN
NN4060C1NAP4	300,000	460,000	160,000	96,000	24	NTN
NNU4064C1NAP4	320,000	480,000	160,000	103,000	25	NTN
NNU4072C1NAP4	360,000	540,000	180,000	136,000	25	NTN
NNU4088C1NAP4	440,000	650,000	212,000	247,000	25	NTN
NNU4856C1NAP4	280,000	350,000	69,000	15,600	25	NTN
NNU4856K1NAP4	280,000	350,000	69,000	15,600	25	NTN
NNU4864C1NAP4	320,000	400,000	80,000	23,600	25	NTN
NNU4880C1NAP4	400,000	500,000	100,000	46,100	25	NTN
NNU48/600C1NAP4	600,000	730,000	128,000	113,000	25	NTN
NNU48/630C1NAP4	630,000	780,000	150,000	162,000	25	NTN
NN4920C1NAP4	100,000	140,000	40,000	1,750	24	NTN
NN4920K1NAP4	100,000	140,000	40,000	1,750	24	NTN
NNU4920C1NAP4	100,000	140,000	40,000	1,910	25	NTN
NNU4920K1NAP4	100,000	140,000	40,000	1,830	25	NTN
NN4921C1NAP4	105,000	145,000	40,000	1,820	24	NTN
NN4921K1NAP4	105,000	145,000	40,000	1,820	24	NTN
NNU4921C1NAP4	105,000	145,000	40,000	1,910	25	NTN
NNU4921K1NAP4	105,000	145,000	40,000	1,910	25	NTN
NN4922C1NAP4	110,000	150,000	40,000	1,900	24	NTN
NN4922K1NAP4	110,000	150,000	40,000	1,900	24	NTN
NNU4922C1NAP4	110,000	150,000	40,000	1,990	25	NTN
NNU4922K1NAP4	110,000	150,000	40,000	1,990	25	NTN
NN4924C1NAP4	120,000	165,000	45,000	2,630	24	NTN
NN4924K1NAP4	120,000	165,000	45,000	2,630	24	NTN
NNU4924C1NAP4	120,000	165,000	45,000	2,750	25	NTN
NNU4924K1NAP4	120,000	165,000	45,000	2,630	25	NTN
NN4926C1NAP4	130,000	180,000	50,000	3,520	24	NTN
NN4926K1NAP4	130,000	180,000	50,000	3,520	24	NTN
NNU4926C1NAP4	130,000	180,000	50,000	3,690	25	NTN
NNU4926K1NAP4	130,000	180,000	50,000	3,520	25	NTN
NN4928C1NAP4	140,000	190,000	50,000	3,760	24	NTN
NN4928K1NAP4	140,000	190,000	50,000	3,760	24	NTN
NNU4928C1NAP4	140,000	190,000	50,000	3,940	25	NTN
NNU4928K1NAP4	140,000	190,000	50,000	3,760	25	NTN
NN4930HSC1NAP5	150,000	210,000	60,000	5,900	24	NTN
NN4930HSC3NAP5	150,000	210,000	60,000	5,900	24	NTN
NN4930HSCONAP4	150,000	210,000	60,000	5,900	24	NTN

Reference	d	D	B	Kg		Brands
NN4930HSC1NAP4	150,000	210,000	60,000	5,900	21	NTN
NNU4930C1NAP4	150,000	210,000	60,000	6,180	25	NTN
NNU4930C1NAP5	150,000	210,000	60,000	6,180	25	NTN
NNU4930C2NAP5	150,000	210,000	60,000	6,180	25	NTN
NNU4930K1NAP4	150,000	210,000	60,000	5,900	25	NTN
NNU4930K1NAP5	150,000	210,000	60,000	6,180	25	NTN
NNU4930KD1C0NAP5	150,000	210,000	60,000	5,900	25	NTN
TS3-NNU4930KD1NAP5	150,000	210,000	60,000	5,900	25	NTN
NN4930C1NAP4	150,000	210,000	60,000	5,900	24	NTN
NN4930K1NAP4	150,000	210,000	60,000	5,900	24	NTN
NN4932K1NAP4	160,000	220,000	60,000	5,940	21	NTN
NNU4932C1NAP4	160,000	220,000	60,000	6,530	25	NTN
NNU4932K1NAP4	160,000	220,000	60,000	6,230	25	NTN
TS3-NNU4932KD1NAP5	160,000	220,000	60,000	6,230	25	NTN
NN4932C1NAP4	160,000	220,000	60,000	6,240	24	NTN
NN4932K1NAP4	160,000	220,000	60,000	6,240	24	NTN
NN4934C3NAP5	170,000	230,000	60,000	6,560	24	NTN
NN4934HSC1NAP4	170,000	230,000	60,000	6,240	24	NTN
NN4934K9NAP4	170,000	230,000	60,000	6,240	24	NTN
NNU4934C1NAP5	170,000	230,000	60,000	6,870	25	NTN
NNU4934K1NAP5	170,000	230,000	60,000	6,550	25	NTN
NN4934C1NAP4	170,000	230,000	60,000	6,560	24	NTN
NN4934K1NAP4	170,000	230,000	60,000	6,560	24	NTN
NNU4934C1NAP4	170,000	230,000	60,000	6,870	25	NTN
NNU4934K1NAP4	170,000	230,000	60,000	6,550	25	NTN
NN4936KW4CS30P4	180,000	250,000	69,000	9,674	24	NTN
NNU4936C1NAP4	180,000	250,000	69,000	9,900	25	NTN
NNU4936C1NAP5	180,000	250,000	69,000	9,900	25	NTN
NNU4936K1NAP4	180,000	250,000	69,000	9,460	25	NTN
NNU4936KD1XC0NAP4	180,000	250,000	69,000	9,460	25	NTN
NN4936C1NAP4	180,000	250,000	69,000	9,450	24	NTN
NN4936K1NAP4	180,000	250,000	69,000	9,450	24	NTN
NN4938KCS30P4	190,000	260,000	69,000	10,358	24	NTN
NN4938KD1C1NAP4	190,000	260,000	69,000	10,358	24	NTN
NNU4938ADNAP5	190,000	260,000	69,000	9,900	25	NTN
NNU4938C1NAP4	190,000	260,000	69,000	9,900	25	NTN
NNU4938KCS95P5	190,000	260,000	69,000	9,900	25	NTN
TS3-NNU4938KD1NAP5	190,000	260,000	69,000	9,940	25	NTN
NN4938C1NAP4	190,000	260,000	69,000	9,930	24	NTN
NN4938K1NAP4	190,000	260,000	69,000	9,930	24	NTN
NNU4938K1NAP4	190,000	260,000	69,000	9,940	25	NTN
NN4940KD1C1NAP5	200,000	280,000	80,000	14,400	24	NTN
NNU4940C1NAP4	200,000	280,000	80,000	15,250	25	NTN
NNU4940C1NAP5	200,000	280,000	80,000	15,300	25	NTN
NNU4940K1NAP4	200,000	280,000	80,000	15,100	25	NTN
NN4940C1NAP4	200,000	280,000	80,000	14,000	24	NTN
NN4940K1NAP4	200,000	280,000	80,000	14,000	24	NTN
NN4944HSCD1C0NAP4	220,000	300,000	80,000	14,500	24	NTN
NNU4944C1NAP4	220,000	300,000	80,000	19,000	25	NTN
NNU4944C1NAP5	220,000	300,000	80,000	16,900	25	NTN
NNU4944D1C2NAP5	220,000	300,000	80,000	16,900	25	NTN
NNU4944D1C2P5	220,000	300,000	80,000	16,900	25	NTN

Reference	d	D	B	Kg	?	Brands
NUU4944KC1NAP5	220,000	300,000	80,000	15,900	25	NTN
NNUP4944D1C2P5	220,000	300,000	80,000	16,200	25	NTN
NN4944C1NAP4	220,000	300,000	80,000	15,200	24	NTN
NN4944KC1NAP4	220,000	300,000	80,000	15,200	24	NTN
NNU4944KC1NAP4	220,000	300,000	80,000	15,900	25	NTN
NN4948HSD1XC9NAP4	240,000	320,000	80,000	15,600	24	NTN
NN4948KW4CS30P4	240,000	320,000	80,000	16,500	24	NTN
NN4948C1NAP4	240,000	320,000	80,000	16,400	24	NTN
NN4948KC1NAP4	240,000	320,000	80,000	16,400	24	NTN
NNU4948C1NAP4	240,000	320,000	80,000	17,700	25	NTN
NNU4948KC1NAP4	240,000	320,000	80,000	17,200	25	NTN
NNU4952KC1NAP5	260,000	360,000	100,000	28,200	24	NTN
NNU4952KD1C1NAP5	260,000	360,000	100,000	28,300	25	NTN
NN4952C1NAP4	260,000	360,000	100,000	28,300	24	NTN
NN4952KC1NAP4	260,000	360,000	100,000	28,300	24	NTN
NNU4952C1NAP4	260,000	360,000	100,000	29,600	25	NTN
NNU4952KC1NAP4	260,000	360,000	100,000	29,600	25	NTN
NN4956C1NAP4	280,000	380,000	100,000	30,200	24	NTN
NN4956KC1NAP4	280,000	380,000	100,000	30,200	24	NTN
NNU4956C1NAP4	280,000	380,000	100,000	33,100	25	NTN
NNU4956KC1NAP4	280,000	380,000	100,000	31,600	25	NTN
NN4960K9NAP5	300,000	420,000	118,000	44,200	24	NTN
NNU4960KC1NAP5	300,000	420,000	118,000	49,600	25	NTN
NN4960C1NAP4	300,000	420,000	118,000	46,400	24	NTN
NN4960KC1NAP4	300,000	420,000	118,000	46,400	24	NTN
NNU4960C1NAP4	300,000	420,000	118,000	48,600	25	NTN
NNU4960KC1NAP4	300,000	420,000	118,000	48,600	25	NTN
NNU4964C1NAP5	320,000	440,000	118,000	51,400	25	NTN
NNU4964KC1NAP5	320,000	440,000	118,000	49,100	25	NTN
NNU4964KD1C1NAP5	320,000	440,000	118,000	49,100	25	NTN
NNU4964KWD1X2C9NAP5	320,000	440,000	118,000	49,100	25	NTN
NN4964C1NAP4	320,000	440,000	118,000	49,000	24	NTN
NN4964KC1NAP4	320,000	440,000	118,000	49,000	24	NTN
NNU4964C1NAP4	320,000	440,000	118,000	51,400	25	NTN
NNU4964KC1NAP4	320,000	440,000	118,000	51,400	25	NTN
NN4968KD1C0NAP5	340,000	460,000	118,000	51,600	24	NTN
NN4968KWD1XC9NAP5	340,000	460,000	118,000	51,600	24	NTN
NNU4968D1C3P4	340,000	460,000	118,000	54,200	24	NTN
NN4968C1NAP4	340,000	460,000	118,000	52,200	24	NTN
NN4968KC1NAP4	340,000	460,000	118,000	52,200	24	NTN
NNU4968C1NAP4	340,000	460,000	118,000	54,200	25	NTN
NNU4968KC1NAP4	340,000	460,000	118,000	54,200	25	NTN
NNU4972C1NAP4	360,000	480,000	118,000	57,000	25	NTN
NNU4972KC1NAP4	360,000	480,000	118,000	57,000	25	NTN
NNU4976C1NAP4	380,000	520,000	140,000	84,500	25	NTN
NNU4976KC1NAP4	380,000	520,000	140,000	84,500	25	NTN
NNU4980KD1C1NAP5	400,000	540,000	140,000	88,200	25	NTN
NNU4980C1NAP4	400,000	540,000	140,000	95,000	25	NTN
NNU4980KC1NAP4	400,000	540,000	140,000	88,200	25	NTN
NNU4984KD1C1NAP5	420,000	560,000	140,000	87,700	24	NTN
NNU4984KW-1D1C0NAP5	420,000	560,000	140,000	87,700	25	NTN
NNU4984C1NAP4	420,000	560,000	140,000	97,200	25	NTN

Reference	d	D	B	Kg	?	Brands
NNU4984KC1NAP4	420,000	560,000	140,000	92,000	25	NTN
NNU4988C1NAP4	440,000	600,000	160,000	127,000	25	NTN
NNU4988KC1NAP4	440,000	600,000	160,000	127,000	25	NTN
NNU4992KWD1C0NAP5	460,000	620,000	160,000	126,000	25	NTN
NNU4992C1NAP4	460,000	620,000	160,000	132,000	25	NTN
NNU4992KC1NAP4	460,000	620,000	160,000	126,000	25	NTN
NNU4996C1NAP4	480,000	650,000	170,000	156,000	25	NTN
NNU4996KC1NAP4	480,000	650,000	170,000	149,000	25	NTN
NNU49/500KD1X2C1NAP5	500,000	670,000	170,000	163,000	25	NTN
NNU49/500C1NAP4	500,000	670,000	170,000	162,000	25	NTN
NNU49/500KC1NAP4	500,000	670,000	170,000	162,000	25	NTN
NN49/530C1NAP4	530,000	710,000	180,000	205,000	24	NTN
NNU49/530C1NAP4	530,000	710,000	180,000	206,000	25	NTN
NNU49/530KC1NAP4	530,000	710,000	180,000	206,000	25	NTN
NNU49/560KWD1XC0NAP4	560,000	750,000	190,000	230,000	25	NTN
NNU49/560C1NAP4	560,000	750,000	190,000	233,000	24	NTN
NNU49/560KC1NAP4	560,000	750,000	190,000	242,000	25	NTN
NNU49/560KC1NAP4	560,000	750,000	190,000	242,000	25	NTN
NNU49/600KWD1C1NAP5	600,000	800,000	200,000	276,000	25	NTN
NNU49/600C1NAP4	600,000	800,000	200,000	287,000	25	NTN
NN49/630KWD1XC1NAP5	630,000	850,000	218,000	341,000	21	NTN
NNU49/710C1NAP4	710,000	950,000	243,000	489,000	25	NTN
NNU49/750KP5V1	750,000	1000,000	250,000	529,000	25	NTN
NNU49/750C1NAP4	750,000	1000,000	250,000	560,000	25	NTN
NN49/800KP5V1	800,000	1060,000	258,000	603,000	24	NTN
NN49/950C1NAP4	950,000	1250,000	300,000	977,000	24	NTN



Classification by dimensions – Classement par dimensions
Klassifizierung nach Abmessungen – Classificazione per dimensione
Clasificación por dimensiones – Classificação por dimensões
Классификация по размерам – Klasyfikacja wg wymiarów

 Ball bearing

 Rillenkugellager

 Rodamientos
de bolas

 Шарикоподшипники

 Roulements
à billes

 Cuscinetti a sfera

 Rolamentos
de esferas

 Łożyska kulkowe



d	D	B	Kg	Reference					
1,500	4,000	1,200	0,07	68/15	1	NTN			
	5,000	2,000	0,18	69/15A	1	NTN			
	5,000	2,000	0,002	F-W69/15ASSA	1	NTN			
	6,000	2,500	0,001	60/15	1	NTN			
2,000	4,000	1,200	0,001	672	1	NTN			
	5,000	1,500	0,001	682	1	NTN			
	5,000	1,500	0,000	F-682	1	NTN			
	5,000	2,000	0,16	BC2-5	1	NTN			
	5,000	2,000	0,000	F-B-5	1	NTN			
	5,000	2,300	0,000	F-FLW682SSA	1	NTN			
	5,000	2,300	0,000	F-W682SSA	1	NTN			
	5,000	2,300	0,000	W682SSA	1	NTN			
	5,000	2,500	0,000	WB-5SSA	1	NTN			
	6,000	2,300	0,001	692	1	NTN			
	6,000	2,300	0,000	F-692	1	NTN			
	6,000	2,500	0,32	BC2-6	1	NTN			
	6,000	2,500	0,000	F-B-6	1	NTN			
	6,000	3,000	0,000	W692SSA	1	NTN			
	7,000	2,500	0,44	BC2-7A	1	NTN			
	7,000	2,800	0,001	602	1	NTN			
2,380	4,762	1,588	0,35	R1-4	1	NTN			
	7,938	2,779	0,12	R133	1	NTN			
2,500	5,000	1,500	0,11	67/25	1	NTN			
	6,000	1,800	0,22	68/25	1	NTN			
	7,000	2,500	0,43	69/25	1	NTN			
	8,000	2,500	0,57	BC25-8	1	NTN			
	8,000	2,800	0,72	60/25	1	NTN			
3,000	6,000	2,000	0,001	673	1	NTN			
	6,000	2,000	0,000	F-673	1	NTN			
	6,000	2,500	0,000	F-FLWA673SSA	1	NTN			
	6,000	2,500	0,000	F-WA673SSA	1	NTN			
	6,000	2,500	0,000	WA673SSA	1	NTN			
	7,000	2,000	0,001	683	1	NTN			
	7,000	2,000	0,000	F-683	1	NTN			
	7,000	3,000	0,000	F-FLW683ZZ	1	NTN			
	7,000	3,000	0,001	F-W683ZZ	1	NTN			
	7,000	3,000	0,001	W683ZZ	1	NTN			
	8,000	2,500	0,52	BC3-8	1	NTN			
	8,000	3,000	0,001	693	1	NTN			
	8,000	3,000	0,001	F-693	1	NTN			
	8,000	3,000	0,001	F-FL693	1	NTN			
	8,000	4,000	0,001	F-FLW693ZZ	1	NTN			
	8,000	4,000	0,001	F-W693ZZ	1	NTN			
	8,000	4,000	0,001	F-W693ZZS	1	NTN			
	8,000	4,000	0,002	SX3A41	2	NTN			
	8,000	4,000	0,001	W693Z	1	NTN			
	8,000	4,000	0,001	W693ZZ	1	NTN			
	9,000	2,500	0,71	BC3-9	1	NTN			
	9,000	3,000	0,001	603	1	NTN			
	9,000	3,000	0,001	F-603	1	NTN			
	9,000	5,000	0,002	F-W603ZZ	1	NTN			
	10,000	4,000	0,002	623	1	NTN-SNR			
	10,000	4,000	0,002	623EE	1	SNR			
	10,000	4,000	0,002	623Z	1	SNR			
	10,000	4,000	0,002	623ZZ	1	NTN-SNR			
	10,000	4,000	0,002	F-623ZZ	1	NTN			
	10,000	4,000	0,002	F-FL623ZZ	1	NTN			

d	D	B	Kg	Reference					
3,175	6,350	2,380	0,69	R1-5	1	NTN			
	6,350	2,779	0,000	F-S75	1	NTN			
	7,938	2,779	0,27	R144	1	NTN			
	9,525	2,779	0,61	R2-5	1	NTN			
	9,525	3,967	0,88	R2-6	1	NTN			
	9,525	3,967	0,001	R2ZZA	1	NTN			
	12,700	4,366	1,30	R2	1	NTN			
3,967	7,938	2,779	2,50	RA2	1	NTN			
4,000	7,000	2,000	0,28	674A	1	NTN			
	7,000	2,000	0,000	F-674	1	NTN			
	7,000	2,500	0,000	F-FLWA674ASSA	1	NTN			
	7,000	2,500	0,004	FLWA674SSA	1	NTN			
	7,000	2,500	0,000	F-WA674ASSA	1	NTN			
	7,000	2,500	0,000	WA674AZZ	1	NTN			
	8,000	2,000	0,38	BC4-8	1	NTN			
	8,000	2,000	0,000	F-B-8	1	NTN			
	8,000	2,000	0,001	F-FLB-8	1	NTN			
	8,000	2,000	0,005	FLB-8	1	NTN			
	8,000	3,000	0,001	F-FLWB-8ZZ	1	NTN			
	8,000	3,000	0,001	FLWB-8ZZ	1	NTN			
	8,000	3,000	0,001	F-WB-8ZZ	1	NTN			
	8,000	3,000	0,001	WB-8ZZ	1	NTN			
	9,000	2,500	0,67	684AX50	1	NTN			
	9,000	2,500	0,001	F-684	1	NTN			
	9,000	4,000	0,001	F-FLW684ASSA	1	NTN			
	9,000	4,000	0,001	F-W684AZZ	1	NTN			
	9,000	4,000	0,001	W684ASSA	1	NTN			
	10,000	3,000	1,00	BC4-10	1	NTN			
	10,000	3,000	0,001	F-B-10	1	NTN			
	10,000	4,000	0,001	F-FLAWB-10ZZ	1	NTN			
	10,000	4,000	0,001	FLAWB-10ZZ	1	NTN			
	10,000	4,000	0,001	F-WB-10ZZ	1	NTN			
	10,000	4,000	0,001	WB-10ZZ	1	NTN			
	11,000	4,000	0,002	694	1	NTN			
	11,000	4,000	0,002	694ZZ	1	NTN			
	11,000	4,000	0,002	F-694	1	NTN			
11,000	4,000	0,002	F-694ZZ	1	NTN				
11,000	4,000	0,002	F-FL694ZZ	1	NTN				
12,000	4,000	0,002	604	1	NTN				
12,000	4,000	0,002	604ZZ	1	NTN				
12,000	4,000	0,002	F-604ZZ	1	NTN				
12,000	4,000	0,002	F-FL604ZZ	1	NTN				
12,700	7,000	0,004	SC414ZZ	1	NTN				
13,000	5,000	0,003	624	1	NTN-SNR				
13,000	5,000	0,01	624EE	1	SNR				
13,000	5,000	0,003	624ZZ	1	NTN-SNR				
13,000	5,000	0,003	F-624ZZ	1	NTN				
13,000	5,000	0,004	SC4A28ZZ	1	NTN				
16,000	5,000	0,01	634	1	NTN-SNR				
16,000	5,000	0,01	634EE	1	SNR				
16,000	5,000	0,01	634Z	1	NTN				
16,000	5,000	0,01	634ZZ	1	NTN-SNR				
18,000	6,000	0,002	SX4A07ZZ	2	NTN				
4,762	7,938	2,779	0,54	R155	1	NTN			
	9,525	3,175	0,44	R156	1	NTN			
	9,525	3,175	0,001	R166ZZ	1	NTN			
	12,700	3,967	0,80	R166	1	NTN			
	12,700	4,978	2,20	R3	1	NTN			
	12,700	4,978	0,003	RA3LL	1	NTN			

d	D	B	Kg	Reference					Brands
4,762	12,700	4,978	0,003	RA3ZZ	1				NTN
5,000	8,000	2,000	0,002	675	1				NTN
	8,000	2,000	0,000	F-675	1				NTN
	8,000	2,500	0,000	F-FLWA675ZZ	1				NTN
	8,000	2,500	0,000	FLWA675ZZ	1				NTN
	8,000	2,500	0,000	F-WA675ZZ	1				NTN
	9,000	2,500	0,55	BC5-9	1				NTN
	9,000	2,500	0,001	F-B-9	1				NTN
	9,000	3,000	0,001	F-FLWB-9ZZ	1				NTN
	9,000	3,000	0,001	F-WB-9ZZ	1				NTN
	10,000	3,000	0,88	BC5-10	1				NTN
	10,000	3,000	0,001	F-FLB-10	1				NTN
	10,000	3,000	0,001	FLB-10	1				NTN
	11,000	3,000	0,001	685	1				NTN
	11,000	3,000	0,001	F-685	1				NTN
	11,000	4,000	0,002	F-FLWB-11ZZ	1				NTN
	11,000	4,000	0,002	F-WB-11ZZ	1				NTN
	11,000	4,000	0,002	WB-11ZZ	1				NTN
	11,000	4,000	2,00	WBC5-11Z	1				NTN
	11,000	5,000	0,002	F-FLW685ZZ	1				NTN
	11,000	5,000	0,002	F-W685Z1	1				NTN
	11,000	5,000	0,002	F-W685ZZ	1				NTN
	11,000	5,000	0,002	W685ZZ	1				NTN
	13,000	4,000	0,002	695	1				NTN
	13,000	4,000	0,002	695A	1				NTN
	13,000	4,000	0,002	695AZZ	1				NTN
	13,000	4,000	0,002	F-695AZZ	1				NTN
	13,000	4,000	0,003	F-FL695ZZ	1				NTN
	13,000	5,000	0,003	F-WB-13ZZ	1				NTN
	14,000	5,000	0,004	605	1				NTN
	14,000	5,000	0,003	605Z	1				NTN
	14,000	5,000	0,003	605ZZ	1				NTN
	14,000	5,000	0,003	F-605ZZ	1				NTN
14,000	5,000	0,004	F-FL605ZZ	1				NTN	
15,000	5,000	0,004	FLWB-13ZZ	1				NTN	
16,000	5,000	0,004	625	1				NTN-SNR	
16,000	5,000	0,01	625EE	1				SNR	
16,000	5,000	0,005	625LLB	1				NTN	
16,000	5,000	0,005	625LLU	1				NTN	
16,000	5,000	0,005	625Z	1				NTN-SNR	
16,000	5,000	0,005	625ZZ	1				NTN-SNR	
16,000	5,000	0,005	F-625ZZ	1				NTN	
16,000	5,000	0,004	FL605ZZ	1				NTN	
18,000	5,000	0,01	FL625ZZ	1				NTN	
19,000	6,000	0,01	635	1				NTN	
19,000	6,000	0,01	635LLB	1				NTN	
19,000	6,000	0,01	635LLU	1				NTN	
19,000	6,000	0,01	635ZZ	1				NTN-SNR	
20,000	9,500	0,02	F-DF501ZZ	1				NTN	
20,000	9,500	0,016	F-DF501ZZ1XCS12PX2/LX57Q1	5				NTN	
6,000	10,000	2,500	0,65	676A	1				NTN
	10,000	2,500	0,001	F-676	1				NTN
	10,000	3,000	0,001	F-FLWA676AZZ	1				NTN
	10,000	3,000	0,001	FLWA676ZZ	1				NTN
	10,000	3,000	0,001	F-WA676AZZ	1				NTN
	10,000	3,000	0,001	F-WA676ZZ	1				NTN
	10,000	3,000	0,001	WA676AZZ	1				NTN
	10,000	3,000	0,001	WA676ZZ	1				NTN
	12,000	3,000	1,30	BC6-12	1				NTN
	12,000	3,000	0,001	F-BC6-12	1				NTN

d	D	B	Kg	Reference					Brands
6,000	12,000	3,000	0,001	F-FLBC6-12	1				NTN
	12,000	4,000	0,002	F-FLAWBC6-12ZZ	1				NTN
	12,000	4,000	0,002	FLAWBC6-12ZZ	1				NTN
	12,000	4,000	0,002	F-WBC6-12LL	1				NTN
	12,000	4,000	0,002	F-WBC6-12ZZ	1				NTN
	12,000	4,000	0,002	WBC6-12ZZ	1				NTN
	13,000	3,500	0,002	686	1				NTN
	13,000	3,500	0,002	F-686	1				NTN
	13,000	3,500	0,002	F-FL686	1				NTN
	13,000	5,000	0,003	F-FLW686ZZ	1				NTN
	13,000	5,000	0,003	F-W686LL	1				NTN
	13,000	5,000	0,002	F-W686ZZ	1				NTN
	13,000	5,000	0,003	SC6A22ZZ	1				NTN
	13,000	5,000	0,003	SC6A30ZZ	1				NTN
	13,000	5,000	0,003	W686ZZ	1				NTN
	15,000	5,000	0,004	696	1				NTN
	15,000	5,000	0,004	696LLU	1				NTN
	15,000	5,000	0,003	696ZZ	1				NTN
	15,000	5,000	0,004	696ZZA	1				NTN
	15,000	5,000	0,004	F-696	1				NTN
	15,000	5,000	0,004	F-696ZZ	1				NTN
	15,000	5,000	0,004	F-FL696ZZ	1				NTN
	15,000	5,000	0,004	SC6A17ZZ	1				NTN
	15,000	5,000	0,004	SC6A17ZZN	1-NR				NTN
	16,000	6,000	0,01	BC6-16A	1				NTN
	16,000	6,000	0,01	BC6-16AZZ	1				NTN
	16,000	6,000	0,005	SX6A61LBLU	2				NTN
	16,000	6,000	0,005	SX6A61LUZ	2				NTN
	17,000	6,000	0,01	606	1				NTN
	17,000	6,000	0,01	606LLH	1				NTN
	17,000	6,000	0,01	606Z	1				NTN
	17,000	6,000	0,01	606ZZ	1				NTN
	17,000	6,000	0,01	F-606ZZ	1				NTN
	17,000	6,000	0,01	F-FL606ZZ	1				NTN
	17,000	6,000	0,01	FL606ZZ	1				NTN
	17,000	10,000	0,004	SX6A17ZZ	2				NTN
	19,000	6,000	0,01	626	1				NTN-SNR
	19,000	6,000	0,01	626EE	1				SNR
	19,000	6,000	0,01	626LLB	1				NTN
	19,000	6,000	0,01	626LLU	1				NTN
	19,000	6,000	0,01	626Z	1				NTN-SNR
19,000	6,000	0,01	626ZZ	1				NTN-SNR	
19,000	6,000	0,01	F-SC6A21	1				NTN	
19,000	6,000	0,08	SF612	2				NTN	
19,000	12,000	0,02	SF612DT	2				NTN	
19,000	12,000	0,02	SF624DF	2				NTN	
6,350	9,525	3,175	2,40	RA3	1				NTN
	12,700	3,175	0,60	R168A	1				NTN
	12,700	4,762	0,002	RA188ZZ	1				NTN
	13,894	4,762	0,003	FLRA188ZZA	1				NTN
	15,875	4,978	1,60	R188	1				NTN
	15,875	4,978	0,004	R4	1				NTN
	15,875	4,978	0,004	R4LL	1				NTN
	15,875	4,978	0,004	R4LLB	1				NTN
	15,875	4,978	0,004	R4ZZ	1				NTN
	7,000	11,000	2,500	0,003	677	1			
11,000	3,000	0,001	F-677	1				NTN	
11,000	3,000	0,001	F-WA677ZZ	1				NTN	
11,000	3,000	0,001	WA677ZZ	1				NTN	
13,000	3,000	1,40	BC7-13	1				NTN	

								Brands	
d	D	B	Kg	Reference					
7,000	13,000	3,000	0,001	F-BC7-13	1	NTN			
	13,000	4,000	0,002	F-FLAWBC7-13ZZ	1	NTN			
	13,000	4,000	0,002	F-WBC7-13ZZ	1	NTN			
	14,000	3,500	2,10	687A	1	NTN			
	14,000	3,500	0,002	F-687	1	NTN			
	14,000	5,000	0,003	F-W687AZZ	1	NTN			
	14,000	5,000	0,003	W687AZZ	1	NTN			
	16,000	5,000	0,004	F-FLW687AZZ	1	NTN			
	16,000	8,900	0,01	SX753Z1	2	NTN			
	17,000	4,000	0,004	SC731ZZ	1	NTN			
	17,000	5,000	0,01	697	1	NTN			
	17,000	5,000	0,01	697LLU	1	NTN			
	17,000	5,000	0,01	697Z	1	NTN			
	17,000	5,000	0,01	697ZZ	1	NTN			
	17,000	5,000	0,005	F-697	1	NTN			
	17,000	5,000	0,005	F-697LLU	1	NTN			
	17,000	5,000	0,01	F-FL697ZZ	1	NTN			
	19,000	6,000	0,01	607	1	NTN-SNR			
	19,000	6,000	0,01	607EE	1	SNR			
	19,000	6,000	0,01	607LB	1	NTN			
	19,000	6,000	0,01	607LLB	1	NTN			
	19,000	6,000	0,01	607LLU	1	NTN			
	19,000	6,000	0,01	607Z	1	NTN-SNR			
	19,000	6,000	0,01	607ZZ	1	NTN-SNR			
	19,000	6,000	0,01	SF703G	2	NTN			
	19,000	12,000	0,02	607ZZD2	1	NTN			
	22,000	7,000	0,01	627	1	NTN-SNR			
22,000	7,000	0,02	627EE	1	SNR				
22,000	7,000	0,01	627LLB	1	NTN				
22,000	7,000	0,01	627LLU	1	NTN				
22,000	7,000	0,01	627Z	1	NTN-SNR				
22,000	7,000	0,01	627ZZ	1	NTN-SNR				
22,000	10,319	0,02	WC87037	1	NTN				
8,000	12,000	2,500	0,75	678A	1	NTN			
	12,000	2,500	0,001	F-678	1	NTN			
	12,000	3,500	0,001	F-FLAW678AZZ	1	NTN			
	12,000	3,500	0,001	FLAW678AZZ	1	NTN			
	12,000	3,500	0,001	F-W678AZZ	1	NTN			
	12,000	3,500	0,001	W678AZZ	1	NTN			
	14,000	3,500	1,80	BC8-14	1	NTN			
	14,000	3,500	0,002	F-BC8-14	1	NTN			
	14,000	4,000	0,002	F-FLWBC8-14LL	1	NTN			
	14,000	4,000	0,002	F-FLWBC8-14ZZ	1	NTN			
	14,000	4,000	0,002	FLWBC8-14ZZ	1	NTN			
	14,000	4,000	0,002	F-WBC8-14LL	1	NTN			
	14,000	4,000	0,002	F-WBC8-14ZZ	1	NTN			
	14,000	4,000	0,002	WBC8-14LL	1	NTN			
	14,000	4,000	0,002	WBC8-14ZZ	1	NTN			
	16,000	4,000	3,10	688A	1	NTN			
	16,000	4,000	0,003	F-688	1	NTN			
	16,000	4,000	0,004	F-FL688	1	NTN			
	16,000	5,000	0,004	F-FLW688AZ	1	NTN			
	16,000	5,000	0,004	F-FLW688AZZ	1	NTN			
	16,000	5,000	0,004	FLW688ALLU	1	NTN			
	16,000	5,000	0,004	F-W688ALLU	1	NTN			
	16,000	5,000	0,004	F-W688AZZ	1	NTN			
	16,000	5,000	0,004	SC866ZZ	1	NTN			
	16,000	5,000	0,004	SC890ZZ	1	NTN			
	16,000	5,000	0,003	W688ALB	1	NTN			
	16,000	5,000	0,003	W688ALLU	1	NTN			
16,000	5,000	0,004	W688AZ	1	NTN				

								Brands	
d	D	B	Kg	Reference					
8,000	16,000	5,000	0,004	W688AZZ	1	NTN			
	19,000	6,000	0,01	698	1	NTN			
	19,000	6,000	0,01	698LLB	1	NTN			
	19,000	6,000	0,01	698LLU	1	NTN			
	19,000	6,000	0,01	698ZZ	1	NTN			
	19,000	6,000	0,01	F-698LLU	1	NTN			
	19,000	6,000	0,01	F-698ZZ	1	NTN			
	19,000	6,000	0,01	F-FL698ZZ	1	NTN			
	19,000	6,000	0,01	FL698LLB	1	NTN			
	19,000	6,000	0,01	FL698Z	1	NTN			
	19,000	6,000	0,01	FL698ZZ	1	NTN			
	19,000	6,000	0,01	SC8A91ZZ	1	NTN			
	19,000	6,000	0,01	SC8A91ZZM	1	NTN			
	19,000	12,000	0,01	698ZZD2	1	NTN			
	22,000	6,000	0,01	F-SX8A72LL	1	NTN			
	22,000	7,000	0,01	608	1	NTN-SNR			
	22,000	7,000	0,01	608EE	1	SNR			
	22,000	7,000	0,02	608FT150	1	SNR			
	22,000	7,000	0,01	608LB	1	NTN			
	22,000	7,000	0,01	608LLB	1	NTN			
	22,000	7,000	0,01	608LLH	1	NTN			
	22,000	7,000	0,01	608LLU	1	NTN			
	22,000	7,000	0,01	608LU	1	NTN			
	22,000	7,000	0,01	608Z	1	NTN-SNR			
	22,000	7,000	0,01	608ZZ	1	NTN-SNR			
	22,000	7,000	0,01	F-608J1LLU	1	NTN			
	22,000	7,000	0,01	F-608LLU	1	NTN			
	22,000	7,000	0,01	SC850LLB	1	NTN			
	22,000	7,000	0,01	SC850LLBM	1	NTN			
	22,000	7,000	0,01	SC850ZZ	1	NTN			
	22,000	7,000	0,01	SC858ZZ	1	NTN			
	22,000	7,000	0,01	SC8A18ZZ	1	NTN			
	22,000	7,000	0,01	SC8A58ZZ	1	NTN			
22,000	7,000	0,01	SC8A58ZZM	1	NTN				
22,000	7,000	0,01	SF802	2	NTN				
22,000	10,000	0,02	SC811LLU	1	NTN				
22,000	14,000	0,02	SF802DB	2	NTN				
22,000	14,000	0,02	SF821DT	2	NTN				
22,000	21,000	0,04	SF821DTT	2	NTN				
24,000	8,000	0,02	628LLB	1	NTN				
24,000	8,000	0,02	628LLH	1	NTN				
24,000	8,000	0,02	628LLU	1	NTN				
24,000	8,000	0,02	628Z	1	NTN				
24,000	8,000	0,02	628ZZ	1	NTN				
24,000	10,319	0,02	87008	1	NTN				
26,250	4,800	0,02	SC8B07ZZ	1	NTN				
28,000	9,000	0,03	638Z	1	NTN				
28,000	9,000	0,03	638ZZ	1	NTN				
9,000	13,000	3,000	0,001	F-679	1	NTN			
	14,000	3,000	0,004	679	1	NTN			
	14,000	4,500	0,002	F-W679ZZ	1	NTN			
	16,000	3,000	2,36	679/16	1	NTN			
	17,000	4,000	0,003	689	1	NTN			
	17,000	4,000	0,003	F-689	1	NTN			
	17,000	5,000	0,004	F-FLW689ZZ	1	NTN			
	17,000	5,000	0,004	F-W689Z1	1	NTN			
	17,000	5,000	0,004	F-W689ZZ	1	NTN			
	17,000	5,000	0,004	W689ZZ	1	NTN			
	17,000	5,000	0,004	W689ZZS	1	NTN			
	20,000	6,000	0,01	699	1	NTN			
	20,000	6,000	0,01	699BZZ	1	NTN			



d	D	B	Kg	Reference		Brands
9,000	20,000	6,000	0,01	699Z	1	NTN
	20,000	6,000	0,01	699ZZ	1	NTN
	20,000	6,000	0,01	F-699LLU	1	NTN
	20,000	6,000	0,01	F-699ZZ	1	NTN
	20,000	6,000	0,01	F-699ZZ/22	1	NTN
	24,000	7,000	0,01	609	1	NTN-SNR
	24,000	7,000	0,02	609EE	1	SNR
	24,000	7,000	0,01	609J	1	NTN
	24,000	7,000	0,02	609JLLB	1	NTN
	24,000	7,000	0,01	609JX2	1	NTN
	24,000	7,000	0,02	609JX2LLU	1	NTN
	24,000	7,000	0,01	609JX2LUZ	1	NTN
	24,000	7,000	0,01	609JX2Z	1	NTN
	24,000	7,000	0,02	609LLU	1	NTN
	24,000	7,000	0,02	609Z	1	SNR
	24,000	7,000	0,02	609ZZ	1	SNR
	24,000	7,000	0,02	SC929ZZ	1	NTN
	24,000	7,000	0,02	SC929ZZ1	1	NTN
	26,000	8,000	0,02	629	1	SNR
	26,000	8,000	0,02	629EE	1	SNR
	26,000	8,000	20,00	629X50	1	NTN
	26,000	8,000	0,02	629X50LLB	1	NTN
	26,000	8,000	0,02	629X50LLU	1	NTN
	26,000	8,000	0,02	629X50Z	1	NTN
	26,000	8,000	0,02	629X50ZZ	1	NTN
	26,000	8,000	0,02	629ZZ	1	SNR
9,525	22,220	7,140	0,01	R6LLB	1	NTN
	22,220	7,140	0,01	R6LLU	1	NTN
	22,220	7,140	0,01	R6Z	1	NTN
	22,225	5,556	0,01	SF0011	2	NTN
	22,225	7,142	0,01	F-R6	1	NTN
	22,225	7,142	0,01	F-R6ZZ	1	NTN
	22,225	7,142	0,01	R6ZZ	1	NTN
	10,000	15,000	3,000	0,001	6700	1
15,000		4,000	0,002	SC0077ZZA	1	NTN
15,000		4,000	0,002	W6700LLF	1	NTN
19,000		5,000	0,01	6800	1	NTN
19,000		5,000	0,01	6800LLB	1	NTN
19,000		5,000	0,01	6800LLU	1	NTN
19,000		5,000	0,01	6800LUZ	1	NTN
19,000		5,000	0,01	6800Z	1	NTN
19,000		5,000	0,01	6800ZZ	1	NTN
22,000		6,000	0,01	6900	1	NTN
22,000		6,000	0,01	6900LLB	1	NTN
22,000		6,000	0,01	6900LLU	1	NTN
22,000		6,000	0,01	6900LLUNR	1-NR	NTN
22,000		6,000	0,01	6900NR	1-NR	NTN
22,000		6,000	0,01	6900Z	1	NTN
22,000		6,000	0,01	6900ZZ	1	NTN
22,000		6,000	0,01	6900ZZN	1-NR	NTN
22,000		6,000	0,01	6900ZZNR	1-NR	NTN
24,000		9,000	0,02	51100	34	NTN-SNR
26,000		8,000	0,02	6000	1	NTN-SNR
26,000		8,000	0,02	6000E	1	SNR
26,000		8,000	0,01	6000EE	1	SNR
26,000		8,000	0,02	6000FT150	1	SNR
26,000		8,000	0,02	6000FT150ZZ	1	SNR
26,000		8,000	0,02	6000HVZZ	1	SNR
26,000		8,000	0,02	6000J	1	NTN
26,000		8,000	0,02	6000JLLB	1	NTN

d	D	B	Kg	Reference		Brands
10,000	26,000	8,000	0,02	6000JX2LLH	1	NTN
	26,000	8,000	0,02	6000LB	1	NTN
	26,000	8,000	0,02	6000LLB	1	NTN
	26,000	8,000	0,02	6000LLH	1	NTN
	26,000	8,000	0,02	6000LLU	1	NTN
	26,000	8,000	0,11	6000LT	1	SNR
	26,000	8,000	0,11	6000LTZZ	1	SNR
	26,000	8,000	0,02	6000LU	1	NTN
	26,000	8,000	0,02	6000Z	1	NTN-SNR
	26,000	8,000	0,02	6000ZZ	1	NTN-SNR
	26,000	8,000	0,02	6000ZZG15	1	SNR
	26,000	8,000	0,02	7000	2	NTN
	26,000	8,000	0,02	F-6000J1LLU	1	NTN
	26,000	8,000	0,02	S60002RS	1	SNR
	26,000	8,000	0,02	SC0039ZZ	1	NTN
	26,000	8,000	0,02	SC0046ZZ	1	NTN
	26,000	8,000	0,02	SC0061ZZ	1	NTN
	26,000	8,000	0,02	SC00A18ZZ	1	NTN
	26,000	8,000	0,02	SSN000LL	1	NTN
	26,000	10,000	0,03	51200	34	NTN
	26,000	10,000	0,03	51200J	34	NTN
	26,000	12,000	0,03	63000EE	1	SNR
	26,000	16,000	0,04	7000DB	2	NTN
	26,000	16,000	0,04	7000DF	2	NTN
	30,000	9,000	0,03	1200G15	6	SNR
	30,000	9,000	0,03	1200S	6	NTN
	30,000	9,000	0,03	6200	1	NTN-SNR
	30,000	9,000	0,03	6200EE	1	SNR
	30,000	9,000	0,03	6200FT150	1	SNR
	30,000	9,000	0,03	6200FT150ZZ	1	SNR
	30,000	9,000	0,03	6200LB	1	NTN
	30,000	9,000	0,03	6200LLB	1	NTN
	30,000	9,000	0,03	6200LLBNR	1-NR	NTN
	30,000	9,000	0,03	6200LLH	1	NTN
	30,000	9,000	0,03	6200LLU	1	NTN
	30,000	9,000	0,03	6200LLUNR	1-NR	NTN
	30,000	9,000	0,05	6200LT	1	SNR
	30,000	9,000	0,04	6200LTZZ	1	SNR
	30,000	9,000	0,03	6200LU	1	NTN
	30,000	9,000	0,04	6200NRZZ	1-NR	SNR
	30,000	9,000	0,03	6200Z	1	NTN-SNR
	30,000	9,000	0,03	6200ZNR	1-NR	NTN
	30,000	9,000	0,03	6200ZZ	1	NTN-SNR
	30,000	9,000	0,03	6200ZZNR	1-NR	NTN
	30,000	9,000	0,03	7200	2	NTN
	30,000	9,000	0,03	7200B	2	NTN
	30,000	9,000	0,03	7200BG	2	NTN
30,000	9,000	0,03	CS200LLU	12	NTN	
30,000	9,000	0,03	S62002RS	1	SNR	
30,000	9,000	0,03	SSN200LL	1	NTN	
30,000	12,700	0,03	87500	1	NTN	
30,000	12,700	0,04	WC87500	1	NTN	
30,000	14,000	0,05	2200G14	6	SNR	
30,000	14,000	0,04	2200S	6	NTN	
30,000	14,000	0,05	3200A	5	SNR	
30,000	14,000	0,06	4200A	4	SNR	
30,000	14,000	0,05	62200EE	1	SNR	
30,000	14,000	0,05	62200ZZ	1	SNR	
30,000	14,300	0,05	5200S	5	NTN	
30,000	14,300	0,05	5200SCLLD	5	NTN	
30,000	14,300	0,05	5200SCLLM	5	NTN	
30,000	14,300	0,05	5200SCZZ	5	NTN	

								Brands		
d	D	B	Kg	Reference						
10,000	30,000	16,401	0,05	88500	1	NTN				
	30,000	18,000	0,06	7200DB	2	NTN				
	30,000	18,000	0,06	7200DF	2	NTN				
	32,000	8,000	0,04	SX0011LL	2	NTN				
	32,836	6,000	0,01	SX0087ZZ	2	NTN				
	35,000	11,000	0,06	1300S	6	NTN				
	35,000	11,000	0,05	6300	1	NTN-SNR				
	35,000	11,000	0,06	6300EE	1	SNR				
	35,000	11,000	0,05	6300FT150ZZ	1	SNR				
	35,000	11,000	0,05	6300LLB	1	NTN				
	35,000	11,000	0,05	6300LLU	1	NTN				
	35,000	11,000	0,05	6300LU	1	NTN				
	35,000	11,000	0,05	6300Z	1	NTN				
	35,000	11,000	0,05	6300ZZ	1	NTN-SNR				
	35,000	11,000	0,05	6300ZZNR	1-NR	NTN				
	35,000	11,000	0,05	7300	2	NTN				
	35,000	11,000	0,06	7300B	2	NTN				
	35,000	11,000	0,05	7300BG	2	NTN				
	35,000	11,000	0,05	S63002RS	1	SNR				
	35,000	17,000	0,08	2300S	6	NTN				
	35,000	17,000	0,08	62300EE	1	SNR				
	35,000	22,000	0,11	7300BDB	2	NTN				
	35,000	22,000	0,11	7300BDF	2	NTN				
	35,000	22,000	0,11	7300DB	2	NTN				
	11,000	16,000	4,000	0,002	SC01A21	1	NTN			
	12,000	18,000	4,000	0,002	6701	1	NTN			
		18,000	4,000	0,003	6701LLF	1	NTN			
		18,000	4,000	0,003	6701ZZ	1	NTN			
		21,000	5,000	0,01	6801	1	NTN			
		21,000	5,000	0,01	6801LBLU	1	NTN			
21,000		5,000	0,01	6801LLB	1	NTN				
21,000		5,000	0,01	6801LLU	1	NTN				
21,000		5,000	0,01	6801Z	1	NTN				
21,000		5,000	0,01	6801ZZ	1	NTN				
21,000		5,000	0,01	SC01A36ZZ	1	NTN				
24,000		6,000	0,01	6901	1	NTN				
24,000		6,000	0,01	6901LLB	1	NTN				
24,000		6,000	0,01	6901LLU	1	NTN				
24,000		6,000	0,01	6901LLUN	1-NR	NTN				
24,000		6,000	0,01	6901LLUNR	1-NR	NTN				
24,000		6,000	0,01	6901LU	1	NTN				
24,000		6,000	0,01	6901N	1-NR	NTN				
24,000		6,000	0,01	6901NR	1-NR	NTN				
24,000		6,000	0,01	6901Z	1	NTN				
24,000		6,000	0,01	6901ZZ	1	NTN				
24,000		6,000	0,01	6901ZZNR	1-NR	NTN				
24,000		6,000	0,01	SSN901LL	1	NTN				
26,000		9,000	0,02	51101	34	NTN-SNR				
28,000		7,000	0,02	16001	1	NTN				
28,000		8,000	0,02	6001	1	NTN-SNR				
28,000		8,000	0,02	6001E	1	SNR				
28,000		8,000	0,02	6001EE	1	SNR				
28,000		8,000	0,02	6001F579	1	SNR				
28,000		8,000	0,03	6001FT150	1	SNR				
28,000		8,000	0,02	6001FT150ZZ	1	SNR				
28,000		8,000	0,02	6001G15	1	SNR				
28,000		8,000	0,02	6001HVZZ	1	SNR				
28,000		8,000	0,02	6001LB	1	NTN				
28,000		8,000	0,02	6001LH	1	NTN				
28,000		8,000	0,02	6001LLB	1	NTN				

								Brands	
d	D	B	Kg	Reference					
12,000	28,000	8,000	0,02	6001LLH	1	NTN			
	28,000	8,000	0,02	6001LLU	1	NTN			
	28,000	8,000	0,02	6001LT	1	SNR			
	28,000	8,000	0,03	6001LTZZ	1	SNR			
	28,000	8,000	0,02	6001LU	1	NTN			
	28,000	8,000	0,02	6001Z	1	NTN-SNR			
	28,000	8,000	0,02	6001ZZ	1	NTN-SNR			
	28,000	8,000	0,02	7001	2	NTN			
	28,000	8,000	0,02	F-6001J1LLU	1	NTN			
	28,000	8,000	0,02	F-6001J1ZZ	1	NTN			
	28,000	8,000	0,02	S60012RS	1	SNR			
	28,000	8,000	0,02	SF0161Z	2	NTN			
	28,000	8,000	0,02	SSN001LL	1	NTN			
	28,000	8,000	0,02	SSN001ZZ	1	NTN			
	28,000	11,000	0,03	51201	34	NTN			
	28,000	11,000	0,03	51201J	34	NTN			
	28,000	12,000	0,03	63001EE	1	SNR			
	28,000	16,000	0,04	6001ZZD2	1	NTN			
	28,000	16,000	0,04	7001DB	2	NTN			
	28,000	16,000	0,04	7001DF	2	NTN			
	28,000	16,000	0,05	7001DT	2	NTN			
	30,000	8,000	0,03	16101	1	NTN			
	32,000	10,000	0,05	1201G15	6	SNR			
	32,000	10,000	0,04	1201S	6	NTN			
	32,000	10,000	0,04	6201	1	NTN-SNR			
	32,000	10,000	0,04	6201E	1	SNR			
	32,000	10,000	0,04	6201EE	1	SNR			
	32,000	10,000	0,04	6201FT150	1	SNR			
	32,000	10,000	0,04	6201FT150ZZ	1	SNR			
	32,000	10,000	0,04	6201HT200ZZ	1	SNR			
	32,000	10,000	0,04	6201HVZZ	1	SNR			
	32,000	10,000	0,04	6201LB	1	NTN			
	32,000	10,000	0,04	6201LLB	1	NTN			
	32,000	10,000	0,04	6201LLBNR	1-NR	NTN			
	32,000	10,000	0,04	6201LLH	1	NTN			
	32,000	10,000	0,04	6201LLHN	1-NR	NTN			
	32,000	10,000	0,04	6201LLHNR	1-NR	NTN			
	32,000	10,000	0,04	6201LLU	1	NTN			
	32,000	10,000	0,04	6201LLUNR	1-NR	NTN			
	32,000	10,000	0,04	6201LT	1	SNR			
	32,000	10,000	0,04	6201LTZZ	1	SNR			
	32,000	10,000	0,04	6201LU	1	NTN			
	32,000	10,000	0,04	6201NR	1-NR	NTN			
	32,000	10,000	0,04	6201NRZZ	1-NR	SNR			
	32,000	10,000	0,04	6201Z	1	NTN-SNR			
	32,000	10,000	0,04	6201ZNR	1-NR	NTN			
	32,000	10,000	0,04	6201ZZ	1	NTN-SNR			
	32,000	10,000	0,04	6201ZZN	1-NR	NTN			
	32,000	10,000	0,04	6201ZZNR	1-NR	NTN			
	32,000	10,000	0,04	7201	2	NTN			
32,000	10,000	0,04	7201B	2	NTN				
32,000	10,000	0,04	7201BG	2	NTN				
32,000	10,000	0,04	CS201LLU	12	NTN				
32,000	10,000	0,03	S62012RS	1	SNR				
32,000	10,000	0,04	SF0164LLB	2	NTN				
32,000	10,000	0,04	SSN201LL	1	NTN				
32,000	12,700	0,05	87501	1	NTN				
32,000	14,000	0,06	2201EEG15	6	SNR				
32,000	14,000	0,05	2201G15	6	SNR				
32,000	14,000	0,05	2201S	6	NTN				
32,000	14,000	0,06	4201A	4	SNR				
32,000	14,000	0,05	62201EE	1	SNR				

										Brands		
d	D	B	Kg	Reference								
12,000	32,000	14,000	0,05	62201LLU	1	NTN						
	32,000	15,400	0,04	88501	1	NTN						
	32,000	15,900	0,06	3201A	5	SNR						
	32,000	15,900	0,06	5201EEG15	5	SNR						
	32,000	15,900	0,06	5201S	5	NTN						
	32,000	15,900	0,06	5201SCLLD	5	NTN						
	32,000	15,900	0,06	5201SCLLM	5	NTN						
	32,000	15,900	0,06	5201SCZZ	5	NTN						
	32,000	15,900	0,06	5201ZZG15	5	SNR						
	32,000	20,000	0,07	6201LLBD2	1	NTN						
	32,000	20,000	0,08	7201BDB	2	NTN						
	32,000	20,000	0,07	7201DB	2	NTN						
	32,000	20,000	0,07	7201DT	2	NTN						
	37,000	12,000	0,07	1301G14	6	SNR						
	37,000	12,000	0,07	1301S	6	NTN						
	37,000	12,000	0,06	6301	1	NTN-SNR						
	37,000	12,000	0,07	6301EE	1	SNR						
	37,000	12,000	0,06	6301FT150ZZ	1	SNR						
	37,000	12,000	0,06	6301LLB	1	NTN						
	37,000	12,000	0,06	6301LLH	1	NTN						
	37,000	12,000	0,06	6301LLU	1	NTN						
	37,000	12,000	0,06	6301LLUNR	1-NR	NTN						
	37,000	12,000	0,06	6301LU	1	NTN						
	37,000	12,000	0,06	6301Z	1	NTN-SNR						
	37,000	12,000	0,06	6301ZZ	1	NTN-SNR						
	37,000	12,000	0,06	6301ZZNR	1-NR	NTN						
	37,000	12,000	0,04	7301	2	NTN						
	37,000	12,000	0,06	7301B	2	NTN						
	37,000	12,000	0,06	S63012RS	1	SNR						
	37,000	17,000	0,08	2301S	6	NTN						
	37,000	17,000	0,07	62301EE	1	SNR						
	37,000	24,000	0,12	7301BDB	2	NTN						
	37,000	24,000	0,12	7301BDF	2	NTN						
	40,000	22/12	0,10	AS201D1	10	NTN						
	40,000	22/12	0,12	ASS201N	15	NTN						
	40,000	22/12	0,09	US201G2	10	SNR						
	40,000	28,6/19	0,12	AEL201D1	11	NTN						
	40,000	28,6/19	0,12	AELS201N	16	NTN						
	40,000	28,6/19,1	0,14	ES201G2	11	SNR						
	42,000	10,000	0,03	SX0197ZZ	2	NTN						
	42,000	13,000	0,09	SF0165ZZ	2	NTN						
	47,000	31/16	0,21	UC201G2	7	SNR						
	47,000	31/17	0,21	UC201D1	7	NTN						
	47,000	31/17	0,21	UCS201LD1N	13	NTN						
	47,000	43,5/34	0,29	EX201G2	8	SNR						
	12,700	32,000	10,000	0,04	6201LLB/127	1	NTN					
		38,100	11,100	0,07	SX01A34ZZ	2	NTN					
38,200		15,900	0,097	DF0109LLPX1/L627U0JD	5	NTN						
38,200		15,900	0,097	DF0109LLPX1/L657	5	NTN						
38,200		15,900	0,097	DF0109LLPX1/L738	5	NTN						
12,705	38,092	11,112	0,06	SX01A28LLBA1	2	NTN						
13,000	28,000	6,350	0,02	SC01A38	1	NTN						
	31,000	13,000	0,04	SX01A32	2	NTN						
	32,000	7,000	0,03	SC01A33	1	NTN						
	32,000	12,700	0,04	87013	1	NTN						
	32,000	12,700	0,04	WC87013	1	NTN						
14,000	25,400	6,000	0,01	SC02A55	1	NTN						

										Brands	
d	D	B	Kg	Reference							
15,000	21,000	4,000	0,003	6702	1	NTN					
	21,000	4,000	0,003	6702LLF	1	NTN					
	24,000	5,000	0,01	6802	1	NTN					
	24,000	5,000	0,01	6802LLB	1	NTN					
	24,000	5,000	0,01	6802LLU	1	NTN					
	24,000	5,000	0,01	6802Z	1	NTN					
	24,000	5,000	0,01	6802ZZ	1	NTN					
	24,000	5,000	0,01	SSN802ZZ	1	NTN					
	28,000	7,000	0,02	6902	1	NTN					
	28,000	7,000	0,02	6902LLB	1	NTN					
	28,000	7,000	0,02	6902LLH	1	NTN					
	28,000	7,000	0,02	6902LLU	1	NTN					
	28,000	7,000	0,02	6902LLUNR	1-NR	NTN					
	28,000	7,000	0,02	6902LU	1	NTN					
	28,000	7,000	0,02	6902NR	1-NR	NTN					
	28,000	7,000	0,02	6902Z	1	NTN					
	28,000	7,000	0,02	6902ZZ	1	NTN					
	28,000	7,000	0,02	6902ZZNR	1-NR	NTN					
	28,000	7,000	0,02	F-6902J1LLU	1	NTN					
	28,000	7,000	0,02	SSN902LL	1	NTN					
	28,000	9,000	0,02	51102	34	NTN-SNR					
	32,000	8,000	0,03	16002	1	NTN-SNR					
	32,000	9,000	0,03	6002	1	NTN-SNR					
	32,000	9,000	0,03	6002E	1	SNR					
	32,000	9,000	0,03	6002EE	1	SNR					
	32,000	9,000	0,02	6002FT150	1	SNR					
	32,000	9,000	0,03	6002FT150ZZ	1	SNR					
	32,000	9,000	0,03	6002HVZZ	1	SNR					
	32,000	9,000	0,03	6002LB	1	NTN					
	32,000	9,000	0,03	6002LLB	1	NTN					
	32,000	9,000	0,03	6002LLBNR	1-NR	NTN					
	32,000	9,000	0,03	6002LLU	1	NTN					
	32,000	9,000	0,03	6002LLUN	1-NR	NTN					
	32,000	9,000	0,03	6002LLUNR	1-NR	NTN					
	32,000	9,000	0,03	6002LT	1	SNR					
	32,000	9,000	0,03	6002LTZZ	1	SNR					
	32,000	9,000	0,03	6002LU	1	NTN					
	32,000	9,000	0,03	6002N	1-NR	SNR					
	32,000	9,000	0,03	6002NZZ	1-NR	SNR					
	32,000	9,000	0,03	6002Z	1	NTN-SNR					
	32,000	9,000	0,03	6002ZNR	1-NR	NTN					
	32,000	9,000	0,03	6002ZZ	1	NTN-SNR					
	32,000	9,000	0,03	6002ZZNR	1-NR	NTN					
	32,000	9,000	0,04	7002	2	NTN					
	32,000	9,000	0,03	S60022RS	1	SNR					
	32,000	9,000	0,03	SF0228	2	NTN					
	32,000	9,000	0,03	SSN002LL	1	NTN					
	32,000	9,000	0,03	SSN002ZZ	1	NTN					
	32,000	10,000	0,03	SC0289LLH	1	NTN					
	32,000	12,000	0,04	51202	34	NTN-SNR					
	32,000	13,000	0,05	63002EE	1	SNR					
32,000	15,900	0,054	DF0261C3/2AS	5	NTN						
32,000	18,000	0,09	7002DB	2	NTN						
32,000	18,000	0,09	7002DF	2	NTN						
32,000	18,000	0,09	7002DT	2	NTN						
35,000	8,500	0,04	SC0288	1	NTN						
35,000	8,500	0,04	SC02A17	1	NTN						
35,000	11,000	0,05	1202G15	6	SNR						
35,000	11,000	0,05	1202S	6	NTN						
35,000	11,000	0,04	6202	1	NTN-SNR						
35,000	11,000	0,05	6202E	1	SNR						
35,000	11,000	0,05	6202EE	1	SNR						

										Brands	
d	D	B	Kg	Reference							
15,000	35,000	11,000	0,05	6202FT150	1	SNR					
	35,000	11,000	0,05	6202FT150ZZ	1	SNR					
	35,000	11,000	0,05	6202HT200ZZ	1	SNR					
	35,000	11,000	0,05	6202HVZZ	1	SNR					
	35,000	11,000	0,04	6202LB	1	NTN					
	35,000	11,000	0,04	6202LLB	1	NTN					
	35,000	11,000	0,04	6202LLBNR	1-NR	NTN					
	35,000	11,000	0,04	6202LLH	1	NTN					
	35,000	11,000	0,04	6202LLU	1	NTN					
	35,000	11,000	0,05	6202LLUNR	1-NR	NTN					
	35,000	11,000	0,05	6202LT	1	SNR					
	35,000	11,000	0,05	6202LTZZ	1	SNR					
	35,000	11,000	0,04	6202LU	1	NTN					
	35,000	11,000	0,05	6202NR	1-NR	NTN-SNR					
	35,000	11,000	0,05	6202NREE	1-NR	SNR					
	35,000	11,000	0,05	6202NRZZ	1-NR	SNR					
	35,000	11,000	0,04	6202Z	1	NTN-SNR					
	35,000	11,000	0,05	6202ZG15B	1	SNR					
	35,000	11,000	0,05	6202ZNR	1-NR	NTN					
	35,000	11,000	0,04	6202ZZ	1	NTN-SNR					
	35,000	11,000	0,04	6202ZZG15	1	SNR					
	35,000	11,000	0,05	6202ZZNR	1-NR	NTN					
	35,000	11,000	0,04	7202	2	NTN					
	35,000	11,000	0,05	7202B	2	NTN					
	35,000	11,000	0,04	7202BA	2	SNR					
	35,000	11,000	0,05	7202BG	2	NTN					
	35,000	11,000	0,04	CS202LLU	12	NTN					
	35,000	11,000	0,05	S62022RS	1	SNR					
	35,000	11,000	0,04	SF02A12	2	NTN					
	35,000	11,000	0,04	SSN202LL	1	NTN					
	35,000	11,000	0,04	SSN202ZZ	1	NTN					
	35,000	12,700	0,04	8502	1	NTN					
	35,000	12,700	0,05	87502	1	NTN					
	35,000	12,700	0,05	WC87502	1	NTN					
	35,000	14,000	0,06	2202EEG15	6	SNR					
	35,000	14,000	0,06	2202G15	6	SNR					
	35,000	14,000	0,06	2202S	6	NTN					
	35,000	14,000	0,07	4202A	4	SNR					
	35,000	14,000	0,06	62202EE	1	SNR					
	35,000	14,400	0,05	88502	1	NTN					
	35,000	15,870	0,06	63202LLU	1	NTN					
	35,000	15,875	0,06	63202LLB	1	NTN					
	35,000	15,875	0,06	63202ZZ	1	NTN					
	35,000	15,900	0,07	3202A	5	SNR					
	35,000	15,900	0,07	5202EEG15	5	SNR					
	35,000	15,900	0,07	5202NRZZG15	5-NR	SNR					
	35,000	15,900	0,07	5202S	5	NTN					
	35,000	15,900	0,07	5202SCLLD	5	NTN					
	35,000	15,900	0,07	5202SCLLM	5	NTN					
	35,000	15,900	0,07	5202SCZZ	5	NTN					
35,000	15,900	0,07	5202ZZG15	5	SNR						
35,000	20,000	0,083	DF0213LLU/2AS	5	NTN						
35,000	20,000	0,083	DF0213LLU/L623	5	NTN						
35,000	20,000	0,086	DF0213LLUA/LX03Q3	5	NTN						
35,000	22,000	0,09	7202BDB	2	NTN						
35,000	22,000	0,09	7202DB	2	NTN						
35,000	22,000	0,09	7202DF	2	NTN						
36,700	9,000	0,03	6002NR	1-NR	NTN						
38,000	12,000	0,06	SC0299LUZ	1	NTN						
40,000	12,000	0,07	6203LLU/15	1	NTN						
40,000	22/12	0,09	AS202D1	10	NTN						
40,000	22/12	0,11	ASS202N	15	NTN						

										Brands	
d	D	B	Kg	Reference							
15,000	40,000	22/12	0,08	US202G2	10	SNR					
	40,000	28,6/19	0,11	AEL202D1	11	NTN					
	40,000	28,6/19	0,11	AELS202N	16	NTN					
	40,000	28,6/19,1	0,13	ES202G2	11	SNR					
	42,000	11,500	0,07	SC0284	1	NTN					
	42,000	13,000	0,10	1302G14	6	SNR					
	42,000	13,000	0,09	1302S	6	NTN					
	42,000	13,000	0,08	6302	1	NTN-SNR					
	42,000	13,000	0,09	6302E	1	SNR					
	42,000	13,000	0,09	6302EE	1	SNR					
	42,000	13,000	0,09	6302FT150ZZ	1	SNR					
	42,000	13,000	0,08	6302LB	1	NTN					
	42,000	13,000	0,08	6302LLB	1	NTN					
	42,000	13,000	0,08	6302LLBNR	1-NR	NTN					
	42,000	13,000	0,08	6302LLH	1	NTN					
	42,000	13,000	0,08	6302LLU	1	NTN					
	42,000	13,000	0,08	6302LLUNR	1-NR	NTN					
	42,000	13,000	0,08	6302LU	1	NTN					
	42,000	13,000	0,08	6302NR	1-NR	NTN					
	42,000	13,000	0,08	6302Z	1	NTN-SNR					
	42,000	13,000	0,08	6302ZNR	1-NR	NTN					
	42,000	13,000	0,08	6302ZZ	1	NTN-SNR					
	42,000	13,000	0,08	6302ZZN	1-NR	NTN					
	42,000	13,000	0,08	6302ZZNR	1-NR	NTN					
	42,000	13,000	0,08	7302	2	NTN					
	42,000	13,000	0,09	7302B	2	NTN					
	42,000	13,000	0,08	7302BG	2	NTN					
	42,000	17,000	0,11	2302G15	6	SNR					
	42,000	17,000	0,11	2302S	6	NTN					
	42,000	17,000	0,12	4302A	4	SNR					
	42,000	17,000	0,11	62302EE	1	SNR					
	42,000	19,000	0,13	3302A	5	SNR					
	42,000	19,000	0,13	5302EEG15	5	SNR					
	42,000	19,000	0,11	5302S	5	NTN					
	42,000	24,000	0,150	DF0282LLH1CS23/L417	5	NTN					
	42,000	26,000	0,17	7302BDB	2	NTN					
	42,000	26,000	0,11	7302BDF	2	NTN					
	42,000	26,000	0,17	7302DB	2	NTN					
	42,000	26,000	0,17	7302DF	2	NTN					
	47,000	31/16	0,20	UC202G2	7	SNR					
47,000	31/17	0,20	UC202D1	7	NTN						
47,000	31/17	0,20	UCS202LD1N	13	NTN						
47,000	43,5/34	0,27	EX202G2	8	SNR						
15,875	34,925	8,731	0,04	R10LLB	1	NTN					
	34,925	8,731	0,04	R10LLU	1	NTN					
	34,925	8,731	0,04	R10ZZ	1	NTN					
	35,000	11,000	0,04	6202LLU/15875	1	NTN					
40,000	12,000	0,07	6203LLU/15875	1	NTN						
16,000	35,000	8,000	0,03	16003/16	1	NTN					
	35,000	12,700	0,04	87016	1	NTN					
	35,000	12,700	0,05	WC87016	1	NTN					
	35,000	14,399	0,04	88016	1	NTN					
17,000	23,000	4,000	0,003	6703	1	NTN					
	23,000	4,000	0,004	6703LLF	1	NTN					
	26,000	5,000	0,01	6803	1	NTN					
	26,000	5,000	0,01	6803LB	1	NTN					
	26,000	5,000	0,01	6803LLB	1	NTN					
	26,000	5,000	0,01	6803LLU	1	NTN					
	26,000	5,000	0,01	6803Z	1	NTN					

								Brands	
d	D	B	Kg	Reference					
17,000	26,000	5,000	0,01	6803ZZ	1	NTN			
	30,000	7,000	0,01	6903	1	NTN			
	30,000	7,000	0,02	6903LLB	1	NTN			
	30,000	7,000	0,02	6903LLU	1	NTN			
	30,000	7,000	0,02	6903LLUNR	1-NR	NTN			
	30,000	7,000	0,02	6903Z	1	NTN			
	30,000	7,000	0,02	6903ZZ	1	NTN			
	30,000	7,000	0,02	6903ZZNR	1-NR	NTN			
	30,000	9,000	0,02	51103	34	NTN-SNR			
	30,000	9,000	0,03	51103J	34	NTN			
	35,000	7,000	0,03	SX03A48LLUA	2	NTN			
	35,000	8,000	0,03	16003	1	NTN-SNR			
	35,000	9,000	0,03	SX03A49LLUA	2	NTN			
	35,000	10,000	0,04	6003	1	NTN-SNR			
	35,000	10,000	0,04	6003E	1	SNR			
	35,000	10,000	0,05	6003EE	1	SNR			
	35,000	10,000	0,04	6003FT150	1	SNR			
	35,000	10,000	0,05	6003FT150ZZ	1	SNR			
	35,000	10,000	0,04	6003HVZZ	1	SNR			
	35,000	10,000	0,04	6003LB	1	NTN			
	35,000	10,000	0,04	6003LBU	1	NTN			
	35,000	10,000	0,04	6003LBZ	1	NTN			
	35,000	10,000	0,04	6003LLB	1	NTN			
	35,000	10,000	0,04	6003LLBNR	1-NR	NTN			
	35,000	10,000	0,04	6003LLH	1	NTN			
	35,000	10,000	0,04	6003LLU	1	NTN			
	35,000	10,000	0,04	6003LLUN	1-NR	NTN			
	35,000	10,000	0,04	6003LLUNR	1-NR	NTN			
	35,000	10,000	0,05	6003LT	1	SNR			
	35,000	10,000	0,05	6003LTZZ	1	SNR			
	35,000	10,000	0,04	6003LU	1	NTN			
	35,000	10,000	0,04	6003NR	1-NR	NTN			
	35,000	10,000	0,05	6003NREE	1-NR	SNR			
	35,000	10,000	0,04	6003Z	1	NTN-SNR			
	35,000	10,000	0,04	6003ZNR	1-NR	NTN			
	35,000	10,000	0,04	6003ZZ	1	NTN-SNR			
	35,000	10,000	0,04	6003ZZN	1-NR	NTN			
	35,000	10,000	0,04	6003ZZNR	1-NR	NTN			
	35,000	10,000	0,04	7003	2	NTN			
	35,000	10,000	0,07	S60032RS	1	SNR			
	35,000	10,000	0,04	SSN003LL	1	NTN			
	35,000	12,000	0,05	51203	34	NTN-SNR			
	35,000	12,000	0,05	51203J	34	NTN			
	35,000	14,000	0,06	63003EE	1	SNR			
	35,000	20,000	0,09	7003DB	2	NTN			
	35,000	20,000	0,09	7003DF	2	NTN			
	35,000	20,000	0,09	7003DT	2	NTN			
	35,000	30,000	0,11	7003DFT	2	NTN			
	40,000	12,000	0,08	1203G15	6	SNR			
	40,000	12,000	0,07	1203S	6	NTN			
40,000	12,000	0,07	6203	1	NTN-SNR				
40,000	12,000	0,07	6203E	1	SNR				
40,000	12,000	0,07	6203EE	1	SNR				
40,000	12,000	0,07	6203FT150	1	SNR				
40,000	12,000	0,07	6203FT150ZZ	1	SNR				
40,000	12,000	0,07	6203G15	1	SNR				
40,000	12,000	0,07	6203HT200ZZ	1	SNR				
40,000	12,000	0,07	6203HVZZ	1	SNR				
40,000	12,000	0,06	6203LB	1	NTN				
40,000	12,000	0,06	6203LLB	1	NTN				
40,000	12,000	0,07	6203LLBNR	1-NR	NTN				
40,000	12,000	0,06	6203LLH	1	NTN				

								Brands	
d	D	B	Kg	Reference					
17,000	40,000	12,000	0,06	6203LLU	1	NTN			
	40,000	12,000	0,06	6203LLUNR	1-NR	NTN			
	40,000	12,000	0,07	6203LT	1	SNR			
	40,000	12,000	0,07	6203LTZZ	1	SNR			
	40,000	12,000	0,06	6203LU	1	NTN			
	40,000	12,000	0,06	6203LUZ	1	NTN			
	40,000	12,000	0,07	6203N	1-NR	NTN			
	40,000	12,000	0,07	6203NR	1-NR	NTN-SNR			
	40,000	12,000	0,08	6203NREE	1-NR	SNR			
	40,000	12,000	0,07	6203NRZZ	1-NR	SNR			
	40,000	12,000	0,07	6203NZ	1-NR	SNR			
	40,000	12,000	0,07	6203SEE	1	SNR			
	40,000	12,000	0,06	6203Z	1	NTN-SNR			
	40,000	12,000	0,06	6203ZNR	1-NR	NTN			
	40,000	12,000	0,06	6203ZZ	1	NTN-SNR			
	40,000	12,000	0,07	6203ZZG15	1	SNR			
	40,000	12,000	0,07	6203ZZNR	1-NR	NTN			
	40,000	12,000	0,06	7203	2	NTN			
	40,000	12,000	0,07	7203B	2	NTN-SNR			
	40,000	12,000	0,07	7203BG	2	NTN			
	40,000	12,000	0,07	7203BGA	2	SNR			
	40,000	12,000	0,06	CS203(6203SEE)	12	SNR			
	40,000	12,000	0,06	CS203LLU	12	NTN			
	40,000	12,000	0,07	S62032RS	1	SNR			
	40,000	12,000	0,06	SSN203LL	1	NTN			
	40,000	14,288	0,08	8503	1	NTN			
	40,000	14,288	0,07	87503	1	NTN			
	40,000	16,000	0,10	2203EEG15	6	SNR			
	40,000	16,000	0,09	2203G15	6	SNR			
	40,000	16,000	0,09	2203S	6	NTN			
	40,000	16,000	0,10	4203A	4	SNR			
	40,000	16,000	0,09	62203EE	1	SNR			
	40,000	16,601	0,07	88503	1	NTN			
	40,000	16,601	0,09	WC88503	1	NTN			
	40,000	17,462	0,09	63203LB	1	NTN			
	40,000	17,462	0,09	63203LLU	1	NTN			
	40,000	17,462	0,09	63203ZZ	1	NTN			
	40,000	17,500	0,13	3203A	5	SNR			
	40,000	17,500	0,10	5203EEG15	5	SNR			
	40,000	17,500	0,10	5203NRZZG15	5-NR	SNR			
	40,000	17,500	0,09	5203S	5	NTN			
	40,000	17,500	0,11	5203SCLLD	5	NTN			
	40,000	17,500	0,11	5203SCLLM	5	NTN			
	40,000	17,500	0,11	5203SCZZ	5	NTN			
	40,000	17,500	0,10	5203ZZG15	5	SNR			
	40,000	18,000	0,110	TS3-DF0365LLBA1CS20PX1/LX0303	5	NTN			
	40,000	18,000	0,107	TS3-DF0365LLBA2C3/LX03	5	NTN			
	40,000	18,000	0,107	TS3-DF0365LLBA2CS22/LX0302	5	NTN			
	40,000	18,000	0,106	TS3-DF0365LLBA2V1	5	NTN			
	40,000	24,000	0,13	7203BDB	2	NTN			
40,000	24,000	0,13	7203BDF	2	NTN				
40,000	24,000	0,13	7203DB	2	NTN				
40,000	24,000	0,13	7203DF	2	NTN				
40,000	24,000	0,13	7203DT	2	NTN				
40,000	22/12	0,08	AS203D1	10	NTN				
40,000	22/12	0,10	ASS203N	15	NTN				
40,000	22/12	0,10	US203G2	10	SNR				
40,000	28,6/19	0,10	AEL203D1	11	NTN				
40,000	28,6/19	0,10	AELS203N	16	NTN				
40,000	28,6/19,1	0,13	ES203G2	11	SNR				
47,000	11,500	0,10	SC0342	1	NTN				
47,000	11,500	0,10	SC03A78	1	NTN				

d	D	B	Kg	Reference			Brands
17,000	47,000	12,000	0,10	SC0394	1	NTN	
	47,000	14,000	0,13	1303G14	6	SNR	
	47,000	14,000	0,13	1303S	6	NTN	
	47,000	14,000	0,12	6303	1	NTN-SNR	
	47,000	14,000	0,12	6303E	1	SNR	
	47,000	14,000	0,11	6303EE	1	SNR	
	47,000	14,000	0,12	6303FT150	1	SNR	
	47,000	14,000	0,12	6303FT150ZZ	1	SNR	
	47,000	14,000	0,11	6303G15	1	SNR	
	47,000	14,000	0,11	6303LB	1	NTN	
	47,000	14,000	0,12	6303LLB	1	NTN	
	47,000	14,000	0,12	6303LLBNR	1-NR	NTN	
	47,000	14,000	0,11	6303LLH	1	NTN	
	47,000	14,000	0,11	6303LLU	1	NTN	
	47,000	14,000	0,12	6303LLUNR	1-NR	NTN	
	47,000	14,000	0,11	6303LU	1	NTN	
	47,000	14,000	0,12	6303LUZ	1	NTN	
	47,000	14,000	0,12	6303NR	1-NR	NTN	
	47,000	14,000	0,11	6303Z	1	NTN-SNR	
	47,000	14,000	0,11	6303ZNR	1-NR	NTN	
	47,000	14,000	0,11	6303ZZ	1	NTN-SNR	
	47,000	14,000	0,12	6303ZZNR	1-NR	NTN	
	47,000	14,000	0,11	7303	2	NTN	
	47,000	14,000	0,12	7303B	2	NTN	
	47,000	14,000	0,12	7303BG	2	NTN	
	47,000	14,000	0,11	SSN303ZZ	1	NTN	
	47,000	19,000	0,17	2303EEG14	6	SNR	
	47,000	19,000	0,16	2303G14	6	SNR	
	47,000	19,000	0,15	2303S	6	NTN	
	47,000	19,000	0,17	4303A	4	SNR	
	47,000	19,000	0,15	62303EE	1	SNR	
	47,000	22,200	0,19	3303A	5	SNR	
	47,000	22,200	0,19	5303EEG15	5	SNR	
	47,000	22,200	0,19	5303NRZZG15	5-NR	SNR	
	47,000	22,200	0,14	5303S	5	NTN	
	47,000	22,200	0,09	5303SCLLD	5	NTN	
	47,000	22,200	0,09	5303SCLLM	5	NTN	
	47,000	22,200	0,09	5303SCZZ	5	NTN	
	47,000	22,200	0,19	5303ZZG15	5	SNR	
	47,000	28,000	0,23	7303BDB	2	NTN	
	47,000	28,000	0,23	7303DB	2	NTN	
	47,000	28,000	0,23	7303DF	2	NTN	
	47,000	31/16	0,18	UC203G2	7	SNR	
	47,000	31/17	0,18	UC203D1	7	NTN	
	47,000	31/17	0,18	UCS203LD1N	13	NTN	
	47,000	43,5/34	0,25	EX203G2	8	SNR	
	52,000	12,000	0,14	SC0390	1	NTN	
	52,000	17,000	0,17	SC0352LLUA	1	NTN	
52,000	21,000	0,22	62304LLU/17	1	NTN		
62,000	17,000	0,26	6403	1	NTN-SNR		
62,000	17,000	0,27	6403ZZ	1	NTN		
62,000	17,600	0,23	SX0344LLU	2	NTN		
19,050	41,275	11,112	0,07	R12LLB	1	NTN	
	41,275	11,112	0,07	R12LLU	1	NTN	
	41,275	11,112	0,07	R12ZZ	1	NTN	
	44,450	12,700	0,09	SC0493LLU	1	NTN	
20,000	27,000	4,000	0,01	6704	1	NTN	
	27,000	4,000	0,01	6704LLF	1	NTN	
	27,000	4,000	0,005	6704ZZ	1	NTN	
	32,000	7,000	0,02	6804	1	NTN	

d	D	B	Kg	Reference			Brands
20,000	32,000	7,000	0,02	6804LLB	1	NTN	
	32,000	7,000	0,02	6804LLU	1	NTN	
	32,000	7,000	0,02	6804LLUNR	1-NR	NTN	
	32,000	7,000	0,02	6804LU	1	NTN	
	32,000	7,000	0,02	6804NR	1-NR	NTN	
	32,000	7,000	0,02	6804Z	1	NTN	
	32,000	7,000	0,02	6804ZZ	1	NTN	
	32,000	7,000	0,02	6804ZZNR	1-NR	NTN	
	35,000	10,000	0,03	51104	34	NTN-SNR	
	37,000	9,000	0,04	6904	1	NTN	
	37,000	9,000	0,04	6904LB	1	NTN	
	37,000	9,000	0,03	6904LLB	1	NTN	
	37,000	9,000	0,03	6904LLU	1	NTN	
	37,000	9,000	0,03	6904LLUNR	1-NR	NTN	
	37,000	9,000	0,03	6904LU	1	NTN	
	37,000	9,000	0,04	6904NR	1-NR	NTN	
	37,000	9,000	0,03	6904Z	1	NTN	
	37,000	9,000	0,03	6904ZZ	1	NTN	
	37,000	9,000	0,04	6904ZZNR	1-NR	NTN	
	37,000	9,000	0,03	F-6904LLU	1	NTN	
	37,000	9,000	0,04	SSN904LL	1	NTN	
	37,000	9,000	0,03	SSN904ZZ	1	NTN	
	40,000	14,000	0,08	51204	34	NTN-SNR	
	42,000	7,000	0,05	6804ZZ/42	1	NTN	
	42,000	8,000	0,05	16004	1	NTN-SNR	
	42,000	9,000	0,05	SC0409	1	NTN	
	42,000	12,000	0,07	6004	1	NTN-SNR	
	42,000	12,000	0,07	6004E	1	SNR	
	42,000	12,000	0,07	6004EE	1	SNR	
	42,000	12,000	0,07	6004F600	1	SNR	
	42,000	12,000	0,08	6004F604	1	SNR	
	42,000	12,000	0,07	6004F605	1	SNR	
	42,000	12,000	0,07	6004FT150	1	SNR	
	42,000	12,000	0,07	6004FT150ZZ	1	SNR	
	42,000	12,000	0,07	6004HT200	1	SNR	
	42,000	12,000	0,07	6004HVZZ	1	SNR	
	42,000	12,000	0,07	6004LB	1	NTN	
	42,000	12,000	0,07	6004LLB	1	NTN	
	42,000	12,000	0,07	6004LLBNR	1-NR	NTN	
	42,000	12,000	0,07	6004LU	1	NTN	
	42,000	12,000	0,07	6004LLUNR	1-NR	NTN	
	42,000	12,000	0,07	6004LT	1	SNR	
	42,000	12,000	0,07	6004LTZZ	1	SNR	
	42,000	12,000	0,07	6004LU	1	NTN	
	42,000	12,000	0,07	6004NEE	1-NR	SNR	
	42,000	12,000	0,07	6004NR	1-NR	NTN-SNR	
	42,000	12,000	0,08	6004NREE	1-NR	SNR	
	42,000	12,000	0,08	6004NRZZ	1-NR	SNR	
42,000	12,000	0,07	6004Z	1	NTN-SNR		
42,000	12,000	0,07	6004ZNR	1-NR	NTN		
42,000	12,000	0,07	6004ZZ	1	NTN-SNR		
42,000	12,000	0,07	6004ZZNR	1-NR	NTN		
42,000	12,000	0,08	7004	2	NTN		
42,000	12,000	0,07	S60042RS	1	SNR		
42,000	12,000	0,07	SSN004LL	1	NTN		
42,000	12,000	0,07	SSN004ZZ	1	NTN		
42,000	16,000	0,09	63/32ZZ	1	NTN		
42,000	16,000	0,09	63004EE	1	SNR		
42,000	24,000	0,14	6004D2	1	NTN		
42,000	24,000	0,15	7004DB	2	NTN		
42,000	24,000	0,15	7004DF	2	NTN		
42,000	24,000	0,13	7004DT	2	NTN		

				Brands		
d	D	B	Kg	Reference	d	Brands
20,000	47,000	10,500	0,08	SC04A84	1	NTN
	47,000	12,000	0,09	SC0461	1	NTN
	47,000	12,000	0,09	SC04A31	1	NTN
	47,000	12,000	0,10	SC04A34	1	NTN
	47,000	14,000	0,12	1204	6	SNR
	47,000	14,000	0,12	1204S	6	NTN
	47,000	14,000	0,12	1204SK	6	NTN
	47,000	14,000	0,11	6204	1	NTN-SNR
	47,000	14,000	0,11	6204C	1	NTN
	47,000	14,000	0,11	6204E	1	SNR
	47,000	14,000	0,11	6204EE	1	SNR
	47,000	14,000	0,11	6204F600	1	SNR
	47,000	14,000	0,11	6204F604	1	SNR
	47,000	14,000	0,11	6204F605	1	SNR
	47,000	14,000	0,11	6204FT150	1	SNR
	47,000	14,000	0,11	6204FT150ZZ	1	SNR
	47,000	14,000	0,10	6204G15	1	SNR
	47,000	14,000	0,11	6204HT200	1	SNR
	47,000	14,000	0,10	6204HT200ZZ	1	SNR
	47,000	14,000	0,10	6204HVZZ	1	SNR
	47,000	14,000	0,10	6204LB	1	NTN
	47,000	14,000	0,10	6204LLB	1	NTN
	47,000	14,000	0,10	6204LLBNR	1-NR	NTN
	47,000	14,000	0,10	6204LLH	1	NTN
	47,000	14,000	0,10	6204LLU	1	NTN
	47,000	14,000	0,10	6204LLUN	1-NR	NTN
	47,000	14,000	0,11	6204LLUNR	1-NR	NTN
	47,000	14,000	0,11	6204LT	1	SNR
	47,000	14,000	0,11	6204LTZZ	1	SNR
	47,000	14,000	0,10	6204LU	1	NTN
	47,000	14,000	0,10	6204N	1-NR	SNR
	47,000	14,000	0,11	6204NR	1-NR	NTN-SNR
	47,000	14,000	0,11	6204NREE	1-NR	SNR
	47,000	14,000	0,11	6204NRZZ	1-NR	SNR
	47,000	14,000	0,13	6204SEE	1	SNR
	47,000	14,000	0,10	6204Z	1	NTN-SNR
	47,000	14,000	0,10	6204ZNR	1-NR	NTN
	47,000	14,000	0,10	6204ZZ	1	NTN-SNR
	47,000	14,000	0,10	6204ZZNR	1-NR	NTN
	47,000	14,000	0,10	7204	2	NTN
	47,000	14,000	0,11	7204B	2	NTN
	47,000	14,000	0,11	7204BA	2	SNR
	47,000	14,000	0,11	7204BG	2	NTN
	47,000	14,000	0,11	7204BGA	2	SNR
	47,000	14,000	0,10	CS204(6204SEE)	12	SNR
	47,000	14,000	0,10	CS204LLU	12	NTN
	47,000	14,000	0,10	F-6204	1	NTN
	47,000	14,000	0,11	S62042RS	1	SNR
	47,000	14,000	0,12	SC040	1	NTN
	47,000	14,000	0,12	SC04C50	1	NTN
	47,000	14,000	0,10	SSN204LL	1	NTN
	47,000	14,000	0,10	SSN204ZZ	1	NTN
	47,000	14,000	0,11	SX0469	2	NTN
	47,000	14,000	0,10	SX04A29	2	NTN
	47,000	15,875	0,11	WC87504	1	NTN
	47,000	17,750	0,11	88504	1	NTN
	47,000	18,000	0,15	2204EEG15	6	SNR
	47,000	18,000	0,14	2204G15	6	SNR
	47,000	18,000	0,16	2204KEEG15	6	SNR
	47,000	18,000	0,13	2204S	6	NTN
47,000	18,000	0,13	2204SK	6	NTN	
47,000	18,000	0,16	4204A	4	SNR	

				Brands		
d	D	B	Kg	Reference	d	Brands
20,000	47,000	18,000	0,14	51304	34	NTN
	47,000	18,000	0,14	62204EE	1	SNR
	47,000	18,000	0,12	SX04A77	2	NTN
	47,000	20,600	0,17	3204A	5	SNR
	47,000	20,600	0,16	5204EEG15	5	SNR
	47,000	20,600	0,16	5204NRZZG15	5-NR	SNR
	47,000	20,600	0,12	5204S	5	NTN
	47,000	20,600	0,12	5204SCLLD	5	NTN
	47,000	20,600	0,12	5204SCLLM	5	NTN
	47,000	20,600	0,12	5204SCZZ	5	NTN
	47,000	20,600	0,14	5204ZZG15	5	SNR
	47,000	20,600	0,15	63204LLB	1	NTN
	47,000	20,600	0,15	63204LLU	1	NTN
	47,000	20,600	0,15	63204ZZ	1	NTN
	47,000	28,000	0,21	7204BDB	2	NTN
	47,000	28,000	0,21	7204BDF	2	NTN
	47,000	28,000	0,21	7204DB	2	NTN
	47,000	28,000	0,21	7204DF	2	NTN
	47,000	28,000	0,21	7204DT	2	NTN
	47,000	14/40	0,18	11204G15	6	SNR
	47,000	25/14	0,13	AS204D1	10	NTN
	47,000	25/14	0,17	ASS204N	15	NTN
	47,000	25/14	0,13	CUS204	15	SNR
	47,000	25/14	0,13	US204G2	10	SNR
	47,000	30,9/21,4	0,15	ES204G2	11	SNR
	47,000	31/16	0,17	UC204G2	7	SNR
	47,000	31/17	0,20	CUC204	13	SNR
	47,000	31/17	0,17	UC204D1	7	NTN
	47,000	31/17	0,17	UCS204LD1N	13	NTN
	47,000	31/21,5	0,17	AEL204D1	11	NTN
	47,000	31/21,5	0,17	AELS204N	16	NTN
	47,000	31/21,5	0,15	CES204	16	SNR
	47,000	43,5/34	0,22	EX204G2	8	SNR
	47,000	43,7/34,2	0,22	CEX204	14	SNR
	47,000	43,7/34,2	0,23	UEL204D1	8	NTN
	47,000	43,7/34,2	0,23	UELS204LD1N	14	NTN
	52,000	12,000	0,14	SC04A47	1	NTN
	52,000	12,000	0,13	SC04A50	1	NTN
	52,000	12,000	0,14	SC04B27	1	NTN
	52,000	15,000	0,16	1304G15	6	SNR
	52,000	15,000	0,15	1304S	6	NTN
	52,000	15,000	0,15	1304SK	6	NTN
	52,000	15,000	0,14	6304	1	NTN-SNR
	52,000	15,000	0,14	6304E	1	SNR
	52,000	15,000	0,15	6304EE	1	SNR
	52,000	15,000	0,15	6304FT150	1	SNR
	52,000	15,000	0,15	6304FT150ZZ	1	SNR
	52,000	15,000	0,14	6304G15	1	SNR
	52,000	15,000	0,15	6304HT200	1	SNR
	52,000	15,000	0,15	6304HT200ZZ	1	SNR
	52,000	15,000	0,14	6304LB	1	NTN
	52,000	15,000	0,15	6304LLB	1	NTN
	52,000	15,000	0,15	6304LLBNR	1-NR	NTN
	52,000	15,000	0,14	6304LLH	1	NTN
	52,000	15,000	0,14	6304LLU	1	NTN
	52,000	15,000	0,15	6304LLUNR	1-NR	NTN
	52,000	15,000	0,14	6304LTZZ	1	SNR
	52,000	15,000	0,14	6304LU	1	NTN
	52,000	15,000	0,15	6304NEE	1-NR	SNR
	52,000	15,000	0,15	6304NR	1-NR	NTN-SNR
52,000	15,000	0,15	6304NREE	1-NR	SNR	
52,000	15,000	0,14	6304NRZ	1-NR	SNR	

								Brands	
d	D	B	Kg	Reference					
20,000	52,000	15,000	0,14	6304Z	1	NTN-SNR			
	52,000	15,000	0,14	6304ZNR	1-NR	NTN			
	52,000	15,000	0,14	6304ZZ	1	NTN-SNR			
	52,000	15,000	0,14	6304ZZN	1-NR	NTN			
	52,000	15,000	0,14	6304ZZNR	1-NR	NTN			
	52,000	15,000	0,14	7304	2	NTN			
	52,000	15,000	0,14	7304B	2	NTN-SNR			
	52,000	15,000	0,15	7304BG	2	NTN			
	52,000	15,000	0,15	7304BGA	2	SNR			
	52,000	15,000	0,14	F-6304J1	1	NTN			
	52,000	15,000	0,15	S63042RS	1	SNR			
	52,000	15,000	0,14	SSN304ZZ	1	NTN			
	52,000	20,000	0,20	SX0401ZZ	2	NTN			
	52,000	21,000	0,22	2304EEG15	6	SNR			
	52,000	21,000	0,19	2304S	6	NTN			
	52,000	21,000	0,19	2304SK	6	NTN			
	52,000	21,000	0,21	4304A	4	SNR			
	52,000	21,000	0,20	62304EE	1	SNR			
	52,000	22,200	0,24	3304B	5	SNR			
	52,000	22,200	0,22	5304EEG15	5	SNR			
	52,000	22,200	0,23	5304NRZZG15	5-NR	SNR			
	52,000	22,200	0,23	5304S	5	NTN			
	52,000	22,200	0,22	5304ZZG15	5	SNR			
	52,000	22,200	0,21	63304LLB	1	NTN			
	52,000	22,200	0,21	63304LLU	1	NTN			
	52,000	22,200	0,21	63304ZZ	1	NTN			
	52,000	23,000	0,22	88604	1	NTN			
	52,000	30,000	0,29	7304BDB	2	NTN			
	52,000	30,000	0,29	7304BDF	2	NTN			
	52,000	30,000	0,29	7304DB	2	NTN			
	52,000	30,000	0,28	7304DF	2	NTN			
	55,000	11,000	0,13	SC04B25	1	NTN			
	56,000	12,000	0,17	SC04B19	1	NTN			
	56,000	16,000	0,18	63/22C/20	1	NTN			
	62,000	27/21	0,49	UK305G2H	9	SNR			
	72,000	19,000	0,40	6404	1	NTN-SNR			
	72,000	19,000	0,40	6404Z	1	NTN			
	72,000	19,000	0,41	6404ZZ	1	NTN			
	21,300	35,000	7,000	0,03	SC04A55LLB	1	NTN		
	22,000	33,500	7,000	0,02	SC041	1	NTN		
		33,500	7,000	0,02	SC041Z	1	NTN		
		33,500	7,000	0,01	SC041ZZ	1	NTN		
33,500		7,000	0,02	SC04C41	1	NTN			
33,500		7,000	0,02	SC04C41Z	1	NTN			
33,500		7,000	0,01	SC04C41ZZ	1	NTN			
34,000		7,000	0,02	68/22ZZ	1	NTN			
39,000		9,000	0,04	69/22	1	NTN			
42,000		8,000	0,04	16004/22	1	NTN			
42,000		8,000	0,04	SC04C10	1	NTN			
42,000		8,000	0,04	SC04C11	1	NTN			
42,000		8,000	0,04	SF04A49	2	NTN			
44,000		12,000	0,08	60/22	1	NTN			
44,000		12,000	0,07	60/22LLB	1	NTN			
44,000		12,000	0,07	60/22LLU	1	NTN			
44,000		12,000	0,07	60/22LU	1	NTN			
44,000		12,000	0,07	60/22N	1-NR	NTN			
44,000		12,000	0,07	60/22Z	1	NTN			
44,000		12,000	0,08	60/22ZZ	1	NTN			
44,000		12,000	0,08	60/22ZZNR	1-NR	NTN			
47,000		14,000	0,10	6204/22	1	NTN			

								Brands	
d	D	B	Kg	Reference					
22,000	47,000	14,000	0,10	6204LLU/22	1	NTN			
	48,000	20,600	0,166	DF0484NX	5	NTN			
	50,000	14,000	0,12	62/22	1	NTN			
	50,000	14,000	0,12	62/22C	1	NTN			
	50,000	14,000	0,12	62/22LB	1	NTN			
	50,000	14,000	0,11	62/22LLB	1	NTN			
	50,000	14,000	0,12	62/22LLH	1	NTN			
	50,000	14,000	0,12	62/22LLU	1	NTN			
	50,000	14,000	0,12	62/22LU	1	NTN			
	50,000	14,000	0,12	62/22N	1-NR	NTN			
	50,000	14,000	0,12	62/22NR	1-NR	NTN			
	50,000	14,000	0,11	62/22ZZ	1	NTN			
	50,000	14,000	0,11	62/22ZZNR	1-NR	NTN			
	52,000	14,000	0,13	SX04B25	2	NTN			
	52,000	15,000	0,13	6304/22	1	NTN			
	54,000	14,000	0,14	SX04A81	2	NTN			
	56,000	14,000	0,16	SC04A89	1	NTN			
	56,000	14,000	0,16	SX0483	2	NTN			
	56,000	15,000	0,17	SC04A73	1	NTN			
	56,000	15,000	0,16	SX04A90	2	NTN			
	56,000	16,000	0,18	63/22	1	NTN			
	56,000	16,000	0,14	63/22LLU	1	NTN			
	56,000	16,000	0,17	63/22LU	1	NTN			
	56,000	16,000	0,18	63/22N	1-NR	NTN			
	56,000	16,000	0,18	63/22NR	1-NR	NTN			
	56,000	16,000	0,18	63/22X	1	NTN			
	56,000	16,000	0,14	63/22Z	1	NTN			
	56,000	16,000	0,14	63/22ZZ	1	NTN			
	56,000	16,000	0,14	63/22ZZNR	1-NR	NTN			
	56,000	16,000	0,190	QJ3/22AX2T2	3	NTN			
	56,000	17,000	0,19	SC04B66LLU	1	NTN			
	62,000	17,000	0,24	6305Z/22	1	NTN			
	65,000	18,000	0,26	SX04A34	2	NTN			
	70,000	18,000	0,35	SF0499	2	NTN			
	70,000	18,000	0,35	SF04A12	2	NTN			
	76,000	19,000	0,45	SF04A48	2	NTN			
	22,200	56,000	21,000	0,23	623/22LLUA/222	1	NTN		
	22,225	40,000	12,000	0,07	SC04B16ZZ	1	NTN		
		47,625	12,700	0,10	R14LLB	1	NTN		
		47,625	12,700	0,10	R14LLU	1	NTN		
	22,800	69,500	13,000	0,22	SX05B80	2	NTN		
		57,000	25,400	0,285	DF0596N	5	NTN		
24,000	37,000	6,000	0,02	SC0596	1	NTN			
	46,500	10,000	0,07	SX05B59	2	NTN			
	56,000	14,000	0,15	SX05A52	2	NTN			
	56,000	22,100	0,239	TM-DF05A28CS18	5	NTN			
25,000	32,000	4,000	0,01	6705	1	NTN			
	32,000	4,000	0,01	6705LLF	1	NTN			
	37,000	7,000	0,02	6805	1	NTN			
	37,000	7,000	0,02	6805BLU	1	NTN			
	37,000	7,000	0,02	6805LLB	1	NTN			
	37,000	7,000	0,02	6805LLU	1	NTN			
	37,000	7,000	0,02	6805LLUN	1-NR	NTN			
	37,000	7,000	0,02	6805LU	1	NTN			
	37,000	7,000	0,02	6805Z	1	NTN			
	37,000	7,000	0,02	6805ZZ	1	NTN			



								Brands	
d	D	B	Kg	Reference					
25,000	37,000	7,000	0,02	6805ZZNR	1-NR	NTN			
	42,000	7,000	0,04	6905	1	NTN			
	42,000	9,000	0,04	6905LLB	1	NTN			
	42,000	9,000	0,04	6905LLH	1	NTN			
	42,000	9,000	0,04	6905LLU	1	NTN			
	42,000	9,000	0,04	6905LLUNR	1-NR	NTN			
	42,000	9,000	0,04	6905LU	1	NTN			
	42,000	9,000	0,04	6905NR	1-NR	NTN			
	42,000	9,000	0,04	6905Z	1	NTN			
	42,000	9,000	0,04	6905ZZ	1	NTN			
	42,000	9,000	0,04	6905ZZNR	1-NR	NTN			
	42,000	9,000	0,05	7905	2	NTN			
	42,000	9,000	0,04	SSN905ZZ	1	NTN			
	42,000	11,000	0,05	51105	34	NTN-SNR			
	42,000	11,000	0,06	51105J	34	NTN			
	47,000	8,000	0,06	16005	1	NTN-SNR			
	47,000	8,000	0,06	SF05A40	2	NTN			
	47,000	8,000	0,06	SF05A78	2	NTN			
	47,000	10,500	0,07	SC057	1	NTN			
	47,000	10,500	0,07	SC05C27	1	NTN			
	47,000	12,000	0,08	6005	1	NTN-SNR			
	47,000	12,000	0,08	6005E	1	SNR			
	47,000	12,000	0,08	6005EE	1	SNR			
	47,000	12,000	0,08	6005FT150	1	SNR			
	47,000	12,000	0,08	6005FT150ZZ	1	SNR			
	47,000	12,000	0,08	6005G15	1	SNR			
	47,000	12,000	0,08	6005HVZZ	1	SNR			
	47,000	12,000	0,08	6005LB	1	NTN			
	47,000	12,000	0,08	6005LLB	1	NTN			
	47,000	12,000	0,08	6005LLBNR	1-NR	NTN			
	47,000	12,000	0,08	6005LLH	1	NTN			
	47,000	12,000	0,08	6005LLU	1	NTN			
	47,000	12,000	0,08	6005LLUNR	1-NR	NTN			
	47,000	12,000	0,09	6005LT	1	SNR			
	47,000	12,000	0,09	6005LTZZ	1	SNR			
	47,000	12,000	0,08	6005LU	1	NTN			
	47,000	12,000	0,08	6005LUZ	1	NTN			
	47,000	12,000	0,08	6005N	1-NR	NTN-SNR			
	47,000	12,000	0,08	6005NR	1-NR	NTN			
	47,000	12,000	0,08	6005Z	1	NTN-SNR			
	47,000	12,000	0,08	6005ZNR	1-NR	NTN			
	47,000	12,000	0,08	6005ZZ	1	NTN-SNR			
	47,000	12,000	0,08	6005ZZNR	1-NR	NTN			
	47,000	12,000	0,09	7005	2	NTN			
	47,000	12,000	0,08	F-6005J1LLU	1	NTN			
	47,000	12,000	0,08	S60052RS	1	SNR			
	47,000	12,000	0,08	SSN005LL	1	NTN			
	47,000	12,000	0,08	SSN005ZZ	1	NTN			
	47,000	15,000	0,11	51205	34	NTN-SNR			
	47,000	15,000	0,11	51205J	34	NTN			
	47,000	16,000	0,11	63005EE	1	SNR			
	47,000	24,000	0,18	7005DB	2	NTN			
47,000	24,000	0,18	7005DF	2	NTN				
47,000	24,000	0,18	7005DT	2	NTN				
48,000	27,000	0,11	SX05A66	2	NTN				
48,600	15,800	0,12	25TAG12	34	NTN				
50,000	8,000	0,07	16005/50	1	NTN				
50,000	12,000	0,10	6005LU/50	1	NTN				
52,000	13,000	0,12	SC05A51	1	NTN				
52,000	15,000	0,15	1205	6	SNR				
52,000	15,000	0,13	1205K	6	SNR				
52,000	15,000	0,14	1205S	6	NTN				

								Brands	
d	D	B	Kg	Reference					
25,000	52,000	15,000	0,14	1205SK	6	NTN			
	52,000	15,000	0,13	6205	1	NTN-SNR			
	52,000	15,000	0,13	6205C	1	NTN			
	52,000	15,000	0,13	6205E	1	SNR			
	52,000	15,000	0,14	6205EE	1	SNR			
	52,000	15,000	0,13	6205F600	1	SNR			
	52,000	15,000	0,13	6205F604	1	SNR			
	52,000	15,000	0,14	6205FT150	1	SNR			
	52,000	15,000	0,14	6205FT150ZZ	1	SNR			
	52,000	15,000	0,13	6205G15	1	SNR			
	52,000	15,000	0,14	6205HT200	1	SNR			
	52,000	15,000	0,14	6205HT200ZZ	1	SNR			
	52,000	15,000	0,13	6205HVZZ	1	SNR			
	52,000	15,000	0,13	6205KEE	1	SNR			
	52,000	15,000	0,12	6205LB	1	NTN			
	52,000	15,000	0,12	6205LBU	1	NTN			
	52,000	15,000	0,12	6205LLB	1	NTN			
	52,000	15,000	0,13	6205LLBNR	1-NR	NTN			
	52,000	15,000	0,12	6205LLH	1	NTN			
	52,000	15,000	0,13	6205LLU	1	NTN			
	52,000	15,000	0,12	6205LLUN	1-NR	NTN			
	52,000	15,000	0,13	6205LLUNR	1-NR	NTN			
	52,000	15,000	0,14	6205LT	1	SNR			
	52,000	15,000	0,14	6205LTZZ	1	SNR			
	52,000	15,000	0,12	6205LU	1	NTN			
	52,000	15,000	0,13	6205LUZ	1	NTN			
	52,000	15,000	0,13	6205N	1-NR	NTN-SNR			
	52,000	15,000	0,13	6205NEE	1-NR	SNR			
	52,000	15,000	0,13	6205NR	1-NR	NTN-SNR			
	52,000	15,000	0,14	6205NREE	1-NR	SNR			
	52,000	15,000	0,14	6205NRZ	1-NR	SNR			
	52,000	15,000	0,13	6205NRZZ	1-NR	SNR			
	52,000	15,000	0,12	6205Z	1	NTN-SNR			
	52,000	15,000	0,13	6205ZNR	1-NR	NTN			
	52,000	15,000	0,12	6205ZZ	1	NTN-SNR			
	52,000	15,000	0,13	6205ZZN	1-NR	NTN			
	52,000	15,000	0,13	6205ZZNR	1-NR	NTN			
	52,000	15,000	0,13	7205BG	2	NTN			
	52,000	15,000	0,13	7205BGA	2	SNR			
	52,000	15,000	0,13	CS205(6205SEE)	12	SNR			
	52,000	15,000	0,13	CS205LLU	12	NTN			
	52,000	15,000	0,12	F-6205J1LLU	1	NTN			
	52,000	15,000	0,158	QJ205	3	NTN			
	52,000	15,000	0,13	S62052RS	1	SNR			
	52,000	15,000	0,12	SSN205LL	1	NTN			
	52,000	15,000	0,12	SSN205ZZ	1	NTN			
	52,000	15,000	0,12	SX05A87	2	NTN			
	52,000	15,875	0,13	8505	1	NTN			
	52,000	15,875	0,18	87505	1	NTN			
	52,000	18,000	0,17	2205	6	SNR			
	52,000	18,000	0,16	2205EEG15	6	SNR			
	52,000	18,000	0,16	2205G15	6	SNR			
52,000	18,000	0,16	2205K	6	SNR				
52,000	18,000	0,17	2205KEEG15	6	SNR				
52,000	18,000	0,15	2205S	6	NTN				
52,000	18,000	0,15	2205SK	6	NTN				
52,000	18,000	0,17	4205A	4	SNR				
52,000	18,000	0,16	51305	34	NTN-SNR				
52,000	18,000	0,16	62205EE	1	SNR				
52,000	20,600	0,20	3205B	5	SNR				
52,000	20,600	0,186	3TM-DF05A35NX16RX3W3-5CS25	5	NTN				
52,000	20,600	0,17	5205EEG15EE	5	SNR				

								Brands	
d	D	B	Kg	Reference					
25,000	62,000	46,8/34,9	0,45	UELS305D1N	14				NTN
	65,000	17,000	0,27	6305/65	1				NTN
	68,000	12,000	0,24	SC05B31	1				NTN
	72,000	30/24	0,59	UK306G2H	9				SNR
	80,000	21,000	0,53	6405	1				NTN-SNR
	80,000	21,000	0,51	6405Z	1				NTN
	80,000	21,000	0,53	6405ZZ	1				NTN
25,400	34,925	4,762	0,01	KXS010	3				NTN
	34,925	9,524	0,03	KYS010DB	2				NTN
	50,800	12,700	0,11	R16LBLU	1				NTN
	50,800	12,700	0,11	R16LLB	1				NTN
	50,800	12,700	0,11	R16LLU	1				NTN
	50,800	12,700	0,11	R16ZZ	1				NTN
	52,000	15,000	0,12	6205/254	1				NTN
25,700	42,000	9,000	0,04	6905/257	1				NTN
26,000	37,000	6,000	0,02	SC05A82	1				NTN
	47,000	15,000	0,10	SF0581	2				NTN
	47,000	15,000	0,07	SF05A26	2				NTN
	52,000	15,000	0,11	6205/26	1				NTN
	52,000	16,749	0,13	88026	1				NTN
	58,000	15,000	0,16	SC05A61	1				NTN
	62,000	14,000	0,19	SC05B76	1				NTN
	64,000	16,000	0,24	SC05A58	1				NTN
	68,000	14,000	0,25	SC05B26	1				NTN
	70,000	17,000	0,31	SC05A59	1				NTN
	72,000	15,500	0,32	SF05A84	2				NTN
	75,000	19,000	0,39	SC05B43	1				NTN
27,000	52,000	15,000	0,12	6205/27	1				NTN
28,000	47,000	9,000	0,06	6906/28	1				NTN
	51,600	15,800	0,12	28TAG12	34				NTN
	52,000	12,000	0,10	60/28	1				NTN
	52,000	12,000	0,09	60/28LLB	1				NTN
	52,000	12,000	0,10	60/28LLU	1				NTN
	52,000	12,000	0,09	60/28LLUNR	1-NR				NTN
	52,000	12,000	0,09	60/28LU	1				NTN
	52,000	12,000	0,10	60/28LUNR	1-NR				NTN
	52,000	12,000	0,10	60/28NR	1-NR				NTN
	52,000	12,000	0,09	60/28Z	1				NTN
	52,000	12,000	0,10	60/28ZZ	1				NTN
	52,000	12,000	0,09	60/28ZZNR	1-NR				NTN
	52,000	24,000	0,20	60/28NRD2	1-NR				NTN
	54,000	20,600	0,173	DF0679PX1	5				NTN
	58,000	16,000	0,17	62/28	1				NTN
	58,000	16,000	0,17	62/28LLB	1				NTN
	58,000	16,000	0,17	62/28LLH	1				NTN
	58,000	16,000	0,17	62/28LLU	1				NTN
	58,000	16,000	0,17	62/28LLUNR	1-NR				NTN
	58,000	16,000	0,17	62/28LU	1				NTN
	58,000	16,000	0,17	62/28NR	1-NR				NTN
	58,000	16,000	0,17	62/28ZZ	1				NTN
	58,000	16,000	0,17	62/28ZZNR	1-NR				NTN
	60,000	15,000	0,18	SC06A68	1				NTN
	62,000	16,000	0,20	6206LUA/28	1				NTN
	64,000	18,000	0,25	SF06A49	2				NTN
	68,000	18,000	0,28	63/28	1				NTN
	68,000	18,000	0,29	63/28LLB	1				NTN
	68,000	18,000	0,28	63/28LLHN	1-NR				NTN

								Brands		
d	D	B	Kg	Reference						
28,000	68,000	18,000	0,29	63/28LLU	1				NTN	
	68,000	18,000	0,28	63/28LLUNR	1-NR				NTN	
	68,000	18,000	0,26	63/28NR	1-NR				NTN	
	68,000	18,000	0,28	63/28Z	1				NTN	
	68,000	18,000	0,29	63/28ZZ	1				NTN	
	68,000	18,000	0,31	QJ3/28	3				NTN	
	68,000	18,000	0,309	QJ3/28V1	3				NTN	
	72,000	18,000	0,35	SF06A24	2				NTN	
	78,000	20,000	0,45	SC0690	1				NTN	
	78,000	20,000	0,46	SF06A27	2				NTN	
	28,575	53,970	9,400	0,09	SC0612	1				NTN
53,975		12,700	0,11	R18LLU	1				NTN	
53,975		12,700	0,11	R18ZZ	1				NTN	
29,000	52,000	12,000	0,09	60/28/29	1				NTN	
30,000	37,000	4,000	0,01	6706	1				NTN	
	37,000	4,000	0,01	6706LLF	1				NTN	
	42,000	7,000	0,03	6806	1				NTN	
	42,000	7,000	0,02	6806LLB	1				NTN	
	42,000	7,000	0,02	6806LLH	1				NTN	
	42,000	7,000	0,02	6806LLU	1				NTN	
	42,000	7,000	0,02	6806LLUN	1-NR				NTN	
	42,000	7,000	0,02	6806LLUNR	1-NR				NTN	
	42,000	7,000	0,02	6806ZZ	1				NTN	
	42,000	7,000	0,02	6806ZZNR	1-NR				NTN	
	47,000	9,000	0,05	6906	1				NTN	
	47,000	9,000	0,05	6906LB	1				NTN	
	47,000	9,000	0,05	6906LLB	1				NTN	
	47,000	9,000	0,04	6906LLH	1				NTN	
	47,000	9,000	0,04	6906LLU	1				NTN	
	47,000	9,000	0,04	6906LU	1				NTN	
	47,000	9,000	0,05	6906NR	1-NR				NTN	
	47,000	9,000	0,04	6906Z	1				NTN	
	47,000	9,000	0,04	6906ZZ	1				NTN	
	47,000	9,000	0,05	6906ZZN	1-NR				NTN	
	47,000	9,000	0,05	6906ZZNR	1-NR				NTN	
	47,000	9,000	0,06	7906	2				NTN	
	47,000	11,000	0,06	51106	34				NTN-SNR	
	47,000	11,000	0,06	51106J	34				NTN	
	47,000	18,000	0,086	2TS2-DF06A78LLA4-BC-S28PX1/L696	5				NTN	
	47,000	18,000	0,087	2TS2-DF06A78LLA4-BCS28PX1V1	5				NTN	
	47,000	18,000	0,10	7906DB	2				NTN	
	50,000	13,000	0,12	6006LLB	1				NTN	
	52,000	16,000	0,13	51206	34				NTN-SNR	
	52,000	16,000	0,14	51206J	34				NTN	
55,000	9,000	0,09	16006	1				NTN-SNR		
55,000	11,000	0,10	SC0698	1				NTN		
55,000	13,000	0,12	6006	1				NTN-SNR		
55,000	13,000	0,12	6006E	1				SNR		
55,000	13,000	0,12	6006EE	1				SNR		
55,000	13,000	0,12	6006FT150	1				SNR		
55,000	13,000	0,12	6006FT150ZZ	1				SNR		
55,000	13,000	0,12	6006HVZZ	1				SNR		
55,000	13,000	0,11	6006LB	1				NTN		
55,000	13,000	0,12	6006LLBNR	1-NR				NTN		
55,000	13,000	0,11	6006LLH	1				NTN		
55,000	13,000	0,12	6006LLU	1				NTN		
55,000	13,000	0,11	6006LLUN	1-NR				NTN		
55,000	13,000	0,12	6006LLUNR	1-NR				NTN		
55,000	13,000	0,12	6006LT	1				SNR		

d	D	B	Kg	Reference			Brands
30,000	55,000	13,000	0,12	6006LTZZ	1	SNR	
	55,000	13,000	0,11	6006LU	1	NTN	
	55,000	13,000	0,12	6006N	1-NR	SNR	
	55,000	13,000	0,12	6006NR	1-NR	NTN-SNR	
	55,000	13,000	0,12	6006NREE	1-NR	SNR	
	55,000	13,000	0,13	6006NRZZ	1-NR	SNR	
	55,000	13,000	0,11	6006Z	1	NTN-SNR	
	55,000	13,000	0,11	6006ZNR	1-NR	NTN	
	55,000	13,000	0,12	6006ZZ	1	NTN-SNR	
	55,000	13,000	0,11	6006ZZNR	1-NR	NTN	
	55,000	13,000	0,14	7006	2	NTN	
	55,000	13,000	0,12	F-6006LLU	1	NTN	
	55,000	13,000	0,12	S60062RS	1	SNR	
	55,000	13,000	0,11	SSN006LL	1	NTN	
	55,000	13,000	0,11	SSN006ZZ	1	NTN	
	55,000	17,000	0,15	SF0649	2	NTN	
	55,000	19,000	0,17	63006EE	1	SNR	
	55,000	23,000	0,203	2TS2-DF0667LLUCS21/7NQ1	5	NTN	
	55,000	23,017	0,209	DF0617LLUCS25/L417	5	NTN	
	55,000	23,017	0,205	DF0617LLU-N1/L417	5	NTN	
	55,000	23,017	0,207	DF0654LLUC4/5C	5	NTN	
	55,000	26,000	0,26	7006DB	2	NTN	
	55,000	26,000	0,26	7006DF	2	NTN	
	55,000	26,000	0,26	7006DT	2	NTN	
	58,000	21,500	0,224	DF06A51	5	NTN	
	60,000	21,000	0,26	51306	34	NTN-SNR	
	62,000	11,303	0,14	SX0621	2	NTN	
	62,000	16,000	0,23	1206	6	SNR	
	62,000	16,000	0,22	1206G14	6	SNR	
	62,000	16,000	0,22	1206K	6	SNR	
	62,000	16,000	0,22	1206KG14	6	SNR	
	62,000	16,000	0,22	1206S	6	NTN	
	62,000	16,000	0,22	1206SK	6	NTN	
	62,000	16,000	0,19	6206	1	NTN-SNR	
	62,000	16,000	0,20	6206C	1	NTN	
	62,000	16,000	0,20	6206E	1	SNR	
	62,000	16,000	0,20	6206EE	1	SNR	
	62,000	16,000	0,20	6206F600	1	SNR	
	62,000	16,000	0,20	6206F604	1	SNR	
	62,000	16,000	0,20	6206FT150	1	SNR	
	62,000	16,000	0,21	6206FT150ZZ	1	SNR	
	62,000	16,000	0,19	6206G15	1	SNR	
	62,000	16,000	0,21	6206HT200	1	SNR	
	62,000	16,000	0,21	6206HT200ZZ	1	SNR	
	62,000	16,000	0,20	6206HVZZ	1	SNR	
	62,000	16,000	0,20	6206KEE	1	SNR	
	62,000	16,000	0,20	6206KZZ	1	SNR	
	62,000	16,000	0,20	6206LB	1	NTN	
	62,000	16,000	0,02	6206LLB	1	NTN	
	62,000	16,000	0,20	6206LLBNR	1-NR	NTN	
	62,000	16,000	0,17	6206LLH	1	NTN	
	62,000	16,000	0,19	6206LLHN	1-NR	NTN	
	62,000	16,000	0,17	6206LLU	1	NTN	
	62,000	16,000	0,19	6206LLUN	1-NR	NTN	
	62,000	16,000	0,20	6206LLUNR	1-NR	NTN	
	62,000	16,000	0,20	6206LT	1	SNR	
	62,000	16,000	0,20	6206LTZZ	1	SNR	
	62,000	16,000	0,20	6206LU	1	NTN	
	62,000	16,000	0,19	6206N	1-NR	NTN-SNR	
	62,000	16,000	0,20	6206NEE	1-NR	SNR	
	62,000	16,000	0,20	6206NR	1-NR	NTN-SNR	
	62,000	16,000	0,21	6206NREE	1-NR	SNR	

d	D	B	Kg	Reference			Brands
30,000	62,000	16,000	0,20	6206NRZ	1-NR	SNR	
	62,000	16,000	0,21	6206NRZZ	1-NR	SNR	
	62,000	16,000	0,19	6206Z	1	NTN-SNR	
	62,000	16,000	0,20	6206ZNR	1-NR	NTN	
	62,000	16,000	0,17	6206ZZ	1	NTN-SNR	
	62,000	16,000	0,17	6206ZZNR	1-NR	NTN	
	62,000	16,000	0,19	7206	2	NTN-SNR	
	62,000	16,000	0,20	7206B	2	NTN	
	62,000	16,000	0,20	7206BG	2	NTN	
	62,000	16,000	0,20	7206BGA	2	SNR	
	62,000	16,000	0,20	CS206(6206SEE)	12	SNR	
	62,000	16,000	0,20	CS206LLU	12	NTN	
	62,000	16,000	0,20	S62062RS	1	SNR	
	62,000	16,000	0,17	SSN206LL	1	NTN	
	62,000	16,000	0,17	SSN206ZZ	1	NTN	
	62,000	20,000	0,28	2206	6	SNR	
	62,000	20,000	0,27	2206EEG15	6	SNR	
	62,000	20,000	0,26	2206K	6	SNR	
	62,000	20,000	0,28	2206KEEG15	6	SNR	
	62,000	20,000	0,25	2206S	6	NTN	
	62,000	20,000	0,25	2206SK	6	NTN	
	62,000	20,000	0,26	4206A	4	SNR	
	62,000	20,000	0,25	62206EE	1	SNR	
	62,000	20,000	0,25	8506	1	NTN	
	62,000	20,000	0,25	87506	1	NTN	
	62,000	22,000	0,26	SX0658LL	2	NTN	
	62,000	23,000	0,29	SC06C88LL	1	NTN	
	62,000	23,000	0,29	SC06C88LLA	1	NTN	
	62,000	23,800	0,32	3206B	5	SNR	
	62,000	23,800	0,29	5206EEG15EE	5	SNR	
	62,000	23,800	0,30	5206NRZZG15	5-NR	SNR	
	62,000	23,800	0,29	5206S	5	NTN	
	62,000	23,800	0,29	5206SCLLD	5	NTN	
	62,000	23,800	0,29	5206SCLLM	5	NTN	
	62,000	23,800	0,29	5206SCZZ	5	NTN	
	62,000	23,800	0,29	5206ZZG15	5	SNR	
	62,000	23,800	0,29	63206LLB	1	NTN	
	62,000	23,800	0,29	63206LLU	1	NTN	
	62,000	23,800	0,29	63206ZZ	1	NTN	
	62,000	24,000	0,21	88506	1	NTN	
	62,000	25,000	0,27	SX06B79LLU	2	NTN	
	62,000	32,000	0,39	6206D2	1	NTN	
	62,000	32,000	0,39	6206LUD2	1	NTN	
	62,000	32,000	0,40	7206BDB	2	NTN	
	62,000	32,000	0,40	7206BDF	2	NTN	
	62,000	32,000	0,39	7206DB	2	NTN	
	62,000	32,000	0,39	7206DF	2	NTN	
	62,000	32,000	0,39	7206DT	2	NTN	
	62,000	16/48	0,35	11206G15	6	SNR	
	62,000	29/16	0,25	AS206D1	10	NTN	
	62,000	29/16	0,31	ASS206N	15	NTN	
	62,000	30/16	0,27	CUS206	15	SNR	
	62,000	30/16	0,27	US206G2	10	SNR	
	62,000	35,7/23,8	0,31	AEL206D1	11	NTN	
	62,000	35,7/23,8	0,31	AELS206N	16	NTN	
	62,000	35,7/23,8	0,33	CES206	16	SNR	
	62,000	35,7/23,8	0,33	ES206G2	11	SNR	
	62,000	38,1/19	0,35	CUC206	13	SNR	
	62,000	38,1/19	0,33	UC206	7	NTN-SNR	
	62,000	38,1/19	0,33	UCS206LD1N	13	NTN	
	62,000	48,3/36,4	0,41	EX206G2	8	SNR	
	62,000	48,4/36,5	0,41	CEX206	14	SNR	

								Brands	
d	D	B	Kg	Reference					
30,000	62,000	48,4/36,5	0,45	UEL206D1	8	NTN			
	62,000	48,4/36,5	0,45	UELS206LD1N	14	NTN			
	68,000	25,000	0,402	DF0693NV1	5	NTN			
	70,000	28,000	0,52	51406	34	NTN-SNR			
	72,000	16,000	0,31	SC0627	1	NTN			
	72,000	16,500	0,31	SC06C19LL	1	NTN			
	72,000	19,000	0,40	1306	6	SNR			
	72,000	19,000	0,40	1306K	6	SNR			
	72,000	19,000	0,39	1306S	6	NTN			
	72,000	19,000	0,39	1306SK	6	NTN			
	72,000	19,000	0,34	6306	1	NTN-SNR			
	72,000	19,000	0,34	6306C	1	NTN			
	72,000	19,000	0,35	6306E	1	SNR			
	72,000	19,000	0,36	6306EE	1	SNR			
	72,000	19,000	0,34	6306EG15	1	SNR			
	72,000	19,000	0,35	6306F600	1	SNR			
	72,000	19,000	0,36	6306FT150	1	SNR			
	72,000	19,000	0,36	6306FT150ZZ	1	SNR			
	72,000	19,000	0,37	6306HT200	1	SNR			
	72,000	19,000	0,35	6306HT200ZZ	1	SNR			
	72,000	19,000	0,36	6306LB	1	NTN			
	72,000	19,000	0,33	6306LLB	1	NTN			
	72,000	19,000	0,37	6306LLBNR	1-NR	NTN			
	72,000	19,000	0,35	6306LLH	1	NTN			
	72,000	19,000	0,33	6306LLU	1	NTN			
	72,000	19,000	0,36	6306LLUNR	1-NR	NTN			
	72,000	19,000	0,34	6306LU	1	NTN			
	72,000	19,000	0,34	6306N	1-NR	NTN-SNR			
	72,000	19,000	0,35	6306NR	1-NR	NTN-SNR			
	72,000	19,000	0,36	6306NREE	1-NR	SNR			
	72,000	19,000	0,36	6306NRZ	1-NR	SNR			
	72,000	19,000	0,37	6306NRZZ	1-NR	SNR			
	72,000	19,000	0,34	6306Z	1	NTN-SNR			
	72,000	19,000	0,33	6306ZNR	1-NR	NTN			
	72,000	19,000	0,33	6306ZZ	1	NTN-SNR			
	72,000	19,000	0,36	6306ZZNR	1-NR	NTN			
	72,000	19,000	0,39	7306	2	NTN-SNR			
	72,000	19,000	0,35	7306B	2	NTN			
	72,000	19,000	0,36	7306BG	2	NTN			
	72,000	19,000	0,35	7306BGA	2	SNR			
	72,000	19,000	0,34	CS306LLU	12	NTN			
	72,000	19,000	0,327	QJ306	3	NTN			
	72,000	19,000	0,42	QJ306MA	3	SNR			
	72,000	24,500	0,475	DF0680NV1	5	NTN			
	72,000	26,200	0,42	SX0673	2	NTN			
	72,000	27,000	0,51	2306	6	SNR			
	72,000	27,000	0,57	2306EEG15	6	SNR			
	72,000	27,000	0,50	2306K	6	SNR			
	72,000	27,000	0,48	2306S	6	NTN			
	72,000	27,000	0,48	2306SK	6	NTN			
72,000	27,000	0,52	4306A	4	SNR				
72,000	27,000	0,49	62306EE	1	SNR				
72,000	30,162	0,54	63306LLB	1	NTN				
72,000	30,162	0,54	63306ZZ	1	NTN				
72,000	30,200	0,60	3306B	5	SNR				
72,000	30,200	0,56	5306EEG15	5	SNR				
72,000	30,200	0,57	5306NRZZG15	5-NR	SNR				
72,000	30,200	0,51	5306S	5	NTN				
72,000	30,200	0,51	5306SCLLD	5	NTN				
72,000	30,200	0,51	5306SCLLM	5	NTN				
72,000	30,200	0,51	5306SCZZ	5	NTN				
72,000	30,200	0,51	5306ZZG15	5	SNR				

								Brands		
d	D	B	Kg	Reference						
30,000	72,000	30,200	0,54	63306LLU	1	NTN				
	72,000	38,000	0,68	6306D2	1	NTN				
	72,000	38,000	0,71	6306ZZD2	1	NTN				
	72,000	38,000	0,71	7306BDB	2	NTN				
	72,000	38,000	0,71	7306BDF	2	NTN				
	72,000	38,000	0,71	7306BDT	2	NTN				
	72,000	38,000	0,70	7306DB	2	NTN				
	72,000	38,000	0,70	7306DF	2	NTN				
	72,000	19/52	0,60	11306G15	6	SNR				
	72,000	29/23	0,59	UK306D1	9	NTN				
	72,000	42,9/20	0,68	UCX06	7	NTN				
	72,000	43/23	0,56	UC306D1	7	NTN				
	72,000	43/23	0,58	UCS306D1	13	NTN				
	72,000	43/24	0,56	UC306G2	7	SNR				
	72,000	50/36,5	0,68	EX306G2	8	SNR				
	72,000	50/36,5	0,69	UEL306D1	8	NTN				
	72,000	50/36,5	0,71	UELS306D1N	14	NTN				
	75,000	18,000	0,35	SX066	2	NTN				
	80,000	33/25	0,92	UK307G2H	9	SNR				
	90,000	23,000	0,74	6406	1	NTN-SNR				
	90,000	23,000	0,74	6406ZZ	1	NTN				
	90,000	23,000	0,82	7406BG	2	NTN				
	110,000	62,000	0,000	SX0687LL	2	NTN				
	120,000	62,000	3,48	SX0688LL	2	NTN				
	30,200	85,000	13,000	0,41	SC06D03	1	NTN			
	31,000	72,000	17,000	0,32	6207/31	1	NTN			
		75,000	16,500	0,33	SX06C02N	2	NTN			
	31,750	57,150	9,520	0,10	SC0663	1	NTN			
		57,150	12,700	0,13	R20LL	1	NTN			
57,150		12,700	0,13	R20LLB	1	NTN				
57,150		12,700	0,13	R20ZZ	1	NTN				
32,000	52,000	20,000	0,127	2TS2-DF0676LLHCS16PX1/5C	5	NTN				
	57,000	17,000	0,17	32TAG12	34	NTN				
	58,000	13,000	0,13	60/32	1	NTN				
	58,000	13,000	0,13	60/32LLB	1	NTN				
	58,000	13,000	0,13	60/32LLU	1	NTN				
	58,000	13,000	0,13	60/32LU	1	NTN				
	58,000	13,000	0,13	60/32ZZ	1	NTN				
	58,000	13,000	0,14	60/32ZZNR	1-NR	NTN				
	62,000	24,000	0,24	88506/32	1	NTN				
	65,000	17,000	0,23	62/32	1	NTN				
	65,000	17,000	0,22	62/32LLU	1	NTN				
	65,000	17,000	0,23	62/32NR	1-NR	NTN				
	65,000	17,000	0,23	62/32ZZNR	1-NR	NTN				
	65,000	17,000	0,23	62/32ZZ	1	NTN				
	72,000	19,000	0,30	SX06C03LLH	2	NTN				
	75,000	20,000	0,39	63/32	1	NTN				
	75,000	20,000	0,39	63/32LLU	1	NTN				
	75,000	20,000	0,40	63/32LLUNR	1-NR	NTN				
	75,000	20,000	0,39	63/32N	1-NR	NTN				
	75,000	20,000	0,40	63/32NR	1-NR	NTN				
75,000	20,000	0,38	63/32Z	1	NTN					
75,000	20,000	0,39	63/32ZNR	1-NR	NTN					
80,000	21,000	0,44	SX06C12LLH	2	NTN					
32,200	72,000	15,500	0,29	SC065C35LL	1	NTN				
33,000	55,000	15,000	0,11	SC07A42LL	1	NTN				

d	D	B	Kg	Reference			Brands
33,000	60,000	14,700	0,15	SF0724	2	NTN	
	60,000	17,100	0,16	SF0743	2	NTN	
	62,000	26,000	0,303	3TM-DF07A24CS25	5	NTN	
	72,000	17,000	0,30	6207/33	1	NTN	
34,000	55,000	10,000	0,08	6907LU/34	1	NTN	
	57,000	13,000	0,11	SC0732	1	NTN	
	60,000	22,000	0,19	SX077	2	NTN	
	68,000	20,000	0,26	SX07B72	2	NTN	
35,000	44,000	5,000	0,02	6707	1	NTN	
	44,000	5,000	0,02	6707LLF	1	NTN	
	47,000	7,000	0,03	6807	1	NTN	
	47,000	7,000	0,03	6807LLB	1	NTN	
	47,000	7,000	0,03	6807LLU	1	NTN	
	47,000	7,000	0,03	6807NR	1-NR	NTN	
	47,000	7,000	0,03	6807ZZ	1	NTN	
	47,000	7,000	0,03	6807ZZNR	1-NR	NTN	
	50,000	20,000	0,950	2TS2-DF0785LLA4X-GCS33/L417	5	NTN	
	50,000	20,000	0,109	2TS2-DF07R17LLA4X3-N1CS21/L417	5	NTN	
	52,000	12,000	0,08	51107	34	NTN-SNR	
	52,000	12,000	0,08	51107J	34	NTN	
	52,000	20,000	0,106	2J-DF07A64LLA4X-BCS33/L325	5	NTN	
	52,000	20,000	0,105	2J-DF07R10LLA4X-GCS28/L417	5	NTN	
	52,000	20,000	0,109	2TS2-DF07R21LLA4-GCS33/L417	5	NTN	
	55,000	10,000	0,08	6907	1	NTN	
	55,000	10,000	0,07	6907LLB	1	NTN	
	55,000	10,000	0,07	6907LLU	1	NTN	
	55,000	10,000	0,07	6907LU	1	NTN	
	55,000	10,000	0,07	6907NR	1-NR	NTN	
	55,000	10,000	0,07	6907XLLH	1	NTN	
	55,000	10,000	0,07	6907Z	1	NTN	
	55,000	10,000	0,07	6907ZZ	1	NTN	
	55,000	10,000	0,08	6907ZZNR	1-NR	NTN	
	55,000	10,000	0,09	7907	2	NTN	
	55,000	14,500	0,09	SF07A17	2	NTN	
	55,000	14,500	0,09	SF07A22	2	NTN	
	55,000	20,000	0,144	2J-DF07A02LLA4CS21/L417	5	NTN	
	55,000	20,000	0,144	2J-DF07A02LLA-N5CS30/L417	5	NTN	
	55,000	20,000	0,148	2TS2-DF0716LLBSCS47/2E	5	NTN	
	55,000	20,000	0,148	2TS2-DF0716LLHSCS35/L283	5	NTN	
	55,000	20,000	0,144	2TS2-DF0719LLX2CS35/L310	5	NTN	
	55,000	20,000	0,144	2TS2-DF0719LLX2CS35/L417	5	NTN	
	55,000	20,000	0,144	2TS2-DF0719LLX2-GCS35/L310	5	NTN	
	55,000	20,000	0,144	2TS2-DF07A02LLX2-GCS35/L417	5	NTN	
	55,000	20,000	0,149	DF0768LLU/2AS	5	NTN	
	56,400	14,000	0,10	SF0725	2	NTN	
	60,000	14,000	0,14	SC07B59	1	NTN	
	62,000	9,000	0,11	16007	1	NTN-SNR	
	62,000	14,000	0,16	6007	1	NTN-SNR	
	62,000	14,000	0,15	6007C	1	NTN	
	62,000	14,000	0,16	6007E	1	SNR	
62,000	14,000	0,16	6007EE	1	SNR		
62,000	14,000	0,15	6007F600	1	SNR		
62,000	14,000	0,16	6007F604	1	SNR		
62,000	14,000	0,16	6007FT150	1	SNR		
62,000	14,000	0,16	6007FT150ZZ	1	SNR		
62,000	14,000	0,16	6007HVZZ	1	SNR		
62,000	14,000	0,14	6007LB	1	NTN		
62,000	14,000	0,15	6007LLB	1	NTN		
62,000	14,000	0,16	6007LLBNR	1-NR	NTN		
62,000	14,000	0,15	6007LLU	1	NTN		

d	D	B	Kg	Reference			Brands
35,000	62,000	14,000	0,15	6007LLUN	1-NR	NTN	
	62,000	14,000	0,15	6007LLUNR	1-NR	NTN	
	62,000	14,000	0,16	6007LTZZ	1	SNR	
	62,000	14,000	0,15	6007LU	1	NTN	
	62,000	14,000	0,16	6007N	1-NR	SNR	
	62,000	14,000	0,16	6007NR	1-NR	NTN-SNR	
	62,000	14,000	0,16	6007NRZZ	1-NR	SNR	
	62,000	14,000	0,15	6007Z	1	NTN-SNR	
	62,000	14,000	0,15	6007ZNR	1-NR	NTN	
	62,000	14,000	0,15	6007ZZ	1	NTN-SNR	
	62,000	14,000	0,16	6007ZZNR	1-NR	NTN	
	62,000	14,000	0,29	6207LLU	1	NTN	
	62,000	14,000	0,17	7007	2	NTN	
	62,000	14,000	0,16	S60072RS	1	SNR	
	62,000	14,000	0,15	SSN007LL	1	NTN	
	62,000	14,000	0,15	SSN007ZZ	1	NTN	
	62,000	18,000	0,20	51207	34	NTN-SNR	
	62,000	19,000	0,23	SC07B26D2	1	NTN	
	62,000	20,000	0,22	63007EE	1	SNR	
	62,000	24,000	0,249	2TS2-DF07R12LLHA1CS33/L325	5	NTN	
	62,000	24,000	0,249	2TS2-DF07R12LLUCS35/L417	5	NTN	
	62,000	25,500	0,292	2J-DF07A52LA1X-GLRA-YCS38PX1/L453	5	NTN	
	62,000	25,500	0,292	A-2J-DF07A51LA1X-GLRA1-GCS38PX1/L453	5	NTN	
	62,000	25,500	0,292	A-2J-DF07A51LA1X-GLRA1-N1CS38PX1/LX1601	5	NTN	
	62,000	25,500	0,293	DF07A52LAX4-BLRA-BC-S38PX1/L453	5	NTN	
	62,000	28,000	0,35	7007DB	2	NTN	
	62,000	28,000	0,35	7007DF	2	NTN	
	62,000	28,000	0,35	7007DT	2	NTN	
	64,000	37,000	0,432	DF0766LLUACS32/5C	5	NTN	
	64,000	37,000	0,432	DF0766LLUACS32/L283	5	NTN	
	66,000	15,000	0,19	SC0790	1	NTN	
	66,000	15,000	0,19	SC07B66Z	1	NTN	
68,000	24,000	0,38	51307	34	NTN-SNR		
72,000	14,000	0,24	SC07B47	1	NTN		
72,000	16,000	0,26	SC07A04	1	NTN		
72,000	17,000	0,33	1207	6	SNR		
72,000	17,000	0,32	1207K	6	SNR		
72,000	17,000	0,32	1207S	6	NTN		
72,000	17,000	0,32	1207SK	6	NTN		
72,000	17,000	0,29	6207	1	NTN-SNR		
72,000	17,000	0,27	6207C	1	NTN		
72,000	17,000	0,28	6207CZ	1	NTN		
72,000	17,000	0,29	6207E	1	SNR		
72,000	17,000	0,30	6207EE	1	SNR		
72,000	17,000	0,28	6207F600	1	SNR		
72,000	17,000	0,30	6207F604	1	SNR		
72,000	17,000	0,29	6207F605	1	SNR		
72,000	17,000	0,30	6207FT150	1	SNR		
72,000	17,000	0,30	6207FT150ZZ	1	SNR		
72,000	17,000	0,29	6207HT200	1	SNR		
72,000	17,000	0,29	6207HT200ZZ	1	SNR		
72,000	17,000	0,28	6207HVZZ	1	SNR		
72,000	17,000	0,29	6207LB	1	NTN		
72,000	17,000	0,27	6207LLB	1	NTN		
72,000	17,000	0,29	6207LLBNR	1-NR	NTN		
72,000	17,000	0,29	6207LLH	1	NTN		
72,000	17,000	0,29	6207LLUNR	1-NR	NTN		
72,000	17,000	0,28	6207LU	1	NTN		
72,000	17,000	0,28	6207N	1-NR	NTN-SNR		
72,000	17,000	0,29	6207NEE	1-NR	SNR		
72,000	17,000	0,29	6207NR	1-NR	NTN-SNR		
72,000	17,000	0,29	6207NREE	1-NR	SNR		

										Brands	
d	D	B	Kg	Reference							
35,000	72,000	17,000	0,29	6207NRZ	1-NR	SNR					
	72,000	17,000	0,31	6207NRZZ	1-NR	SNR					
	72,000	17,000	0,28	6207Z	1	NTN-SNR					
	72,000	17,000	0,28	6207ZNR	1-NR	NTN					
	72,000	17,000	0,27	6207ZZ	1	NTN-SNR					
	72,000	17,000	0,29	6207ZZNR	1-NR	NTN					
	72,000	17,000	0,28	7207	2	NTN-SNR					
	72,000	17,000	0,28	7207B	2	NTN					
	72,000	17,000	0,29	7207BG	2	NTN					
	72,000	17,000	0,29	7207BGA	2	SNR					
	72,000	17,000	0,29	CS207(6207SEE)	12	SNR					
	72,000	17,000	0,29	CS207LLU	12	NTN					
	72,000	17,000	0,27	F-6207LLU	1	NTN					
	72,000	17,000	0,28	S62072RS	1	SNR					
	72,000	17,000	0,29	SF07A88	2	NTN					
	72,000	17,000	0,27	SSN207ZZ	1	NTN					
	72,000	21,000	0,29	8507	1	NTN					
	72,000	21,000	0,34	87507	1	NTN					
	72,000	21,000	0,417	DF07A74CS16	5	NTN					
	72,000	23,000	0,41	2207	6	SNR					
	72,000	23,000	0,42	2207EEG15	6	SNR					
	72,000	23,000	0,40	2207K	6	SNR					
	72,000	23,000	0,46	2207KEEG15	6	SNR					
	72,000	23,000	0,38	2207S	6	NTN					
	72,000	23,000	0,38	2207SK	6	NTN					
	72,000	23,000	0,41	4207A	4	SNR					
	72,000	23,000	0,40	62207EE	1	SNR					
	72,000	25,000	0,33	88507	1	NTN					
	72,000	26,000	0,33	SX07B65LLU	2	NTN					
	72,000	26,987	0,44	63207LLB	1	NTN					
	72,000	26,987	0,44	63207LLU	1	NTN					
	72,000	26,987	0,44	63207ZZ	1	NTN					
	72,000	27,000	0,49	3207B	5	SNR					
	72,000	27,000	0,45	5207EEG15	5	SNR					
	72,000	27,000	0,46	5207NRZZG15	5-NR	SNR					
	72,000	27,000	0,43	5207S	5	NTN					
	72,000	27,000	0,43	5207SCLLD	5	NTN					
	72,000	27,000	0,43	5207SCLLM	5	NTN					
	72,000	27,000	0,43	5207SCZZ	5	NTN					
	72,000	27,000	0,46	5207ZZG15	5	SNR					
	72,000	28,000	0,469	DF07A36	5	NTN					
	72,000	33,000	0,37	SX0768LLU	2	NTN					
	72,000	33,500	0,571	A-2J-DF07A68LA1-GLRAXC-S46PX1/LX16Q1	5	NTN					
	72,000	34,000	0,57	6207D2	1	NTN					
	72,000	34,000	0,58	7207BDB	2	NTN					
	72,000	34,000	0,58	7207BDF	2	NTN					
	72,000	34,000	0,35	7207DB	2	NTN					
	72,000	34,000	0,57	7207DT	2	NTN					
	72,000	35,000	0,58	SX0772LLU	2	NTN					
	72,000	44,000	0,33	SX0773LLU	2	NTN					
	72,000	17/52	0,54	11207G15	6	SNR					
	72,000	32/17	0,42	CUS207	15	SNR					
	72,000	32/17	0,42	US207G2	10	SNR					
	72,000	34/17	0,37	AS207D1	10	NTN					
72,000	34/17	0,49	ASS207N	15	NTN						
72,000	38,9/25,4	0,49	AEL207D1	11	NTN						
72,000	38,9/25,4	0,49	AELS207N	16	NTN						
72,000	38,9/25,4	0,50	CES207	16	SNR						
72,000	38,9/25,4	0,50	ES207G2	11	SNR						
72,000	42,9/20	0,47	CUC207	13	SNR						
72,000	42,9/20	0,49	UC207	7	NTN-SNR						
72,000	42,9/20	0,49	UCS207LD1N	13	NTN						

										Brands	
d	D	B	Kg	Reference							
35,000	72,000	51,1/37,6	0,60	CEX207	14	SNR					
	72,000	51,1/37,6	0,60	EX207G2	8	SNR					
	72,000	51,1/37,6	0,60	UEL207D1	8	NTN					
	72,000	51,1/37,6	0,60	UELS207LD1N	14	NTN					
	75,000	25,000	0,67	SX07D68LLU	2	NTN					
	80,000	21,000	0,50	1307G15	6	SNR					
	80,000	21,000	0,50	1307KG15	6	SNR					
	80,000	21,000	0,51	1307S	6	NTN					
	80,000	21,000	0,51	1307SK	6	NTN					
	80,000	21,000	0,46	6307	1	NTN-SNR					
	80,000	21,000	0,46	6307E	1	SNR					
	80,000	21,000	0,46	6307EE	1	SNR					
	80,000	21,000	0,46	6307FT150	1	SNR					
	80,000	21,000	0,45	6307FT150ZZ	1	SNR					
	80,000	21,000	0,48	6307HT200	1	SNR					
	80,000	21,000	0,47	6307HT200ZZ	1	SNR					
	80,000	21,000	0,45	6307LB	1	NTN					
	80,000	21,000	0,45	6307LLB	1	NTN					
	80,000	21,000	0,47	6307LLBNR	1-NR	NTN					
	80,000	21,000	0,46	6307LLH	1	NTN					
	80,000	21,000	0,46	6307LLU	1	NTN					
	80,000	21,000	0,46	6307LLUN	1-NR	NTN					
	80,000	21,000	0,47	6307LLUNR	1-NR	NTN					
	80,000	21,000	0,45	6307LU	1	NTN					
	80,000	21,000	0,45	6307N	1-NR	NTN-SNR					
	80,000	21,000	0,46	6307NR	1-NR	NTN-SNR					
	80,000	21,000	0,48	6307NREE	1-NR	SNR					
	80,000	21,000	0,45	6307NRZ	1-NR	SNR					
	80,000	21,000	0,45	6307NRZZ	1-NR	SNR					
	80,000	21,000	0,45	6307Z	1	NTN-SNR					
	80,000	21,000	0,46	6307ZNR	1-NR	NTN					
	80,000	21,000	0,46	6307ZZ	1	NTN-SNR					
	80,000	21,000	0,47	6307ZZNR	1-NR	NTN					
	80,000	21,000	0,46	7307	2	NTN					
	80,000	21,000	0,47	7307B	2	NTN					
	80,000	21,000	0,46	7307BA	2	SNR					
	80,000	21,000	0,46	7307BG	2	NTN					
	80,000	21,000	0,46	7307BGA	2	SNR					
	80,000	21,000	0,49	CS307LLU	12	NTN					
	80,000	21,000	0,58	QJ307MA	3	SNR					
	80,000	31,000	0,72	2307EEG15	6	SNR					
	80,000	31,000	0,66	2307G15	6	SNR					
	80,000	31,000	0,65	2307KG15	6	SNR					
	80,000	31,000	0,64	2307S	6	NTN					
	80,000	31,000	0,64	2307SK	6	NTN					
	80,000	31,000	0,70	4307A	4	SNR					
	80,000	31,000	0,66	62307EE	1	SNR					
	80,000	32,000	0,76	51407	34	NTN-SNR					
	80,000	34,900	0,80	3307B	5	SNR					
	80,000	34,900	0,75	5307EEG15	5	SNR					
	80,000	34,900	0,84	5307NRZZG15	5-NR	SNR					
	80,000	34,900	0,79	5307S	5	NTN					
	80,000	34,900	0,79	5307SCLLD	5	NTN					
	80,000	34,900	0,79	5307SCLLM	5	NTN					
80,000	34,900	0,79	5307SCZZ	5	NTN						
80,000	34,900	0,74	5307ZZG15	5	SNR						
80,000	34,900	0,75	63307LLB	1	NTN						
80,000	34,900	0,75	63307LLU	1	NTN						
80,000	34,900	0,75	63307ZZ	1	NTN						
80,000	35,000	0,60	6307ZZK+H307X	1	NTN						
80,000	42,000	0,92	6307ZZD2	1	NTN						
80,000	42,000	0,93	7307BDB	2	NTN						

								Brands		
d	D	B	Kg	Reference						
35,000	80,000	42,000	0,93	7307BDF	2	NTN				
	80,000	42,000	0,94	7307BDT	2	NTN				
	80,000	42,000	0,93	7307DB	2	NTN				
	80,000	42,000	0,93	7307DF	2	NTN				
	80,000	33/25	0,75	UK307D1	9	NTN				
	80,000	48/25	0,71	UC307	7	NTN-SNR				
	80,000	48/25	0,74	UCS307D1	13	NTN				
	80,000	49,2/21	0,82	UCX07	7	NTN				
	80,000	51,6/38,1	0,80	EX307G2	8	SNR				
	80,000	51,6/38,1	0,80	UEL307D1	8	NTN				
	80,000	51,6/38,1	0,83	UELS307D1N	14	NTN				
	82,000	27,000	0,58	SX0730LL	2	NTN				
	82,300	27,099	0,61	SX07A25LLU	2	NTN				
	88,000	25,000	0,60	SX0702LLU	2	NTN				
	90,000	35/28	1,03	UK308G2H	9	SNR				
	91,000	30,000	0,70	SX071LLU	2	NTN				
	100,000	25,000	0,95	6407	1	NTN-SNR				
	100,000	25,000	0,96	6407Z	1	NTN				
	100,000	25,000	0,96	6407ZZ	1	NTN				
	100,000	25,000	1,10	7407	2	NTN				
	100,000	25,000	1,10	7407B	2	NTN				
	100,000	25,000	1,10	7407BG	2	NTN				
	101,350	28,580	1,26	SX07E20LLU	2	NTN				
	111,000	36,000	1,55	SX073LLU	2	NTN				
	118,000	30,000	1,53	SX072LLU	2	NTN				
	120,000	30,400	1,50	SX07C02LLU	2	NTN				
	35,700	55,000	15,000	0,18	SX07B98LZ	2	NTN			
	36,000	62,000	9,000	0,11	16007/36	1	NTN			
	36,100	55,000	10,000	0,07	6907LLB/361	1	NTN			
	36,443	52,000	10,000	0,04	SE0725	2	NTN			
	38,000	58,000	15,000	0,11	SC0889LL	1	NTN			
	38,100	47,620	4,760	0,02	KYS015	2	NTN			
67,000		16,400	0,19	SF0816	2	NTN				
38,892	77,762	19,710	0,36	SX0860LLU	2	NTN				
40,000	50,000	6,000	0,02	6708	1	NTN				
	52,000	7,000	0,03	6808	1	NTN				
	52,000	7,000	0,03	6808LB	1	NTN				
	52,000	7,000	0,03	6808LLB	1	NTN				
	52,000	7,000	0,03	6808LLU	1	NTN				
	52,000	7,000	0,03	6808ZZ	1	NTN				
	52,000	7,000	0,03	6808ZZNR	1-NR	NTN				
	60,000	13,000	0,12	51108	34	NTN-SNR				
	62,000	12,000	0,11	6908	1	NTN				
	62,000	12,000	0,11	6908LLB	1	NTN				
	62,000	12,000	0,11	6908LLH	1	NTN				
	62,000	12,000	0,11	6908LLU	1	NTN				
	62,000	12,000	0,11	6908LU	1	NTN				
	62,000	12,000	0,11	6908NR	1-NR	NTN				
	62,000	12,000	0,11	6908Z	1	NTN				
	62,000	12,000	0,11	6908ZZ	1	NTN				
	62,000	12,000	0,11	6908ZZNR	1-NR	NTN				
	62,000	12,000	0,13	7908	2	NTN				
	62,000	20,638	0,190	2TS2-DF0863LLACS56/5C	5	NTN				
	62,000	20,638	0,190	2TS2-DF0863LLHCS30/L310	5	NTN				

								Brands	
d	D	B	Kg	Reference					
40,000	62,000	24,000	0,214	2TS2-DF0865LLBCS45/5C	5	NTN			
	63,600	16,000	0,15	SF0815	2	NTN			
	66,000	24,000	0,250	2TS2-DF08A18LLCS27/L417	5	NTN			
	67,000	20,000	0,25	SF0859	2	NTN			
	68,000	9,000	0,13	16008	1	NTN-SNR			
	68,000	15,000	0,19	6008	1	NTN-SNR			
	68,000	15,000	0,19	6008E	1	SNR			
	68,000	15,000	0,20	6008EE	1	SNR			
	68,000	15,000	0,19	6008F600	1	SNR			
	68,000	15,000	0,20	6008FT150	1	SNR			
	68,000	15,000	0,19	6008FT150ZZ	1	SNR			
	68,000	15,000	0,20	6008HT200	1	SNR			
	68,000	15,000	0,18	6008HVZZ	1	SNR			
	68,000	15,000	0,18	6008LB	1	NTN			
	68,000	15,000	0,19	6008LLB	1	NTN			
	68,000	15,000	0,18	6008LLBN	1-NR	NTN			
	68,000	15,000	0,20	6008LLBNR	1-NR	NTN			
	68,000	15,000	0,18	6008LLU	1	NTN			
	68,000	15,000	0,19	6008LLUNR	1-NR	NTN			
	68,000	15,000	0,18	6008LU	1	NTN			
	68,000	15,000	0,19	6008LUZ	1	NTN			
	68,000	15,000	0,19	6008N	1-NR	NTN			
	68,000	15,000	0,20	6008NR	1-NR	NTN-SNR			
	68,000	15,000	0,19	6008NRZZ	1-NR	SNR			
	68,000	15,000	0,18	6008Z	1	NTN-SNR			
	68,000	15,000	0,19	6008ZNR	1-NR	NTN			
	68,000	15,000	0,19	6008ZZ	1	NTN-SNR			
	68,000	15,000	0,19	6008ZZNR	1-NR	NTN			
	68,000	15,000	0,22	7008	2	NTN			
	68,000	15,000	0,18	F-6008J1LLU	1	NTN			
	68,000	15,000	0,19	S60082RS	1	SNR			
	68,000	15,000	0,18	SSN008ZZ	1	NTN			
	68,000	19,000	0,26	51208	34	NTN-SNR			
	68,000	21,000	0,26	63008EE	1	SNR			
	68,000	30,000	0,42	6008ZD2	1	NTN			
	68,000	30,000	0,42	7008DB	2	NTN			
	68,000	30,000	0,42	7008DF	2	NTN			
	68,000	30,000	0,42	7008DT	2	NTN			
	74,000	19,000	0,29	SF0820	2	NTN			
	74,000	41,000	0,31	SX088LLB	2	NTN			
	78,000	26,000	0,53	51308	34	NTN-SNR			
	80,000	16,500	0,34	SC08A80	1	NTN			
	80,000	16,500	0,35	SC08A92	1	NTN			
	80,000	18,000	0,43	1208	6	SNR			
	80,000	18,000	0,42	1208K	6	SNR			
	80,000	18,000	0,42	1208S	6	NTN			
	80,000	18,000	0,42	1208SK	6	NTN			
	80,000	18,000	0,36	6208	1	NTN-SNR			
	80,000	18,000	0,42	6208E	1	SNR			
	80,000	18,000	0,38	6208EE	1	SNR			
	80,000	18,000	0,35	6208F600	1	SNR			
	80,000	18,000	0,36	6208F604	1	SNR			
80,000	18,000	0,35	6208F605	1	SNR				
80,000	18,000	0,38	6208FT150	1	SNR				
80,000	18,000	0,36	6208FT150ZZ	1	SNR				
80,000	18,000	0,37	6208HT200	1	SNR				
80,000	18,000	0,38	6208HT200ZZ	1	SNR				
80,000	18,000	0,35	6208HVZZ	1	SNR				
80,000	18,000	0,37	6208KEE	1	SNR				
80,000	18,000	0,36	6208LB	1	NTN				
80,000	18,000	0,36	6208LH	1	NTN				
80,000	18,000	0,36	6208LHA	1	NTN				

								Brands	
d	D	B	Kg	Reference					
40,000	80,000	18,000	0,37	6208LLB	1	NTN			
	80,000	18,000	0,38	6208LLBNR	1-NR	NTN			
	80,000	18,000	0,37	6208LLH	1	NTN			
	80,000	18,000	0,36	6208LLU	1	NTN			
	80,000	18,000	0,36	6208LLUK	1	NTN			
	80,000	18,000	0,36	6208LLUN	1-NR	NTN			
	80,000	18,000	0,36	6208LLUNR	1-NR	NTN			
	80,000	18,000	0,36	6208LU	1	NTN			
	80,000	18,000	0,36	6208N	1-NR	NTN-SNR			
	80,000	18,000	0,37	6208NR	1-NR	NTN-SNR			
	80,000	18,000	0,39	6208NREE	1-NR	SNR			
	80,000	18,000	0,38	6208NRZ	1-NR	SNR			
	80,000	18,000	0,39	6208NRZZ	1-NR	SNR			
	80,000	18,000	0,36	6208Z	1	NTN-SNR			
	80,000	18,000	0,35	6208ZNR	1-NR	NTN			
	80,000	18,000	0,36	6208ZZ	1	NTN-SNR			
	80,000	18,000	0,37	6208ZZD22	1	SNR			
	80,000	18,000	0,38	6208ZZNR	1-NR	NTN			
	80,000	18,000	0,36	7208	2	NTN			
	80,000	18,000	0,38	7208B	2	NTN			
	80,000	18,000	0,38	7208BA	2	SNR			
	80,000	18,000	0,36	7208BG	2	NTN			
	80,000	18,000	0,38	7208BGA	2	SNR			
	80,000	18,000	0,42	7208BGM	2	SNR			
	80,000	18,000	0,37	CS208(6208SEE)	12	SNR			
	80,000	18,000	0,37	CS208LLU	12	NTN			
	80,000	18,000	0,37	S62082RS	1	SNR			
	80,000	18,000	0,37	SF08A67	2	NTN			
	80,000	18,000	0,36	SSN208LL	1	NTN			
	80,000	18,000	0,36	SSN208ZZ	1	NTN			
	80,000	23,000	0,51	2208EEG15	6	SNR			
	80,000	23,000	0,48	2208G15	6	SNR			
	80,000	23,000	0,50	2208KEEG15	6	SNR			
	80,000	23,000	0,47	2208KG15	6	SNR			
	80,000	23,000	0,48	2208S	6	NTN			
	80,000	23,000	0,48	2208SK	6	NTN			
	80,000	23,000	0,51	4208A	4	SNR			
	80,000	23,000	0,47	62208EE	1	SNR			
	80,000	27,000	0,47	88508	1	NTN			
	80,000	30,162	0,60	63208LLB	1	NTN			
	80,000	30,162	0,60	63208ZZ	1	NTN			
	80,000	30,200	0,65	3208B	5	SNR			
	80,000	30,200	0,60	5208EEG15	5	SNR			
	80,000	30,200	0,62	5208NRZZG15	5-NR	SNR			
	80,000	30,200	0,57	5208S	5	NTN			
	80,000	30,200	0,57	5208SCLLD	5	NTN			
	80,000	30,200	0,57	5208SCLLM	5	NTN			
	80,000	30,200	0,57	5208SCZZ	5	NTN			
	80,000	30,200	0,59	5208ZZG15	5	SNR			
	80,000	30,200	0,60	63208LLU	1	NTN			
	80,000	36,000	0,73	6208D2	1	NTN			
	80,000	36,000	0,74	6208LLUD2	1	NTN			
	80,000	36,000	0,75	7208BDB	2	NTN			
	80,000	36,000	0,75	7208BDF	2	NTN			
	80,000	36,000	0,75	7208BDT	2	NTN			
	80,000	36,000	0,71	7208DB	2	NTN			
	80,000	36,000	0,74	7208DF	2	NTN			
	80,000	36,000	0,71	7208DT	2	NTN			
	80,000	18/56	0,72	11208G15	6	SNR			
	80,000	34/18	0,48	CUS208	15	SNR			
80,000	34/18	0,60	US208G2	10	SNR				
80,000	38/18	0,50	AS208D1	10	NTN				

								Brands	
d	D	B	Kg	Reference					
40,000	80,000	38/18	0,50	ASS208N	15	NTN			
	80,000	43,7/30,2	0,66	AEL208D1	11	NTN			
	80,000	43,7/30,2	0,66	AELS208N	16	NTN			
	80,000	43,7/30,2	0,65	CES208	16	SNR			
	80,000	43,7/30,2	0,65	ES208G2	11	SNR			
	80,000	49,2/21	0,64	CUC208	13	SNR			
	80,000	49,2/21	0,65	UC208	7	NTN-SNR			
	80,000	49,2/21	0,65	UCS208LD1N	13	NTN			
	80,000	56,3/42,8	0,78	CEX208	14	SNR			
	80,000	56,3/42,8	0,78	EX208G2	8	SNR			
	80,000	56,3/42,8	0,79	UEL208D1	8	NTN			
	80,000	56,3/42,8	0,79	UELS208LD1N	14	NTN			
	84,000	19,000	0,46	SC08A93	1	NTN			
	85,000	30/22	0,81	UK209G2H	9	SNR			
	85,000	49,2/22	0,93	UCX08	7	NTN			
	90,000	20,000	0,57	SC0828	1	NTN			
	90,000	23,000	0,72	1308	6	SNR			
	90,000	23,000	0,72	1308K	6	SNR			
	90,000	23,000	0,72	1308S	6	NTN			
	90,000	23,000	0,72	1308SK	6	NTN			
	90,000	23,000	0,63	6308	1	NTN-SNR			
	90,000	23,000	0,64	6308E	1	SNR			
	90,000	23,000	0,64	6308EE	1	SNR			
	90,000	23,000	0,63	6308FT150	1	SNR			
	90,000	23,000	0,61	6308FT150ZZ	1	SNR			
	90,000	23,000	0,65	6308HT200	1	SNR			
	90,000	23,000	0,65	6308HT200ZZ	1	SNR			
	90,000	23,000	0,63	6308HVZZ	1	SNR			
	90,000	23,000	0,62	6308LB	1	NTN			
	90,000	23,000	0,60	6308LH	1	NTN			
	90,000	23,000	0,61	6308LLB	1	NTN			
	90,000	23,000	0,65	6308LLBNR	1-NR	NTN			
	90,000	23,000	0,64	6308LLH	1	NTN			
	90,000	23,000	0,64	6308LLU	1	NTN			
	90,000	23,000	0,60	6308LLUNR	1-NR	NTN			
	90,000	23,000	0,63	6308LU	1	NTN			
	90,000	23,000	0,75	6308LUNR	1-NR	NTN			
	90,000	23,000	0,62	6308N	1-NR	NTN-SNR			
	90,000	23,000	0,65	6308NR	1-NR	NTN-SNR			
	90,000	23,000	0,61	6308NREE	1-NR	SNR			
	90,000	23,000	0,61	6308NRZ	1-NR	SNR			
	90,000	23,000	0,67	6308NRZZ	1-NR	SNR			
	90,000	23,000	0,62	6308Z	1	NTN-SNR			
	90,000	23,000	0,64	6308ZNR	1-NR	NTN			
	90,000	23,000	0,61	6308ZZ	1	NTN-SNR			
	90,000	23,000	0,65	6308ZZNR	1-NR	NTN			
	90,000	23,000	0,69	7308	2	NTN			
	90,000	23,000	0,64	7308B	2	NTN			
	90,000	23,000	0,31	7308BA	2	SNR			
	90,000	23,000	0,64	7308BG	2	NTN			
	90,000	23,000	0,63	7308BGA	2	SNR			
	90,000	23,000	0,69	7308BGM	2	SNR			
	90,000	23,000	1,39	7308DB	2	NTN			
	90,000	23,000	0,62	CS308(6308SEE)	12	SNR			
	90,000	23,000	0,62	CS308LLU	12	NTN			
	90,000	23,000	0,600	QJ308	3	NTN			
	90,000	23,000	0,77	QJ308MA	3	SNR			
	90,000	23,000	0,58	SX08A50	2	NTN			
	90,000	33,000	1,05	2308EEG15	6	SNR			
	90,000	33,000	0,92	2308G15	6	SNR			
90,000	33,000	0,95	2308K	6	SNR				
90,000	33,000	0,90	2308KG15	6	SNR				

										Brands		
d	D	B	Kg	Reference								
40,000	90,000	33,000	0,89	2308S	6	NTN						
	90,000	33,000	0,89	2308SK	6	NTN						
	90,000	33,000	0,93	4308A	4	SNR						
	90,000	33,000	0,90	62308EE	1	SNR						
	90,000	36,000	1,09	51408	34	NTN						
	90,000	36,500	1,06	3308B	5	SNR						
	90,000	36,500	1,00	5308EEG15	5	SNR						
	90,000	36,500	1,02	5308NRZG15	5-NR	SNR						
	90,000	36,500	1,05	5308S	5	NTN						
	90,000	36,500	1,05	5308SCLLD	5	NTN						
	90,000	36,500	1,05	5308SCLLM	5	NTN						
	90,000	36,500	1,05	5308SCZZ	5	NTN						
	90,000	36,500	1,01	5308ZG15	5	SNR						
	90,000	36,500	0,99	63308LLB	1	NTN						
	90,000	36,500	0,99	63308LLU	1	NTN						
	90,000	36,500	0,99	63308ZZ	1	NTN						
	90,000	46,000	1,27	6308ZZD2	1	NTN						
	90,000	46,000	1,28	7308BDB	2	NTN						
	90,000	46,000	1,28	7308BDF	2	NTN						
	90,000	46,000	1,28	7308DF	2	NTN						
	90,000	23/58	1,08	11308G15	6	SNR						
	90,000	34/27	1,02	UK308D1	9	NTN						
	90,000	52/27	0,96	UC308D1	7	NTN						
	90,000	52/27	1,00	UCS308D1	13	NTN						
	90,000	52/28	0,96	UC308G2	7	SNR						
	90,000	57,1/41,3	1,08	EX308G2	8	SNR						
	90,000	57,1/41,3	1,08	UEL308D1	8	NTN						
	90,000	57,1/41,3	1,12	UELS308D1N	14	NTN						
	100,000	23,000	0,58	SX08A05	2	NTN						
	100,000	25,000	0,88	6309/40	1	NTN						
	100,000	38/30	1,47	UK309G2H	9	SNR						
	110,000	27,000	1,23	6408	1	NTN-SNR						
	110,000	27,000	1,26	6408NR	1-NR	NTN						
	110,000	27,000	1,25	6408ZZ	1	NTN						
	110,000	27,000	1,35	7408	2	NTN						
	110,000	27,000	1,39	7408B	2	NTN						
	110,000	27,000	1,39	7408BG	2	NTN						
	110,000	27,000	1,39	7408BDB	2	NTN						
	110,000	54,000	2,78	7408BDB	2	NTN						
	118,000	37,000	1,65	SX087LLU	2	NTN						
	42,000	70,000	11,000	0,15	SC0890	1	NTN					
	43,000	68,000	13,000	0,15	SC0929	1	NTN					
	45,000	58,000	7,000	0,03	6809	1	NTN					
		58,000	7,000	0,03	6809LLB	1	NTN					
		58,000	7,000	0,04	6809LLU	1	NTN					
		58,000	7,000	0,03	6809Z	1	NTN					
		58,000	7,000	0,03	6809ZZ	1	NTN					
		58,000	14,000	0,08	6809D2	1	NTN					
65,000		14,000	0,14	51109	34	NTN-SNR						
68,000		12,000	0,14	6909	1	NTN						
68,000		12,000	0,13	6909LLB	1	NTN						
68,000		12,000	0,13	6909LLU	1	NTN						
68,000		12,000	0,13	6909LU	1	NTN						
68,000		12,000	0,13	6909Z	1	NTN						
68,000		12,000	0,14	6909ZZ	1	NTN						
68,000		12,000	0,14	6909ZNR	1-NR	NTN						
68,000		12,000	0,15	7909	2	NTN						
68,000		12,000	0,14	SF0990	2	NTN						
68,000		19,000	0,21	SC0989D2	1	NTN						
68,000		20,638	0,222	2TS2-DF0954LLHA1CS67/2E	5	NTN						

										Brands	
d	D	B	Kg	Reference							
45,000	68,000	24,000	0,27	6909D2	1	NTN					
	73,000	20,000	0,32	51209	34	NTN-SNR					
	74,000	18,000	0,22	SF0914	2	NTN					
	75,000	10,000	0,17	16009	1	NTN-SNR					
	75,000	16,000	0,24	6009	1	NTN-SNR					
	75,000	16,000	0,25	6009E	1	SNR					
	75,000	16,000	0,25	6009EE	1	SNR					
	75,000	16,000	0,25	6009FT150	1	SNR					
	75,000	16,000	0,25	6009FT150ZZ	1	SNR					
	75,000	16,000	0,24	6009HVZZ	1	SNR					
	75,000	16,000	0,24	6009LB	1	NTN					
	75,000	16,000	0,24	6009LLB	1	NTN					
	75,000	16,000	0,25	6009LLBNR	1-NR	NTN					
	75,000	16,000	0,24	6009LLU	1	NTN					
	75,000	16,000	0,24	6009LLUN	1-NR	NTN					
	75,000	16,000	0,25	6009LLUNR	1-NR	NTN					
	75,000	16,000	0,24	6009LU	1	NTN					
	75,000	16,000	0,24	6009N	1-NR	NTN					
	75,000	16,000	0,25	6009NR	1-NR	NTN-SNR					
	75,000	16,000	0,23	6009Z	1	NTN-SNR					
	75,000	16,000	0,24	6009ZNR	1-NR	NTN					
	75,000	16,000	0,21	6009ZZ	1	NTN-SNR					
	75,000	16,000	0,24	6009ZZNR	1-NR	NTN					
	75,000	16,000	0,27	7009	2	NTN					
	75,000	32,000	0,54	7009DB	2	NTN					
	75,400	21,200	0,37	45TAG12	34	NTN					
	77,000	22,000	0,29	SF0937	2	NTN					
	85,000	11,000	0,27	SC0922	1	NTN					
	85,000	19,000	0,47	1209	6	SNR					
	85,000	19,000	0,46	1209K	6	SNR					
	85,000	19,000	0,47	1209S	6	NTN					
	85,000	19,000	0,47	1209SK	6	NTN					
	85,000	19,000	0,26	6010LLU	1	NTN					
	85,000	19,000	0,40	6209	1	NTN-SNR					
	85,000	19,000	0,42	6209E	1	SNR					
	85,000	19,000	0,41	6209EE	1	SNR					
	85,000	19,000	0,41	6209F604	1	SNR					
	85,000	19,000	0,41	6209FT150	1	SNR					
	85,000	19,000	0,43	6209FT150ZZ	1	SNR					
	85,000	19,000	0,42	6209HT200	1	SNR					
	85,000	19,000	0,42	6209HT200ZZ	1	SNR					
	85,000	19,000	0,41	6209HVZZ	1	SNR					
	85,000	19,000	0,40	6209K	1	SNR					
	85,000	19,000	0,40	6209KEE	1	SNR					
	85,000	19,000	0,39	6209LB	1	NTN					
	85,000	19,000	0,40	6209LLB	1	NTN					
	85,000	19,000	0,41	6209LLBNR	1-NR	NTN					
	85,000	19,000	0,40	6209LLU	1	NTN					
	85,000	19,000	0,41	6209LLUNR	1-NR	NTN					
	85,000	19,000	0,39	6209LU	1	NTN					
	85,000	19,000	0,40	6209N	1-NR	SNR					
85,000	19,000	0,41	6209NR	1-NR	NTN-SNR						
85,000	19,000	0,43	6209NREE	1-NR	SNR						
85,000	19,000	0,41	6209NRZ	1-NR	SNR						
85,000	19,000	0,42	6209NRZZ	1-NR	SNR						
85,000	19,000	0,41	6209SEE	1	SNR						
85,000	19,000	0,39	6209Z	1	NTN-SNR						
85,000	19,000	0,40	6209ZNR	1-NR	NTN						
85,000	19,000	0,40	6209ZZ	1	NTN-SNR						
85,000	19,000	0,41	6209ZZNR	1-NR	NTN						
85,000	19,000	0,40	7209	2	NTN						
85,000	19,000										

										Brands	
d	D	B	Kg	Reference							
45,000	85,000	19,000	0,42	7209BA	2	SNR					
	85,000	19,000	0,41	7209BG	2	NTN					
	85,000	19,000	0,42	7209BGA	2	SNR					
	85,000	19,000	0,47	7209BGM	2	SNR					
	85,000	19,000	0,40	CS209(6209SEE)	12	SNR					
	85,000	19,000	0,40	CS209LLU	12	NTN					
	85,000	19,000	0,41	SSN209LL	1	NTN					
	85,000	23,000	0,56	2209	6	SNR					
	85,000	23,000	0,54	2209EEG15	6	SNR					
	85,000	23,000	0,55	2209K	6	SNR					
	85,000	23,000	0,53	2209KEEG15	6	SNR					
	85,000	23,000	0,52	2209S	6	NTN					
	85,000	23,000	0,52	2209SK	6	NTN					
	85,000	23,000	0,56	4209A	4	SNR					
	85,000	23,000	0,49	62209EE	1	SNR					
	85,000	27,000	0,49	88509	1	NTN					
	85,000	28,000	0,67	51309	34	NTN-SNR					
	85,000	30,162	0,63	63209LLB	1	NTN					
	85,000	30,162	0,63	63209LLU	1	NTN					
	85,000	30,162	0,63	63209ZZ	1	NTN					
	85,000	30,200	0,66	3209A	5	SNR					
	85,000	30,200	0,64	5209EEG15	5	SNR					
	85,000	30,200	0,71	5209NRZG15	5-NR	SNR					
	85,000	30,200	0,62	5209S	5	NTN					
	85,000	30,200	0,65	5209ZZG15	5	SNR					
	85,000	38,000	0,80	6209LLUD2	1	NTN					
	85,000	38,000	0,81	7209BDB	2	NTN					
	85,000	38,000	0,81	7209BDF	2	NTN					
	85,000	38,000	0,81	7209DB	2	NTN					
	85,000	38,000	0,81	7209DF	2	NTN					
	85,000	19/58	0,79	11209G15	6	SNR					
	85,000	41,2/19	0,57	CUS209	15	SNR					
	85,000	41,2/19	0,65	US209G2	10	SNR					
	85,000	43,7/30,2	0,69	CES209	16	SNR					
	85,000	43,7/30,2	0,69	ES209G2	11	SNR					
	85,000	49,2/22	0,68	CUC209	13	SNR					
	85,000	49,2/22	0,70	UC209	7	NTN-SNR					
	85,000	49,2/22	0,70	UCS209LD1N	13	NTN					
	85,000	56,3/42,8	0,87	CEX209	14	SNR					
	85,000	56,3/42,8	0,87	EX209G2	8	SNR					
	85,000	56,3/42,8	0,85	UEL209D1	8	NTN					
	85,000	56,3/42,8	0,85	UELS209LD1N	14	NTN					
	90,000	31/23	0,95	UK210G2H	9	SNR					
	90,000	51,6/24	1,00	UCX09	7	NTN					
	100,000	21,000	0,72	SC0914	1	NTN					
	100,000	21,000	0,70	SC0915	1	NTN					
	100,000	25,000	0,98	1309	6	SNR					
	100,000	25,000	0,97	1309K	6	SNR					
	100,000	25,000	0,96	1309S	6	NTN					
	100,000	25,000	0,96	1309SK	6	NTN					
100,000	25,000	0,81	6309	1	NTN-SNR						
100,000	25,000	0,86	6309E	1	SNR						
100,000	25,000	0,87	6309EE	1	SNR						
100,000	25,000	0,83	6309F600	1	SNR						
100,000	25,000	0,83	6309F603	1	SNR						
100,000	25,000	0,86	6309FT150	1	SNR						
100,000	25,000	0,85	6309FT150ZZ	1	SNR						
100,000	25,000	0,86	6309HT200	1	SNR						
100,000	25,000	0,86	6309HT200ZZ	1	SNR						
100,000	25,000	0,86	6309KEE	1	SNR						
100,000	25,000	0,81	6309LB	1	NTN						
100,000	25,000	0,80	6309LLB	1	NTN						

										Brands	
d	D	B	Kg	Reference							
45,000	100,000	25,000	0,85	6309LLBNR	1-NR	NTN					
	100,000	25,000	0,83	6309LLH	1	NTN					
	100,000	25,000	0,83	6309LLU	1	NTN					
	100,000	25,000	0,82	6309LLUNR	1-NR	NTN					
	100,000	25,000	0,80	6309LU	1	NTN					
	100,000	25,000	0,84	6309N	1-NR	SNR					
	100,000	25,000	0,83	6309NR	1-NR	NTN-SNR					
	100,000	25,000	0,88	6309NREE	1-NR	SNR					
	100,000	25,000	0,83	6309NRZ	1-NR	SNR					
	100,000	25,000	0,83	6309NRZZ	1-NR	SNR					
	100,000	25,000	0,83	6309SEE	1	SNR					
	100,000	25,000	0,80	6309Z	1	NTN-SNR					
	100,000	25,000	0,82	6309ZNR	1-NR	NTN					
	100,000	25,000	0,79	6309ZZ	1	NTN-SNR					
	100,000	25,000	0,84	6309ZZNR	1-NR	NTN					
	100,000	25,000	0,84	7309	2	NTN					
	100,000	25,000	0,85	7309B	2	NTN					
	100,000	25,000	0,83	7309BA	2	SNR					
	100,000	25,000	0,82	7309BBG	2	NTN					
	100,000	25,000	0,85	7309BG	2	NTN					
	100,000	25,000	0,83	7309BGA	2	SNR					
	100,000	25,000	0,93	7309BGM	2	SNR					
	100,000	25,000	0,80	CS309(6309SEE)	12	SNR					
	100,000	25,000	0,80	CS309LLU	12	NTN					
	100,000	25,000	1,02	QJ309MA	3	SNR					
	100,000	36,000	1,40	2309EEG15	6	SNR					
	100,000	36,000	1,21	2309G15	6	SNR					
	100,000	36,000	1,24	2309K	6	SNR					
	100,000	36,000	1,19	2309KG15	6	SNR					
	100,000	36,000	1,20	2309S	6	NTN					
	100,000	36,000	1,20	2309SK	6	NTN					
	100,000	36,000	1,24	4309A	4	SNR					
	100,000	39,000	1,43	51409	34	NTN-SNR					
	100,000	39,687	1,27	63309ZZ	1	NTN					
	100,000	39,700	1,34	3309A	5	SNR					
	100,000	39,700	1,33	5309EEG15	5	SNR					
	100,000	39,700	1,34	5309NRZG15	5-NR	SNR					
	100,000	39,700	1,40	5309S	5	NTN					
	100,000	39,700	1,33	5309ZZG15	5	SNR					
	100,000	39,700	1,26	63309LLB	1	NTN					
	100,000	39,700	1,28	63309LLU	1	NTN					
	100,000	39,700	1,503	DF0961CS15+TKZ0552	5	NTN					
	100,000	50,000	1,63	6309D2	1	NTN					
	100,000	50,000	1,65	6309ZZD2	1	NTN					
	100,000	50,000	1,69	7309BDB	2	NTN					
	100,000	50,000	1,69	7309BDF	2	NTN					
	100,000	50,000	1,69	7309BDT	2	NTN					
	100,000	50,000	1,66	7309DB	2	NTN					
	100,000	50,000	1,66	7309DF	2	NTN					
	100,000	50,000	1,67	7309DT	2	NTN					
100,000	37/29	1,38	UK309D1	9	NTN						
100,000	57/29	1,28	UC309D1	7	NTN						
100,000	57/29	1,33	UCS309D1	13	NTN						
100,000	57/30	1,28	UC309G2	7	SNR						
100,000	58,7/42,9	1,45	EX309G2	8	SNR						
100,000	58,7/42,9	1,45	UEL309D1	8	NTN						
100,000	58,7/42,9	1,50	UELS309D1N	14	NTN						
101,350	28,500	0,98	SX09A52LLU	2	NTN						
110,000	40,000	1,54	SX09A09LLU	2	NTN						
110,000	40/32	1,74	UK310G2H	9	SNR						
117,000	32,000	1,63	SX09B01LLU	2	NTN						
117,000	40,000	1,87	SX0965LLU	2	NTN						

								Brands		
d	D	B	Kg	Reference						
45,000	118,000	32,000	1,67	SX09A99LLU	2	NTN				
	118,000	40,000	1,92	SX0964LLU	2	NTN				
	120,000	29,000	1,53	6409	1	NTN-SNR				
	120,000	29,000	1,49	6409NR	1-NR	NTN				
	120,000	29,000	1,53	6409ZZ	1	NTN				
	120,000	29,000	1,73	7409	2	NTN				
	120,000	29,000	1,49	7409B	2	NTN				
	120,000	29,000	1,77	7409BG	2	NTN				
	120,000	58,000	3,57	7409BDB	2	NTN				
	135,000	36,000	2,25	SX09A41LLU	2	NTN				
	48,000	67,000	9,000	0,08	SC1037	1	NTN			
	50,000	65,000	7,000	0,05	6810	1	NTN			
65,000		7,000	0,05	6810LLB	1	NTN				
65,000		7,000	0,05	6810LLU	1	NTN				
65,000		7,000	0,05	6810ZZ	1	NTN				
70,000		14,000	0,15	51110	34	NTN-SNR				
72,000		12,000	0,13	6910	1	NTN				
72,000		12,000	0,14	6910LLB	1	NTN				
72,000		12,000	0,13	6910LLU	1	NTN				
72,000		12,000	0,13	6910Z	1	NTN				
72,000		12,000	0,13	6910ZZ	1	NTN				
72,000		12,000	0,13	6910ZZNR	1-NR	NTN				
72,000		12,000	0,13	7910	2	NTN				
72,000		24,000	0,29	7910DB	2	NTN				
78,000		22,000	0,37	51210	34	NTN-SNR				
78,000		28,000	0,379	DF1024LLBCS27/L417	5	NTN				
78,000		28,000	0,378	DF1024LLUACS35/L453	5	NTN				
80,000		10,000	0,18	16010	1	NTN-SNR				
80,000		16,000	0,27	6010	1	NTN-SNR				
80,000		16,000	0,26	6010E	1	SNR				
80,000		16,000	0,27	6010EE	1	SNR				
80,000		16,000	0,27	6010FT150	1	SNR				
80,000		16,000	0,27	6010FT150ZZ	1	SNR				
80,000		16,000	0,27	6010HVZZ	1	SNR				
80,000		16,000	0,25	6010LB	1	NTN				
80,000		16,000	0,26	6010LLB	1	NTN				
80,000		16,000	0,27	6010LLBNR	1-NR	NTN				
80,000		16,000	0,25	6010LLC	1	NTN				
80,000		16,000	0,25	6010LLH	1	NTN				
80,000		16,000	0,26	6010LLUNR	1-NR	NTN				
80,000		16,000	0,25	6010LU	1	NTN				
80,000		16,000	0,24	6010N	1-NR	NTN-SNR				
80,000		16,000	0,28	6010NEE	1-NR	SNR				
80,000		16,000	0,25	6010NR	1-NR	NTN-SNR				
80,000		16,000	0,28	6010NREE	1-NR	SNR				
80,000		16,000	0,27	6010NRZ	1-NR	SNR				
80,000		16,000	0,29	6010NRZZ	1-NR	SNR				
80,000		16,000	0,25	6010Z	1	NTN-SNR				
80,000		16,000	0,26	6010ZNR	1-NR	NTN				
80,000		16,000	0,26	6010ZZ	1	NTN-SNR				
80,000		16,000	0,27	6010ZZNR	1-NR	NTN				
80,000		16,000	0,31	7010	2	NTN				
80,000		16,000	0,30	7010B	2	NTN				
80,000		32,000	0,60	7010DB	2	NTN				
80,000		32,000	0,58	7010DF	2	NTN				
80,400		23,200	0,43	50TAG12	34	NTN				
90,000		20,000	0,53	1210	6	SNR				
90,000		20,000	0,53	1210K	6	SNR				
90,000	20,000	0,53	1210S	6	NTN					
90,000	20,000	0,53	1210SK	6	NTN					

								Brands	
d	D	B	Kg	Reference					
50,000	90,000	20,000	0,44	6210	1	NTN-SNR			
	90,000	20,000	0,47	6210E	1	SNR			
	90,000	20,000	0,47	6210EE	1	SNR			
	90,000	20,000	0,46	6210F600	1	SNR			
	90,000	20,000	0,47	6210F604	1	SNR			
	90,000	20,000	0,45	6210F605	1	SNR			
	90,000	20,000	0,47	6210FT150	1	SNR			
	90,000	20,000	0,47	6210FT150ZZ	1	SNR			
	90,000	20,000	0,48	6210HT200	1	SNR			
	90,000	20,000	0,47	6210HT200ZZ	1	SNR			
	90,000	20,000	0,47	6210HVZZ	1	SNR			
	90,000	20,000	0,44	6210LB	1	NTN			
	90,000	20,000	0,44	6210LBLU	1	NTN			
	90,000	20,000	0,44	6210LLB	1	NTN			
	90,000	20,000	0,48	6210LLBNR	1-NR	NTN			
	90,000	20,000	0,46	6210LLU	1	NTN			
	90,000	20,000	0,45	6210LLUN	1-NR	NTN			
	90,000	20,000	0,47	6210LLUNR	1-NR	NTN			
	90,000	20,000	0,44	6210LU	1	NTN			
	90,000	20,000	0,46	6210LUNR	1-NR	NTN			
	90,000	20,000	0,45	6210N	1-NR	SNR			
	90,000	20,000	0,47	6210NR	1-NR	NTN-SNR			
	90,000	20,000	0,50	6210NREE	1-NR	SNR			
	90,000	20,000	0,49	6210NRZ	1-NR	SNR			
	90,000	20,000	0,45	6210NRZZ	1-NR	SNR			
	90,000	20,000	0,44	6210Z	1	NTN-SNR			
	90,000	20,000	0,46	6210ZNR	1-NR	NTN			
	90,000	20,000	0,42	6210ZZ	1	NTN-SNR			
	90,000	20,000	0,47	6210ZZNR	1-NR	NTN			
	90,000	20,000	0,52	7210	2	NTN-SNR			
	90,000	20,000	0,47	7210B	2	NTN			
	90,000	20,000	0,47	7210BG	2	NTN			
	90,000	20,000	0,44	7210BGA	2	SNR			
	90,000	20,000	0,52	7210BGM	2	SNR			
	90,000	20,000	0,47	CS210(6210SEE)	12	SNR			
	90,000	20,000	0,47	CS210LLU	12	NTN			
	90,000	20,000	0,58	QJ210	3	NTN			
	90,000	20,000	0,576	QJ210C3	3	NTN			
	90,000	20,000	0,47	SC1084LLU	1	NTN			
	90,000	20,000	0,47	SX1084LLU	2	NTN			
	90,000	23,000	0,61	2210	6	SNR			
	90,000	23,000	0,60	2210EEG15	6	SNR			
	90,000	23,000	0,58	2210K	6	SNR			
	90,000	23,000	0,59	2210KEEG15	6	SNR			
	90,000	23,000	0,56	2210S	6	NTN			
	90,000	23,000	0,56	2210SK	6	NTN			
	90,000	23,000	0,58	4210A	4	SNR			
90,000	23,000	0,53	62210EE	1	SNR				
90,000	30,000	0,56	88510	1	NTN				
90,000	30,162	0,68	63210LLB	1	NTN				
90,000	30,162	0,68	63210LLU	1	NTN				
90,000	30,162	0,68	63210ZZ	1	NTN				
90,000	30,200	0,69	3210A	5	SNR				
90,000	30,200	0,70	5210EEG15	5	SNR				
90,000	30,200	0,76	5210NRZZG15	5-NR	SNR				
90,000	30,200	0,67	5210S	5	NTN				
90,000	30,200	0,69	5210ZZG15	5	SNR				
90,000	40,000	0,93	7210BDB	2	NTN				
90,000	40,000	0,93	7210BDF	2	NTN				
90,000	40,000	0,93	7210BDT	2	NTN				
90,000	40,000	0,91	7210DB	2	NTN				
90,000	40,000	0,91	7210DF	2	NTN				



						Brands
d	D	B	Kg	Reference		
50,000	90,000	20/58	0,85	11210G15	6	SNR
	90,000	32/24	0,97	UK210D1	9	NTN
	90,000	43,5/20	0,66	CUS210	15	SNR
	90,000	43,5/20	0,76	US210G2	10	SNR
	90,000	43,7/30,2	0,74	AELS210N	16	NTN
	90,000	43,7/30,2	0,80	CES210	16	SNR
	90,000	43,7/30,2	0,80	ES210G2	11	SNR
	90,000	51,6/23	0,80	CUC210	13	SNR
	90,000	51,6/23	0,80	UC210G2	7	SNR
	90,000	51,6/24	0,80	UC210D1	7	NTN
	90,000	51,6/24	0,80	UCS210LD1N	13	NTN
	90,000	62,7/49,2	1,01	CEX210	14	SNR
	90,000	62,7/49,2	1,01	EX210G2	8	SNR
	90,000	62,7/49,2	0,98	UEL210D1	8	NTN
	90,000	62,7/49,2	0,98	UELS210LD1N	14	NTN
	95,000	31,000	0,92	51310	34	NTN
	100,000	50,000	0,96	SC10A07ZZ	1	NTN
	100,000	50,000	0,96	SX10A07ZZ	2	NTN
	100,000	33/25	1,19	UK211G2H	9	SNR
	100,000	55,6/25	1,35	UCX10	7	NTN
	110,000	27,000	1,23	1310G15	6	SNR
	110,000	27,000	1,22	1310KG15	6	SNR
	110,000	27,000	1,25	1310S	6	NTN
	110,000	27,000	1,25	1310SK	6	NTN
	110,000	27,000	1,05	6310	1	NTN-SNR
	110,000	27,000	1,07	6310C	1	NTN
	110,000	27,000	1,10	6310E	1	SNR
	110,000	27,000	1,12	6310EE	1	SNR
	110,000	27,000	1,11	6310FT150	1	SNR
	110,000	27,000	1,11	6310FT150ZZ	1	SNR
	110,000	27,000	1,12	6310HT200	1	SNR
	110,000	27,000	1,11	6310HT200ZZ	1	SNR
	110,000	27,000	1,05	6310LB	1	NTN
	110,000	27,000	1,08	6310LH	1	NTN
	110,000	27,000	1,08	6310LLB	1	NTN
	110,000	27,000	1,12	6310LLBNR	1-NR	NTN
	110,000	27,000	1,08	6310LLU	1	NTN
	110,000	27,000	1,08	6310LLUNR	1-NR	NTN
	110,000	27,000	1,05	6310LU	1	NTN
	110,000	27,000	1,04	6310N	1-NR	NTN-SNR
	110,000	27,000	1,08	6310NEE	1-NR	SNR
	110,000	27,000	1,08	6310NR	1-NR	NTN-SNR
	110,000	27,000	1,07	6310NREE	1-NR	SNR
	110,000	27,000	1,14	6310NRZ	1-NR	SNR
	110,000	27,000	1,07	6310NRZZ	1-NR	SNR
	110,000	27,000	1,05	6310Z	1	NTN-SNR
	110,000	27,000	1,07	6310ZNR	1-NR	NTN
	110,000	27,000	1,08	6310ZZ	1	NTN-SNR
	110,000	27,000	1,12	6310ZZNR	1-NR	NTN
	110,000	27,000	1,08	7310	2	NTN
110,000	27,000	1,11	7310B	2	NTN	
110,000	27,000	1,07	7310BA	2	SNR	
110,000	27,000	1,08	7310BBG	2	NTN	
110,000	27,000	1,09	7310BG	2	NTN	
110,000	27,000	1,08	7310BGA	2	SNR	
110,000	27,000	1,22	7310BGM	2	SNR	
110,000	27,000	1,06	CS310LLU	12	NTN	
110,000	27,000	1,38	QJ310MA	3	SNR	
110,000	40,000	1,89	2310EEG15	6	SNR	
110,000	40,000	1,62	2310G15	6	SNR	
110,000	40,000	1,68	2310K	6	SNR	
110,000	40,000	1,58	2310KG15	6	SNR	

						Brands
d	D	B	Kg	Reference		
50,000	110,000	40,000	1,58	2310S	6	NTN
	110,000	40,000	1,58	2310SK	6	NTN
	110,000	40,000	1,64	4310A	4	SNR
	110,000	43,000	1,88	51410	34	NTN
	110,000	43,000	1,88	51410A	34	NTN
	110,000	44,400	1,77	3310A	5	SNR
	110,000	44,400	1,80	5310EEG15	5	SNR
	110,000	44,400	1,80	5310NRZZG15	5-NR	SNR
	110,000	44,400	1,95	5310S	5	NTN
	110,000	44,400	1,93	5310ZZG15	5	SNR
	110,000	44,400	1,71	63310LLB	1	NTN
	110,000	44,400	1,71	63310LLU	1	NTN
	110,000	44,400	1,71	63310ZZ	1	NTN
	110,000	54,000	2,10	6310D2	1	NTN
	110,000	54,000	2,16	6310ZZD2	1	NTN
	110,000	54,000	2,16	7310BDB	2	NTN
	110,000	54,000	2,18	7310BDF	2	NTN
	110,000	54,000	1,05	7310BDT	2	NTN
	110,000	54,000	2,14	7310DB	2	NTN
	110,000	54,000	2,14	7310DF	2	NTN
	110,000	54,000	2,18	7310DT	2	NTN
	110,000	108,000	4,44	7310BDBTT	2	NTN
	110,000	41/32	1,68	UK310D1	9	NTN
	110,000	61/32	1,65	UC310	7	NTN-SNR
	110,000	61/32	1,72	UCS310D1	13	NTN
	110,000	66,6/49,2	1,86	EX310G2	8	SNR
	110,000	66,6/49,2	1,86	UEL310D1	8	NTN
	110,000	66,6/49,2	1,93	UELS310D1N	14	NTN
	120,000	43/34	2,20	UK311G2H	9	SNR
	127,000	40,000	2,23	SC1059LLU	1	NTN
	127,000	40,000	2,23	SX1059LLU	2	NTN
	129,000	34,000	2,12	SC10A28LLU	1	NTN
	129,000	34,000	2,12	SX10A28LLU	2	NTN
	130,000	31,000	1,88	6410	1	NTN-SNR
	130,000	31,000	1,86	6410NR	1-NR	NTN
	130,000	31,000	1,53	6410ZZ	1	NTN
	130,000	31,000	2,12	7410	2	NTN
	130,000	31,000	1,86	7410B	2	NTN
	130,000	31,000	1,86	7410BG	2	NTN
	130,000	34,000	2,17	SC10A27LLU	1	NTN
130,000	34,000	2,17	SX10A27LLU	2	NTN	
130,000	62,000	3,72	7410BDB	2	NTN	
50,800	63,500	6,350	0,04	KYA020	2	NTN
51,650	88,100	21,000	0,45	SF1018	2	NTN
52,400	94,000	20,000	0,49	52TMK804	34	NTN
55,000	72,000	9,000	0,08	6811	1	NTN
	72,000	9,000	0,08	6811LLB	1	NTN
	72,000	9,000	0,08	6811LLU	1	NTN
	72,000	9,000	0,08	6811LU	1	NTN
	72,000	9,000	0,08	6811ZZ	1	NTN
	78,000	16,000	0,23	51111	34	NTN-SNR
	80,000	13,000	0,18	6911	1	NTN
	80,000	13,000	0,18	6911LLB	1	NTN
	80,000	13,000	0,18	6911LLU	1	NTN
	80,000	13,000	0,19	6911NR	1-NR	NTN
	80,000	13,000	0,18	6911Z	1	NTN
	80,000	13,000	0,18	6911ZZ	1	NTN
	80,000	13,000	0,18	6911ZZNR	1-NR	NTN

d	D	B	Kg	Reference			Brands
55,000	80,000	13,000	0,21	7911	2	NTN	
	82,000	16,000	0,23	55TNK29	34	NTN	
	85,600	19,400	0,36	SF1135	2	NTN	
	88,000	19,600	0,37	55TMK804X	34	NTN	
	90,000	11,000	0,25	16011	1	NTN-SNR	
	90,000	18,000	0,39	6011	1	NTN-SNR	
	90,000	18,000	0,40	6011E	1	SNR	
	90,000	18,000	0,39	6011EE	1	SNR	
	90,000	18,000	0,38	6011HVZZ	1	SNR	
	90,000	18,000	0,38	6011LB	1	NTN	
	90,000	18,000	0,39	6011LLB	1	NTN	
	90,000	18,000	0,40	6011LLBNR	1-NR	NTN	
	90,000	18,000	0,39	6011LLU	1	NTN	
	90,000	18,000	0,40	6011LLUNR	1-NR	NTN	
	90,000	18,000	0,38	6011LU	1	NTN	
	90,000	18,000	0,39	6011N	1-NR	NTN	
	90,000	18,000	0,39	6011NR	1-NR	NTN	
	90,000	18,000	0,41	6011NREE	1-NR	SNR	
	90,000	18,000	0,38	6011Z	1	NTN-SNR	
	90,000	18,000	0,39	6011ZNR	1-NR	NTN	
	90,000	18,000	0,39	6011ZZ	1	NTN-SNR	
	90,000	18,000	0,40	6011ZZNR	1-NR	NTN	
	90,000	18,000	0,37	7011	2	NTN	
	90,000	25,000	0,59	51211	34	NTN-SNR	
	90,000	36,000	0,78	6011D2	1	NTN	
	90,000	36,000	0,75	7011DB	2	NTN	
	90,000	36,000	0,75	7011DF	2	NTN	
	90,000	40,000	0,762	EC-DF1160LUALACS40PX1/L325	5	NTN	
	92,000	25,500	0,51	55TRK30A	34	NTN	
	100,000	21,000	0,71	1211	6	SNR	
	100,000	21,000	0,70	1211G15	6	SNR	
	100,000	21,000	0,69	1211K	6	SNR	
	100,000	21,000	0,71	1211S	6	NTN	
	100,000	21,000	0,71	1211SK	6	NTN	
	100,000	21,000	0,60	6211	1	NTN-SNR	
	100,000	21,000	0,62	6211E	1	SNR	
	100,000	21,000	0,63	6211EE	1	SNR	
	100,000	21,000	0,58	6211F600	1	SNR	
	100,000	21,000	0,61	6211F604	1	SNR	
	100,000	21,000	0,61	6211K	1	SNR	
	100,000	21,000	0,61	6211KEE	1	SNR	
	100,000	21,000	0,59	6211LB	1	NTN	
	100,000	21,000	0,58	6211LLB	1	NTN	
	100,000	21,000	0,63	6211LLBNR	1-NR	NTN	
	100,000	21,000	0,61	6211LLU	1	NTN	
	100,000	21,000	0,63	6211LLUNR	1-NR	NTN	
	100,000	21,000	0,59	6211LU	1	NTN	
	100,000	21,000	0,59	6211N	1-NR	NTN-SNR	
	100,000	21,000	0,62	6211NR	1-NR	NTN-SNR	
	100,000	21,000	0,64	6211NRZ	1-NR	SNR	
100,000	21,000	0,66	6211NRZZ	1-NR	SNR		
100,000	21,000	0,59	6211Z	1	NTN-SNR		
100,000	21,000	0,60	6211ZNR	1-NR	NTN		
100,000	21,000	0,61	6211ZZ	1	NTN-SNR		
100,000	21,000	0,62	6211ZZNR	1-NR	NTN		
100,000	21,000	0,60	7211	2	NTN		
100,000	21,000	0,62	7211B	2	NTN		
100,000	21,000	0,61	7211BA	2	SNR		
100,000	21,000	0,62	7211BG	2	NTN		
100,000	21,000	0,62	7211BGA	2	SNR		
100,000	21,000	0,69	7211BGM	2	SNR		
100,000	21,000	0,74	QJ211	3	NTN		

d	D	B	Kg	Reference			Brands
55,000	100,000	21,000	0,770	QJ211T1	3	NTN	
	100,000	25,000	0,79	2211	6	SNR	
	100,000	25,000	0,77	2211K	6	SNR	
	100,000	25,000	0,79	2211KEEG15	6	SNR	
	100,000	25,000	0,75	2211S	6	NTN	
	100,000	25,000	0,75	2211SK	6	NTN	
	100,000	25,000	0,82	4211A	4	SNR	
	100,000	33,300	0,97	3211A	5	SNR	
	100,000	33,300	0,95	5211EEG15	5	SNR	
	100,000	33,300	0,98	5211NRZZG15	5-NR	SNR	
	100,000	33,300	0,96	5211S	5	NTN	
	100,000	33,300	0,88	5211ZZG15	5	SNR	
	100,000	33,300	0,94	63211LLB	1	NTN	
	100,000	42,000	1,21	6211D2	1	NTN	
	100,000	42,000	1,23	7211BDB	2	NTN	
	100,000	42,000	1,23	7211BDF	2	NTN	
	100,000	42,000	1,21	7211DB	2	NTN	
	100,000	42,000	1,21	7211DF	2	NTN	
	100,000	21/60	1,13	11211G15	6	SNR	
	100,000	35/25	1,26	UK211D1	9	NTN	
	100,000	45,3/23	1,07	US211G2	10	SNR	
	100,000	48,4/32,5	0,87	ES211G2	11	SNR	
	100,000	55,6/25	1,08	UC211	7	NTN-SNR	
	100,000	55,6/25	1,08	UCS211LD1N	13	NTN	
	100,000	71,3/55,4	1,39	EX211G2	8	SNR	
	100,000	71,4/55,5	1,32	UEL211D1	8	NTN	
	100,000	71,4/55,5	1,32	UELS211LD1N	14	NTN	
	105,000	35,000	1,28	51311	34	NTN-SNR	
	110,000	36/27	1,51	UK212G2H	9	SNR	
	110,000	65,1/27	1,90	UCX11	7	NTN	
	120,000	29,000	1,64	1311G15	6	SNR	
	120,000	29,000	1,54	1311KG15	6	SNR	
	120,000	29,000	1,60	1311S	6	NTN	
	120,000	29,000	1,60	1311SK	6	NTN	
	120,000	29,000	1,37	6311	1	NTN-SNR	
	120,000	29,000	1,40	6311E	1	SNR	
	120,000	29,000	1,40	6311EE	1	SNR	
	120,000	29,000	1,37	6311F600	1	SNR	
	120,000	29,000	1,30	6311LB	1	NTN	
	120,000	29,000	1,31	6311LLB	1	NTN	
	120,000	29,000	1,40	6311LLBNR	1-NR	NTN	
	120,000	29,000	1,19	6311LLU	1	NTN	
	120,000	29,000	1,44	6311LLUNR	1-NR	NTN	
	120,000	29,000	1,30	6311LU	1	NTN	
	120,000	29,000	3,92	6311LUNR	1-NR	NTN	
	120,000	29,000	1,31	6311N	1-NR	NTN-SNR	
	120,000	29,000	1,37	6311NR	1-NR	NTN-SNR	
	120,000	29,000	1,34	6311Z	1	NTN	
	120,000	29,000	1,38	6311ZNR	1-NR	NTN	
	120,000	29,000	1,34	6311ZZ	1	NTN-SNR	
120,000	29,000	1,40	6311ZZNR	1-NR	NTN		
120,000	29,000	1,39	7311	2	NTN		
120,000	29,000	1,40	7311B	2	NTN		
120,000	29,000	1,41	7311BA	2	SNR		
120,000	29,000	1,41	7311BG	2	NTN		
120,000	29,000	1,41	7311BGA	2	SNR		
120,000	29,000	1,56	7311BGM	2	SNR		
120,000	29,000	3,916	QJ311	3	NTN		
120,000	29,000	1,68	QJ311MA	3	SNR		
120,000	29,000	1,63	SF1150	2	NTN		
120,000	43,000	2,07	2311G15	6	SNR		
120,000	43,000	2,12	2311K	6	SNR		

										Brands		
d	D	B	Kg	Reference								
55,000	120,000	43,000	2,01	2311KG15	6	SNR						
	120,000	43,000	2,03	2311S	6	NTN						
	120,000	43,000	2,03	2311SK	6	NTN						
	120,000	43,000	2,08	4311A	4	SNR						
	120,000	48,000	2,55	51411	34	NTN						
	120,000	49,200	2,53	3311A	5	SNR						
	120,000	49,200	2,66	3311B	5	SNR						
	120,000	49,200	2,35	5311NRZG15	5-NR	SNR						
	120,000	49,200	2,30	5311S	5	NTN						
	120,000	49,200	2,31	5311ZG15	5	SNR						
	120,000	49,200	2,21	63311LLB	1	NTN						
	120,000	49,200	2,21	63311LLU	1	NTN						
	120,000	49,200	2,20	63311ZZ	1	NTN						
	120,000	58,000	2,69	6311ZZD2	1	NTN						
	120,000	58,000	2,82	7311BDB	2	NTN						
	120,000	58,000	2,82	7311BDF	2	NTN						
	120,000	58,000	2,82	7311BDT	2	NTN						
	120,000	58,000	2,81	7311DB	2	NTN						
	120,000	58,000	2,81	7311DF	2	NTN						
	120,000	116,000	5,68	7311BDBTT	2	NTN						
	120,000	44/34	2,06	UK311D1	9	NTN						
	120,000	66/34	2,07	UC311	7	NTN-SNR						
	120,000	66/34	2,15	UCS311D1	13	NTN						
	120,000	73/55,6	2,30	EX311G2	8	SNR						
	120,000	73/55,6	2,34	UEL311D1	8	NTN						
	120,000	73/55,6	2,42	UELS311D1N	14	NTN						
	130,000	29,000	1,76	SC1165C3	1	NTN						
	130,000	29,000	1,79	SC1170LLB	1	NTN						
	130,000	29,000	1,76	SX1165	2	NTN						
	130,000	29,000	1,79	SX1170LLB	2	NTN						
	130,000	47/36	2,54	UK312G2H	9	SNR						
	140,000	33,000	2,34	6411	1	NTN-SNR						
	140,000	33,000	2,30	6411N	1-NR	SNR						
	140,000	33,000	2,28	6411NR	1-NR	NTN-SNR						
	140,000	33,000	2,35	6411ZZ	1	NTN						
	140,000	33,000	2,62	7411	2	NTN						
	140,000	33,000	2,69	7411B	2	NTN						
	140,000	33,000	2,69	7411BG	2	NTN						
	140,000	66,000	5,38	7411BDB	2	NTN						
	150,000	45,000	3,84	SC1159LLU	1	NTN						
	150,000	45,000	3,84	SX1159LLU	2	NTN						
	57,150	90,488	15,880	0,33	SC1108LU	1	NTN					
	60,000	78,000	10,000	0,11	6812	1	NTN					
		78,000	10,000	0,10	6812LLB	1	NTN					
		78,000	10,000	0,10	6812LLH	1	NTN					
		78,000	10,000	0,10	6812LLU	1	NTN					
		78,000	10,000	0,10	6812LU	1	NTN					
		78,000	10,000	0,10	6812ZZ	1	NTN					
		85,000	13,000	0,19	6912	1	NTN					
		85,000	13,000	0,19	6912LLB	1	NTN					
		85,000	13,000	0,19	6912LLU	1	NTN					
		85,000	13,000	0,19	6912LU	1	NTN					
		85,000	13,000	0,19	6912Z	1	NTN					
		85,000	13,000	0,19	6912ZZ	1	NTN					
		85,000	13,000	0,19	6912ZZNR	1-NR	NTN					
85,000		13,000	0,23	7912	2	NTN						
85,000		17,000	0,27	51112	34	NTN-SNR						
95,000		11,000	0,28	16012	1	NTN-SNR						
95,000		18,000	0,42	6012	1	NTN-SNR						
95,000		18,000	0,43	6012E	1	SNR						

										Brands	
d	D	B	Kg	Reference							
60,000	95,000	18,000	0,42	6012EE	1	SNR					
	95,000	18,000	0,40	6012LB	1	NTN					
	95,000	18,000	0,41	6012LLB	1	NTN					
	95,000	18,000	0,43	6012LLBNR	1-NR	NTN					
	95,000	18,000	0,41	6012LLU	1	NTN					
	95,000	18,000	0,43	6012LLUNR	1-NR	NTN					
	95,000	18,000	0,40	6012LU	1	NTN					
	95,000	18,000	0,41	6012LUZ	1	NTN					
	95,000	18,000	0,40	6012N	1-NR	NTN					
	95,000	18,000	0,40	6012NR	1-NR	NTN					
	95,000	18,000	0,40	6012Z	1	NTN-SNR					
	95,000	18,000	0,42	6012ZNR	1-NR	NTN					
	95,000	18,000	0,41	6012ZZ	1	NTN-SNR					
	95,000	18,000	0,43	6012ZZNR	1-NR	NTN					
	95,000	18,000	0,48	7012	2	NTN					
	95,000	19,000	0,39	SC12A04LLBA	1	NTN					
	95,000	19,000	0,39	SX12A04LLB	2	NTN					
	95,000	19,000	0,39	SX12A04LLBA	2	NTN					
	95,000	26,000	0,67	51212	34	NTN					
	95,000	36,000	0,83	6012D2	1	NTN					
	95,000	36,000	0,94	7012DB	2	NTN					
	95,000	36,000	0,90	7012DF	2	NTN					
	110,000	22,000	0,89	1212G15	6	SNR					
	110,000	22,000	0,89	1212KG15	6	SNR					
	110,000	22,000	0,90	1212S	6	NTN					
	110,000	22,000	0,90	1212SK	6	NTN					
	110,000	22,000	0,74	6212	1	NTN-SNR					
	110,000	22,000	0,78	6212E	1	SNR					
	110,000	22,000	0,79	6212EE	1	SNR					
	110,000	22,000	0,76	6212F600	1	SNR					
	110,000	22,000	0,75	6212LB	1	NTN					
	110,000	22,000	0,78	6212LLB	1	NTN					
	110,000	22,000	0,80	6212LLBNR	1-NR	NTN					
	110,000	22,000	0,78	6212LLU	1	NTN					
	110,000	22,000	0,79	6212LLUNR	1-NR	NTN					
	110,000	22,000	0,76	6212LU	1	NTN					
	110,000	22,000	0,78	6212N	1-NR	NTN-SNR					
	110,000	22,000	0,78	6212NR	1-NR	NTN-SNR					
	110,000	22,000	0,79	6212NRZ	1-NR	SNR					
	110,000	22,000	0,75	6212Z	1	NTN-SNR					
	110,000	22,000	0,78	6212ZNR	1-NR	NTN					
	110,000	22,000	0,77	6212ZZ	1	NTN-SNR					
	110,000	22,000	0,79	6212ZZNR	1-NR	NTN					
	110,000	22,000	0,78	7212	2	NTN					
	110,000	22,000	0,80	7212B	2	NTN					
	110,000	22,000	0,81	7212BA	2	SNR					
	110,000	22,000	0,80	7212BG	2	NTN					
	110,000	22,000	0,78	7212BGA	2	SNR					
	110,000	22,000	0,23	7212BGM	2	SNR					
	110,000	22,000	0,78	CS212(6212SEE)	12	SNR					
	110,000	22,000	0,78	CS212LLU	12	NTN					
	110,000	22,000	0,97	QJ212	3	NTN					
	110,000	22,000	0,971	QJ212C3	3	NTN					
	110,000	28,000	1,08	2212	6	SNR					
	110,000	28,000	1,16	2212EEG15	6	SNR					
110,000	28,000	1,08	2212K	6	SNR						
110,000	28,000	1,03	2212S	6	NTN						
110,000	28,000	1,03	2212SK	6	NTN						
110,000	28,000	1,10	4212A	4	SNR						
110,000	36,500	1,36	3212A	5	SNR						
110,000	36,500	1,28	5212EEG15	5	SNR						

								Brands	
d	D	B	Kg	Reference					
60,000	110,000	36,500	1,35	5212S	5	NTN			
	110,000	36,500	1,18	5212ZZG15	5	SNR			
	110,000	44,000	1,53	6212D2	1	NTN			
	110,000	44,000	1,59	7212BDB	2	NTN			
	110,000	44,000	1,59	7212BDF	2	NTN			
	110,000	44,000	1,56	7212DB	2	NTN			
	110,000	44,000	1,56	7212DF	2	NTN			
	110,000	22/62	1,51	11212G15	6	SNR			
	110,000	38/27	1,59	UK212D1	9	NTN			
	110,000	49,3/33,4	1,20	ES212G2	11	SNR			
	110,000	53,7/24	1,30	US212G2	10	SNR			
	110,000	65,1/27	1,53	UC212	7	NTN-SNR			
	110,000	65,1/27	1,59	UCS212LD1N	13	NTN			
	110,000	77,7/61,8	1,87	EX212G2	8	SNR			
	110,000	77,8/61,9	1,87	UEL212D1	8	NTN			
	110,000	77,8/61,9	1,93	UELS212LD1N	14	NTN			
	115,000	28,000	1,26	SC1279LLU	1	NTN			
	115,000	28,000	1,26	SX1279LLU	2	NTN			
	115,500	28,000	1,28	SC1278LLU	1	NTN			
	115,500	28,000	1,28	SX1278LLU	2	NTN			
	116,000	28,000	1,30	SC1282LLU	1	NTN			
	116,000	28,000	1,30	SX1282LLU	2	NTN			
	120,000	36/28	1,92	UK213G2H	9	SNR			
	120,000	65,1/32	2,27	UCX12	7	NTN			
	130,000	31,000	2,01	1312	6	SNR			
	130,000	31,000	1,99	1312K	6	SNR			
	130,000	31,000	2,03	1312S	6	NTN			
	130,000	31,000	2,03	1312SK	6	NTN			
	130,000	31,000	1,67	6312	1	NTN-SNR			
	130,000	31,000	1,74	6312EE	1	SNR			
	130,000	31,000	1,68	6312LB	1	NTN			
	130,000	31,000	1,72	6312LBLU	1	NTN			
	130,000	31,000	1,65	6312LLB	1	NTN			
	130,000	31,000	1,75	6312LLBNR	1-NR	NTN			
	130,000	31,000	1,71	6312LLU	1	NTN			
	130,000	31,000	1,77	6312LLUNR	1-NR	NTN			
	130,000	31,000	1,68	6312LU	1	NTN			
	130,000	31,000	1,73	6312LUNR	1-NR	NTN			
	130,000	31,000	1,63	6312N	1-NR	SNR			
	130,000	31,000	1,72	6312NR	1-NR	NTN			
	130,000	31,000	1,68	6312Z	1	NTN-SNR			
	130,000	31,000	1,72	6312ZNR	1-NR	NTN			
	130,000	31,000	1,60	6312ZZ	1	NTN-SNR			
	130,000	31,000	2,14	6312ZZNR	1-NR	NTN			
	130,000	31,000	1,72	7312	2	NTN			
	130,000	31,000	1,76	7312B	2	NTN			
	130,000	31,000	1,74	7312BA	2	SNR			
	130,000	31,000	1,72	7312BBG	2	NTN			
	130,000	31,000	1,76	7312BG	2	NTN			
	130,000	31,000	1,75	7312BGA	2	SNR			
130,000	31,000	1,91	7312BGM	2	SNR				
130,000	31,000	2,15	QJ312MA	3	SNR				
130,000	31,000	1,717	QJ312NR	3	NTN				
130,000	31,000	2,10	SE1211	2	NTN				
130,000	31,000	2,10	SE12118	2	NTN				
130,000	33,000	1,81	SC1221ZZ	1	NTN				
130,000	46,000	2,60	2312	6	SNR				
130,000	46,000	2,64	2312G15	6	SNR				
130,000	46,000	2,63	2312K	6	SNR				
130,000	46,000	2,52	2312KG15	6	SNR				
130,000	46,000	2,57	2312S	6	NTN				
130,000	46,000	2,57	2312SK	6	NTN				

								Brands	
d	D	B	Kg	Reference					
60,000	130,000	46,000	2,56	4312A	4	SNR			
	130,000	51,000	3,17	51412	34	NTN			
	130,000	53,975	2,85	63312LLB	1	NTN			
	130,000	53,975	2,86	63312LLU	1	NTN			
	130,000	53,975	2,85	63312ZZ	1	NTN			
	130,000	54,000	3,37	3312A	5	SNR			
	130,000	54,000	2,93	5312NRZZG15	5-NR	SNR			
	130,000	54,000	3,15	5312S	5	NTN			
	130,000	54,000	2,70	5312ZZG15	5	SNR			
	130,000	62,000	3,34	6312D2	1	NTN			
	130,000	62,000	3,42	6312ZZD2	1	NTN			
	130,000	62,000	3,43	7312BDB	2	NTN			
	130,000	62,000	3,52	7312BDF	2	NTN			
	130,000	62,000	3,52	7312BDT	2	NTN			
	130,000	62,000	3,43	7312DB	2	NTN			
	130,000	62,000	3,44	7312DF	2	NTN			
	130,000	47/36	2,53	UK312D1	9	NTN			
	130,000	71/36	2,60	UC312	7	NTN-SNR			
	130,000	71/36	2,70	UCS312D1	13	NTN			
	130,000	79,4/61,9	2,89	EX312G2	8	SNR			
	130,000	79,4/61,9	2,94	UEL312D1	8	NTN			
	130,000	79,4/61,9	3,04	UELS312D1N	14	NTN			
	140,000	33,000	2,22	6313/60	1	NTN			
	140,000	49/38	3,27	UK313G2H	9	SNR			
	150,000	35,000	2,77	6412	1	NTN-SNR			
	150,000	35,000	2,75	6412NR	1-NR	NTN			
	150,000	35,000	2,84	6412ZZ	1	NTN			
	150,000	35,000	2,75	7412	2	NTN			
	150,000	35,000	2,75	7412B	2	NTN			
	150,000	35,000	3,27	7412BG	2	NTN			
	150,000	36,000	3,06	SC1291LLU	1	NTN			
	150,000	36,000	3,06	SX1291LLU	2	NTN			
	152,000	36,000	3,20	SC1298LLU	1	NTN			
	152,000	36,000	3,20	SX1298LLU	2	NTN			
	63,500	76,200	6,350	0,05	KYA025	2	NTN		
79,375		15,876	0,17	KYB025DB	2	NTN			
98,400		17,460	0,50	SC1306	1	NTN			
98,407		17,462	0,43	SC1324	1	NTN			
65,000	85,000	10,000	0,13	6813	1	NTN			
	85,000	10,000	0,12	6813LLB	1	NTN			
	85,000	10,000	0,12	6813LLU	1	NTN			
	85,000	10,000	0,12	6813ZZ	1	NTN			
	90,000	13,000	0,19	6913	1	NTN			
	90,000	13,000	0,21	6913LLB	1	NTN			
	90,000	13,000	0,21	6913LLU	1	NTN			
	90,000	13,000	0,19	6913Z	1	NTN			
	90,000	13,000	0,20	6913ZZ	1	NTN			
	90,000	13,000	0,21	6913ZZNR	1-NR	NTN			
	90,000	13,000	0,25	7913	2	NTN			
	90,000	18,000	0,31	51113	34	NTN			
	100,000	11,000	0,29	16013	1	NTN-SNR			
	100,000	18,000	0,42	6013	1	NTN-SNR			
	100,000	18,000	0,45	6013E	1	SNR			
	100,000	18,000	0,44	6013EE	1	SNR			
	100,000	18,000	0,45	6013FT150	1	SNR			
	100,000	18,000	0,43	6013LB	1	NTN			
	100,000	18,000	0,44	6013LLB	1	NTN			
	100,000	18,000	0,46	6013LLBNR	1-NR	NTN			
100,000	18,000	0,44	6013LLHA	1	NTN				
100,000	18,000	0,44	6013LLU	1	NTN				



										Brands	
d	D	B	Kg	Reference							
65,000	100,000	18,000	0,43	6013LU	1	NTN					
	100,000	18,000	0,46	6013NR	1-NR	NTN-SNR					
	100,000	18,000	0,44	6013NRZ	1-NR	SNR					
	100,000	18,000	0,43	6013Z	1	NTN-SNR					
	100,000	18,000	0,44	6013ZNR	1-NR	NTN					
	100,000	18,000	0,44	6013ZZ	1	NTN-SNR					
	100,000	18,000	0,46	6013ZZNR	1-NR	NTN					
	100,000	18,000	0,43	7013	2	NTN					
	100,000	27,000	0,74	51213	34	NTN-SNR					
	100,000	36,000	0,88	6013D2	1	NTN					
	100,000	36,000	0,97	7013DB	2	NTN					
	100,000	36,000	0,88	7013DF	2	NTN					
	100,000	40,500	0,864	T53-EC-DF1301LUALACS43PX1/L325	5	NTN					
	120,000	23,000	1,13	1213	6	SNR					
	120,000	23,000	1,12	1213K	6	SNR					
	120,000	23,000	1,15	1213S	6	NTN					
	120,000	23,000	1,15	1213SK	6	NTN					
	120,000	23,000	0,99	6213	1	NTN-SNR					
	120,000	23,000	0,99	6213E	1	SNR					
	120,000	23,000	1,02	6213EE	1	SNR					
	120,000	23,000	0,97	6213F600	1	SNR					
	120,000	23,000	1,00	6213FT150	1	SNR					
	120,000	23,000	0,99	6213LB	1	NTN					
	120,000	23,000	0,98	6213LLB	1	NTN					
	120,000	23,000	0,98	6213LLBNR	1-NR	NTN					
	120,000	23,000	0,98	6213LLU	1	NTN					
	120,000	23,000	1,02	6213LLUNR	1-NR	NTN					
	120,000	23,000	0,99	6213LU	1	NTN					
	120,000	23,000	0,97	6213N	1-NR	NTN-SNR					
	120,000	23,000	0,97	6213NR	1-NR	NTN-SNR					
	120,000	23,000	0,97	6213Z	1	NTN-SNR					
	120,000	23,000	1,01	6213ZNR	1-NR	NTN					
	120,000	23,000	0,98	6213ZZ	1	NTN-SNR					
	120,000	23,000	1,02	6213ZZNR	1-NR	NTN					
	120,000	23,000	0,96	7213	2	NTN					
	120,000	23,000	0,97	7213B	2	NTN					
	120,000	23,000	1,03	7213BA	2	SNR					
	120,000	23,000	1,03	7213BG	2	NTN					
	120,000	23,000	1,03	7213BGA	2	SNR					
	120,000	23,000	1,14	7213BGM	2	SNR					
	120,000	23,000	0,97	CS213LLU	12	NTN					
	120,000	23,000	1,24	QJ213	3	NTN					
	120,000	31,000	1,49	2213	6	SNR					
	120,000	31,000	1,45	2213K	6	SNR					
	120,000	31,000	1,40	2213S	6	NTN					
	120,000	31,000	1,40	2213SK	6	NTN					
	120,000	31,000	1,45	4213A	4	SNR					
	120,000	38,100	1,65	3213A	5	SNR					
	120,000	38,100	1,64	5213EEG15	5	SNR					
	120,000	38,100	1,67	5213NRZZG15	5-NR	SNR					
	120,000	38,100	1,65	5213S	5	NTN					
	120,000	38,100	1,63	5213ZZG15	5	SNR					
	120,000	46,000	2,06	7213BDB	2	NTN					
	120,000	46,000	2,05	7213BDF	2	NTN					
	120,000	46,000	2,04	7213DB	2	NTN					
	120,000	46,000	2,04	7213DF	2	NTN					
	120,000	40/32	2,00	UK213D1	9	NTN					
	120,000	65,1/28	1,86	UC213G2	7	SNR					
120,000	65,1/32	1,85	UC213D1	7	NTN						
120,000	65,1/32	1,92	UCS213D1	13	NTN						
120,000	85,7/68,2	2,41	EX213G2	8	SNR						
120,000	85,7/68,3	2,48	UEL213D1	8	NTN						

										Brands	
d	D	B	Kg	Reference							
65,000	125,000	74,6/33	2,45	UCX13	7	NTN					
	130,000	41/30	2,72	UK215G2H	9	SNR					
	140,000	33,000	2,54	1313S	6	NTN					
	140,000	33,000	2,54	1313SK	6	NTN					
	140,000	33,000	2,08	6313	1	NTN-SNR					
	140,000	33,000	2,16	6313EE	1	SNR					
	140,000	33,000	2,09	6313BLU	1	NTN					
	140,000	33,000	2,03	6313LLB	1	NTN					
	140,000	33,000	2,13	6313LLBNR	1-NR	NTN					
	140,000	33,000	2,09	6313LLU	1	NTN					
	140,000	33,000	2,15	6313LLUNR	1-NR	NTN					
	140,000	33,000	2,06	6313LU	1	NTN					
	140,000	33,000	2,12	6313LUNR	1-NR	NTN					
	140,000	33,000	2,09	6313N	1-NR	SNR					
	140,000	33,000	2,13	6313NR	1-NR	NTN-SNR					
	140,000	33,000	2,07	6313Z	1	NTN-SNR					
	140,000	33,000	2,12	6313ZNR	1-NR	NTN					
	140,000	33,000	2,02	6313ZZ	1	NTN-SNR					
	140,000	33,000	2,14	6313ZZNR	1-NR	NTN					
	140,000	33,000	2,11	7313	2	NTN					
	140,000	33,000	2,15	7313B	2	NTN					
	140,000	33,000	2,13	7313BG	2	NTN					
	140,000	33,000	2,12	7313BGA	2	SNR					
	140,000	33,000	2,40	7313BGM	2	SNR					
	140,000	33,000	2,63	QJ313MA	3	SNR					
	140,000	33,000	2,60	SE1305	2	NTN					
	140,000	35,000	2,23	SC1355ZZ	1	NTN					
	140,000	48,000	3,17	2313G15	6	SNR					
	140,000	48,000	3,15	2313K	6	SNR					
	140,000	48,000	3,07	2313K615	6	SNR					
	140,000	48,000	3,20	2313S	6	NTN					
	140,000	48,000	3,20	2313SK	6	NTN					
	140,000	48,000	3,22	4313A	4	SNR					
	140,000	56,000	4,03	51413	34	NTN					
	140,000	58,700	4,20	3313A	5	SNR					
	140,000	58,700	3,68	5313NRZZG15	5-NR	SNR					
	140,000	58,700	3,85	5313S	5	NTN					
	140,000	58,700	3,59	5313ZZG15	5	SNR					
	140,000	58,700	3,59	63313LLB	1	NTN					
	140,000	58,700	3,59	63313LLU	1	NTN					
	140,000	58,700	3,59	63313ZZ	1	NTN					
	140,000	66,000	4,09	6313D2	1	NTN					
	140,000	66,000	4,04	6313ZZD2	1	NTN					
	140,000	66,000	4,09	7313BDB	2	NTN					
	140,000	66,000	4,09	7313BDF	2	NTN					
	140,000	66,000	4,20	7313DB	2	NTN					
	140,000	66,000	4,20	7313DF	2	NTN					
	140,000	49/39	3,08	UK313D1	9	NTN					
	140,000	75/38	3,25	UC313G2	7	SNR					
	140,000	75/39	3,25	UC313D1	7	NTN					
	140,000	75/39	3,37	UCS313D1	13	NTN					
	140,000	85,7/65,1	3,66	EX313G2	8	SNR					
	140,000	85,7/65,1	3,67	UEL313D1	8	NTN					
	140,000	85,7/65,1	3,79	UELS313D1N	14	NTN					
	155,000	33,000	2,93	SC1352	1	NTN					
	155,000	33,000	2,93	SX1352	2	NTN					
	160,000	37,000	3,36	6413	1	NTN-SNR					
	160,000	37,000	3,29	6413NR	1-NR	NTN					
160,000	37,000	3,29	7413	2	NTN						
160,000	37,000	3,29	7413B	2	NTN						
160,000	37,000	3,29	7413BG	2	NTN						
160,000	37,000	3,29	QJ413	3	NTN						

								Brands	
d	D	B	Kg	Reference					
65,000	160,000	37,000	3,290	TS2-QJ413C4U35K	3	NTN			
	160,000	55/42	5,03	UK315G2H	9	SNR			
66,000	126,000	33,500	1,219	TM-DF1359CS32V4	5	NTN			
69,850	104,775	17,462	0,46	SC1407	1	NTN			
70,000	90,000	10,000	0,14	6814	1	NTN			
	90,000	10,000	0,13	6814LH	1	NTN			
	90,000	10,000	0,13	6814LLB	1	NTN			
	90,000	10,000	0,13	6814LLU	1	NTN			
	90,000	10,000	0,13	6814LU	1	NTN			
	90,000	10,000	0,13	6814ZZ	1	NTN			
	95,000	18,000	0,36	51114	34	NTN-SNR			
	95,000	40,000	0,670	DF1411LLCS32PX1V1	5	NTN			
	100,000	12,000	0,27	SC1467	1	NTN			
	100,000	16,000	0,33	6914	1	NTN			
	100,000	16,000	0,33	6914LLB	1	NTN			
	100,000	16,000	0,33	6914LLU	1	NTN			
	100,000	16,000	0,32	6914ZZ	1	NTN			
	100,000	16,000	0,40	7914	2	NTN			
	100,000	32,000	0,64	7914DB	2	NTN			
	105,000	13,000	0,36	SC1469	1	NTN			
	105,000	27,000	0,79	51214	34	NTN-SNR			
	110,000	13,000	0,44	16014	1	NTN-SNR			
	110,000	20,000	0,61	6014	1	NTN-SNR			
	110,000	20,000	0,63	6014EE	1	SNR			
	110,000	20,000	0,60	6014LB	1	NTN			
	110,000	20,000	0,62	6014LLB	1	NTN			
	110,000	20,000	0,61	6014LLU	1	NTN			
	110,000	20,000	0,59	6014LU	1	NTN			
	110,000	20,000	0,63	6014NR	1-NR	NTN-SNR			
	110,000	20,000	0,64	6014NREE	1-NR	SNR			
	110,000	20,000	0,60	6014Z	1	NTN-SNR			
	110,000	20,000	0,61	6014ZNR	1-NR	NTN			
	110,000	20,000	0,61	6014ZZ	1	NTN-SNR			
	110,000	20,000	0,63	6014ZZNR	1-NR	NTN			
	110,000	20,000	0,71	7014	2	NTN			
	110,000	36,000	0,80	SC1408LLU	1	NTN			
	110,000	36,000	0,80	SX1408LLU	2	NTN			
	110,000	36,000	1,083	TS2-DF1402	5	NTN			
	110,000	40,000	1,29	7014DB	2	NTN			
	117,000	27,000	0,93	SF1412	2	NTN			
	125,000	24,000	1,30	1214S	6	NTN			
	125,000	24,000	1,076	2TS2-QJ214AW-1C4PX2S20	3	NTN			
	125,000	24,000	1,05	6214	1	NTN-SNR			
	125,000	24,000	1,08	6214E	1	SNR			
	125,000	24,000	1,10	6214EE	1	SNR			
	125,000	24,000	1,08	6214F600	1	SNR			
	125,000	24,000	1,05	6214LB	1	NTN			
	125,000	24,000	1,06	6214LLB	1	NTN			
	125,000	24,000	1,10	6214LLBNR	1-NR	NTN			
	125,000	24,000	1,06	6214LLU	1	NTN			
	125,000	24,000	1,06	6214LU	1	NTN			
125,000	24,000	1,08	6214N	1-NR	SNR				
125,000	24,000	1,09	6214NR	1-NR	NTN				
125,000	24,000	1,05	6214Z	1	NTN-SNR				
125,000	24,000	1,08	6214ZNR	1-NR	NTN				
125,000	24,000	1,06	6214ZZ	1	NTN-SNR				
125,000	24,000	1,10	6214ZZNR	1-NR	NTN				
125,000	24,000	1,10	7214	2	NTN				
125,000	24,000	1,11	7214B	2	NTN				

								Brands	
d	D	B	Kg	Reference					
70,000	125,000	24,000	1,11	7214BA	2	SNR			
	125,000	24,000	1,11	7214BG	2	NTN			
	125,000	24,000	1,11	7214BGA	2	SNR			
	125,000	24,000	1,23	7214BGM	2	SNR			
	125,000	24,000	1,360	QJ214CS136	3	NTN			
	125,000	24,000	1,07	SF1452	2	NTN			
	125,000	31,000	1,58	2214	6	SNR			
	125,000	31,000	1,52	2214S	6	NTN			
	125,000	31,000	1,51	4214A	4	SNR			
	125,000	39,700	1,89	3214A	5	SNR			
	125,000	39,700	1,81	5214EEG15	5	SNR			
	125,000	39,700	1,84	5214NRZG15	5-NR	SNR			
	125,000	39,700	1,80	5214S	5	NTN			
	125,000	39,700	1,80	5214ZZG15	5	SNR			
	125,000	39,700	1,77	63214ZZ	1	NTN			
	125,000	40,000	1,99	51314	34	NTN			
	125,000	48,000	2,22	7214BDB	2	NTN			
	125,000	48,000	2,20	7214DB	2	NTN			
	125,000	48,000	2,20	7214DF	2	NTN			
	125,000	96,000	4,36	7214DTBT	2	NTN			
	125,000	74,6/30	2,05	UC214G2	7	SNR			
	125,000	74,6/33	2,10	UC214D1	7	NTN			
	125,000	74,6/33	2,17	UCS214D1	13	NTN			
	125,000	85,7/68,2	2,57	EX214G2	8	SNR			
	125,000	85,7/68,3	2,47	UEL214D1	8	NTN			
	130,000	77,8/34	2,47	UCX14	7	NTN			
	140,000	44/33	3,24	UK216G2H	9	SNR			
	150,000	35,000	3,19	1314S	6	NTN			
	150,000	35,000	2,55	6314	1	NTN-SNR			
	150,000	35,000	2,60	6314EE	1	SNR			
	150,000	35,000	2,54	6314LB	1	NTN			
	150,000	35,000	2,46	6314LBLU	1	NTN			
	150,000	35,000	2,48	6314LLB	1	NTN			
	150,000	35,000	2,49	6314LLU	1	NTN			
	150,000	35,000	2,54	6314LU	1	NTN			
	150,000	35,000	2,57	6314NR	1-NR	NTN			
	150,000	35,000	2,54	6314Z	1	NTN-SNR			
	150,000	35,000	2,59	6314ZNR	1-NR	NTN			
	150,000	35,000	2,48	6314ZZ	1	NTN-SNR			
	150,000	35,000	2,62	6314ZZNR	1-NR	NTN			
	150,000	35,000	2,90	7314	2	NTN			
	150,000	35,000	2,57	7314B	2	NTN			
	150,000	35,000	2,56	7314BG	2	NTN			
	150,000	35,000	2,63	7314BGA	2	SNR			
	150,000	35,000	2,92	7314BGM	2	SNR			
	150,000	35,000	3,17	QJ314	3	NTN			
	150,000	35,000	3,170	QJ314C4U35K	3	NTN			
150,000	35,000	3,20	QJ314MA	3	SNR				
150,000	35,000	2,56	QJ314NR	3	NTN				
150,000	35,000	2,560	QJ314NRCS138U35K	3	NTN				
150,000	35,000	2,49	SC1414	1	NTN				
150,000	35,000	2,58	SC1420	1	NTN				
150,000	35,000	2,57	SC1458	1	NTN				
150,000	35,000	2,569	TM-QJ314C4U35K	3	NTN				
150,000	51,000	3,97	2314	6	SNR				
150,000	51,000	3,90	2314S	6	NTN				
150,000	60,000	4,94	51414	34	NTN				
150,000	63,500	5,10	3314B	5	SNR				
150,000	63,500	4,90	5314S	5	NTN				
150,000	63,500	4,48	63314LLB	1	NTN				
150,000	63,500	4,45	63314ZZ	1	NTN				
150,000	70,000	4,37	6314D2	1	NTN				

d	D	B	Kg	Reference							Brands
70,000	150,000	70,000	5,01	6314ZZD2	1	NTN					
	150,000	70,000	4,37	7314BDB	2	NTN					
	150,000	70,000	4,37	7314BDF	2	NTN					
	150,000	70,000	4,37	7314BDT	2	NTN					
	150,000	70,000	5,16	7314DB	2	NTN					
	150,000	70,000	5,16	7314DF	2	NTN					
	150,000	140,000	10,24	7314DTBT	2	NTN					
	150,000	78/40	3,95	UC314G2	7	SNR					
	150,000	78/41	3,89	UC314D1	7	NTN					
	150,000	78/41	4,03	UCS314D1	13	NTN					
	150,000	92,1/68,3	4,50	EX314G2	8	SNR					
	150,000	92,1/68,3	4,40	UEL314D1	8	NTN					
	150,000	92,1/68,3	4,54	UELS314D1N	14	NTN					
	170,000	55/44	5,83	UK316G2H	9	SNR					
	180,000	42,000	4,83	6414	1	NTN-SNR					
	180,000	42,000	4,81	7414	2	NTN					
	180,000	42,000	4,81	7414B	2	NTN					
	180,000	42,000	5,70	7414BG	2	NTN					
	180,000	84,000	9,62	6414D2	1	NTN					
	180,000	84,000	9,62	7414DB	2	NTN					
72,000	130,000	25,000	1,30	6215/72	1	NTN					
75,000	95,000	10,000	0,14	6815	1	NTN					
	95,000	10,000	0,14	6815LLB	1	NTN					
	95,000	10,000	0,14	6815LLU	1	NTN					
	95,000	10,000	0,14	6815ZZ	1	NTN					
	100,000	19,000	0,40	51115	34	NTN-SNR					
	105,000	16,000	0,36	6915	1	NTN					
	105,000	16,000	0,35	6915LLB	1	NTN					
	105,000	16,000	0,34	6915LLU	1	NTN					
	105,000	16,000	0,36	6915LU	1	NTN					
	105,000	16,000	0,33	6915Z	1	NTN					
	105,000	16,000	0,34	6915ZZ	1	NTN					
	105,000	16,000	0,42	7915	2	NTN					
	110,000	27,000	0,83	51215	34	NTN-SNR					
	115,000	13,000	0,47	16015	1	NTN-SNR					
	115,000	20,000	0,65	6015	1	NTN-SNR					
	115,000	20,000	0,66	6015E	1	SNR					
	115,000	20,000	0,65	6015EE	1	SNR					
	115,000	20,000	0,63	6015LB	1	NTN					
	115,000	20,000	0,65	6015LLB	1	NTN					
	115,000	20,000	0,65	6015LLU	1	NTN					
	115,000	20,000	0,63	6015LU	1	NTN					
	115,000	20,000	0,67	6015NR	1-NR	NTN					
	115,000	20,000	0,63	6015Z	1	NTN-SNR					
	115,000	20,000	0,65	6015ZNR	1-NR	NTN					
	115,000	20,000	0,65	6015ZZ	1	NTN-SNR					
	115,000	20,000	0,66	6015ZZNR	1-NR	NTN					
	115,000	20,000	0,72	7015	2	NTN					
	115,000	40,000	1,44	7015DB	2	NTN					
	130,000	25,000	1,38	1215	6	SNR					
	130,000	25,000	1,37	1215K	6	SNR					
	130,000	25,000	1,41	1215S	6	NTN					
	130,000	25,000	1,41	1215SK	6	NTN					
	130,000	25,000	1,185	2TS2-QJ215DW-4C4P6S10	3	NTN					
	130,000	25,000	1,18	6215	1	NTN-SNR					
	130,000	25,000	1,19	6215EE	1	SNR					
	130,000	25,000	1,15	6215LB	1	NTN					
	130,000	25,000	1,15	6215LLB	1	NTN					
	130,000	25,000	1,15	6215LLU	1	NTN					
	130,000	25,000	1,20	6215LLUNR	1-NR	NTN					

d	D	B	Kg	Reference							Brands
75,000	130,000	25,000	1,15	6215LU	1	NTN					
	130,000	25,000	1,18	6215N	1-NR	NTN					
	130,000	25,000	1,22	6215NR	1-NR	NTN					
	130,000	25,000	1,15	6215Z	1	NTN					
	130,000	25,000	1,19	6215ZNR	1-NR	NTN					
	130,000	25,000	1,12	6215ZZ	1	NTN-SNR					
	130,000	25,000	1,20	6215ZZNR	1-NR	NTN					
	130,000	25,000	1,17	7215	2	NTN					
	130,000	25,000	1,19	7215B	2	NTN					
	130,000	25,000	1,19	7215BA	2	SNR					
	130,000	25,000	1,20	7215BG	2	NTN					
	130,000	25,000	1,19	7215BGA	2	SNR					
	130,000	25,000	1,34	7215BGM	2	SNR					
	130,000	25,000	1,47	QJ215	3	NTN					
	130,000	25,000	1,431	QJ215AL1BW-1C4P6S10	3	NTN					
	130,000	25,000	1,471	QJ215EX1C3U35K	3	NTN					
	130,000	25,000	1,38	SF1554	2	NTN					
	130,000	31,000	1,63	2215	6	SNR					
	130,000	31,000	1,61	2215K	6	SNR					
	130,000	31,000	1,60	2215S	6	NTN					
	130,000	31,000	1,60	2215SK	6	NTN					
	130,000	31,000	1,81	4215A	4	SNR					
	130,000	41,300	1,91	3215A	5	SNR					
	130,000	41,300	1,90	5215S	5	NTN					
	130,000	50,000	2,40	7215BDB	2	NTN					
	130,000	50,000	2,36	7215DB	2	NTN					
	130,000	50,000	2,36	7215DF	2	NTN					
	130,000	75,000	3,63	7215DBDT	2	NTN					
	130,000	44/34	2,56	UK215D1	9	NTN					
	130,000	77,8/30	2,21	UC215G2	7	SNR					
	130,000	77,8/34	2,35	UC215D1	7	NTN					
	130,000	77,8/34	2,43	UCS215D1	13	NTN					
	130,000	92/74,6	2,68	UEL215D1	8	NTN					
	130,000	92,1/74,6	2,84	EX215G2	8	SNR					
	135,000	44,000	2,57	51315	34	NTN					
	140,000	82,6/35	3,11	UCX15	7	NTN					
	150,000	44/35	3,87	UK217G2H	9	SNR					
	160,000	37,000	3,64	1315	6	SNR					
	160,000	37,000	3,58	1315K	6	SNR					
	160,000	37,000	3,65	1315S	6	NTN					
160,000	37,000	3,65	1315SK	6	NTN						
160,000	37,000	3,02	6315	1	NTN-SNR						
160,000	37,000	3,10	6315EE	1	SNR						
160,000	37,000	3,01	6315LB	1	NTN						
160,000	37,000	3,05	6315LLB	1	NTN						
160,000	37,000	3,05	6315LLU	1	NTN						
160,000	37,000	3,12	6315LLUNR	1-NR	NTN						
160,000	37,000	3,01	6315LU	1	NTN						
160,000	37,000	3,07	6315NR	1-NR	NTN						
160,000	37,000	3,00	6315Z	1	NTN						
160,000	37,000	3,06	6315ZNR	1-NR	NTN						
160,000	37,000	3,04	6315ZZ	1	NTN-SNR						
160,000	37,000	3,10	6315ZZNR	1-NR	NTN						
160,000	37,000	3,07	7315	2	NTN						
160,000	37,000	3,13	7315B	2	NTN						
160,000	37,000	3,08	7315BBG	2	NTN						
160,000	37,000	3,12	7315BG	2	NTN						
160,000	37,000	3,52	7315BGM	2	SNR						
160,000	37,000	3,081	QJ315	3	NTN						
160,000	37,000	3,97	QJ315N2MA	3							

d	D	B	Kg	Reference			Brands
75,000	160,000	55,000	4,78	2315K	6	SNR	
	160,000	55,000	4,77	2315S	6	NTN	
	160,000	55,000	4,77	2315SK	6	NTN	
	160,000	65,000	5,97	51415	34	NTN	
	160,000	68,262	5,44	63315LLB	1	NTN	
	160,000	74,000	6,24	7315BDB	2	NTN	
	160,000	74,000	4,83	7315BDF	2	NTN	
	160,000	74,000	6,20	7315DB	2	NTN	
	160,000	74,000	6,20	7315DF	2	NTN	
	160,000	100/74,6	5,34	EX315G2	8	SNR	
	160,000	100/74,6	5,34	UEL315D1	8	NTN	
	160,000	100/74,6	5,50	UELS315D1N	14	NTN	
	160,000	55/43	4,84	UK315D1	9	NTN	
	160,000	82/42	4,33	UC315G2	7	SNR	
	160,000	82/43	4,72	UC315D1	7	NTN	
	160,000	82/43	4,88	UCS315D1	13	NTN	
	180,000	60/46	6,89	UK317G2H	9	SNR	
	190,000	45,000	5,89	6415	1	NTN	
	190,000	45,000	5,71	7415BG	2	NTN	
	76,200	88,900	6,350	0,06	KYA030	2	NTN
80,000	100,000	10,000	0,15	6816	1	NTN	
	100,000	10,000	0,15	6816LLB	1	NTN	
	100,000	10,000	0,15	6816LLU	1	NTN	
	100,000	10,000	0,15	6816ZZ	1	NTN	
	105,000	19,000	0,40	51116	34	NTN-SNR	
	110,000	16,000	0,37	6916	1	NTN	
	110,000	16,000	0,36	6916LLB	1	NTN	
	110,000	16,000	0,37	6916LLU	1	NTN	
	110,000	16,000	0,36	6916ZZ	1	NTN	
	110,000	16,000	0,44	7916	2	NTN	
	110,000	32,000	0,89	7916DB	2	NTN	
	115,000	28,000	0,91	51216	34	NTN-SNR	
	125,000	14,000	0,60	16016	1	NTN-SNR	
	125,000	22,000	0,85	6016	1	NTN-SNR	
	125,000	22,000	0,86	6016EE	1	SNR	
	125,000	22,000	0,83	6016LB	1	NTN	
	125,000	22,000	0,86	6016LLB	1	NTN	
	125,000	22,000	0,86	6016LLU	1	NTN	
	125,000	22,000	0,83	6016LU	1	NTN	
	125,000	22,000	0,85	6016N	1-NR	NTN	
	125,000	22,000	0,89	6016NR	1-NR	NTN	
	125,000	22,000	0,83	6016Z	1	NTN	
	125,000	22,000	0,87	6016ZNR	1-NR	NTN	
	125,000	22,000	0,86	6016ZZ	1	NTN-SNR	
	125,000	22,000	0,89	6016ZZNR	1-NR	NTN	
	125,000	22,000	0,99	7016	2	NTN	
	125,000	44,000	1,86	7016DB	2	NTN	
	140,000	26,000	1,65	1216	6	SNR	
	140,000	26,000	1,63	1216K	6	SNR	
	140,000	26,000	1,73	1216S	6	NTN	
	140,000	26,000	1,73	1216SK	6	NTN	
	140,000	26,000	1,39	6216	1	NTN-SNR	
	140,000	26,000	1,41	6216E	1	SNR	
	140,000	26,000	1,44	6216EE	1	SNR	
	140,000	26,000	1,38	6216LB	1	NTN	
	140,000	26,000	1,39	6216LLB	1	NTN	
	140,000	26,000	1,39	6216LLU	1	NTN	
	140,000	26,000	1,35	6216LLUNR	1-NR	NTN	
	140,000	26,000	1,38	6216LU	1	NTN	
	140,000	26,000	1,45	6216NR	1-NR	NTN	

d	D	B	Kg	Reference			Brands
80,000	140,000	26,000	1,38	6216Z	1	NTN	
	140,000	26,000	1,42	6216ZNR	1-NR	NTN	
	140,000	26,000	1,39	6216ZZ	1	NTN-SNR	
	140,000	26,000	1,44	6216ZZNR	1-NR	NTN	
	140,000	26,000	1,45	7216	2	NTN	
	140,000	26,000	1,49	7216B	2	NTN	
	140,000	26,000	1,49	7216BG	2	NTN	
	140,000	26,000	1,66	7216BGM	2	SNR	
	140,000	26,000	1,61	SF1634	2	NTN	
	140,000	26,000	1,41	SF1656	2	NTN	
	140,000	26,000	1,830	TM-QJ216CS136U35K	3	NTN	
	140,000	33,000	2,07	2216	6	SNR	
	140,000	33,000	2,06	2216K	6	SNR	
	140,000	33,000	1,97	2216S	6	NTN	
	140,000	33,000	1,97	2216SK	6	NTN	
	140,000	33,000	2,28	4216A	4	SNR	
	140,000	44,000	2,71	51316	34	NTN	
	140,000	44,400	2,45	3216A	5	SNR	
	140,000	44,400	2,50	5216S	5	NTN	
	140,000	52,000	2,78	6216ZZD2	1	NTN	
	140,000	52,000	2,98	7216BDB	2	NTN	
	140,000	52,000	2,86	7216BDF	2	NTN	
	140,000	52,000	2,90	7216DB	2	NTN	
	140,000	52,000	2,90	7216DF	2	NTN	
	140,000	45/35	3,23	UK216D1	9	NTN	
	140,000	82,6/33	2,79	UC216G2	7	SNR	
	140,000	82,6/35	2,80	UC216D1	7	NTN	
	140,000	82,6/35	2,89	UCS216D1	13	NTN	
	140,000	95,2/74,6	3,12	EX216G2	8	SNR	
	150,000	85,7/36	3,79	UCX16	7	NTN	
	160,000	48/37	4,69	UK218G2H	9	SNR	
	170,000	39,000	4,31	1316S	6	NTN	
	170,000	39,000	4,31	1316SK	6	NTN	
	170,000	39,000	3,61	6316	1	NTN-SNR	
	170,000	39,000	3,65	6316EE	1	SNR	
	170,000	39,000	3,59	6316LB	1	NTN	
	170,000	39,000	3,66	6316LBU	1	NTN	
	170,000	39,000	3,67	6316LLB	1	NTN	
	170,000	39,000	3,66	6316LLU	1	NTN	
	170,000	39,000	3,61	6316LU	1	NTN	
170,000	39,000	3,67	6316NR	1-NR	NTN		
170,000	39,000	3,59	6316Z	1	NTN		
170,000	39,000	3,67	6316ZNR	1-NR	NTN		
170,000	39,000	3,53	6316ZZ	1	NTN-SNR		
170,000	39,000	3,74	6316ZZNR	1-NR	NTN		
170,000	39,000	4,12	7316	2	NTN		
170,000	39,000	3,72	7316B	2	NTN		
170,000	39,000	3,74	7316BG	2	NTN		
170,000	39,000	4,15	7316BGM	2	SNR		
170,000	39,000	3,66	7316G	2	NTN		
170,000	39,000	4,52	QJ316N2MA	3	SNR		
170,000	41,000	3,84	SC1610ZZ	1	NTN		
170,000	58,000	5,54	2316S	6	NTN		
170,000	58,000	5,54	2316SK	6	NTN		
170,000	68,000	7,42	51416	34	NTN-SNR		
170,000	68,262	6,17	63316ZZ	1	NTN		
170,000	68,300	6,89	3316	5	SNR		
170,000	68,300	6,17	63316LLU	1	NTN		
170,000	78,000	7,20	6316D2	1	NTN		
170,000	78,000	6,46	7316BDB	2	NTN		
170,000	78,000	7,48	7316BDF	2	NTN		
170,000	78,000	7,46	7316DB	2	NTN		

								Brands	
d	D	B	Kg	Reference					
80,000	170,000	78,000	7,46	7316DF	2	NTN			
	170,000	106,4/81	6,70	EX316G2	8	SNR			
	170,000	106,4/81	6,70	UEL316D1	8	NTN			
	170,000	106,4/81	6,89	UELS316D1N	14	NTN			
	170,000	58/45	5,75	UK316D1	9	NTN			
	170,000	86/44	5,57	UC316G2	7	SNR			
	170,000	86/45	5,55	UC316D1	7	NTN			
	170,000	86/45	5,74	UCS316D1	13	NTN			
	190,000	60/48	7,94	UK318G2H	9	SNR			
	200,000	48,000	6,76	6416	1	NTN			
	200,000	48,000	8,07	6416M	1	SNR			
	200,000	48,000	6,71	7416	2	NTN			
	200,000	48,000	6,71	7416B	2	NTN			
	200,000	48,000	6,71	7416BG	2	NTN			
	280,000	46,000	9,03	6036Z	1	NTN			
	82,000	103,000	11,500	0,18	SF1657	2	NTN		
85,000	110,000	13,000	0,26	6817	1	NTN			
	110,000	13,000	0,26	6817LLB	1	NTN			
	110,000	13,000	0,26	6817LLU	1	NTN			
	110,000	13,000	0,26	6817ZZ	1	NTN			
	110,000	19,000	0,44	51117	34	NTN-SNR			
	120,000	18,000	0,54	6917	1	NTN			
	120,000	18,000	0,53	6917LLU	1	NTN			
	120,000	18,000	0,53	6917NR	1-NR	NTN			
	120,000	18,000	0,53	6917ZZ	1	NTN			
	120,000	18,000	0,63	7917	2	NTN			
	125,000	31,000	1,28	51217	34	NTN-SNR			
	130,000	14,000	0,66	16017	1	NTN-SNR			
	130,000	22,000	0,89	6017	1	NTN-SNR			
	130,000	22,000	0,90	6017EE	1	SNR			
	130,000	22,000	0,88	6017K	1	NTN			
	130,000	22,000	0,91	6017LLB	1	NTN			
	130,000	22,000	0,91	6017LLU	1	NTN			
	130,000	22,000	0,87	6017LU	1	NTN			
	130,000	22,000	0,93	6017NR	1-NR	NTN			
	130,000	22,000	0,97	6017NRZZ	1-NR	SNR			
	130,000	22,000	0,88	6017Z	1	NTN-SNR			
	130,000	22,000	0,91	6017ZNR	1-NR	NTN			
	130,000	22,000	0,91	6017ZZ	1	NTN-SNR			
	130,000	22,000	0,94	6017ZZNR	1-NR	NTN			
	130,000	22,000	1,03	7017	2	NTN			
	130,000	44,000	2,07	7017DB	2	NTN			
	150,000	28,000	2,16	1217	6	SNR			
	150,000	28,000	2,09	1217K	6	SNR			
	150,000	28,000	2,09	1217S	6	NTN			
	150,000	28,000	2,09	1217SK	6	NTN			
	150,000	28,000	1,79	6217	1	NTN-SNR			
	150,000	28,000	1,80	6217EE	1	SNR			
	150,000	28,000	1,79	6217F600	1	SNR			
	150,000	28,000	1,79	6217LB	1	NTN			
	150,000	28,000	1,82	6217LLB	1	NTN			
	150,000	28,000	1,82	6217LLU	1	NTN			
	150,000	28,000	1,80	6217LU	1	NTN			
	150,000	28,000	1,78	6217N	1-NR	SNR			
	150,000	28,000	1,84	6217NR	1-NR	NTN			
	150,000	28,000	1,80	6217Z	1	NTN			
	150,000	28,000	1,85	6217ZNR	1-NR	NTN			
	150,000	28,000	1,81	6217ZZ	1	NTN-SNR			
150,000	28,000	1,85	6217ZZNR	1-NR	NTN				
150,000	28,000	1,78	7217	2	NTN				

								Brands	
d	D	B	Kg	Reference					
85,000	150,000	28,000	1,82	7217B	2	NTN			
	150,000	28,000	1,85	7217BG	2	NTN			
	150,000	28,000	2,05	7217BGM	2	SNR			
	150,000	28,000	3,10	SF1732	2	NTN			
	150,000	28,000	2,18	SF1752	2	NTN			
	150,000	36,000	2,48	2217S	6	NTN			
	150,000	36,000	2,48	2217SK	6	NTN			
	150,000	36,000	2,51	4217A	4	SNR			
	150,000	49,000	3,49	51317	34	NTN			
	150,000	49,200	3,60	3217	5	SNR			
	150,000	49,200	3,40	5217S	5	NTN			
	150,000	56,000	3,71	7217BDB	2	NTN			
	150,000	56,000	3,64	7217DB	2	NTN			
	150,000	56,000	3,56	7217DF	2	NTN			
	150,000	46/36	3,93	UK217D1	9	NTN			
	150,000	73,2/53,2	3,72	EX217G2	8	SNR			
	150,000	85,7/35	3,38	UC217G2	7	SNR			
	150,000	85,7/36	3,37	UC217D1	7	NTN			
	150,000	85,7/36	3,47	UCS217D1	13	NTN			
	160,000	96/37	4,82	UCX17	7	NTN			
	170,000	45,000	4,16	SC1755LLU	1	NTN			
	170,000	45,000	4,16	SX1755LLU	2	NTN			
	171,000	45,000	4,22	SC1757LLU	1	NTN			
	171,000	45,000	4,22	SX1757LLU	2	NTN			
	180,000	41,000	5,05	1317	6	SNR			
	180,000	41,000	4,85	1317K	6	SNR			
	180,000	41,000	5,13	1317S	6	NTN			
	180,000	41,000	5,13	1317SK	6	NTN			
	180,000	41,000	4,23	6317	1	NTN-SNR			
	180,000	41,000	4,32	6317EE	1	SNR			
	180,000	41,000	4,25	6317LLB	1	NTN			
	180,000	41,000	4,25	6317LLU	1	NTN			
	180,000	41,000	4,20	6317LU	1	NTN			
	180,000	41,000	4,31	6317NR	1-NR	NTN			
	180,000	41,000	4,21	6317Z	1	NTN			
	180,000	41,000	4,30	6317ZNR	1-NR	NTN			
	180,000	41,000	4,26	6317ZZ	1	NTN-SNR			
	180,000	41,000	4,34	7317	2	NTN			
	180,000	41,000	4,38	7317B	2	NTN			
	180,000	41,000	4,38	7317BG	2	NTN			
	180,000	41,000	4,88	7317BGM	2	SNR			
	180,000	41,000	5,54	QJ317N2MA	3	SNR			
180,000	60,000	6,56	2317S	6	NTN				
180,000	60,000	6,56	2317SK	6	NTN				
180,000	72,000	8,68	51417	34	NTN				
180,000	73,000	7,34	63317Z	1	NTN				
180,000	82,000	8,76	7317BDB	2	NTN				
180,000	82,000	8,76	7317BDT	2	NTN				
180,000	82,000	8,60	7317DB	2	NTN				
180,000	82,000	8,76	7317DF	2	NTN				
180,000	109,5/84,1	7,96	EX317G2	8	SNR				
180,000	109,5/84,1	8,00	UEL317D1	8	NTN				
180,000	109,5/84,1	8,21	UELS317D1N	14	NTN				
180,000	60/47	6,72	UK317D1	9	NTN				
180,000	96/46	6,84	UC317G2	7	SNR				
180,000	96/47	6,67	UC317D1	7	NTN				
180,000	96/47	6,88	UCS317D1	13	NTN				
200,000	66/50	9,23	UK319G2H	9	SNR				
210,000	52,000	7,98	6417	1	NTN				
210,000	52,000	7,98	7417BG	2	NTN				
88,900	101,600	6,350	0,06	KXA035	3	NTN			

								Brands	
d	D	B	Kg	Reference					
88,900	127,000	19,050	0,75	SC1812	1	NTN			
90,000	115,000	13,000	0,29	6818	1	NTN			
	115,000	13,000	0,27	6818LLB	1	NTN			
	115,000	13,000	0,27	6818LLU	1	NTN			
	115,000	13,000	0,27	6818ZZ	1	NTN			
	120,000	22,000	0,65	51118	34	NTN-SNR			
	125,000	18,000	0,55	6918	1	NTN			
	125,000	18,000	0,56	6918LLB	1	NTN			
	125,000	18,000	0,56	6918LLU	1	NTN			
	125,000	18,000	0,54	6918Z	1	NTN			
	125,000	18,000	0,56	6918ZZ	1	NTN			
	125,000	18,000	0,66	7918	2	NTN			
	125,000	36,000	1,13	6918LLBD2	1	NTN			
	135,000	35,000	1,69	51218	34	NTN			
	140,000	16,000	0,85	16018	1	NTN-SNR			
	140,000	24,000	1,17	6018	1	NTN-SNR			
	140,000	24,000	1,15	6018EE	1	SNR			
	140,000	24,000	1,13	6018LB	1	NTN			
	140,000	24,000	1,17	6018LLB	1	NTN			
	140,000	24,000	1,17	6018LLU	1	NTN			
	140,000	24,000	1,02	6018LLUNR	1-NR	NTN			
	140,000	24,000	1,13	6018LU	1	NTN			
	140,000	24,000	1,17	6018NR	1-NR	NTN-SNR			
	140,000	24,000	1,18	6018NREE	1-NR	SNR			
	140,000	24,000	1,13	6018Z	1	NTN			
	140,000	24,000	1,17	6018ZNR	1-NR	NTN			
	140,000	24,000	1,17	6018ZZ	1	NTN-SNR			
	140,000	24,000	1,21	6018ZZNR	1-NR	NTN			
	140,000	24,000	1,35	7018	2	NTN			
	140,000	24,000	1,33	7018B	2	NTN			
	140,000	48,000	2,66	7018DB	2	NTN			
	155,000	50,000	3,74	51318	34	NTN			
	160,000	30,000	2,55	1218	6	SNR			
	160,000	30,000	2,56	1218K	6	SNR			
	160,000	30,000	2,55	1218S	6	NTN			
	160,000	30,000	2,55	1218SK	6	NTN			
	160,000	30,000	2,11	6218	1	NTN-SNR			
	160,000	30,000	2,23	6218EE	1	SNR			
	160,000	30,000	2,13	6218LB	1	NTN			
	160,000	30,000	2,15	6218LLB	1	NTN			
	160,000	30,000	2,16	6218LLU	1	NTN			
	160,000	30,000	2,13	6218LU	1	NTN			
	160,000	30,000	2,11	6218NR	1-NR	NTN			
	160,000	30,000	2,13	6218Z	1	NTN			
	160,000	30,000	2,19	6218ZNR	1-NR	NTN			
	160,000	30,000	2,11	6218ZZ	1	NTN-SNR			
	160,000	30,000	2,21	6218ZZNR	1-NR	NTN			
	160,000	30,000	2,24	7218	2	NTN			
	160,000	30,000	2,22	7218B	2	NTN			
	160,000	30,000	2,23	7218BG	2	NTN			
	160,000	30,000	2,52	7218BGM	2	SNR			
	160,000	30,000	2,21	7218C	2	NTN			
	160,000	30,000	2,70	QJ218	3	NTN			
160,000	30,000	2,706	QJ218C4U35K	3	NTN				
160,000	30,000	2,700	QJ218CS134	3	NTN				
160,000	30,000	2,707	QJ218CS176U35K	3	NTN				
160,000	40,000	3,28	2218	6	SNR				
160,000	40,000	3,21	2218K	6	SNR				
160,000	40,000	3,13	2218S	6	NTN				
160,000	40,000	3,13	2218SK	6	NTN				
160,000	52,400	4,40	3218	5	SNR				

								Brands	
d	D	B	Kg	Reference					
90,000	160,000	60,000	4,61	6218LLUD2	1	NTN			
	160,000	60,000	4,46	7218BDB	2	NTN			
	160,000	60,000	4,46	7218BDF	2	NTN			
	160,000	60,000	4,48	7218DB	2	NTN			
	160,000	60,000	4,48	7218DF	2	NTN			
	160,000	47/37	4,74	UK218D1	9	NTN			
	160,000	72,5/55	4,90	EX218G2	8	SNR			
	160,000	96/37	4,36	UC218	7	NTN-SNR			
	160,000	96/37	4,46	UCS218D1	13	NTN			
	170,000	104/39	5,51	UCX18	7	NTN			
	190,000	43,000	5,94	1318S	6	NTN			
	190,000	43,000	5,94	1318SK	6	NTN			
	190,000	43,000	5,018	2TS2-7MC3-QJ318L1BC4P6S20	3	NTN			
	190,000	43,000	5,018	2TS2-7MC3-QJ318L1BW-1C4P6S20	3	NTN			
	190,000	43,000	4,90	6318	1	NTN-SNR			
	190,000	43,000	5,02	6318EE	1	SNR			
	190,000	43,000	4,96	6318LLB	1	NTN			
	190,000	43,000	4,96	6318LLU	1	NTN			
	190,000	43,000	4,90	6318LU	1	NTN			
	190,000	43,000	5,00	6318NR	1-NR	NTN			
	190,000	43,000	4,91	6318Z	1	NTN			
	190,000	43,000	5,01	6318ZNR	1-NR	NTN			
	190,000	43,000	4,95	6318ZZ	1	NTN-SNR			
	190,000	43,000	5,06	6318ZZNR	1-NR	NTN			
	190,000	43,000	5,70	7318	2	NTN			
	190,000	43,000	5,09	7318B	2	NTN			
	190,000	43,000	5,09	7318BG	2	NTN			
	190,000	43,000	5,68	7318BGM	2	SNR			
	190,000	43,000	6,44	QJ318N2MA	3	SNR			
	190,000	45,000	5,20	SC1830ZZ	1	NTN			
	190,000	64,000	7,96	2318	6	SNR			
	190,000	64,000	7,66	2318K	6	SNR			
	190,000	64,000	7,76	2318S	6	NTN			
	190,000	64,000	7,76	2318SK	6	NTN			
	190,000	73,000	9,22	3318	5	SNR			
	190,000	77,000	10,20	51418	34	NTN			
	190,000	86,000	10,18	7318BDB	2	NTN			
	190,000	86,000	10,20	7318BDF	2	NTN			
	190,000	86,000	10,54	7318BDT	2	NTN			
	190,000	86,000	10,02	7318DB	2	NTN			
	190,000	86,000	10,00	7318DF	2	NTN			
190,000	172,000	20,36	7318BDBTT	2	NTN				
190,000	215,000	25,80	7318BDTBT	2	NTN				
190,000	115,9/87,3	9,10	EX318G2	8	SNR				
190,000	115,9/87,3	9,10	UELS318D1	8	NTN				
190,000	115,9/87,3	9,34	UELS318D1N	14	NTN				
190,000	64/49	7,87	UK318D1	9	NTN				
190,000	96/48	7,87	UC318G2	7	SNR				
190,000	96/49	7,56	UC318D1	7	NTN				
190,000	96/49	7,80	UCS318D1	13	NTN				
215,000	68/54	10,97	UK320G2H	9	SNR				
225,000	54,000	9,56	6418	1	NTN				
225,000	54,000	9,56	7418BG	2	NTN				
92,075	158,468	39,688	2,90	598/592B	34	NTN			
95,000	120,000	13,000	0,29	6819	1	NTN			
	120,000	13,000	0,28	6819LLB	1	NTN			
	120,000	13,000	0,28	6819LLU	1	NTN			
	120,000	13,000	0,28	6819ZZ	1	NTN			
	130,000	18,000	0,58	6919	1	NTN			
	130,000	18,000	0,59	6919LLB	1	NTN			

								Brands	
d	D	B	Kg	Reference					
95,000	130,000	18,000	0,58	6919LLU	1	NTN			
	130,000	18,000	0,58	6919LUZ	1	NTN			
	130,000	18,000	0,58	6919ZZ	1	NTN			
	130,000	18,000	0,58	7919	2	NTN			
	145,000	16,000	0,92	16019	1	NTN			
	145,000	24,000	1,08	6019	1	NTN-SNR			
	145,000	24,000	1,22	6019EE	1	SNR			
	145,000	24,000	1,22	6019LLB	1	NTN			
	145,000	24,000	1,22	6019LLU	1	NTN			
	145,000	24,000	1,18	6019LU	1	NTN			
	145,000	24,000	1,27	6019NR	1-NR	NTN			
	145,000	24,000	1,18	6019Z	1	NTN			
	145,000	24,000	1,22	6019ZNR	1-NR	NTN			
	145,000	24,000	1,20	6019ZZ	1	NTN-SNR			
	145,000	24,000	1,22	6019ZZNR	1-NR	NTN			
	145,000	24,000	1,20	7019	2	NTN			
	145,000	48,000	2,82	7019DB	2	NTN			
	145,000	48,000	2,82	7019DF	2	NTN			
	145,000	72,000	3,66	7019BDBT	2	NTN			
	170,000	32,000	3,16	1219	6	SNR			
	170,000	32,000	3,12	1219K	6	SNR			
	170,000	32,000	3,21	1219S	6	NTN			
	170,000	32,000	3,21	1219SK	6	NTN			
	170,000	32,000	2,62	6219	1	NTN-SNR			
	170,000	32,000	2,77	6219EE	1	SNR			
	170,000	32,000	2,61	6219LLB	1	NTN			
	170,000	32,000	2,61	6219LLU	1	NTN			
	170,000	32,000	2,70	6219NR	1-NR	NTN			
	170,000	32,000	2,57	6219Z	1	NTN-SNR			
	170,000	32,000	2,60	6219ZZ	1	NTN-SNR			
	170,000	32,000	2,70	6219ZZNR	1-NR	NTN			
	170,000	32,000	2,67	7219	2	NTN			
	170,000	32,000	2,72	7219B	2	NTN			
	170,000	32,000	2,74	7219BG	2	NTN			
	170,000	32,000	3,04	7219BGM	2	SNR			
	170,000	32,000	3,350	TA-QJ219BCS236U35K	3	NTN			
	170,000	32,000	2,625	TM-QJ219BCS236U35K	3	NTN			
	170,000	43,000	3,87	2219S	6	NTN			
	170,000	43,000	3,87	2219SK	6	NTN			
	170,000	64,000	4,48	7219BDB	2	NTN			
	170,000	64,000	4,48	7219BDF	2	NTN			
	170,000	64,000	5,34	7219DB	2	NTN			
	170,000	64,000	5,34	7219DF	2	NTN			
	200,000	45,000	6,84	1319S	6	NTN			
	200,000	45,000	6,84	1319SK	6	NTN			
	200,000	45,000	5,67	6319	1	NTN-SNR			
	200,000	45,000	5,85	6319LLB	1	NTN			
	200,000	45,000	5,83	6319LLU	1	NTN			
	200,000	45,000	5,77	6319NR	1-NR	NTN			
	200,000	45,000	5,74	6319Z	1	NTN			
200,000	45,000	5,82	6319ZZ	1	NTN-SNR				
200,000	45,000	5,89	7319	2	NTN				
200,000	45,000	6,00	7319B	2	NTN				
200,000	45,000	5,80	7319BG	2	NTN				
200,000	45,000	6,24	7319BGM	2	SNR				
200,000	67,000	9,01	2319S	6	NTN				
200,000	67,000	9,01	2319SK	6	NTN				
200,000	90,000	11,84	6319D2	1	NTN				
200,000	90,000	11,84	7319BDB	2	NTN				
200,000	90,000	11,60	7319DB	2	NTN				
200,000	103/50	8,91	UC319G2	7	SNR				
200,000	103/51	8,70	UC319D1	7	NTN				

								Brands	
d	D	B	Kg	Reference					
95,000	200,000	103/51	8,97	UCS319D1	13	NTN			
	200,000	122,3/93,7	10,40	EX319G2	8	SNR			
	200,000	122,3/93,7	10,40	UEL319D1	8	NTN			
	200,000	67/51	9,02	UK319D1	9	NTN			
100,000	125,000	13,000	0,31	6820	1	NTN			
	125,000	13,000	0,30	6820LLB	1	NTN			
	125,000	13,000	0,30	6820LLU	1	NTN			
	125,000	13,000	0,29	6820ZZ	1	NTN			
	125,000	13,000	0,36	7820	2	NTN			
	135,000	25,000	0,96	51120	34	NTN-SNR			
	140,000	20,000	0,78	6920	1	NTN			
	140,000	20,000	0,79	6920LLB	1	NTN			
	140,000	20,000	0,80	6920LLU	1	NTN			
	140,000	20,000	0,81	6920NR	1-NR	NTN			
	140,000	20,000	0,78	6920Z	1	NTN			
	140,000	20,000	0,79	6920ZZ	1	NTN			
	140,000	20,000	0,93	7920	2	NTN			
	140,000	40,000	1,87	7920CDF	2	NTN			
	140,000	40,000	1,87	7920DB	2	NTN			
	150,000	16,000	0,91	16020	1	NTN-SNR			
	150,000	16,000	0,99	SF2052LB	2	NTN			
	150,000	24,000	1,27	6020	1	NTN-SNR			
	150,000	24,000	1,28	6020EE	1	SNR			
	150,000	24,000	1,26	6020LLB	1	NTN			
	150,000	24,000	1,26	6020LLU	1	NTN			
	150,000	24,000	1,23	6020LU	1	NTN			
	150,000	24,000	1,31	6020NR	1-NR	NTN-SNR			
	150,000	24,000	1,23	6020Z	1	NTN			
	150,000	24,000	1,27	6020ZNR	1-NR	NTN			
	150,000	24,000	1,26	6020ZZ	1	NTN-SNR			
	150,000	24,000	1,30	6020ZZNR	1-NR	NTN			
	150,000	24,000	1,47	7020	2	NTN			
	150,000	24,000	1,49	7020B	2	NTN			
	150,000	38,000	2,23	51220	34	NTN			
	150,000	48,000	2,86	7020DB	2	NTN			
	170,000	55,000	4,97	51320	34	NTN			
	170,000	60,300	5,64	DE2010	5	NTN			
	180,000	34,000	3,77	1220	6	SNR			
	180,000	34,000	3,71	1220K	6	SNR			
180,000	34,000	3,82	1220S	6	NTN				
180,000	34,000	3,82	1220SK	6	NTN				
180,000	34,000	3,09	6220	1	NTN-SNR				
180,000	34,000	3,22	6220EE	1	SNR				
180,000	34,000	3,13	6220LLB	1	NTN				
180,000	34,000	1,32	6220LLU	1	NTN				
180,000	34,000	3,09	6220LU	1	NTN				
180,000	34,000	3,07	6220NR	1-NR	NTN				
180,000	34,000	3,14	6220NR	1-NR	NTN				
180,000	34,000	3,04	6220Z	1	NTN				
180,000	34,000	3,01	6220ZZ	1	NTN-SNR				
180,000	34,000	3,23	6220ZZNR	1-NR	NTN				
180,000	34,000	3,20	7220	2	NTN				
180,000	34,000	3,24	7220B	2	NTN				
180,000	34,000	2,97	7220BBG	2	NTN				
180,000	34,000	3,24	7220BG	2	NTN				
180,000	34,000	3,67	7220BGM	2	SNR				
180,000	34,000	3,95	QJ220	3	NTN				
180,000	34,000	3,951	QJ220C3	3	NTN				
180,000	46,000	4,80	2220	6	SNR				
180,000	46,000	4,72	2220K	6	SNR				
180,000	46,000	4,53	2220S	6	NTN				

								Brands		
d	D	B	Kg	Reference						
100,000	180,000	46,000	4,53	2220SK	6	NTN				
	180,000	68,000	6,20	6220D2	1	NTN				
	180,000	68,000	6,48	7220BDB	2	NTN				
	180,000	68,000	6,40	7220DB	2	NTN				
	180,000	68,000	6,40	7220DF	2	NTN				
	190,000	117,5/44	8,95	UCX20	7	NTN				
	203,000	52,000	6,49	SX2059LLU	2	NTN				
	205,000	52,000	6,80	SX2057LLU	2	NTN				
	210,000	85,000	13,70	51420	34	NTN				
	215,000	47,000	8,70	1320	6	SNR				
	215,000	47,000	8,30	1320K	6	SNR				
	215,000	47,000	8,46	1320S	6	NTN				
	215,000	47,000	8,46	1320SK	6	NTN				
	215,000	47,000	7,08	6320	1	NTN-SNR				
	215,000	47,000	7,19	6320LLB	1	NTN				
	215,000	47,000	7,19	6320LLU	1	NTN				
	215,000	47,000	7,10	6320Z	1	NTN				
	215,000	47,000	7,00	6320ZZ	1	NTN-SNR				
	215,000	47,000	8,10	7320	2	NTN				
	215,000	47,000	7,34	7320B	2	NTN				
	215,000	47,000	7,32	7320BBG	2	NTN				
	215,000	47,000	7,34	7320BG	2	NTN				
	215,000	47,000	8,19	7320BGM	2	SNR				
	215,000	47,000	6,90	7320C	2	NTN				
	215,000	47,000	9,14	QJ320	3	NTN				
	215,000	47,000	9,140	QJ320WC4	3	NTN				
	215,000	73,000	11,60	2320S	6	NTN				
	215,000	73,000	11,60	2320SK	6	NTN				
	215,000	82,500	12,14	63320ZZ	1	NTN				
	215,000	82,600	13,60	63320LLB	1	NTN				
	215,000	94,000	14,68	7320BDB	2	NTN				
	215,000	94,000	13,80	7320CDB	2	NTN				
	215,000	94,000	14,36	7320DB	2	NTN				
	215,000	94,000	14,36	7320DF	2	NTN				
	215,000	94,000	14,20	7320DT	2	NTN				
	215,000	141,000	21,96	7320BDBT	2	NTN				
	215,000	108/54	11,20	UC320G2	7	SNR				
	215,000	108/55	10,80	UC320D1	7	NTN				
	215,000	108/55	11,10	UCS320D1	13	NTN				
	215,000	128,6/100	13,00	EX320G2	8	SNR				
	215,000	128,6/100	12,50	UEL320D1	8	NTN				
	215,000	73/55	11,10	UK320D1	9	NTN				
	240,000	80/60	17,64	UK322G2H	9	SNR				
	250,000	58,000	13,06	6420	1	NTN				
	101,600	134,938	15,875	0,50	SF2091	2	NTN			
		142,870	22,220	0,95	SC2010	1	NTN			
	105,000	130,000	13,000	0,31	6821	1	NTN			
130,000		13,000	0,31	6821LLU	1	NTN				
130,000		13,000	0,30	6821ZZ	1	NTN				
130,000		13,000	0,37	7821	2	NTN				
138,000		15,000	0,95	SF2118	2	NTN				
145,000		20,000	0,84	6921	1	NTN				
145,000		20,000	0,84	6921LLB	1	NTN				
145,000		20,000	0,84	6921LLU	1	NTN				
145,000		20,000	0,83	6921ZZ	1	NTN				
145,000		20,000	0,97	7921	2	NTN				
160,000		18,000	1,23	16021	1	NTN				
160,000		26,000	1,58	6021	1	NTN-SNR				
160,000		26,000	1,61	6021EE	1	SNR				
160,000		26,000	1,60	6021LLB	1	NTN				

								Brands		
d	D	B	Kg	Reference						
105,000	160,000	26,000	1,59	6021LLU	1	NTN				
	160,000	26,000	1,59	6021LU	1	NTN				
	160,000	26,000	1,59	6021Z	1	NTN				
	160,000	26,000	1,60	6021ZZ	1	NTN				
	160,000	26,000	1,64	6021ZZNR	1-NR	NTN				
	160,000	26,000	1,86	7021	2	NTN				
	160,000	26,000	1,88	7021B	2	NTN				
	160,000	26,000	1,86	SF2109	2	NTN				
	160,000	52,000	3,72	7021DB	2	NTN				
	180,000	32,000	2,85	SF2110	2	NTN				
	190,000	36,000	4,52	1221S	6	NTN				
	190,000	36,000	3,70	6221	1	NTN-SNR				
	190,000	36,000	3,76	6221LLB	1	NTN				
	190,000	36,000	3,76	6221LLU	1	NTN				
	190,000	36,000	3,77	6221LLUNR	1-NR	NTN				
	190,000	36,000	3,79	6221NR	1-NR	NTN				
	190,000	36,000	3,69	6221Z	1	NTN				
	190,000	36,000	3,78	6221ZNR	1-NR	NTN				
	190,000	36,000	3,74	6221ZZ	1	NTN				
	190,000	36,000	3,79	7221	2	NTN				
	190,000	36,000	3,87	7221B	2	NTN				
	190,000	36,000	4,35	7221BG	2	NTN				
	190,000	50,000	5,64	2221S	6	NTN				
	190,000	72,000	7,74	7221BDB	2	NTN				
	190,000	72,000	7,75	7221DB	2	NTN				
	190,000	72,000	7,78	7221DF	2	NTN				
	225,000	49,000	10,00	1321S	6	NTN				
	225,000	49,000	8,05	6321	1	NTN				
	225,000	49,000	8,19	6321LLU	1	NTN				
	225,000	49,000	8,05	6321Z	1	NTN				
	225,000	49,000	8,19	6321ZZ	1	NTN				
	225,000	49,000	8,20	7321	2	NTN				
	225,000	49,000	8,36	7321B	2	NTN				
	225,000	49,000	8,08	7321BG	2	NTN				
	225,000	49,000	9,34	7321BGM	2	SNR				
	225,000	49,000	10,40	QJ321	3	NTN				
	225,000	49,000	10,400	QJ321WC4	3	NTN				
	225,000	77,000	14,40	2321S	6	NTN				
	225,000	98,000	16,72	7321BDB	2	NTN				
	225,000	98,000	16,42	7321DB	2	NTN				
	225,000	112/57	12,20	UC321	7	NTN-SNR				
	225,000	112/57	12,60	UCS321D1	13	NTN				
	225,000	139,7/104,8	14,60	UEL321D1	8	NTN				
	107,950	120,650	6,350	0,09	KXA042	3	NTN			
	109,000	138,000	13,000	0,39	SF2255	2	NTN			
		138,000	13,000	0,39	SF2263	2	NTN			
110,000	140,000	16,000	0,51	6822	1	NTN				
	140,000	16,000	0,50	6822LLB	1	NTN				
	140,000	16,000	0,50	6822LLU	1	NTN				
	140,000	16,000	0,49	6822ZZ	1	NTN				
	140,000	16,000	0,58	7822	2	NTN				
	145,000	25,000	1,04	51122	34	NTN-SNR				
	150,000	20,000	0,85	6922	1	NTN				
	150,000	20,000	0,86	6922LLB	1	NTN				
	150,000	20,000	0,87	6922LLU	1	NTN				
	150,000	20,000	0,87	6922Z	1	NTN				
	150,000	20,000	0,86	6922ZZ	1	NTN				
	150,000	20,000	1,01	7922	2	NTN				
	160,000	38,000	2,42	51222	34	NTN				

								Brands	
d	D	B	Kg	Reference					
110,000	169,500	56,000	4,61	DE2208	5	NTN			
	170,000	19,000	1,46	16022	1	NTN-SNR			
	170,000	28,000	1,96	6022	1	NTN-SNR			
	170,000	28,000	2,03	6022EE	1	SNR			
	170,000	28,000	1,96	6022K	1	NTN			
	170,000	28,000	1,98	6022LLB	1	NTN			
	170,000	28,000	1,98	6022LLU	1	NTN			
	170,000	28,000	1,96	6022LU	1	NTN			
	170,000	28,000	2,04	6022NR	1-NR	NTN			
	170,000	28,000	1,94	6022Z	1	NTN			
	170,000	28,000	2,05	6022ZNR	1-NR	NTN			
	170,000	28,000	1,98	6022ZZ	1	NTN			
	170,000	28,000	2,06	6022ZZNR	1-NR	NTN			
	170,000	28,000	2,30	7022	2	NTN			
	170,000	28,000	2,34	7022B	2	NTN			
	170,000	56,000	4,56	7022DB	2	NTN			
	170,000	56,000	4,42	7022DF	2	NTN			
	170,000	84,000	5,94	7022BDBT	2	NTN			
	190,000	63,000	7,25	51322	34	NTN			
	200,000	38,000	5,21	1222	6	SNR			
	200,000	38,000	5,16	1222K	6	SNR			
	200,000	38,000	5,33	1222S	6	NTN			
	200,000	38,000	5,33	1222SK	6	NTN			
	200,000	38,000	4,38	6222	1	NTN-SNR			
	200,000	38,000	4,42	6222LLB	1	NTN			
	200,000	38,000	4,42	6222LLU	1	NTN			
	200,000	38,000	4,48	6222LLUNR	1-NR	NTN			
	200,000	38,000	4,35	6222LU	1	NTN			
	200,000	38,000	4,46	6222NR	1-NR	NTN			
	200,000	38,000	4,37	6222Z	1	NTN			
	200,000	38,000	4,42	6222ZZ	1	NTN			
	200,000	38,000	4,41	7222	2	NTN			
	200,000	38,000	4,54	7222B	2	NTN			
	200,000	38,000	4,48	7222BBG	2	NTN			
	200,000	38,000	4,56	7222BGG	2	NTN			
	200,000	38,000	5,07	7222BGM	2	SNR			
	200,000	38,000	5,52	QJ222	3	NTN			
	200,000	38,000	5,620	QJ222BWC3S30	3	NTN			
	200,000	38,000	5,524	QJ222X50C3	3	NTN			
	200,000	38,000	4,48	SF2254	2	NTN			
	200,000	53,000	6,64	2222S	6	NTN			
	200,000	53,000	6,64	2222SK	6	NTN			
	200,000	76,000	9,12	7222BDB	2	NTN			
	200,000	76,000	8,82	7222BDF	2	NTN			
	200,000	76,000	8,98	7222DB	2	NTN			
	200,000	76,000	8,98	7222DF	2	NTN			
	200,000	114,000	15,43	7222BDFB	2	NTN			
	240,000	50,000	12,00	1322S	6	NTN			
	240,000	50,000	12,00	1322SK	6	NTN			
	240,000	50,000	9,54	6322	1	NTN-SNR			
	240,000	50,000	9,54	6322LLB	1	NTN			
	240,000	50,000	9,66	6322LLU	1	NTN			
	240,000	50,000	9,56	6322Z	1	NTN			
	240,000	50,000	9,64	6322ZZ	1	NTN			
	240,000	50,000	9,47	7322	2	NTN			
	240,000	50,000	9,95	7322B	2	NTN			
	240,000	50,000	11,20	7322BBG	2	NTN			
	240,000	50,000	9,95	7322BGG	2	NTN			
	240,000	50,000	11,22	7322BGM	2	SNR			
240,000	50,000	9,59	7322C	2	NTN				
240,000	80,000	17,40	2322S	6	NTN				
240,000	80,000	17,40	2322SK	6	NTN				

								Brands		
d	D	B	Kg	Reference						
110,000	240,000	100,000	19,80	6322D2	1	NTN				
	240,000	100,000	19,60	7322BDB	2	NTN				
	240,000	100,000	22,00	7322BDT	2	NTN				
	240,000	100,000	19,18	7322CDB	2	NTN				
	240,000	100,000	10,75	7322DB	2	NTN				
	240,000	100,000	21,40	7322DF	2	NTN				
	240,000	117/59	14,30	UC322D1	7	NTN				
	240,000	117/59	14,70	UCS322D1	13	NTN				
	240,000	117/60	14,30	UC322G2	7	SNR				
	240,000	141,3/106,4	17,20	UEL322D1	8	NTN				
	240,000	80/59	14,90	UK322D1	9	NTN				
	260,000	86/64	21,19	UK324G2H	9	SNR				
	114,300	127,000	6,350	0,10	KYA045	2	NTN			
		133,350	9,525	0,21	KRC045	1	NTN			
		158,720	22,220	1,12	SC2308	1	NTN			
	115,000	280,000	92/68	27,90	UK326G2H	9	SNR			
	120,000	150,000	16,000	0,55	6824	1	NTN			
		150,000	16,000	0,54	6824LLU	1	NTN			
		150,000	16,000	0,55	6824NR	1-NR	NTN			
		150,000	16,000	0,52	6824ZZ	1	NTN			
150,000		16,000	0,63	7824	2	NTN				
155,000		25,000	1,21	51124	34	NTN-SNR				
165,000		22,000	1,19	6924	1	NTN				
165,000		22,000	1,19	6924LLU	1	NTN				
165,000		22,000	1,19	6924NR	1-NR	NTN				
165,000		22,000	1,19	6924ZZ	1	NTN				
165,000		22,000	1,19	7924	2	NTN				
165,000		44,000	2,69	7924DB	2	NTN				
170,000		39,000	2,66	51224	34	NTN				
180,000		19,000	1,58	16024	1	NTN-SNR				
180,000		19,000	1,42	16024N	1-NR	NTN				
180,000		28,000	2,10	6024	1	NTN-SNR				
180,000		28,000	2,19	6024E	1	SNR				
180,000		28,000	2,15	6024EE	1	SNR				
180,000		28,000	2,03	6024LLB	1	NTN				
180,000		28,000	2,13	6024LLU	1	NTN				
180,000		28,000	2,11	6024LU	1	NTN				
180,000		28,000	2,16	6024NR	1-NR	NTN-SNR				
180,000		28,000	2,10	6024Z	1	NTN				
180,000		28,000	2,12	6024ZZ	1	NTN				
180,000		28,000	2,20	6024ZZNR	1-NR	NTN				
180,000		28,000	2,36	7024	2	NTN				
180,000		28,000	2,51	7024B	2	NTN				
180,000	56,000	4,73	7024DB	2	NTN					
180,000	56,000	4,73	7024DF	2	NTN					
190,000	66,000	7,09	DE2405	5	NTN					
190,000	66,000	7,09	DE2409	5	NTN					
210,000	70,000	9,88	51324	34	NTN					
215,000	40,000	5,15	6224	1	NTN-SNR					
215,000	40,000	5,32	6224LLB	1	NTN					
215,000	40,000	5,32	6224LLU	1	NTN					
215,000	40,000	5,27	6224Z	1	NTN					
215,000	40,000	5,35	6224ZZ	1	NTN					
215,000	40,000	6,26	7224	2	NTN					
215,000	40,000	6,21	7224B	2	NTN					
215,000	40,000	6,21	7224BG	2	NTN					
215,000	40,000	6,10	7224BGM	2	SNR					
215,000	40,000	5,35	7224C	2	NTN					
215,000	40,000	6,56	QJ224	3	NTN					

				Brands		
d	D	B	Kg	Reference		
120,000	215,000	40,000	6,599	QJ224ACS155	3	NTN
	215,000	40,000	6,560	QJ224C3U35K	3	NTN
	215,000	40,000	6,750	QJ224WC4	3	NTN
	215,000	40,000	6,560	TM-QJ224CCS256U35K	3	NTN
	215,000	80,000	12,52	7224BDB	2	NTN
	215,000	80,000	12,52	7224BDF	2	NTN
	215,000	80,000	10,70	7224CDB	2	NTN
	215,000	80,000	12,02	7224DB	2	NTN
	215,000	80,000	12,02	7224DF	2	NTN
	215,000	160,000	20,64	7224CDTBT	2	NTN
	245,000	66,000	12,70	SX2453LLU	2	NTN
	260,000	55,000	12,40	6324	1	NTN
	260,000	55,000	12,70	6324LLU	1	NTN
	260,000	55,000	14,48	6324M	1	SNR
	260,000	55,000	12,40	6324Z	1	NTN
	260,000	55,000	12,70	6324ZZ	1	NTN
	260,000	55,000	14,70	7324	2	NTN
	260,000	55,000	13,00	7324B	2	NTN
	260,000	55,000	14,50	7324BG	2	NTN
	260,000	55,000	14,20	7324BGM	2	SNR
	260,000	110,000	29,00	7324BDB	2	NTN
	260,000	110,000	29,00	7324BDT	2	NTN
	260,000	110,000	28,20	7324DB	2	NTN
	260,000	126/63	18,50	UC324D1	7	NTN
	260,000	126/63	19,00	UCS324D1	13	NTN
260,000	126/64	18,50	UC324G2	7	SNR	
260,000	86/63	18,00	UK324D1	9	NTN	
125,000	209,000	33,000	4,70	SE2501	2	NTN
	300,000	98/73	34,45	UK328G2H	9	SNR
126,000	154,000	14,400	0,44	SF2518	2	NTN
130,000	165,000	18,000	0,77	6826	1	NTN
	165,000	18,000	0,74	6826LLB	1	NTN
	165,000	18,000	0,75	6826LLU	1	NTN
	165,000	18,000	0,72	6826ZZ	1	NTN
	165,000	18,000	0,91	7826	2	NTN
	170,000	30,000	1,64	51126	34	NTN-SNR
	180,000	24,000	1,52	6926	1	NTN
	180,000	24,000	1,56	6926LLU	1	NTN
	180,000	24,000	1,54	6926LU	1	NTN
	180,000	24,000	1,55	6926LUZ	1	NTN
	180,000	24,000	1,54	6926Z	1	NTN
	180,000	24,000	1,55	6926ZZ	1	NTN
	180,000	24,000	1,82	7926	2	NTN
	190,000	45,000	4,08	51226	34	NTN
	199,500	33,000	3,74	SF2652	2	NTN
	200,000	22,000	2,31	16026	1	NTN-SNR
	200,000	33,000	3,16	6026	1	NTN-SNR
	200,000	33,000	3,19	6026LLB	1	NTN
	200,000	33,000	3,28	6026LLU	1	NTN
	200,000	33,000	3,19	6026NR	1-NR	NTN
	200,000	33,000	3,19	6026Z	1	NTN
	200,000	33,000	3,27	6026ZZ	1	NTN
	200,000	33,000	3,26	6026ZZNR	1-NR	NTN
	200,000	33,000	3,73	7026	2	NTN
	200,000	33,000	3,78	7026B	2	NTN
200,000	66,000	7,38	7026BDB	2	NTN	
200,000	66,000	7,14	7026DB	2	NTN	
200,000	66,000	7,54	DE2601	5	NTN	
205,000	24,000	2,98	SF2608	2	NTN	

				Brands			
d	D	B	Kg	Reference			
130,000	215,000	36,000	4,90	SE2612	2	NTN	
	220,000	75,000	12,70	51326	34	NTN	
	230,000	40,000	5,91	6226	1	NTN-SNR	
	230,000	40,000	5,98	6226LLU	1	NTN	
	230,000	40,000	5,90	6226Z	1	NTN	
	230,000	40,000	5,97	6226ZZ	1	NTN	
	230,000	40,000	7,15	7226	2	NTN	
	230,000	40,000	6,95	7226B	2	NTN	
	230,000	40,000	6,95	7226BG	2	NTN	
	230,000	40,000	6,98	7226BGM	2	SNR	
	230,000	40,000	5,83	7226C	2	NTN	
	230,000	40,000	7,50	QJ226	3	NTN	
	230,000	40,000	7,750	QJ226WC4P36	3	NTN	
	230,000	40,000	7,640	TM-QJ226BC3	3	NTN	
	230,000	80,000	13,90	7226BDF	2	NTN	
	230,000	80,000	11,66	7226CDB	2	NTN	
	230,000	80,000	14,30	7226DB	2	NTN	
	230,000	80,000	13,60	7226DF	2	NTN	
	280,000	58,000	15,30	6326	1	NTN	
	280,000	58,000	15,50	6326LLU	1	NTN	
	280,000	58,000	18,12	6326M	1	SNR	
	280,000	58,000	15,20	6326Z	1	NTN	
	280,000	58,000	15,30	6326ZZ	1	NTN	
	280,000	58,000	17,70	7326	2	NTN	
	280,000	58,000	17,60	7326B	2	NTN	
	280,000	58,000	17,70	7326BG	2	NTN	
	280,000	58,000	17,53	7326BGM	2	SNR	
	280,000	116,000	35,20	7326BDB	2	NTN	
	280,000	116,000	35,10	7326BDF	2	NTN	
	280,000	116,000	35,20	7326BDT	2	NTN	
	280,000	116,000	34,00	7326DB	2	NTN	
	280,000	135/67	23,00	UC326D1	7	NTN	
	280,000	135/67	23,60	UCS326D1	13	NTN	
	280,000	135/68	23,00	UC326G2	7	SNR	
	280,000	90/67	23,30	UK326D1	9	NTN	
	340,000	78,000	32,00	6426	1	NTN	
	139,700	158,750	9,525	0,25	KRC055	1	NTN
		158,750	12,700	0,34	KRJ055LL	1	NTN
	140,000	175,000	18,000	0,85	6828	1	NTN
		175,000	18,000	0,80	6828LLU	1	NTN
175,000		18,000	0,81	6828ZZ	1	NTN	
175,000		18,000	0,97	7828	2	NTN	
175,000		18,000	0,83	SF2812V	2	NTN	
175,000		18,000	0,73	SF2853	2	NTN	
175,000		18,000	0,73	SF2855	2	NTN	
180,000		31,000	1,78	51128	34	NTN	
190,000		24,000	1,62	6928	1	NTN	
190,000		24,000	1,64	6928LLU	1	NTN	
190,000		24,000	1,67	6928LU	1	NTN	
190,000		24,000	1,65	6928ZZ	1	NTN	
190,000		24,000	1,94	7928	2	NTN	
200,000		46,000	4,43	51228	34	NTN	
210,000		22,000	2,48	16028	1	NTN-SNR	
210,000		33,000	3,49	6028	1	NTN-SNR	
210,000		33,000	3,62	6028EE	1	SNR	
210,000		33,000	3,49	6028LLU	1	NTN	
210,000		33,000	3,35	6028LU	1	NTN	
210,000		33,000	3,30	6028Z	1	NTN	
210,000	33,000	3,48	6028ZZ	1	NTN		
210,000	33,000	3,80	7028	2	NTN		



										Brands	
d	D	B	Kg	Reference							
140,000	210,000	33,000	4,01	7028B	2	NTN					
	210,000	33,000	3,96	7028BG	2	NTN					
	210,000	33,000	3,79	7028C	2	NTN					
	210,000	33,000	3,79	7028CG	2	NTN					
	210,000	33,000	7,92	7028DB	2	NTN					
	210,000	66,000	7,58	7028CDB	2	NTN					
	210,000	66,000	7,92	7028T1DT	2	NTN					
	210,000	66,000	7,76	DE2806	5	NTN					
	210,000	66,000	7,72	DE2807	5	NTN					
	210,000	66,000	8,00	DE2812	5	NTN					
	210,000	69,000	7,04	742028	35	NTN					
	240,000	80,000	14,50	51328	34	NTN					
	250,000	42,000	7,57	6228	1	NTN-SNR					
	250,000	42,000	6,20	6228LLU	1	NTN					
	250,000	42,000	7,54	6228Z	1	NTN					
	250,000	42,000	7,62	6228ZZ	1	NTN					
	250,000	42,000	8,78	7228	2	NTN					
	250,000	42,000	8,78	7228B	2	NTN					
	250,000	42,000	8,78	7228BG	2	NTN					
	250,000	42,000	8,86	7228BGM	2	SNR					
	250,000	42,000	7,30	7228C	2	NTN					
	250,000	42,000	9,720	QJ228WC4	3	NTN					
	250,000	46,000	9,83	SC2852Z	1	NTN					
	250,000	84,000	17,56	7228BDB	2	NTN					
	250,000	84,000	17,56	7228BDF	2	NTN					
	250,000	84,000	17,52	7228DB	2	NTN					
	250,000	84,000	17,56	7228DF	2	NTN					
	250,000	84,000	17,56	7228DT	2	NTN					
	250,000	126,000	26,30	7228DFT	2	NTN					
	300,000	62,000	18,50	6328	1	NTN					
	300,000	62,000	21,60	6328B	1	NTN					
	300,000	62,000	18,80	6328LLU	1	NTN					
	300,000	62,000	22,10	6328M	1	SNR					
	300,000	62,000	18,52	6328Z	1	NTN					
	300,000	62,000	18,60	6328ZZ	1	NTN					
	300,000	62,000	21,50	7328	2	NTN					
	300,000	62,000	21,50	7328B	2	NTN					
	300,000	62,000	21,60	7328BG	2	NTN					
	300,000	62,000	21,42	7328BGM	2	SNR					
	300,000	124,000	43,00	7328BDB	2	NTN					
300,000	145/71	28,50	UC328D1	7	NTN						
300,000	145/71	29,20	UCS328D1	13	NTN						
300,000	145/73	28,50	UC328G2	7	SNR						
300,000	95/71	28,90	UK328D1	9	NTN						
143,000	175,000	16,000	0,44	SF2907	2	NTN					
144,000	174,000	15,300	0,58	SF2917	2	NTN					
145,000	200,000	27,000	1,77	SF2912	2	NTN					
	220,000	38,000	5,07	SC2951	1	NTN					
	220,000	38,000	5,15	SF2951	2	NTN					
149,000	183,000	16,500	0,77	SF3050	2	NTN					
	183,000	17,300	0,80	SF3048	2	NTN					
150,000	190,000	20,000	1,13	6830	1	NTN					
	190,000	20,000	1,12	6830ZZ	1	NTN					
	190,000	20,000	1,35	7830	2	NTN					
	190,000	31,000	1,93	51130	34	NTN-SNR					
	210,000	28,000	2,47	6930	1	NTN					
	210,000	28,000	2,57	6930LLU	1	NTN					

										Brands	
d	D	B	Kg	Reference							
150,000	210,000	28,000	2,47	6930Z	1	NTN					
	210,000	28,000	2,55	6930ZZ	1	NTN					
	210,000	28,000	2,96	7930	2	NTN					
	210,000	28,000	2,84	7930C	2	NTN					
	210,000	28,000	2,70	7930CG	2	NTN					
	210,000	56,000	5,40	7930CDB	2	NTN					
	210,000	56,000	5,69	7930DB	2	NTN					
	215,000	50,000	5,71	51230	34	NTN					
	225,000	24,000	3,07	16030	1	NTN					
	225,000	35,000	4,08	6030	1	NTN-SNR					
	225,000	35,000	4,15	6030LLB	1	NTN					
	225,000	35,000	4,26	6030LLU	1	NTN					
	225,000	35,000	4,22	6030Z	1	NTN					
	225,000	35,000	4,16	6030ZZ	1	NTN					
	225,000	35,000	4,82	7030	2	NTN					
	225,000	35,000	4,88	7030B	2	NTN					
	225,000	35,000	4,61	7030C	2	NTN					
	225,000	35,000	4,61	7030CG	2	NTN					
	225,000	70,000	9,21	7030CDB	2	NTN					
	225,000	70,000	9,21	7030CDT	2	NTN					
	225,000	70,000	9,24	7030DB	2	NTN					
	225,000	70,000	9,74	DE3010	5	NTN					
	225,000	70,000	9,74	DE3011	5	NTN					
	225,000	70,000	9,03	SF3033DB	2	NTN					
	225,000	73,000	9,69	DE3009	5	NTN					
	225,000	75,000	8,78	742030	35	NTN					
	225,000	105,000	13,82	7030CDBT	2	NTN					
	225,000	140,000	18,43	7030CDTBT	2	NTN					
	230,000	35,000	5,51	SC3002	1	NTN					
	230,000	35,000	5,18	SC3007	1	NTN					
	230,000	70,000	9,74	DE3007	5	NTN					
	230,000	70,000	9,74	DE3019	5	NTN					
	250,000	80,000	15,30	51330	34	NTN					
	270,000	45,000	9,41	6230	1	NTN-SNR					
	270,000	45,000	10,06	6230LLU	1	NTN					
	270,000	45,000	9,94	6230Z	1	NTN					
	270,000	45,000	10,04	6230ZZ	1	NTN					
	270,000	45,000	11,20	7230	2	NTN					
	270,000	45,000	11,30	7230B	2	NTN					
	270,000	45,000	11,30	7230BG	2	NTN					
270,000	45,000	11,40	7230BGM	2	SNR						
270,000	45,000	11,10	7230C	2	NTN						
320,000	65,000	23,00	6330	1	NTN						
320,000	65,000	26,60	6330M	1	SNR						
320,000	65,000	23,00	6330Z	1	NTN						
320,000	65,000	23,30	6330ZZ	1	NTN						
320,000	65,000	25,10	7330	2	NTN						
320,000	65,000	25,80	7330B	2	NTN						
320,000	65,000	25,70	7330BG	2	NTN						
320,000	65,000	25,60	7330BGM	2	SNR						
320,000	130,000	51,20	7330BDB	2	NTN						
320,000	130,000	50,30	7330DB	2	NTN						
152,400	171,450	12,700	0,37	KRJ060LL	1	NTN					
	203,200	50,800	3,66	SF3030DB	2	NTN					
159,000	191,000	16,400	0,60	SF3254	2	NTN					
160,000	200,000	20,000	1,21	6832	1	NTN					
	200,000	20,000	1,18	6832LLU	1	NTN					
	200,000	20,000	1,19	6832ZZ	1	NTN					
	200,000	20,000	1,42	7832	2	NTN					

								Brands	
d	D	B	Kg	Reference					
160,000	200,000	20,000	0,77	SF3227	2	NTN			
	200,000	20,000	1,09	SF3240	2	NTN			
	200,000	31,000	2,05	51132	34	NTN-SNR			
	210,000	24,000	1,73	SF3242	2	NTN			
	215,000	28,000	2,74	SF3208	2	NTN			
	215,000	56,000	5,71	DE3207	5	NTN			
	220,000	28,000	2,61	6932	1	NTN			
	220,000	28,000	2,72	6932LLU	1	NTN			
	220,000	28,000	2,61	6932Z	1	NTN			
	220,000	28,000	2,61	6932ZZ	1	NTN			
	220,000	28,000	3,13	7932	2	NTN			
	220,000	28,000	2,80	7932CBG	2	NTN			
	225,000	51,000	6,15	51232	34	NTN			
	229,500	33,000	4,35	SC3209	1	NTN			
	229,500	33,000	4,52	SF3209	2	NTN			
	229,500	33,000	4,52	SF3214	2	NTN			
	229,500	36,000	4,72	SC3207	1	NTN			
	230,000	33,000	5,36	SC3210	1	NTN			
	230,000	33,000	4,15	SF3210	2	NTN			
	230,000	66,000	8,57	SF3210DF	2	NTN			
	240,000	25,000	3,73	16032	1	NTN-SNR			
	240,000	38,000	5,19	6032	1	NTN			
	240,000	38,000	5,35	6032EE	1	SNR			
	240,000	38,000	5,26	6032LLU	1	NTN			
	240,000	38,000	6,10	6032M	1	SNR			
	240,000	38,000	5,20	6032Z	1	NTN			
	240,000	38,000	5,24	6032ZZ	1	NTN			
	240,000	38,000	5,66	7032	2	NTN			
	240,000	38,000	5,96	7032B	2	NTN			
	240,000	38,000	5,65	7032C	2	NTN			
	240,000	38,000	5,96	7032CG	2	NTN			
	240,000	76,000	11,30	7032CDB	2	NTN			
	240,000	76,000	11,30	7032CDF	2	NTN			
	240,000	76,000	10,15	7032DB	2	NTN			
	240,000	76,000	12,00	DE3201	5	NTN			
	240,000	80,000	10,42	742032	35	NTN			
	240,000	114,000	17,88	7032BDBT	2	NTN			
	240,000	152,000	23,84	7032CDTBT	2	NTN			
	240,000	152,000	23,84	7032DTBT	2	NTN			
	270,000	87,000	19,90	51332	34	NTN			
	290,000	48,000	11,70	6232	1	NTN			
	290,000	48,000	14,45	6232M	1	SNR			
	290,000	48,000	12,74	6232Z	1	NTN			
	290,000	48,000	12,70	6232ZZ	1	NTN			
	290,000	48,000	13,70	7232	2	NTN			
290,000	48,000	14,10	7232B	2	NTN				
290,000	48,000	14,10	7232BG	2	NTN				
290,000	48,000	14,09	7232BGM	2	SNR				
290,000	48,000	13,74	7232C	2	NTN				
320,000	130,000	49,00	51432	34	NTN				
340,000	68,000	26,00	6332	1	NTN				
340,000	68,000	31,50	6332M	1	SNR				
340,000	68,000	29,80	7332	2	NTN				
340,000	68,000	30,40	7332B	2	NTN				
340,000	68,000	30,40	7332BG	2	NTN				
340,000	68,000	30,30	7332BGM	2	SNR				
165,000	210,000	24,000	1,52	SF3313	2	NTN			
165,100	177,800	6,350	0,14	KXA065	3	NTN			
	184,150	12,700	0,38	KRJ065LL	1	NTN			
	184,150	12,700	0,38	KXJ065LL	3	NTN			

								Brands	
d	D	B	Kg	Reference					
168,000	205,000	20,000	1,01	SF3421	2	NTN			
170,000	215,000	22,000	1,63	6834	1	NTN			
	215,000	22,000	1,19	6834ZZ	1	NTN			
	215,000	22,000	1,88	7834	2	NTN			
	215,000	34,000	2,78	51134	34	NTN			
	230,000	28,000	2,74	6934	1	NTN			
	230,000	28,000	2,74	6934Z	1	NTN			
	230,000	28,000	2,90	6934ZZ	1	NTN			
	230,000	28,000	3,29	7934	2	NTN			
	230,000	56,000	6,49	7934CDB	2	NTN			
	230,000	56,000	6,70	7934DF	2	NTN			
	230,000	112,000	13,00	7934CDTBT	2	NTN			
	240,000	55,000	7,48	51234	34	NTN			
	260,000	28,000	4,93	16034	1	NTN-SNR			
	260,000	42,000	6,76	6034	1	NTN			
	260,000	42,000	8,20	6034M	1	SNR			
	260,000	42,000	6,96	6034Z	1	NTN			
	260,000	42,000	7,06	6034ZZ	1	NTN			
	260,000	42,000	7,96	7034	2	NTN			
	260,000	42,000	8,02	7034B	2	NTN			
	260,000	42,000	7,62	7034C	2	NTN			
	260,000	81,000	13,00	SF3408DB	2	NTN			
	260,000	84,000	15,24	7034CDB	2	NTN			
	260,000	84,000	15,00	7034DB	2	NTN			
	260,000	84,000	16,10	DE3402	5	NTN			
	260,000	126,000	23,88	7034CDBT	2	NTN			
	260,000	168,000	31,84	7034BDBTT	2	NTN			
	280,000	87,000	20,80	51334	34	NTN			
	310,000	52,000	15,90	6234	1	NTN			
	310,000	52,000	17,70	6234M	1	SNR			
	310,000	52,000	15,80	6234Z	1	NTN			
	310,000	52,000	14,50	6234ZZ	1	NTN			
	310,000	52,000	17,00	7234	2	NTN			
310,000	52,000	18,60	7234B	2	NTN				
310,000	52,000	17,40	7234BG	2	NTN				
310,000	52,000	17,75	7234BGM	2	SNR				
310,000	156,000	55,80	7234BDFT	2	NTN				
340,000	135,000	55,80	51434	34	NTN				
360,000	72,000	30,80	6334	1	NTN				
360,000	72,000	30,30	6334K	1	NTN				
360,000	72,000	35,80	7334	2	NTN				
360,000	72,000	35,89	7334B	2	NTN				
360,000	72,000	36,00	7334BG	2	NTN				
360,000	72,000	35,80	7334BGM	2	SNR				
360,000	144,000	71,60	7334DB	2	NTN				
175,000	280,000	92,000	21,70	DE3501	5	NTN			
	280,000	92,000	21,70	DE3502	5	NTN			
176,000	216,000	21,000	1,23	SF3506	2	NTN			
177,800	196,850	12,700	0,42	KRJ070LL	1	NTN			
180,000	225,000	22,000	1,96	6836	1	NTN			
	225,000	22,000	1,96	6836AZZ	1	NTN			
	225,000	22,000	1,98	7836	2	NTN			
	225,000	22,000	1,18	SF3607V	2	NTN			
	225,000	34,000	2,72	51136	34	NTN			
	250,000	33,000	4,13	6936	1	NTN			
250,000	33,000	4,80	6936AZ	1	NTN				
250,000	33,000	4,81	6936AZZ	1	NTN				

										Brands		
d	D	B	Kg	Reference								
180,000	250,000	33,000	4,87	7936	2	NTN						
	250,000	56,000	8,07	51236	34	NTN						
	250,000	63,000	7,89	SF3624DB	2	NTN						
	250,000	66,000	9,74	7936DB	2	NTN						
	250,000	66,000	9,83	DE3606	5	NTN						
	250,000	66,000	8,27	SF3635DB	2	NTN						
	250,000	70,000	10,40	DE3609	5	NTN						
	259,500	33,000	5,95	6936/2595	1	NTN						
	259,500	33,000	5,70	SF3618	2	NTN						
	259,500	33,000	5,80	SF3629	2	NTN						
	259,500	33,000	5,75	SF3639	2	NTN						
	259,500	33,000	5,65	SF3641	2	NTN						
	259,500	66,000	10,40	DE3601	5	NTN						
	259,500	66,000	10,70	DE3603	5	NTN						
	259,500	66,000	10,70	DE3608	5	NTN						
	259,500	66,000	10,40	DE3610	5	NTN						
	259,500	66,000	10,40	DE3612	5	NTN						
	259,500	66,000	10,70	DE3615	5	NTN						
	259,500	66,000	11,40	SF3618DB	2	NTN						
	259,500	66,000	11,60	SF3629DF	2	NTN						
	259,500	66,000	11,41	SF3639DB	2	NTN						
	259,500	66,000	11,50	SF3644DB	2	NTN						
	265,000	33,000	6,08	SC3605	1	NTN						
	265,000	66,000	11,50	SF3654DB	2	NTN						
	280,000	46,000	8,80	6036	1	NTN						
	280,000	46,000	9,23	6036LLU	1	NTN						
	280,000	46,000	10,60	6036M	1	SNR						
	280,000	46,000	9,10	6036ZZ	1	NTN						
	280,000	46,000	10,40	7036	2	NTN						
	280,000	46,000	10,50	7036B	2	NTN						
	280,000	46,000	10,40	7036G	2	NTN						
	280,000	92,000	20,80	7036DB	2	NTN						
	280,000	92,000	20,80	7036DF	2	NTN						
	280,000	92,000	20,90	DE3605	5	NTN						
	280,000	100,000	18,50	742036	35	NTN						
	280,000	138,000	31,20	7036DBDT	2	NTN						
	300,000	95,000	25,80	51336	34	NTN						
	320,000	52,000	15,10	6236	1	NTN						
	320,000	52,000	16,00	6236K	1	NTN						
	320,000	52,000	18,30	6236M	1	SNR						
	320,000	52,000	15,80	6236Z	1	NTN						
	320,000	52,000	15,90	6236ZZ	1	NTN						
	320,000	52,000	17,70	7236	2	NTN						
	320,000	52,000	17,80	7236B	2	NTN						
	320,000	52,000	17,80	7236BG	2	NTN						
	320,000	104,000	35,40	7236DB	2	NTN						
	380,000	75,000	37,00	6336	1	NTN						
	380,000	75,000	40,90	7336	2	NTN						
	380,000	75,000	41,80	7336B	2	NTN						
	180,300	280,000	46,000	9,10	6036/1803	1	NTN					
	182,000	214,000	17,000	0,86	SF3662	2	NTN					
	185,000	269,500	38,000	6,20	SC3705	1	NTN					
	188,000	250,000	30,000	3,19	SF3832	2	NTN					
	190,000	236,000	21,000	1,80	SF3833	2	NTN					
		236,000	21,000	1,49	SF3835	2	NTN					
240,000		24,000	2,62	6838	1	NTN						
240,000		24,000	2,55	7838	2	NTN						

										Brands		
d	D	B	Kg	Reference								
190,000	240,000	37,000	3,52	51138	34	NTN						
	255,000	33,000	4,16	SF3806	2	NTN						
	255,000	66,000	8,74	SF3806DB	2	NTN						
	259,500	33,000	5,10	SF3816	2	NTN						
	259,500	70,000	11,00	SF3819DB	2	NTN						
	260,000	33,000	4,98	6938	1	NTN						
	260,000	33,000	5,10	7938	2	NTN						
	260,000	66,000	10,20	7938BDB	2	NTN						
	269,500	33,000	5,87	SC3805	1	NTN						
	269,500	33,000	5,95	SF3802	2	NTN						
	269,500	33,000	6,05	SF3807	2	NTN						
	269,500	66,000	11,90	DE3801	5	NTN						
	269,500	66,000	11,90	DE3807	5	NTN						
	269,500	66,000	12,00	SF3836DB	2	NTN						
	270,000	62,000	10,80	51238	34	NTN						
	290,000	31,000	6,77	16038	1	NTN-SNR						
	290,000	46,000	9,18	6038	1	NTN						
	290,000	46,000	11,03	6038M	1	SNR						
	290,000	46,000	9,47	6038Z	1	NTN						
	290,000	46,000	9,56	6038ZZ	1	NTN						
	290,000	46,000	10,80	7038	2	NTN						
	290,000	46,000	10,90	7038B	2	NTN						
	290,000	46,000	10,40	7038C	2	NTN						
	290,000	46,000	21,60	7038DB	2	NTN						
	320,000	105,000	33,60	51338	34	NTN						
	340,000	55,000	19,20	6238	1	NTN						
	340,000	55,000	22,20	6238M	1	SNR						
	340,000	55,000	19,14	6238Z	1	NTN						
	340,000	55,000	19,17	6238ZZ	1	NTN						
	340,000	55,000	18,20	7238	2	NTN						
	340,000	55,000	22,10	7238B	2	NTN						
	340,000	55,000	22,72	7238BG	2	NTN						
	340,000	55,000	21,30	7238C	2	NTN						
	340,000	55,000	24,40	QJ238	3	NTN						
	340,000	55,000	24,400	QJ238C3S30	3	NTN						
	340,000	55,000	24,400	QJ238WC3S30	3	NTN						
	340,000	110,000	44,00	7238DF	2	NTN						
	400,000	78,000	41,00	6338	1	NTN						
	400,000	78,000	47,00	7338	2	NTN						
	400,000	78,000	47,00	7338B	2	NTN						
	400,000	78,000	47,00	7338BG	2	NTN						
	190,500	209,550	12,700	0,44	KRJ075LL	1	NTN					
	195,000	270,000	35,000	6,04	SC3904	1	NTN					
		270,000	35,000	6,20	SF3901	2	NTN					
	200,000	250,000	24,000	2,69	6840	1	NTN					
		250,000	24,000	2,52	6840ALLU	1	NTN					
		250,000	24,000	2,70	7840	2	NTN					
		250,000	24,000	1,49	SF4021	2	NTN					
		250,000	37,000	3,74	51140	34	NTN					
		260,000	30,000	3,23	SF4019	2	NTN					
		279,500	38,000	7,11	6940/2795	1	NTN					
		279,500	38,000	7,15	SF4006	2	NTN					
		279,500	76,000	13,90	7940B/279.5DB	2	NTN					
		279,500	76,000	14,30	DE4004	5	NTN					
		279,500	76,000	14,30	DE4008	5	NTN					
279,500		76,000	14,30	SF4044DB	2	NTN						
280,000	38,000	6,07	6940	1	NTN							
280,000	38,000	7,15	7940	2	NTN							
280,000	62,000	11,40	51240	34	NTN							

d	D	B	Kg	Reference	Brands	
200,000	280,000	72,000	14,50	SF4030DB	2 NTN	
	280,000	76,000	14,00	7940BDF	2 NTN	
	280,000	76,000	14,00	7940DB	2 NTN	
	289,500	38,000	8,24	6940/2895	1 NTN	
	289,500	38,000	8,25	SF4017	2 NTN	
	289,500	76,000	16,40	DE4002	5 NTN	
	289,500	76,000	16,40	DE4009	5 NTN	
	289,500	76,000	16,50	DE4010	5 NTN	
	289,500	76,000	16,40	DE4012	5 NTN	
	289,500	76,000	16,40	DE4019	5 NTN	
	289,500	76,000	13,90	SF4017DF	2 NTN	
	310,000	34,000	9,03	16040	1 NTN-SNR	
	310,000	51,000	11,90	6040	1 NTN	
	310,000	51,000	14,18	6040M	1 SNR	
	310,000	51,000	12,10	6040Z	1 NTN	
	310,000	51,000	12,30	6040ZZ	1 NTN	
	310,000	51,000	13,50	7040	2 NTN	
	310,000	51,000	13,86	7040B	2 NTN	
	310,000	102,000	27,00	7040DB	2 NTN	
	310,000	102,000	28,30	DE4007	5 NTN	
	340,000	110,000	40,20	51340	34 NTN	
	360,000	58,000	21,60	6240	1 NTN	
	360,000	58,000	26,50	6240M	1 SNR	
	360,000	58,000	23,40	6240Z	1 NTN	
	360,000	58,000	23,50	6240ZZ	1 NTN	
	360,000	58,000	26,31	7240B	2 NTN	
	360,000	58,000	27,500	TM-QJ240AC3S30	3 NTN	
	360,000	58,000	27,500	TM-QJ240AWC3S30	3 NTN	
	360,000	116,000	51,30	7240DB	2 NTN	
	360,000	116,000	50,60	7240DF	2 NTN	
	360,000	116,000	50,60	7240DT	2 NTN	
	420,000	80,000	47,50	6340	1 NTN	
	420,000	80,000	54,20	7340B	2 NTN	
	202,000	360,000	58,000	25,30	7240	2 NTN
	203,200	228,600	25,400	1,30	KYD080DB	2 NTN
		330,200	88,900	14,70	SF4104	2 NTN
	204,000	420,000	80,000	53,10	7340	2 NTN
	208,000	260,000	23,000	2,27	SF4230	2 NTN
	210,000	262,000	24,000	2,33	SF4229	2 NTN
280,000		35,000	4,56	SF4224	2 NTN	
300,000		40,000	9,05	SF4211	2 NTN	
214,000	264,000	25,500	2,39	SF4308	2 NTN	
	264,000	25,500	2,44	SF4309	2 NTN	
220,000	270,000	24,000	3,00	6844	1 NTN	
	270,000	24,000	2,91	7844	2 NTN	
	270,000	37,000	4,00	51144	34 NTN	
	276,000	26,000	2,79	SF4469	2 NTN	
	295,000	32,000	4,80	SF4460	2 NTN	
	295,000	32,000	4,80	SF4466	2 NTN	
	295,000	33,000	4,70	SF4454	2 NTN	
	295,000	33,000	4,80	SF4467	2 NTN	
	300,000	38,000	7,69	6944	1 NTN	
	300,000	38,000	7,70	6944BZZ	1 NTN	
	300,000	38,000	7,69	6944LLU	1 NTN	
	300,000	38,000	7,74	7944	2 NTN	

d	D	B	Kg	Reference	Brands	
220,000	300,000	38,000	7,25	SF4407	2 NTN	
	300,000	63,000	12,50	51244	34 NTN	
	300,000	76,000	19,00	7944DB	2 NTN	
	300,000	76,000	15,48	F-7944DB	1 NTN	
	300,000	76,000	15,10	SF4403DB	2 NTN	
	300,000	76,000	14,50	SF4407DB	2 NTN	
	309,500	38,000	7,50	SC4401	1 NTN	
	309,500	38,000	8,90	SF4421	2 NTN	
	309,500	38,000	8,90	SF4433	2 NTN	
	309,500	76,000	17,80	DE4403	5 NTN	
	309,500	76,000	17,80	DE4404	5 NTN	
	309,500	76,000	17,80	DE4408	5 NTN	
	309,500	76,000	8,95	SF4421DB	2 NTN	
	309,500	76,000	17,50	SF4470DB	2 NTN	
	319,500	46,000	12,32	SC4405	1 NTN	
	319,500	46,000	12,20	SF4438	2 NTN	
	319,500	92,000	24,40	DE4406	5 NTN	
	319,500	92,000	24,40	DE4409	5 NTN	
	319,500	92,000	24,50	SF4409DB	2 NTN	
	340,000	37,000	11,30	16044	1 NTN	
	340,000	56,000	15,70	6044	1 NTN	
	340,000	56,000	16,22	6044Z	1 NTN	
	340,000	56,000	16,40	6044ZZ	1 NTN	
	340,000	56,000	18,20	7044	2 NTN	
	340,000	56,000	18,40	7044B	2 NTN	
	340,000	112,000	36,20	7044BDF	2 NTN	
	340,000	112,000	36,40	7044DF	2 NTN	
	400,000	65,000	33,00	6244	1 NTN	
	400,000	65,000	37,10	7244	2 NTN	
	400,000	65,000	25,46	7244B	2 NTN	
	460,000	88,000	60,80	6344	1 NTN	
	460,000	88,000	72,40	7344	2 NTN	
	228,600	244,475	7,938	0,25	KXB090	3 NTN
		247,650	12,700	0,47	KRJ090LL	1 NTN
		279,400	50,800	3,24	KYG090DF	2 NTN
	230,000	290,000	26,000	3,24	SF4649	2 NTN
		290,000	26,000	3,24	SF4651	2 NTN
		300,000	35,000	5,32	SF4615	2 NTN
		300,000	35,000	4,56	SF4639	2 NTN
		329,500	40,000	11,00	SC4605	1 NTN
		329,500	40,000	9,27	SC4608	1 NTN
		329,500	40,000	11,00	SF4614	2 NTN
		329,500	80,000	22,00	DE4602	5 NTN
		329,500	80,000	22,00	DE4603	5 NTN
		329,500	80,000	22,00	DE4605	5 NTN
		339,500	45,000	11,70	SC4609	1 NTN
		240,000	300,000	28,000	4,51	6848
	300,000		28,000	3,78	6848C	1 NTN
	300,000		28,000	4,13	6848LLB	1 NTN
	300,000		28,000	4,49	7848	2 NTN
	300,000		28,000	4,31	SF4810	2 NTN
	300,000		45,000	6,48	51148	34 NTN
300,000	56,000		8,56	7848DB	2 NTN	
310,000	33,000		4,90	SF4815	2 NTN	
310,000	33,000		4,90	SF4831	2 NTN	
310,000	33,000		4,81	SF4840	2 NTN	
320,000	38,000		8,30	6948	1 NTN	
320,000	38,000		8,58	6948BLLB	1 NTN	
320,000	38,000		8,58	6948BZZ	1 NTN	



d	D	B	Kg	Reference					
240,000	320,000	38,000	8,34	7948	2	NTN			
	320,000	38,000	6,96	SF4860	2	NTN			
	329,500	40,000	10,20	SC4806	1	NTN			
	329,500	40,000	10,10	SF4814	2	NTN			
	329,500	40,000	10,10	SF4818	2	NTN			
	329,500	40,000	10,00	SF4839	2	NTN			
	329,500	80,000	10,20	SF4818DB	2	NTN			
	340,000	40,000	11,50	SF4802	2	NTN			
	340,000	78,000	21,60	51248	34	NTN			
	359,500	112,000	39,70	DE4803	5	NTN			
	360,000	37,000	14,10	16048	1	NTN			
	360,000	56,000	16,80	6048	1	NTN			
	360,000	56,000	17,39	6048Z	1	NTN			
	360,000	56,000	17,40	6048ZZ	1	NTN			
	360,000	56,000	19,50	7048	2	NTN			
	360,000	56,000	19,80	7048B	2	NTN			
	360,000	112,000	33,60	6048D2	1	NTN			
	440,000	72,000	51,70	6248	1	NTN			
	440,000	72,000	49,80	7248	2	NTN			
	500,000	95,000	76,10	6348	1	NTN			
	500,000	95,000	92,20	7348	2	NTN			
	500,000	95,000	93,00	7348BG	2	NTN			
	243,000	312,000	33,000	5,00	SF4910	2	NTN		
246,000	308,000	32,000	3,97	SF4903	2	NTN			
250,000	320,000	35,000	5,21	SF5015	2	NTN			
	340,000	38,000	9,55	SF5005	2	NTN			
	340,000	76,000	18,40	DE5004	5	NTN			
	340,000	76,000	19,10	SF5005DB	2	NTN			
	349,500	46,000	13,40	SC5003	1	NTN			
	349,500	46,000	13,60	SF5004	2	NTN			
	349,500	92,000	25,30	SF5008DB	2	NTN			
	254,000	266,700	6,350	0,20	KRA100	1	NTN		
	279,400	25,400	1,70	KYD100DB	2	NTN			
	292,100	19,050	1,65	KXF100	3	NTN			
255,000	310,000	27,500	3,36	SF5110	2	NTN			
	310,000	27,500	3,40	SF5111	2	NTN			
260,000	320,000	28,000	5,00	6852	1	NTN			
	320,000	28,000	4,83	7852	2	NTN			
	320,000	45,000	6,91	51152	34	NTN			
	330,000	35,000	5,16	SF5245	2	NTN			
	340,000	38,000	7,79	SF5220	2	NTN			
	340,000	38,000	7,02	SF5234	2	NTN			
	340,000	38,000	6,93	SF5246	2	NTN			
	360,000	46,000	13,90	6952	1	NTN			
	360,000	46,000	14,00	7952	2	NTN			
	360,000	79,000	23,40	51252	34	NTN			
	360,000	92,000	27,80	6952D2	1	NTN			
	360,000	92,000	28,00	7952DB	2	NTN			
	360,000	92,000	28,00	7952DF	2	NTN			
	369,500	46,000	16,20	6952/3695	1	NTN			
	369,500	46,000	16,10	SF5206	2	NTN			
	369,500	46,000	15,70	SF5210	2	NTN			
	369,500	46,000	15,70	SF5224	2	NTN			
	369,500	46,000	15,70	SF5225	2	NTN			
	369,500	92,000	31,30	DE5211	5	NTN			
	369,500	92,000	30,90	DE5212	5	NTN			

d	D	B	Kg	Reference						
260,000	369,500	92,000	31,30	DE5213	5	NTN				
	369,500	92,000	26,40	SF5210DF	2	NTN				
	379,500	56,000	17,80	SC5206	1	NTN				
	379,500	56,000	19,10	SF5218	2	NTN				
	379,500	112,000	0,000	SF5218DF	2	NTN				
	400,000	44,000	18,50	16052	1	NTN				
	400,000	65,000	25,00	6052	1	NTN				
	400,000	65,000	28,70	7052	2	NTN				
	400,000	65,000	29,00	7052B	2	NTN				
	480,000	80,000	65,70	6252	1	NTN				
	480,000	80,000	66,00	7252	2	NTN				
	480,000	80,000	45,72	7252B	2	NTN				
	540,000	102,000	116,00	6352	1	NTN				
	540,000	102,000	115,00	7352	2	NTN				
	270,000	350,000	40,000	8,82	SF5405	2	NTN			
	279,400	304,800	12,700	0,89	KXD110	3	NTN			
	280,000	350,000	33,000	6,10	6856	1	NTN			
		350,000	33,000	7,17	7856	2	NTN			
		350,000	53,000	11,10	51156	34	NTN			
		360,000	38,000	9,47	SC5605	1	NTN			
		380,000	46,000	14,40	6956	1	NTN			
		380,000	46,000	12,60	6956BLB	1	NTN			
		380,000	46,000	12,60	6956LLU	1	NTN			
380,000		46,000	14,80	7956	2	NTN				
380,000		46,000	14,16	F-6956F2	1	NTN				
380,000		80,000	26,10	51256	34	NTN				
380,000		92,000	35,00	7956DB	2	NTN				
380,000		92,000	30,00	SF5615DB	2	NTN				
389,500		46,000	14,00	6956/3895	1	NTN				
389,500		46,000	16,00	SF5606	2	NTN				
389,500		46,000	16,00	SF5608	2	NTN				
389,500		92,000	33,40	DE5605	5	NTN				
389,500		92,000	28,10	SF5606DB	2	NTN				
389,500		92,000	28,10	SF5608DF	2	NTN				
389,500		92,000	28,10	SF5626DB	2	NTN				
400,000		48,000	15,30	SF5627	2	NTN				
420,000		44,000	23,90	16056	1	NTN				
420,000		65,000	31,90	6056	1	NTN				
420,000		65,000	30,70	7056	2	NTN				
420,000	65,000	30,90	7056B	2	NTN					
420,000	130,000	61,40	7056CDB	2	NTN					
420,000	130,000	61,40	7056DB	2	NTN					
500,000	80,000	70,90	6256	1	NTN					
500,000	80,000	69,70	7256	2	NTN					
500,000	160,000	114,00	7256DB	2	NTN					
580,000	108,000	142,00	6356	1	NTN					
580,000	108,000	140,00	7356	2	NTN					
281,000	354,000	37,000	6,70	SF5622	2	NTN				
285,000	380,000	46,000	14,70	SF5702	2	NTN				
290,000	409,500	112,000	22,90	SF5813DB	2	NTN				
	419,500	60,000	26,80	SC5803	1	NTN				
	419,500	60,000	26,90	SF5803	2	NTN				
297,000	355,000	27,000	1,00	SF5910	2	NTN				
300,000	368,000	34,000	6,17	SF6021	2	NTN				

										Brands		
d	D	B	Kg	Reference								
300,000	372,000	36,000	6,90	SF6015	2	NTN						
	380,000	38,000	10,50	6860	1	NTN						
	380,000	38,000	10,10	7860	2	NTN						
	380,000	62,000	17,50	51160	34	NTN						
	419,500	56,000	20,00	6960/4195	1	NTN						
	419,500	112,000	45,70	7960/419.5DF	2	NTN						
	419,500	112,000	46,33	SF6022DF	2	NTN						
	420,000	56,000	23,50	6960	1	NTN						
	420,000	56,000	23,70	7960	2	NTN						
	420,000	95,000	38,70	51260	34	NTN						
	429,500	112,000	52,40	DE6001	5	NTN						
	460,000	50,000	32,50	16060	1	NTN						
	460,000	74,000	43,80	6060	1	NTN						
	460,000	74,000	43,40	7060	2	NTN						
	460,000	74,000	43,70	7060B	2	NTN						
	460,000	148,000	73,50	7060CDB	2	NTN						
	460,000	148,000	86,80	7060DB	2	NTN						
	540,000	85,000	88,90	6260	1	NTN						
	540,000	85,000	87,20	7260	2	NTN						
	304,800	323,850	9,525	0,50	KXC120	3	NTN					
342,900		19,050	2,22	KYF120	2	NTN						
310,000	429,500	60,000	25,80	SC6201	1	NTN						
	429,500	60,000	26,70	SF6203	2	NTN						
	429,500	120,000	25,30	SF6203DB	2	NTN						
	450,000	50,000	25,90	SC6203	1	NTN						
320,000	383,000	30,000	5,41	SF6419	2	NTN						
	395,000	35,000	7,60	SF6420	2	NTN						
	400,000	38,000	10,84	6864	1	NTN						
	400,000	38,000	10,70	7864	2	NTN						
	400,000	63,000	17,40	51164	34	NTN						
	440,000	56,000	25,34	6964	1	NTN						
	440,000	56,000	24,70	7964	2	NTN						
	440,000	72,000	30,00	72964	1	NTN						
	440,000	95,000	42,30	51264	34	NTN						
	449,500	56,000	27,60	SC6406	1	NTN						
	470,000	70,000	40,40	SC6403	1	NTN						
	480,000	50,000	34,20	16064	1	NTN						
	480,000	74,000	46,24	6064	1	NTN						
	480,000	74,000	45,70	7064	2	NTN						
	580,000	92,000	110,00	6264	1	NTN						
	580,000	92,000	109,00	7264	2	NTN						
	328,000	404,000	38,000	8,26	SF6605	2	NTN					
340,000	420,000	38,000	11,50	6868	1	NTN						
	420,000	38,000	11,30	7868	2	NTN						
	420,000	64,000	18,60	51168	34	NTN						
	460,000	56,000	26,20	6968	1	NTN						
	460,000	56,000	26,00	7968	2	NTN						
	460,000	96,000	43,40	51268	34	NTN						
	460,000	112,000	51,27	7968BDB	2	NTN						
	479,500	65,000	36,70	SF6807	2	NTN						
	479,500	130,000	72,00	SF6807DF	2	NTN						
	479,500	130,000	72,00	SF6811DB	2	NTN						
	489,500	60,000	36,20	SC6802	1	NTN						
	489,500	65,000	40,00	SC6809	1	NTN						
	520,000	57,000	47,10	16068	1	NTN						
	520,000	82,000	61,80	6068	1	NTN						
	520,000	82,000	61,10	7068	2	NTN						

										Brands	
d	D	B	Kg	Reference							
340,000	620,000	92,000	129,00	6268	1	NTN					
	620,000	92,000	127,00	7268	2	NTN					
350,000	400,000	25,000	3,51	SF7008	2	NTN					
355,000	435,000	40,550	10,28	SF7113	2	NTN					
355,600	374,650	9,525	0,77	KXC140	3	NTN					
	406,400	25,400	4,09	KXG140	3	NTN					
	469,900	57,150	26,30	SC7101	1	NTN					
360,000	440,000	38,000	17,00	6872	1	NTN					
	440,000	38,000	11,90	7872	2	NTN					
	440,000	65,000	19,98	51172	34	NTN					
	479,500	56,000	27,70	6972/4795	1	NTN					
	480,000	56,000	27,70	6972	1	NTN					
	480,000	56,000	27,30	7972	2	NTN					
	500,000	110,000	63,90	51272	34	NTN					
	509,500	70,000	45,00	SC7205	1	NTN					
	509,500	70,000	45,00	SF7203	2	NTN					
	540,000	57,000	49,30	16072	1	NTN					
	540,000	82,000	65,80	6072	1	NTN					
	540,000	82,000	63,40	7072	2	NTN					
	540,000	164,000	131,00	DE7201	5	NTN					
	650,000	95,000	145,00	6272	1	NTN					
650,000	95,000	143,00	7272	2	NTN						
380,000	460,000	65,000	21,00	51176	34	NTN					
	480,000	46,000	19,70	6876	1	NTN					
	480,000	46,000	19,50	7876	2	NTN					
	519,500	65,000	39,80	6976/5195	1	NTN					
	519,500	65,000	41,30	SF7603	2	NTN					
	519,500	130,000	82,60	SF7603DB	2	NTN					
	520,000	65,000	39,80	6976	1	NTN					
	520,000	65,000	39,60	7976	2	NTN					
	520,000	130,000	79,20	7976DB	2	NTN					
	540,000	164,000	61,00	SF7601	2	NTN					
	560,000	57,000	50,10	16076	1	NTN					
	560,000	82,000	67,50	6076	1	NTN					
	560,000	82,000	66,30	7076	2	NTN					
	760,000	128,000	231,00	SC7606	1	NTN					
400,000	480,000	65,000	21,90	51180	34	NTN					
	500,000	46,000	20,50	6880	1	NTN					
	500,000	46,000	20,40	7880	2	NTN					
	540,000	65,000	42,10	6980	1	NTN					
	540,000	65,000	41,00	7980	2	NTN					
	598,000	90,000	82,00	SF8011	2	NTN					
	600,000	63,000	65,80	16080	1	NTN					
	600,000	90,000	87,60	6080	1	NTN					
	600,000	90,000	86,10	7080	2	NTN					
	600,000	90,000	87,60	F-6080	1	NTN					
	600,000	180,000	85,00	7080DB	2	NTN					
	720,000	130,000	226,00	SC8002	1	NTN					
720,000	130,000	240,00	SC8011	1	NTN						
402,000	600,000	90,000	83,00	SF8012	2	NTN					
406,400	444,500	19,050	2,50	KXF160	3	NTN					
420,000	500,000	65,000	22,94	51184	34	NTN					
	520,000	46,000	21,60	6884	1	NTN					

										Brands	
d	D	B	Kg	Reference							
420,000	520,000	46,000	21,10	7884	2	NTN					
	520,000	145,000	59,00	6884D2	1	NTN					
	560,000	65,000	43,40	6984	1	NTN					
	560,000	65,000	42,80	7984	2	NTN					
	620,000	90,000	91,10	6084	1	NTN					
	620,000	90,000	89,70	7084	2	NTN					
440,000	540,000	46,000	21,62	6888	1	NTN					
	540,000	46,000	22,00	7888	2	NTN					
	540,000	80,000	38,08	51188	34	NTN					
	599,000	80,000	65,00	SC8803	1	NTN					
	600,000	74,000	61,20	6988	1	NTN					
	600,000	74,000	59,30	7988	2	NTN					
	650,000	94,000	104,00	6088	1	NTN					
	650,000	94,000	103,00	7088	2	NTN					
450,000	629,000	80,000	76,00	SC9001	1	NTN					
	650,000	94,000	99,70	6088/450	1	NTN					
460,000	540,000	40,000	15,80	SF9211	2	NTN					
	560,000	80,000	41,60	51192	34	NTN					
	580,000	56,000	34,80	6892	1	NTN					
	580,000	56,000	33,50	7892	2	NTN					
	580,000	180,000	101,00	6892D2	1	NTN					
	620,000	74,000	62,20	6992	1	NTN					
	620,000	74,000	61,60	7992	2	NTN					
	620,000	130,000	106,00	51292	34	NTN					
	680,000	100,000	122,00	6092	1	NTN					
	680,000	100,000	119,00	7092	2	NTN					
470,000	570,000	50,000	25,70	SF9404	2	NTN					
480,000	600,000	56,000	35,10	6896	1	NTN					
	600,000	56,000	34,90	7896	2	NTN					
	650,000	78,000	73,00	6996	1	NTN					
	650,000	78,000	71,80	7996	2	NTN					
	700,000	100,000	126,00	6096	1	NTN					
	700,000	100,000	123,00	7096	2	NTN					
500,000	620,000	56,000	36,74	68/500	1	NTN					
	620,000	56,000	36,50	78/500	2	NTN					
	670,000	78,000	75,50	69/500	1	NTN					
	670,000	78,000	74,90	79/500	2	NTN					
	689,000	100,000	103,00	SC10006	1	NTN					
	720,000	100,000	112,00	60/500	1	NTN					
720,000	100,000	129,00	70/500	2	NTN						
508,000	558,800	25,400	6,68	KXG200	3	NTN					
520,000	719,000	100,000	118,00	SC10403	1	NTN					
	640,000	85,000	55,80	511/530	34	NTN					
	650,000	56,000	39,50	68/530	1	NTN					
	710,000	82,000	89,10	69/530	1	NTN					
	760,000	100,000	147,00	SC10605	1	NTN					
	780,000	112,000	178,00	60/530	1	NTN					
560,000	670,000	85,000	59,40	511/560	34	NTN					
	680,000	37,000	44,16	608/560	1	NTN					
	680,000	56,000	40,20	68/560	1	NTN					
	700,000	100,000	87,30	SF10013	2	NTN					
	748,000	85,000	105,00	SF11207	2	NTN					
	750,000	85,000	101,40	69/560	1	NTN					

										Brands	
d	D	B	Kg	Reference							
560,000	750,000	85,000	105,00	79/560	2	NTN					
	820,000	115,000	172,00	60/560	1	NTN					
562,000	748,000	85,000	105,00	SF11206	2	NTN					
570,000	790,000	115,000	166,00	SC11401	1	NTN					
600,000	730,000	60,000	51,70	68/600	1	NTN					
	800,000	90,000	122,00	69/600	1	NTN					
	870,000	118,000	228,00	60/600	1	NTN					
610,000	869,000	120,000	223,00	SC12203	1	NTN					
630,000	710,000	69,000	36,00	SC12601	1	NTN					
	750,000	95,000	82,50	511/630	34	NTN					
	780,000	69,000	71,60	68/630	1	NTN					
	780,000	69,000	72,20	78/630A	2	NTN					
	850,000	100,000	158,00	69/630	1	NTN					
	920,000	128,000	280,00	60/630	1	NTN					
650,000	919,000	118,000	246,00	SC13007	1	NTN					
670,000	800,000	78,000	71,10	591/670	34	NTN					
	820,000	69,000	75,10	68/670	1	NTN					
	820,000	69,000	76,30	78/670	2	NTN					
	820,000	69,000	76,30	78/670B	2	NTN					
	820,000	138,000	152,60	78/670BDB	2	NTN					
	900,000	103,000	178,20	69/670	1	NTN					
700,000	980,000	136,000	336,00	60/670	1	NTN					
700,000	900,000	74,000	112,00	SC14004	1	NTN					
	900,000	74,000	117,00	SF14001	2	NTN					
710,000	850,000	112,000	124,87	511/710	34	NTN					
	870,000	74,000	92,60	68/710	1	NTN					
	950,000	106,000	205,00	69/710	1	NTN					
	1 030,000	140,000	379,00	60/710	1	NTN					
750,000	920,000	78,000	107,00	68/750	1	NTN					
	1 000,000	112,000	238,00	69/750	1	NTN					
	1 070,000	140,000	403,00	SC15002	1	NTN					
	1 090,000	150,000	457,00	60/750	1	NTN					
800,000	980,000	82,000	127,00	68/800	1	NTN					
	1 060,000	115,000	272,00	69/800	1	NTN					
	1 150,000	155,000	522,00	60/800	1	NTN					
	1 150,000	155,000	444,00	SE16003	2	NTN					
820,000	1 060,000	110,000	247,00	SC16402	1	NTN					
	1 060,000	110,000	247,00	SC164028	1	NTN					
	1 160,000	160,000	524,00	SC16401	1	NTN					
850,000	1 030,000	82,000	135,00	68/850	1	NTN					
	1 080,000	82,000	195,00	68/850/1080	1	NTN					
	1 120,000	118,000	311,50	69/850	1	NTN					
	1 220,000	165,000	615,00	60/850	1	NTN					
889,000	939,800	25,400	9,90	KXG350	3	NTN					
900,000	1 030,000	44,000	68,00	SC18003	1	NTN					
	1 090,000	85,000	156,00	68/900	1	NTN					
	1 180,000	122,000	346,00	69/900	1	NTN					

								Brands	
d	D	B	Kg	Reference					
900,000	1 180,000	122,000	368,00	SE18002	2	NTN			
	1 280,000	170,000	685,00	60/900	1	NTN			
	1 280,000	220,000	972,00	SF18004DF	2	NTN			
	1 150,000	90,000	184,00	68/950	1	NTN			
	1 200,000	90,000	258,00	68/950/1200	1	NTN			
	1 250,000	132,000	424,00	69/950	1	NTN			
	1 360,000	180,000	855,00	60/950	1	NTN			
1 000,000	1 220,000	100,000	237,00	68/1000	1	NTN			
	1 320,000	140,000	506,00	69/1000	1	NTN			
	1 380,000	190,000	838,00	SC20003	1	NTN			
	1 380,000	190,000	876,00	SE20002	2	NTN			
	1 420,000	130,000	654,00	SF20001	2	NTN			
	1 420,000	185,000	945,00	60/1000	1	NTN			
	1 420,000	260,000	1 308,00	SF20001DF	2	NTN			
1 060,000	1 280,000	100,000	214,00	68/1060	1	NTN			
	1 280,000	100,000	249,50	78/1060	2	NTN			
	1 400,000	150,000	610,00	69/1060	1	NTN			
	1 500,000	195,000	1 126,00	60/1060	1	NTN			
	1 500,000	195,000	914,00	SE21201	2	NTN			
1 066,800	1 168,400	50,800	60,10	SE21302	2	NTN			
1 120,000	1 360,000	106,000	307,00	68/1120	1	NTN			
	1 460,000	150,000	640,00	69/1120	1	NTN			
	1 580,000	200,000	1 258,00	60/1120	1	NTN			
1 180,000	1 420,000	106,000	322,00	68/1180	1	NTN			
	1 540,000	160,000	762,00	69/1180	1	NTN			
1 250,000	1 500,000	112,000	376,00	68/1250	1	NTN			
	1 750,000	218,000	1 450,00	60/1250	1	NTN			
	1 750,000	218,000	1 730,00	SE25003	2	NTN			
1 320,000	1 600,000	122,000	495,00	68/1320	1	NTN			
1 500,000	2 000,000	218,000	1 950,00	SC30001	1	NTN			
	2 000,000	218,000	2 016,00	SE30002	2	NTN			



Classification by dimensions – Classement par dimensions
Klassifizierung nach Abmessungen – Classificazione per dimensione
Clasificación por dimensiones – Classificação por dimensões
Классификация по размерам – Klasyfikacja wg wymiarów



Cylindrical roller bearing



Zylinderrollenlager



Rodamientos de rodillos cilíndricos



Цилиндрические роликоподшипники



Roulements à rouleaux cylindriques



Cuscinetti a rulli cilindrici



Rolamentos de rolos cilíndricos



Łożyska walcowe



								Brands		
d	D	B	Kg	Reference						
15,000	35,000	11,000	0,05	NJ 202 EG15	18	SNR				
	35,000	11,000	0,05	NU 202 EG15	17	SNR				
17,000	40,000	12,000	0,07	N203	20	NTN				
	40,000	12,000	0,07	NF203	22	NTN				
	40,000	12,000	0,07	NJ203	18	NTN				
	40,000	12,000	0,07	NJ203E	18	NTN				
	40,000	12,000	0,07	NJ 203 EG15	18	SNR				
	40,000	12,000	0,07	NU203	17	NTN				
	40,000	12,000	0,07	NU 203 EG15	17	SNR				
	40,000	12,000	0,07	NUP203	19	NTN				
	40,000	16,000	0,05	NJ 2203 EG15	18	SNR				
	40,000	16,000	0,05	NU 2203 EG15	17	SNR				
	40,000	18,000	0,12	RNU0314ZZ	17	NTN				
	47,000	14,000	0,13	NJ 303 EG15	18	SNR				
	47,000	14,000	0,12	NU 303 EG15	17	SNR				
	20,000	26,955	37,000	0,07	RR0407	24	NTN			
47,000		14,000	0,11	N204	20	NTN				
47,000		14,000	0,11	N204E	20	NTN				
47,000		14,000	0,12	N 204 EG15	20	SNR				
47,000		14,000	0,11	NF204	22	NTN				
47,000		14,000	0,11	NF204E	22	NTN				
47,000		14,000	0,11	NJ204	18	NTN				
47,000		14,000	0,12	NJ204E	18	NTN				
47,000		14,000	0,11	NJ 204 EG15	18	SNR				
47,000		14,000	0,11	NU204	17	NTN				
47,000		14,000	0,12	NU204E	17	NTN				
47,000		14,000	0,11	NU 204 EG15	17	SNR				
47,000		14,000	0,12	NUP204	19	NTN				
47,000		14,000	0,12	NUP204E	19	NTN				
47,000		14,000	0,12	NUP 204 EG15	19	SNR				
47,000		18,000	0,14	NF2204	22	NTN				
47,000		18,000	0,15	NJ2204	18	NTN				
47,000		18,000	0,16	NJ2204E	18	NTN				
47,000		18,000	0,15	NJ 2204 EG15	18	SNR				
47,000		18,000	0,14	NU2204	17	NTN				
47,000		18,000	0,16	NU2204E	17	NTN				
47,000		18,000	0,14	NU 2204 EG15	17	SNR				
47,000		18,000	0,16	NUP2204E	19	NTN				
52,000		15,000	0,15	N304E	20	NTN				
52,000		15,000	0,15	N 304 EG15	20	SNR				
52,000		15,000	0,15	NF304	22	NTN				
52,000		15,000	0,15	NF304E	22	NTN				
52,000		15,000	0,15	NJ304	18	NTN				
52,000		15,000	0,18	NJ304E	18	NTN				
52,000		15,000	0,16	NJ 304 EG15	18	SNR				
52,000		15,000	0,15	NU304	17	NTN				
52,000		15,000	0,18	NU304E	17	NTN				
52,000		15,000	0,16	NU 304 EG15	17	SNR				
52,000		15,000	0,16	NUP304	19	NTN				
52,000		15,000	0,18	NUP304E	19	NTN				
52,000		21,000	0,22	NJ2304	18	NTN				
52,000		21,000	0,24	NJ2304E	18	NTN				
52,000		21,000	0,22	NJ 2304 EG15	18	SNR				
52,000		21,000	0,24	NU2304E	17	NTN				
52,000		21,000	0,21	NU 2304 EG15	17	SNR				
52,000		21,000	0,24	NUP2304E	19	NTN				
60,000		41,000	0,64	SLX20X60X41	26	NTN				
22,000		47,000	14,000	0,11	NUP204E/22	19	NTN			

								Brands	
d	D	B	Kg	Reference					
22,100	40,000	12,000	0,05	RNU 203 EG15	17	SNR			
22,900	40,000	12,000	0,05	RUS203	23	NTN			
24,000	52,000	16,000	0,16	RNJ0522V	18	NTN			
25,000	47,000	12,000	0,09	N1005	20	NTN			
	47,000	12,000	0,09	NJ1005	18	NTN			
	47,000	12,000	0,09	NU1005	17	NTN			
	47,000	12,000	0,09	NUP1005	19	NTN			
	52,000	15,000	0,13	N205	20	NTN			
	52,000	15,000	0,13	N205E	20	NTN			
	52,000	15,000	0,14	N 205 EG15	20	SNR			
	52,000	15,000	0,14	NF205	22	NTN			
	52,000	15,000	0,13	NF205E	22	NTN			
	52,000	15,000	0,14	NJ205	18	NTN			
	52,000	15,000	0,15	NJ205E	18	NTN			
	52,000	15,000	0,14	NJ 205 EG15	18	SNR			
	52,000	15,000	0,13	NU205	17	NTN			
	52,000	15,000	0,15	NU205E	17	NTN			
	52,000	15,000	0,14	NU 205 EG15	17	SNR			
	52,000	15,000	0,15	NUP205	19	NTN			
	52,000	15,000	0,15	NUP205E	19	NTN			
	52,000	15,000	0,14	NUP 205 EG15	19	SNR			
	52,000	15,000	0,10	RUS205	23	NTN			
	52,000	15,000	0,10	RUS205E	23	NTN			
	52,000	15,500	0,15	RNJ0537	18	NTN			
	52,000	18,000	0,17	NF2205	22	NTN			
	52,000	18,000	0,18	NFV2205	22	NTN			
	52,000	18,000	0,16	NH205	21	NTN			
	52,000	18,000	0,17	NJ2205	18	NTN			
	52,000	18,000	0,19	NJ2205E	18	NTN			
52,000	18,000	0,17	NJ 2205 EG15	18	SNR				
52,000	18,000	0,15	NU2205	17	NTN				
52,000	18,000	0,16	NU2205E	17	NTN				
52,000	18,000	0,17	NU 2205 EG15	17	SNR				
52,000	18,000	0,16	NUP2205	19	NTN				
52,000	18,000	0,19	NUP2205E	19	NTN				
52,000	18,000	0,18	NUP 2205 EG15	19	SNR				
52,000	20,600	0,21	R0534V	17	NTN				
52,000	20,600	0,19	RNUP0527	19	NTN				
62,000	17,000	0,23	N305	20	NTN				
62,000	17,000	0,23	N305E	20	NTN				
62,000	17,000	0,24	N 305 EG15	20	SNR				
62,000	17,000	0,24	NF305	22	NTN				
62,000	17,000	0,24	NF305E	22	NTN				
62,000	17,000	0,24	NJ305	18	NTN				
62,000	17,000	0,28	NJ305E	18	NTN				
62,000	17,000	0,25	NJ 305 EG15	18	SNR				
62,000	17,000	0,23	NU305	17	NTN				
62,000	17,000	0,28	NU305E	17	NTN				
62,000	17,000	0,24	NU 305 EG15	17	SNR				
62,000	17,000	0,24	NUP305	19	NTN				
62,000	17,000	0,28	NUP305E	19	NTN				
62,000	17,000	0,25	NUP 305 EG15	19	SNR				
62,000	17,000	0,18	RUS305	23	NTN				
62,000	24,000	0,34	NF2305E	22	NTN				
62,000	24,000	0,35	NJ2305	18	NTN				
62,000	24,000	0,39	NJ2305E	18	NTN				
62,000	24,000	0,35	NJ 2305 EG15	18	SNR				
62,000	24,000	0,34	NU2305	17	NTN				
62,000	24,000	0,39	NU2305E	17	NTN				

										Brands	
d	D	B	Kg	Reference							
25,000	62,000	24,000	0,34	NU 2305 EG15	17	SNR					
	62,000	24,000	0,39	NUP2305E	19	NTN					
	80,000	21,000	0,54	N405	20	NTN					
	80,000	21,000	0,57	NF405	22	NTN					
	80,000	21,000	0,55	NJ405	18	NTN					
	80,000	21,000	0,55	NU405	17	NTN					
	80,000	21,000	0,55	NUP405	19	NTN					
26,500	47,000	14,000	0,09	RNU 204 EG15	17	SNR					
27,000	47,000	14,000	0,08	RUS204	23	NTN					
	47,000	14,000	0,08	RUS204E	23	NTN					
28,000	62,000	25,000	0,35	RNU0627	17	NTN					
	74,000	42,000	0,70	SLX28X74X42	26	NTN					
28,500	52,000	15,000	0,11	RUS304	23	NTN					
	52,000	15,000	0,12	RUS304E	23	NTN					
28,737	57,000	18,000	0,20	R06A68V	17	NTN					
28,816	57,000	18,000	0,19	R06B09V	17	NTN					
30,000	55,000	13,000	0,13	N1006	20	NTN					
	55,000	13,000	0,13	NJ1006	18	NTN					
	55,000	13,000	0,13	NU1006	17	NTN					
	55,000	13,000	0,13	NUP1006	19	NTN					
	56,000	30,000	0,27	R06A72	17	NTN					
	57,000	27,000	0,25	R06A02	17	NTN					
	62,000	16,000	0,20	N206	20	NTN					
	62,000	16,000	0,20	N206E	20	NTN					
	62,000	16,000	0,27	N 206 EG15	20	SNR					
	62,000	16,000	0,21	NF206	22	NTN					
	62,000	16,000	0,21	NF206E	22	NTN					
	62,000	16,000	0,21	NJ206	18	NTN					
	62,000	16,000	0,23	NJ206E	18	NTN					
	62,000	16,000	0,21	NJ 206 EG15	18	SNR					
	62,000	16,000	0,22	NJ206EJC	18	NTN					
	62,000	16,000	0,22	NJK206	18	NTN					
	62,000	16,000	0,20	NU206	17	NTN					
	62,000	16,000	0,23	NU206E	17	NTN-SNR					
	62,000	16,000	0,21	NU 206 EG15	17	SNR					
	62,000	16,000	0,20	NU206EK	17	NTN					
	62,000	16,000	0,22	NUP206	19	NTN					
	62,000	16,000	0,23	NUP206E	19	NTN					
	62,000	16,000	0,22	NUP 206 EG15	19	SNR					
	62,000	20,000	0,28	NFV2206	22	NTN					
	62,000	20,000	0,27	NJ2206	18	NTN					
	62,000	20,000	0,30	NJ2206E	18	NTN					
	62,000	20,000	0,27	NJ 2206 EG15	18	SNR					
	62,000	20,000	0,26	NU2206	17	NTN					
	62,000	20,000	0,30	NU2206E	17	NTN					
	62,000	20,000	0,26	NU 2206 EG15	17	SNR					
	62,000	20,000	0,30	NU 2206 EM	17	SNR					
	62,000	20,000	0,27	NUP2206	19	NTN					
	62,000	20,000	0,30	NUP2206E	19	NTN					
	62,000	20,000	0,27	NUP 2206 EG15	19	SNR					
	62,000	24,000	0,32	2RNU0619	24	NTN					
	62,000	27,000	0,31	R0638	17	NTN					
	70,000	45,000	0,90	SLX30X85X45	26	NTN					
	72,000	19,000	0,35	N306	20	NTN					
	72,000	19,000	0,35	N306E	20	NTN					

										Brands	
d	D	B	Kg	Reference							
30,000	72,000	19,000	0,37	N 306 EG15	20	SNR					
	72,000	19,000	0,36	NF306	22	NTN					
	72,000	19,000	0,36	NF306E	22	NTN					
	72,000	19,000	0,36	NJ306	18	NTN					
	72,000	19,000	0,40	NJ306E	18	NTN					
	72,000	19,000	0,38	NJ 306 EG15	18	SNR					
	72,000	19,000	0,36	NU306	17	NTN					
	72,000	19,000	0,40	NU306E	17	NTN					
	72,000	19,000	0,37	NU 306 EG15	17	SNR					
	72,000	19,000	0,37	NUP306	19	NTN					
	72,000	19,000	0,40	NUP306E	19	NTN					
	72,000	19,000	0,37	NUP 306 EG15	19	SNR					
	72,000	23,500	0,45	RNJ0620	18	NTN					
	72,000	26,800	0,52	RNJ0626	18	NTN					
	72,000	27,000	0,55	NF2306	22	NTN					
	72,000	27,000	0,52	NJ2306	18	NTN					
	72,000	27,000	0,58	NJ2306E	18	NTN					
	72,000	27,000	0,54	NJ 2306 EG15	18	SNR					
	72,000	27,000	0,50	NU2306	17	NTN					
	72,000	27,000	0,58	NU2306E	17	NTN					
	72,000	27,000	0,53	NU 2306 EG15	17	SNR					
	72,000	27,000	0,58	NUP2306E	19	NTN					
	73,000	26,000	0,45	R0684	17	NTN					
	80,000	21,000	0,56	E-R0697V	17	NTN					
	80,000	23,000	0,61	R0694V	17	NTN					
	80,000	51,000	1,45	SLX30X80X51	26	NTN					
	82,000	20,000	0,61	RNUP0626	19	NTN					
	85,000	40,000	1,30	SLX30X85X40	26	NTN					
	88,860	17,000	1,41	R06B26V	17	NTN					
	88,860	17,000	1,41	R06B35V	17	NTN					
	90,000	23,000	0,73	N406	20	NTN					
	90,000	23,000	0,76	NF406	22	NTN					
90,000	23,000	0,76	NJ406	18	NTN						
90,000	23,000	0,75	NU406	17	NTN						
90,000	23,000	0,75	NUP406	19	NTN						
260,000	89,000	22,20	2R2057VLL	24	NTN						
31,500	52,000	15,000	0,10	RNU 205 EG15	17	SNR					
	52,000	18,000	0,14	RUS2205E	23	NTN					
32,000	65,000	28,000	0,36	E-R06A92	17	NTN					
	65,000	30,000	0,38	R0686	17	NTN					
	65,000	30,000	0,39	R06A79	17	NTN					
	68,000	30,000	0,47	R0608	17	NTN					
	68,000	30,000	0,47	R0688	17	NTN					
	68,000	30,000	0,47	R06A49	17	NTN					
	68,000	30,000	0,47	R06A65	17	NTN					
	68,000	30,000	0,54	R06B13	17	NTN					
	68,000	30,000	0,54	R06B32	17	NTN					
	73,500	38,000	0,74	R06A70	17	NTN					
	90,000	23,000	0,81	R0679V	17	NTN					
34,000	62,000	17,000	0,20	RUS305E	23	NTN					
	62,000	24,000	0,26	RUS2305E	23	NTN					
35,000	62,000	14,000	0,18	N1007	20	NTN					
	62,000	14,000	0,18	NJ1007	18	NTN					
	62,000	14,000	0,18	NU1007	17	NTN					
	62,000	14,000	0,18	NUP1007	19	NTN					
	67,000	52,000	0,72	R0781D2	17	NTN					
	68,000	30,000	0,44	R07A17	17	NTN					
	72,000	17,000	0,29	N207	20	NTN					

d	D	B	Kg	Reference			
35,000	72,000	17,000	0,29	N207E	20	NTN	
	72,000	17,000	0,30	N 207 EG15	20	SNR	
	72,000	17,000	0,30	NF207	22	NTN	
	72,000	17,000	0,49	NF207E	22	NTN	
	72,000	17,000	0,30	NJ207	18	NTN	
	72,000	17,000	0,33	NJ207E	18	NTN	
	72,000	17,000	0,30	NJ 207 EG15	18	SNR	
	72,000	17,000	0,30	NU207	17	NTN	
	72,000	17,000	0,33	NU207E	17	NTN-SNR	
	72,000	17,000	0,30	NU 207 EG15	17	SNR	
	72,000	17,000	0,30	NU207EK	17	NTN	
	72,000	17,000	0,34	NU 207 EM	17	SNR	
	72,000	17,000	0,30	NU207K	17	NTN	
	72,000	17,000	0,31	NUP207	19	NTN	
	72,000	17,000	0,33	NUP207E	19	NTN	
	72,000	17,000	0,30	NUP 207 EG15	19	SNR	
	72,000	19,000	0,36	RNUP0709V	19	NTN	
	72,000	20,600	0,40	E-R0725V	17	NTN	
	72,000	20,600	0,39	R0725V	17	NTN	
	72,000	23,000	0,42	NJ2207	18	NTN	
	72,000	23,000	0,46	NJ2207E	18	NTN	
	72,000	23,000	0,42	NJ 2207 EG15	18	SNR	
	72,000	23,000	0,41	NU2207	17	NTN	
	72,000	23,000	0,46	NU2207E	17	NTN	
	72,000	23,000	0,41	NU 2207 EG15	17	SNR	
	72,000	23,000	0,42	NUP2207E	19	NTN	
	72,000	23,000	0,60	NUP 2207 EG15	19	SNR	
	72,000	24,000	0,41	R0788ZA	17	NTN	
	80,000	21,000	0,47	N307	20	NTN	
	80,000	21,000	0,51	N307E	20	NTN	
	80,000	21,000	0,48	N 307 EG15	20	SNR	
	80,000	21,000	0,49	NF307	22	NTN	
	80,000	21,000	0,49	NF307E	22	NTN	
	80,000	21,000	0,56	NFV307	22	NTN	
	80,000	21,000	0,49	NJ307	18	NTN	
	80,000	21,000	0,55	NJ307E	18	NTN	
	80,000	21,000	0,50	NJ 307 EG15	18	SNR	
	80,000	21,000	0,52	NJK307	18	NTN	
	80,000	21,000	0,48	NU307	17	NTN	
	80,000	21,000	0,55	NU307E	17	NTN	
	80,000	21,000	0,48	NU 307 EG15	17	SNR	
	80,000	21,000	0,49	NU307EJ	17	NTN	
	80,000	21,000	0,50	NUP307	19	NTN	
	80,000	21,000	0,55	NUP307E	19	NTN	
	80,000	21,000	0,51	NUP 307 EG15	19	SNR	
	80,000	21,000	0,55	NUP307EJ	19	NTN	
	80,000	31,000	0,71	NJ2307	18	NTN	
	80,000	31,000	0,78	NJ2307E	18	NTN	
	80,000	31,000	0,73	NJ 2307 EG15	18	SNR	
	80,000	31,000	0,73	NU2307	17	NTN	
	80,000	31,000	0,78	NU2307E	17	NTN	
	80,000	31,000	0,71	NU 2307 EG15	17	SNR	
	80,000	31,000	0,69	NUP2307	19	NTN	
	80,000	31,000	0,78	NUP2307E	19	NTN	
	80,000	31,000	0,56	R0739	17	NTN	
	88,860	17,000	1,38	R07A57V	17	NTN	
	88,860	17,000	1,38	R07A72V	17	NTN	
	90,000	23,000	0,74	R0733V	17	NTN	
	90,000	23,000	0,75	R07A23V	17	NTN	
	100,000	25,000	0,98	N407	20	NTN	
100,000	25,000	0,99	NJ407	18	NTN-SNR		
100,000	25,000	0,99	NU407	17	NTN-SNR		

d	D	B	Kg	Reference			
35,000	100,000	25,000	0,99	NUP407	19	NTN	
	100,000	36,000	1,80	SLX35X100X36	26	NTN	
35,110	66,000	16,700	0,23	R07A54V	17	NTN	
	66,000	16,700	0,000	R07A70V	17	NTN	
	67,000	19,450	0,35	R07A68V	17	NTN	
	67,000	19,450	0,29	R07A69V	17	NTN	
	67,000	19,600	0,35	R07A67V	17	NTN	
36,000	72,000	60,000	1,01	R0782D2	17	NTN	
37,500	60,000	16,000	0,13	RUS206E/60	23	NTN	
	62,000	16,000	0,16	RUS206EJC	23	NTN	
	62,000	20,000	0,26	RUS2206E	23	NTN	
38,000	70,000	35,000	0,50	R0895	17	NTN	
	70,000	35,000	0,50	R08A70	17	NTN	
	70,000	40,000	0,59	E-R08A67	17	NTN	
	70,000	40,000	0,59	E-R08A68	17	NTN	
	77,000	72,000	1,36	R08A17D2	17	NTN	
	83,000	25,400	0,96	E-RNF0820N	22	NTN	
38,300	150,000	138,000	11,01	R08A92VZZ	17	NTN	
38,400	150,000	138,000	12,50	R08A31V	17	NTN	
38,700	150,000	114,000	8,80	R0878VZZ	17	NTN	
39,000	78,500	34,000	0,71	RR0830	24	NTN	
40,000	62,000	20,000	0,19	R0868	17	NTN	
	62,000	22,000	0,23	SLX40X62X22	26	NTN	
	68,000	15,000	0,22	N1008	20	NTN	
	68,000	15,000	0,21	NJ1008	18	NTN	
	68,000	15,000	0,21	NU1008	17	NTN	
	68,000	15,000	0,22	NUP1008	19	NTN	
	68,000	38,000	0,56	SL04-5008LLN	26	NTN	
	68,000	38,000	0,56	SL04-5008LLNR	26	NTN	
	68,000	38,000	0,56	SL04-5008NR	26	NTN	
	73,526	32,500	0,49	R08A45	17	NTN	
	73,530	30,000	0,45	R0876	17	NTN	
	75,000	28,000	0,44	R08A20	17	NTN	
	80,000	18,000	0,37	N208	20	NTN	
	80,000	18,000	0,37	N208E	20	NTN	
	80,000	18,000	0,38	N 208 EG15	20	SNR	
	80,000	18,000	0,38	NF208	22	NTN	
	80,000	18,000	0,42	NF208E	22	NTN	
	80,000	18,000	0,39	NJ208	18	NTN	
	80,000	18,000	0,43	NJ208E	18	NTN	
	80,000	18,000	0,38	NJ 208 EG15	18	SNR	
	80,000	18,000	0,38	NU208	17	NTN	
80,000	18,000	0,43	NU208E	17	NTN		
80,000	18,000	0,38	NU 208 EG15	17	SNR		
80,000	18,000	0,43	NU 208 EM	17	SNR		
80,000	18,000	0,40	NU208K	17	NTN		
80,000	18,000	0,40	NUP208	19	NTN		
80,000	18,000	0,43	NUP208E	19	NTN		
80,000	18,000	0,43	NUP 208 EG15	19	SNR		
80,000	23,000	0,48	N2208	20	NTN		
80,000	23,000	0,50	NJ2208	18	NTN		
80,000	23,000	0,55	NJ2208E	18	NTN		
80,000	23,000	0,50	NJ 2208 EG15	18	SNR		

								Brands		
d	D	B	Kg	Reference						
40,000	80,000	23,000	0,49	NU2208	17	NTN				
	80,000	23,000	0,55	NU2208E	17	NTN				
	80,000	23,000	0,49	NU 2208 EG15	17	SNR				
	80,000	23,000	0,51	NUP2208	19	NTN				
	80,000	23,000	0,55	NUP2208E	19	NTN				
	80,000	23,000	0,51	NUP 2208 EG15	19	SNR				
	80,000	36,000	0,78	2RN0819	24	NTN				
	90,000	23,000	0,64	N308	20	NTN				
	90,000	23,000	0,64	N308E	20	NTN				
	90,000	23,000	0,65	N 308 EG15	20	SNR				
	90,000	23,000	0,67	NF308	22	NTN				
	90,000	23,000	0,67	NF308E	22	NTN				
	90,000	23,000	0,67	NJ308	18	NTN				
	90,000	23,000	0,75	NJ308E	18	NTN				
	90,000	23,000	0,67	NJ 308 EG15	18	SNR				
	90,000	23,000	0,69	NJK308	18	NTN				
	90,000	23,000	0,66	NU308	17	NTN				
	90,000	23,000	0,75	NU308E	17	NTN				
	90,000	23,000	0,66	NU 308 EG15	17	SNR				
	90,000	23,000	0,69	NUP308	19	NTN				
	90,000	23,000	0,75	NUP308E	19	NTN				
	90,000	23,000	0,68	NUP 308 EG15	19	SNR				
	90,000	28,000	1,19	R08A58V	17	NTN				
	90,000	30,000	0,84	NH308	21	NTN				
	90,000	33,000	0,93	N2308	20	NTN				
	90,000	33,000	1,06	NJ2308	18	NTN				
	90,000	33,000	1,06	NJ2308E	18	NTN				
	90,000	33,000	0,98	NJ 2308 EG15	18	SNR				
	90,000	33,000	1,01	NJK2308	18	NTN				
	90,000	33,000	0,94	NU2308	17	NTN				
	90,000	33,000	1,06	NU2308E	17	NTN				
	90,000	33,000	0,94	NU 2308 EG15	17	SNR				
	90,000	33,000	0,95	NUP2308	19	NTN				
	90,000	33,000	1,06	NUP2308E	19	NTN				
	95,000	39,000	1,11	SLX40X95X40	26	NTN				
	110,000	27,000	1,27	N408	20	NTN				
	110,000	27,000	1,22	NF408	22	NTN				
	110,000	27,000	1,33	NJ408	18	NTN-SNR				
	110,000	27,000	1,34	NU408	17	NTN-SNR				
	110,000	27,000	1,30	NUP408	19	NTN				
	140,000	55,000	4,22	R08A08VZZ	17	NTN				
	42,000	62,000	14,000	0,12	RUS1007	23	NTN			
		72,000	19,000	0,26	RUS306	23	NTN			
		120,000	41,000	1,91	R0897	17	NTN			
	43,800	72,000	23,000	0,33	RUS2207	23	NTN			
	44,000	72,000	17,000	0,24	RUS207E	23	NTN			
		72,000	69,000	0,99	RUS2207ED3	23	NTN			
45,000	75,000	16,000	0,28	N1009	20	NTN				
	75,000	16,000	0,28	NJ1009	18	NTN				
	75,000	16,000	0,28	NU1009	17	NTN				
	75,000	16,000	0,28	NUP1009	19	NTN				
	75,000	40,000	0,71	SL04-5009LLN	26	NTN				
	75,000	40,000	0,71	SL04-5009LLNR	26	NTN				
	75,000	40,000	0,69	SL04-5009NR	26	NTN				
	85,000	19,000	0,42	N209	20	NTN				
	85,000	19,000	0,42	N209E	20	NTN				
	85,000	19,000	0,45	N 209 EG15	20	SNR				
	85,000	19,000	0,44	NF209	22	NTN				

								Brands	
d	D	B	Kg	Reference					
45,000	85,000	19,000	0,44	NF209E	22	NTN			
	85,000	19,000	0,46	NFV209	22	NTN			
	85,000	19,000	0,44	NJ209	18	NTN			
	85,000	19,000	0,50	NJ209E	18	NTN			
	85,000	19,000	0,45	NJ 209 EG15	18	SNR			
	85,000	19,000	0,43	NU209	17	NTN			
	85,000	19,000	0,50	NU209E	17	NTN-SNR			
	85,000	19,000	0,44	NU 209 EG15	17	SNR			
	85,000	19,000	0,49	NU 209 EM	17	SNR			
	85,000	19,000	0,46	NUP209	19	NTN			
	85,000	19,000	0,50	NUP209E	19	NTN			
	85,000	19,000	0,46	NUP 209 EG15	19	SNR			
	85,000	19,000	0,47	NUP 209 ENRG15	19	SNR			
	85,000	23,000	0,52	N2209	20	NTN			
	85,000	23,000	0,54	NJ2209	18	NTN			
	85,000	23,000	0,60	NJ2209E	18	NTN			
	85,000	23,000	0,55	NJ 2209 EG15	18	SNR			
	85,000	23,000	0,53	NU2209	17	NTN			
	85,000	23,000	0,60	NU2209E	17	NTN			
	85,000	23,000	0,53	NU 2209 EG15	17	SNR			
	85,000	23,000	0,56	NUP2209	19	NTN			
	85,000	23,000	0,60	NUP2209E	19	NTN			
	85,000	23,000	0,54	NUP 2209 EG15	19	SNR			
	85,000	23,000	0,57	RNJ0922	18	NTN			
	86,060	25,000	0,61	E-R0949	17	NTN			
	95,000	23,000	0,79	NU2209E/95	17	NTN			
	97,000	36,000	1,27	NJ2309E/97	18	NTN			
	100,000	25,000	0,89	E-NF309	22	NTN			
	100,000	25,000	0,97	E-NJK309	18	NTN			
	100,000	25,000	0,86	N309	20	NTN			
	100,000	25,000	0,86	N309E	20	NTN			
	100,000	25,000	0,88	N 309 EG15	20	SNR			
	100,000	25,000	0,89	NF309	22	NTN			
	100,000	25,000	0,89	NF309E	22	NTN			
	100,000	25,000	0,88	NJ309	18	NTN			
	100,000	25,000	1,00	NJ309E	18	NTN			
	100,000	25,000	0,91	NJ 309 EG15	18	SNR			
	100,000	25,000	0,93	NJ309EJ	18	NTN			
	100,000	25,000	0,93	NJK309	18	NTN			
	100,000	25,000	0,86	NU309	17	NTN			
	100,000	25,000	1,00	NU309E	17	NTN			
	100,000	25,000	0,90	NU 309 EG15	17	SNR			
	100,000	25,000	1,07	NU 309 EM	17	SNR			
	100,000	25,000	0,88	NUP309	19	NTN			
	100,000	25,000	1,00	NUP309E	19	NTN			
	100,000	25,000	0,92	NUP 309 EG15	19	SNR			
	100,000	25,000	1,03	RNUP0913V	19	NTN			
	100,000	31,000	1,07	RT0913	36	NTN			
	100,000	32,000	1,09	NH309	21	NTN			
	100,000	32,000	1,14	RNJ0916V	18	NTN			
	100,000	36,000	1,24	N2309	20	NTN			
	100,000	36,000	1,27	NJ2309	18	NTN			
100,000	36,000	1,41	NJ2309E	18	NTN				
100,000	36,000	1,29	NJ 2309 EG15	18	SNR				
100,000	36,000	1,23	NU2309	17	NTN				
100,000	36,000	1,41	NU2309E	17	NTN				
100,000	36,000	1,29	NU 2309 EG15	17	SNR				
100,000	36,000	1,27	NUP2309	19	NTN				
100,000	36,000	1,41	NUP2309E	19	NTN				
120,000	29,000	1,58	N409	20	NTN				
120,000	29,000	1,62	NJ409	18	NTN-SNR				
120,000	29,000	1,62	NU409	17	NTN-SNR				

d	D	B	Kg	Reference	Brands
45,000	120,000	29,000	1,62	NUP409	19 NTN
	120,000	42,000	2,56	RNU0917	17 NTN
46,200	80,000	21,000	0,47	RUS307	23 NTN
47,550	70,630	27,000	0,31	R1063	17 NTN
47,600	72,000	17,000	0,22	RUS207	23 NTN
49,500	80,000	18,000	0,28	RUS208E	23 NTN
	120,000	60,000	1,86	R10A02	17 NTN
50,000	72,000	22,000	0,28	SL01-4910	26 NTN
	72,000	22,000	0,29	SL01-4910ZZ	26 NTN
	72,000	22,000	0,28	SL02-4910	26 NTN
	72,000	84,000	1,08	SL15-910D2	26 NTN
	72,100	16,000	0,19	R1041	17 NTN
	80,000	16,000	0,29	N1010	20 NTN
	80,000	16,000	0,30	NJ1010	18 NTN
	80,000	16,000	0,29	NU1010	17 NTN
	80,000	16,000	0,30	NUP1010	19 NTN
	80,000	18,000	0,28	RUS208	23 NTN
	80,000	20,000	0,37	R1033V	17 NTN
	80,000	23,000	0,39	R1040	17 NTN
	80,000	23,000	0,47	RUS2208	23 NTN
	80,000	40,000	0,74	SL04-5010LLNR	26 NTN
	80,000	40,000	0,76	SL04-5010NR	26 NTN
	90,000	20,000	0,48	N210	20 NTN
	90,000	20,000	0,48	N210E	20 NTN
	90,000	20,000	0,49	N 210 EG15	20 SNR
	90,000	20,000	0,50	NF210	22 NTN
	90,000	20,000	0,50	NF210E	22 NTN
	90,000	20,000	0,50	NJ210	18 NTN
	90,000	20,000	0,54	NJ210E	18 NTN
	90,000	20,000	0,50	NJ 210 EG15	18 SNR
	90,000	20,000	0,48	NU210	17 NTN
	90,000	20,000	0,54	NU210E	17 NTN-SNR
	90,000	20,000	0,49	NU 210 EG15	17 SNR
	90,000	20,000	0,56	NU 210 EM	17 SNR
	90,000	20,000	0,54	NUP210	19 NTN
	90,000	20,000	0,54	NUP210E	19 NTN
	90,000	20,000	0,52	NUP 210 EG15	19 SNR
	90,000	23,000	0,56	N2210	20 NTN
	90,000	23,000	0,57	NJ2210	18 NTN
	90,000	23,000	0,65	NJ2210E	18 NTN
	90,000	23,000	0,57	NJ 2210 EG15	18 SNR
	90,000	23,000	0,58	NJK2210	18 NTN
	90,000	23,000	0,57	NU2210	17 NTN
	90,000	23,000	0,65	NU2210E	17 NTN
	90,000	23,000	0,55	NU 2210 EG15	17 SNR
	90,000	23,000	0,57	NUP2210	19 NTN
	90,000	23,000	0,65	NUP2210E	19 NTN
	90,000	23,000	0,60	NUP 2210 EG15	19 SNR
	90,000	30,200	0,73	NU3210	17 NTN
	94,442	27,000	0,74	E-R1050	17 NTN
	96,000	80,000	2,29	R1062D2	17 NTN
	110,000	27,000	1,11	N310	20 NTN
	110,000	27,000	1,11	N310E	20 NTN
	110,000	27,000	1,15	N 310 EG15	20 SNR
	110,000	27,000	1,15	NF310	22 NTN
	110,000	27,000	1,15	NF310E	22 NTN
	110,000	27,000	1,16	NJ310	18 NTN

d	D	B	Kg	Reference	Brands
50,000	110,000	27,000	1,30	NJ310E	18 NTN
	110,000	27,000	1,18	NJ 310 EG15	18 SNR
	110,000	27,000	1,20	NJ310EJ	18 NTN
	110,000	27,000	1,25	NJK310	18 NTN
	110,000	27,000	1,13	NU310	17 NTN
	110,000	27,000	1,30	NU310E	17 NTN
	110,000	27,000	1,16	NU 310 EG15	17 SNR
	110,000	27,000	1,29	NU 310 EM	17 SNR
	110,000	27,000	1,19	NUP310	19 NTN
	110,000	27,000	1,30	NUP310E	19 NTN
	110,000	27,000	1,21	NUP 310 EG15	19 SNR
	110,000	32,000	1,44	RNUP1016V	19 NTN
	110,000	32,000	1,55	RNUP1019V	19 NTN
	110,000	35,500	0,000	RNUP1022V	19 NTN
	110,000	40,000	1,67	N2310	20 NTN
	110,000	40,000	1,70	NJ2310	18 NTN
	110,000	40,000	1,90	NJ2310E	18 NTN
	110,000	40,000	1,74	NJ 2310 EG15	18 SNR
	110,000	40,000	1,70	NU2310	17 NTN
	110,000	40,000	1,90	NU2310E	17 NTN
	110,000	40,000	1,74	NU 2310 EG15	17 SNR
	110,000	40,000	1,70	NUP2310	19 NTN
	110,000	40,000	1,90	NUP2310E	19 NTN
	110,000	44,400	2,30	RNUP1012	19 NTN
	110,000	45,500	1,98	2R1010K	24 NTN
	120,000	87,000	4,47	R1031	17 NTN
	130,000	31,000	1,97	N410	20 NTN
	130,000	31,000	2,09	NJ410	18 NTN
	130,000	31,000	2,36	NJ 410 M	18 SNR
	130,000	31,000	2,12	NU410	17 NTN-SNR
	130,000	31,000	2,02	NUP410	19 NTN
	130,000	60,000	4,63	SLX50X130X62	26 NTN
	156,000	70,000	8,00	R1099V	17 NTN
50,789	90,000	70,000	1,86	2R1013	24 NTN
50,800	80,000	21,000	0,40	RUS307E	23 NTN
53,500	90,000	23,000	0,48	RUS308	23 NTN
54,636	110,000	28,000	1,25	NJ2212E/54.636	18 NTN
55,000	85,000	23,000	0,42	R1131	17 NTN
	85,000	23,000	0,50	RUS2209	23 NTN
	90,000	18,000	0,41	N1011	20 NTN
	90,000	18,000	0,44	NJ1011	18 NTN
	90,000	18,000	0,44	NU1011	17 NTN
	90,000	18,000	0,44	NUP1011	19 NTN
	90,000	32,000	0,70	R11A11V	17 NTN
	90,000	46,000	1,09	SL04-5011LLNR	26 NTN
	90,000	46,000	1,09	SL04-5011N	26 NTN
	90,000	46,000	1,17	SL04-5011NR	26 NTN
	100,000	21,000	0,63	N211	20 NTN
	100,000	21,000	0,63	N211E	20 NTN
	100,000	21,000	0,67	N 211 EG15	20 SNR
	100,000	21,000	0,65	NF211	22 NTN
	100,000	21,000	0,65	NF211E	22 NTN
	100,000	21,000	0,65	NJ211	18 NTN
	100,000	21,000	0,72	NJ211E	18 NTN
	100,000	21,000	0,68	NJ 211 EG15	18 SNR
	100,000	21,000	0,64	NU211	17 NTN
	100,000	21,000	0,72	NU211E	17 NTN-SNR

d	D	B	Kg	Reference			Brands
55,000	100,000	21,000	0,64	NU 211 EG15	17		SNR
	100,000	21,000	0,74	NU 211 EM	17		SNR
	100,000	21,000	0,64	NUP211	19		NTN
	100,000	21,000	0,72	NUP211E	19		NTN
	100,000	21,000	0,69	NUP 211 EG15	19		SNR
	100,000	25,000	0,76	N2211	20		NTN
	100,000	25,000	0,76	N2211E	20		NTN
	100,000	25,000	0,79	NJ2211	18		NTN
	100,000	25,000	0,97	NJ2211E	18		NTN
	100,000	25,000	0,78	NJ 2211 EG15	18		SNR
	100,000	25,000	0,77	NU2211	17		NTN
	100,000	25,000	0,97	NU2211E	17		NTN
	100,000	25,000	0,78	NU 2211 EG15	17		SNR
	100,000	25,000	0,80	NUP2211	19		NTN
	100,000	25,000	0,97	NUP2211E	19		NTN
	100,000	25,000	0,83	NUP 2211 EG15	19		SNR
	100,000	31,000	1,04	RNUP1125V	19		NTN
	100,000	33,300	1,02	N3211	20		NTN
	100,000	54,102	1,77	RNU1145	17		NTN
	106,000	92,000	3,19	R1167D2	17		NTN
	120,000	29,000	1,60	E-NFV311	22		NTN
	120,000	29,000	1,41	N311	20		NTN
	120,000	29,000	1,41	N311E	20		NTN
	120,000	29,000	1,47	N 311 EG15	20		SNR
	120,000	29,000	1,46	NF311	22		NTN
	120,000	29,000	1,46	NF311E	22		NTN
	120,000	29,000	1,48	NJ311	18		NTN
	120,000	29,000	1,65	NJ311E	18		NTN
	120,000	29,000	1,50	NJ 311 EG15	18		SNR
	120,000	29,000	1,54	NJK311	18		NTN
	120,000	29,000	1,44	NU311	17		NTN
	120,000	29,000	1,65	NU311E	17		NTN
	120,000	29,000	1,47	NU 311 EG15	17		SNR
	120,000	29,000	1,61	NU 311 EM	17		SNR
	120,000	29,000	1,51	NUP311	19		NTN
	120,000	29,000	1,65	NUP311E	19		NTN
	120,000	29,000	1,53	NUP 311 EG15	19		SNR
	120,000	34,000	1,77	RNUP1117V	19		NTN
	120,000	43,000	2,37	E-NJ2311EHTG1	18		NTN
	120,000	43,000	2,13	N2311	20		NTN
	120,000	43,000	2,18	NJ2311	18		NTN
	120,000	43,000	2,37	NJ2311E	18		NTN
	120,000	43,000	2,23	NJ 2311 EG15	18		SNR
	120,000	43,000	2,11	NU2311	17		NTN
	120,000	43,000	2,37	NU2311E	17		NTN
	120,000	43,000	2,22	NU 2311 EG15	17		SNR
	120,000	43,000	2,17	NUP2311	19		NTN
	120,000	43,000	2,37	NUP2311E	19		NTN
	130,000	31,000	2,24	RNUP1115V	19		NTN
	130,000	36,700	2,39	RNUP1123V	19		NTN
	140,000	33,000	2,42	N411	20		NTN
	140,000	33,000	2,48	NJ411	18		NTN
	140,000	33,000	2,48	NU411	17		NTN
	140,000	33,000	2,48	NUP411	19		NTN
	140,000	81,000	6,96	SLX55X140X81	26		NTN
160,000	37,000	4,26	NUP315E/55	19		NTN	
56,000	160,000	63,000	7,22	R11A06VLL	17		NTN
58,000	160,000	70,000	7,40	R1275VZZ	17		NTN
58,052	147,380	65,532	4,42	R1778V	17		NTN

d	D	B	Kg	Reference			Brands
58,500	100,000	25,000	0,86	RUS309E	23		NTN
59,500	90,000	20,000	0,35	RUS210E	23		NTN
59,588	125,000	33,300	1,92	RNJ1224	18		NTN
60,000	85,000	25,000	0,45	SL01-4912	26		NTN
	85,000	25,000	0,47	SL01-4912ZZ	26		NTN
	85,000	25,000	0,44	SL02-4912	26		NTN
	85,000	98,000	1,75	SL15-912D2	26		NTN
	90,000	23,000	0,45	R1232	17		NTN
	90,000	125,000	2,60	SLX60X90X25	26		NTN
	95,000	18,000	0,47	N1012	20		NTN
	95,000	18,000	0,47	NJ1012	18		NTN
	95,000	18,000	0,47	NU1012	17		NTN
	95,000	18,000	0,47	NUP1012	19		NTN
	95,000	46,000	1,25	SL04-5012LLNR	26		NTN
	95,000	46,000	1,25	SL04-5012NR	26		NTN
	110,000	22,000	0,81	N212	20		NTN
	110,000	22,000	0,81	N212E	20		NTN
	110,000	22,000	0,83	N 212 EG15	20		SNR
	110,000	22,000	0,80	NF212	22		NTN
	110,000	22,000	0,80	NF212E	22		NTN
	110,000	22,000	0,84	NJ212	18		NTN
	110,000	22,000	0,92	NJ212E	18		NTN
	110,000	22,000	0,84	NJ 212 EG15	18		SNR
	110,000	22,000	0,87	NJK212	18		NTN
	110,000	22,000	0,82	NU212	17		NTN
	110,000	22,000	0,92	NU212E	17		NTN
	110,000	22,000	0,80	NU 212 EG15	17		SNR
	110,000	22,000	0,94	NU 212 EM	17		SNR
	110,000	22,000	0,92	NUP212	19		NTN
	110,000	22,000	0,92	NUP212E	19		NTN
	110,000	22,000	0,86	NUP 212 EG15	19		SNR
	110,000	25,000	1,67	E-RNF1218	22		NTN
	110,000	28,000	1,04	N2212	20		NTN
	110,000	28,000	1,04	N2212E	20		NTN
	110,000	28,000	1,10	NJ2212	18		NTN
	110,000	28,000	1,21	NJ2212E	18		NTN
	110,000	28,000	1,10	NJ 2212 EG15	18		SNR
	110,000	28,000	1,07	NU2212	17		NTN
	110,000	28,000	1,21	NU2212E	17		NTN
	110,000	28,000	1,08	NU 2212 EG15	17		SNR
	110,000	28,000	1,12	NUP2212	19		NTN
	110,000	28,000	1,21	NUP2212E	19		NTN
	110,000	28,000	1,13	NUP 2212 EG15	19		SNR
110,000	35,000	1,15	R1242	17		NTN	
110,000	84,000	3,47	SLX60X110X84	26		NTN	
130,000	25,000	1,62	NF215E/60	22		NTN	
130,000	31,000	1,96	E-NFV312	22		NTN	
130,000	31,000	1,96	E-NJ312E	18		NTN	
130,000	31,000	1,76	N312	20		NTN	
130,000	31,000	1,76	N312E	20		NTN	
130,000	31,000	1,81	N 312 EG15	20		SNR	
130,000	31,000	1,81	NF312	22		NTN	
130,000	31,000	1,81	NF312E	22		NTN	
130,000	31,000	1,83	NJ312	18		NTN	
130,000	31,000	2,05	NJ312E	18		NTN	
130,000	31,000	1,85	NJ 312 EG15	18		SNR	
130,000	31,000	1,80	NU312	17		NTN	
130,000	31,000	2,05	NU312E	17		NTN	
130,000	31,000	1,82	NU 312 EG15	17		SNR	

										Brands		
d	D	B	Kg	Reference								
60,000	130,000	31,000	2,04	NU 312 EM	17	SNR						
	130,000	31,000	1,87	NUP312	19	NTN						
	130,000	31,000	2,05	NUP312E	19	NTN						
	130,000	31,000	1,91	NUP 312 EG15	19	SNR						
	130,000	38,700	2,29	RNUP1216V	19	NTN						
	130,000	40,000	2,28	NH312	21	NTN						
	130,000	40,000	2,17	NH312E	21	NTN						
	130,000	46,000	2,66	N2312	20	NTN						
	130,000	46,000	2,70	NF2312	22	NTN						
	130,000	46,000	2,72	NJ2312	18	NTN						
	130,000	46,000	2,96	NJ2312E	18	NTN						
	130,000	46,000	2,83	NJ 2312 EG15	18	SNR						
	130,000	46,000	2,87	NJ2312EJX	18	NTN						
	130,000	46,000	3,12	NJ 2312 EM	18	SNR						
	130,000	46,000	2,65	NU2312	17	NTN						
	130,000	46,000	2,96	NU2312E	17	NTN						
	130,000	46,000	2,76	NU 2312 EG15	17	SNR						
	130,000	46,000	2,71	NUP2312	19	NTN						
	130,000	46,000	2,96	NUP2312E	19	NTN						
	130,000	54,000	3,40	RNUJ1215	18	NTN						
	130,000	55,000	3,13	NH2312	21	NTN						
	130,000	62,000	4,58	SLX60X130X62	26	NTN						
	145,000	53,000	4,50	SLX60X145X53	26	NTN						
	150,000	35,000	2,93	N412	20	NTN						
	150,000	35,000	3,03	NF412	22	NTN						
	150,000	35,000	3,19	NJ412	18	NTN						
	150,000	35,000	3,13	NU412	17	NTN						
	150,000	35,000	3,41	NU 412 M	17	SNR						
	150,000	35,000	3,00	NUP412	19	NTN						
	150,000	45,000	3,53	NH412	21	NTN						
	60,400	90,000	20,000	0,35	RUS210	23	NTN					
60,511	90,000	20,000	0,40	R1222	17	NTN						
60,543	90,041	20,000	0,38	E-R1230	17	NTN						
64,981	90,700	33,000	0,59	E-RR1313	24	NTN						
65,000	100,000	18,000	0,48	N1013	20	NTN						
	100,000	18,000	0,49	NJ1013	18	NTN						
	100,000	18,000	0,49	NU1013	17	NTN						
	100,000	18,000	0,49	NUP1013	19	NTN						
	100,000	46,000	1,33	SL04-5013LLNR	26	NTN						
	100,000	46,000	1,27	SL04-5013NR	26	NTN						
	105,600	23,000	0,65	RNH213	21	NTN						
	110,000	27,000	0,86	RUS310	23	NTN						
	110,000	27,000	0,94	RUS310E	23	NTN						
	110,000	80,000	2,60	RUS2310ED2	23	NTN						
	120,000	23,000	1,04	N213	20	NTN						
	120,000	23,000	1,04	N213E	20	NTN						
	120,000	23,000	1,05	N 213 EG15	20	SNR						
	120,000	23,000	1,08	NF213	22	NTN						
	120,000	23,000	1,08	NF213E	22	NTN						
	120,000	23,000	1,08	NJ213	18	NTN						
	120,000	23,000	1,21	NJ213E	18	NTN						
	120,000	23,000	1,07	NJ 213 EG15	18	SNR						
	120,000	23,000	1,05	NU213	17	NTN						
	120,000	23,000	1,21	NU213E	17	NTN						
	120,000	23,000	1,01	NU 213 EG15	17	SNR						
	120,000	23,000	1,18	NU 213 EM	17	SNR						
	120,000	23,000	1,20	NUP213	19	NTN						

										Brands		
d	D	B	Kg	Reference								
65,000	120,000	23,000	1,21	NUP213E	19	NTN						
	120,000	23,000	1,09	NUP 213 EG15	19	SNR						
	120,000	31,000	1,37	N2213	20	NTN						
	120,000	31,000	1,54	NF2213	22	NTN						
	120,000	31,000	1,48	NJ2213	18	NTN						
	120,000	31,000	1,60	NJ2213E	18	NTN						
	120,000	31,000	1,47	NJ 2213 EG15	18	SNR						
	120,000	31,000	1,45	NU2213	17	NTN						
	120,000	31,000	1,60	NU2213E	17	NTN						
	120,000	31,000	1,43	NU 2213 EG15	17	SNR						
	120,000	31,000	1,51	NUP2213	19	NTN						
	120,000	31,000	1,60	NUP2213E	19	NTN						
	120,000	33,000	1,68	RNUP1325	19	NTN						
	124,500	96,000	4,53	RNH2313	21	NTN						
	140,000	33,000	2,18	N313	20	NTN						
	140,000	33,000	2,18	N313E	20	NTN						
	140,000	33,000	2,24	N 313 EG15	20	SNR						
	140,000	33,000	2,23	NF313	22	NTN						
	140,000	33,000	2,23	NF313E	22	NTN						
	140,000	33,000	2,25	NJ313	18	NTN						
	140,000	33,000	2,54	NJ313E	18	NTN						
	140,000	33,000	2,30	NJ 313 EG15	18	SNR						
	140,000	33,000	2,19	NU313	17	NTN						
	140,000	33,000	2,54	NU313E	17	NTN						
	140,000	33,000	2,22	NU 313 EG15	17	SNR						
	140,000	33,000	2,53	NU 313 EM	17	SNR						
	140,000	33,000	2,30	NUP313	19	NTN						
	140,000	33,000	2,54	NUP313E	19	NTN						
	140,000	48,000	3,20	N2313	20	NTN						
	140,000	48,000	3,29	NJ2313	18	NTN						
	140,000	48,000	3,48	NJ2313E	18	NTN						
	140,000	48,000	3,38	NJ 2313 EG15	18	SNR						
	140,000	48,000	3,21	NU2313	17	NTN						
	140,000	48,000	3,48	NU2313E	17	NTN						
	140,000	48,000	3,32	NU 2313 EG15	17	SNR						
	140,000	48,000	3,60	NU 2313 EM	17	SNR						
	140,000	48,000	3,27	NUP2313	19	NTN						
	140,000	48,000	3,48	NUP2313E	19	NTN						
	140,000	100,000	6,54	R1344LL	17	NTN						
	160,000	37,000	3,50	N413	20	NTN						
	160,000	37,000	3,62	NF413	22	NTN						
	160,000	37,000	3,60	NJ413	18	NTN						
	160,000	37,000	3,60	NU413	17	NTN						
	160,000	37,000	3,60	NUP413	19	NTN						
	160,000	43,550	4,29	RNUP1323	19	NTN						
	160,000	43,550	4,29	RNUP1324	19	NTN						
	66,000	160,000	45,528	3,96	RNUP1517	19	NTN					
	66,500	100,000	25,000	0,61	RUS2211	23	NTN					
	67,000	122,000	35,000	1,87	RNUP1327	19	NTN					
68,000	175,000	75,000	8,42	R1462VZ	17	NTN						
69,850	104,770	17,460	0,51	RN1413	17	NTN						
	118,230	33,320	1,49	2RT1422	36	NTN						
70,000	100,000	30,000	0,76	SL01-4914	26	NTN						
	100,000	30,000	0,79	SL01-4914ZZ	26	NTN						
	100,000	30,000	0,74	SL02-4914	26	NTN						
	100,000	44,000	1,12	SL11-914	26	NTN						

d	D	B	Kg	Reference					
70,000	105,000	60,000	1,75	2R1418	24	NTN			
	105,000	94,000	2,70	2R1420	24	NTN			
	110,000	20,000	0,69	N1014	20	NTN			
	110,000	20,000	0,70	NJ1014	18	NTN			
	110,000	20,000	0,62	NU1014	17	NTN			
	110,000	20,000	0,70	NUP1014	19	NTN			
	110,000	28,000	0,93	R1431	17	NTN			
	110,000	54,000	1,85	SL04-5014LLNR	26	NTN			
	110,000	54,000	1,87	SL04-5014NR	26	NTN			
	125,000	24,000	1,20	N214	20	NTN			
	125,000	24,000	1,10	N214E	20	NTN			
	125,000	24,000	1,16	N 214 EG15	20	SNR			
	125,000	24,000	1,17	NF214	22	NTN			
	125,000	24,000	1,17	NF214E	22	NTN			
	125,000	24,000	1,17	NJ214	18	NTN			
	125,000	24,000	1,30	NJ214E	18	NTN			
	125,000	24,000	1,18	NJ 214 EG15	18	SNR			
	125,000	24,000	1,13	NU214	17	NTN			
	125,000	24,000	1,30	NU214E	17	NTN			
	125,000	24,000	1,17	NU 214 EG15	17	SNR			
	125,000	24,000	1,29	NU 214 EM	17	SNR			
	125,000	24,000	1,12	NUP214	19	NTN			
	125,000	24,000	1,30	NUP214E	19	NTN			
	125,000	24,000	1,21	NUP 214 EG15	19	SNR			
	125,000	24,000	1,10	R1425	17	NTN			
	125,000	31,000	1,44	N2214	20	NTN			
	125,000	31,000	1,53	NJ2214	18	NTN			
	125,000	31,000	1,70	NJ2214E	18	NTN			
	125,000	31,000	1,52	NJ 2214 EG15	18	SNR			
	125,000	31,000	1,51	NU2214	17	NTN			
	125,000	31,000	1,70	NU2214E	17	NTN			
	125,000	31,000	1,52	NU 2214 EG15	17	SNR			
	125,000	31,000	1,57	NUP2214	19	NTN			
	125,000	31,000	1,70	NUP2214E	19	NTN			
	125,000	39,700	1,70	NU3214	17	NTN			
	140,000	33,000	2,44	E-RNUP1415	19	NTN			
	150,000	35,000	2,65	N314	20	NTN			
	150,000	35,000	2,80	N 314 EG15	20	SNR			
	150,000	35,000	2,76	NF314	22	NTN			
	150,000	35,000	2,76	NF314E	22	NTN			
	150,000	35,000	2,78	NJ314	18	NTN			
	150,000	35,000	3,10	NJ314E	18	NTN			
	150,000	35,000	2,80	NJ 314 EG15	18	SNR			
	150,000	35,000	2,71	NU314	17	NTN			
	150,000	35,000	3,10	NU314E	17	NTN			
	150,000	35,000	2,75	NU 314 EG15	17	SNR			
	150,000	35,000	3,08	NU 314 EM	17	SNR			
	150,000	35,000	2,66	NUP314	19	NTN			
	150,000	35,000	3,10	NUP314E	19	NTN			
	150,000	35,000	3,05	RNUP1418	19	NTN			
	150,000	40,000	3,04	RNU1423ZZA	17	NTN			
	150,000	43,100	0,000	RNUP1425	19	NTN			
	150,000	51,000	3,90	N2314	20	NTN			
	150,000	51,000	4,08	NJ2314	18	NTN			
	150,000	51,000	4,25	NJ2314E	18	NTN			
	150,000	51,000	4,09	NJ 2314 EG15	18	SNR			
	150,000	51,000	3,97	NU2314	17	NTN			
	150,000	51,000	4,25	NU2314E	17	NTN			
	150,000	51,000	4,02	NU 2314 EG15	17	SNR			
	150,000	51,000	4,39	NU 2314 EM	17	SNR			
150,000	51,000	3,98	NUP2314	19	NTN				
150,000	51,000	4,25	NUP2314E	19	NTN				

d	D	B	Kg	Reference						
70,000	150,000	56,000	4,41	RNJ1419	18	NTN				
	150,000	56,500	4,63	2R1417K	24	NTN				
	150,000	63,500	5,20	NU3314	17	NTN				
	150,000	70,000	5,73	2RN1414	24	NTN				
	150,000	102,000	4,32	NJ2314EDF	18	NTN				
	160,000	95,000	4,53	R1424	17	NTN				
	178,000	60,000	8,60	R1453V	17	NTN				
	180,000	42,000	5,15	N414	20	NTN				
	180,000	42,000	5,65	NF414	22	NTN				
	180,000	42,000	5,33	NJ414	18	NTN				
	180,000	42,000	6,07	NJ 414 M	18	SNR				
	180,000	42,000	5,56	NU414	17	NTN				
	180,000	42,000	5,24	NUP414	19	NTN				
	180,000	54,000	5,97	NH414	21	NTN				
	72,000	102,000	12,500	0,19	2RT1419	36	NTN			
		110,000	22,000	0,59	RUS212E	23	NTN			
	73,333	115,000	20,000	0,000	NU1015/73.333	17	NTN			
	73,500	110,000	22,000	0,60	RUS212	23	NTN			
	74,500	100,000	18,000	0,37	RUS1013	23	NTN			
	75,000	115,000	20,000	0,73	N1015	20	NTN			
		115,000	20,000	0,72	NJ1015	18	NTN			
		115,000	20,000	0,74	NU1015	17	NTN			
115,000		20,000	0,74	NUP1015	19	NTN				
115,000		54,000	1,99	SL04-5015LLNR	26	NTN				
115,000		54,000	1,97	SL04-5015NR	26	NTN				
130,000		25,000	1,21	N215	20	NTN				
130,000		25,000	1,21	N215E	20	NTN				
130,000		25,000	1,28	N 215 EG15	20	SNR				
130,000		25,000	1,26	NF215	22	NTN				
130,000		25,000	1,30	NF215E	22	NTN				
130,000		25,000	1,26	NJ215	18	NTN				
130,000		25,000	1,41	NJ215E	18	NTN				
130,000		25,000	1,30	NJ 215 EG15	18	SNR				
130,000		25,000	1,22	NU215	17	NTN				
130,000		25,000	1,41	NU215E	17	NTN				
130,000		25,000	1,28	NU 215 EG15	17	SNR				
130,000		25,000	1,43	NU 215 EM	17	SNR				
130,000		25,000	1,30	NUP215	19	NTN				
130,000		25,000	1,41	NUP215E	19	NTN				
130,000		25,000	1,34	NUP 215 EG15	19	SNR				
130,000		31,000	1,63	N2215	20	NTN				
130,000		31,000	1,59	NJ2215	18	NTN				
130,000		31,000	1,79	NJ2215E	18	NTN				
130,000		31,000	1,59	NJ 2215 EG15	18	SNR				
130,000		31,000	1,55	NU2215	17	NTN				
130,000		31,000	1,79	NU2215E	17	NTN				
130,000		31,000	1,60	NU 2215 EG15	17	SNR				
130,000		31,000	1,62	NUP2215	19	NTN				
130,000		31,000	1,79	NUP2215E	19	NTN				
130,000		31,000	1,48	R1564V	17	NTN				
130,000		41,300	2,01	NU3215	17	NTN				
160,000	37,000	3,22	N315	20	NTN					
160,000	37,000	3,70	N 315 EG15	20	SNR					
160,000	37,000	3,53	NF315	22	NTN					
160,000	37,000	3,34	NJ315	18	NTN					
160,000	37,000	3,74	NJ315E	18	NTN					
160,000	37,000	3,30	NJ 315 EG15	18	SNR					

								Brands		
d	D	B	Kg	Reference						
75,000	160,000	37,000	3,27	NU315	17	NTN				
	160,000	37,000	3,74	NU315E	17	NTN				
	160,000	37,000	3,30	NU 315 EG15	17	SNR				
	160,000	37,000	3,73	NU 315 EM	17	SNR				
	160,000	37,000	3,28	NUP315	19	NTN				
	160,000	37,000	3,74	NUP315E	19	NTN				
	160,000	48,000	4,06	NH315	21	NTN				
	160,000	55,000	4,77	N2315	20	NTN				
	160,000	55,000	4,75	NJ2315	18	NTN				
	160,000	55,000	5,25	NJ2315E	18	NTN				
	160,000	55,000	5,04	NJ 2315 EG15	18	SNR				
	160,000	55,000	4,81	NU2315	17	NTN				
	160,000	55,000	5,25	NU2315E	17	NTN				
	160,000	55,000	4,95	NU 2315 EG15	17	SNR				
	160,000	55,000	6,00	NU 2315 EM	17	SNR				
	160,000	55,000	4,87	NUP2315	19	NTN				
	160,000	55,000	5,25	NUP2315E	19	NTN				
	160,000	60,000	5,55	RN1517	18	NTN				
	160,000	110,000	10,50	NJ2315EDF	18	NTN				
	190,000	45,000	6,06	N415	20	NTN				
	190,000	45,000	6,22	NJ415	18	NTN				
	190,000	45,000	6,22	NU415	17	NTN				
	190,000	45,000	6,22	NUP415	19	NTN				
	79,600	120,000	31,000	1,06	RUS2213	23	NTN			
	80,000	105,000	100,000	2,37	SLX80X105X25	26	NTN			
		110,000	30,000	0,84	SL01-4916	26	NTN			
		110,000	30,000	0,88	SL01-4916ZZ	26	NTN			
		110,000	30,000	0,83	SL02-4916	26	NTN			
110,000		60,000	1,77	SL01-4916ZZD2	26	NTN				
120,000		31,000	1,12	R1619	17	NTN				
120,000		45,000	1,75	SL05-016	26	NTN				
120,000		45,000	1,95	SL06-016	26	NTN				
125,000		22,000	0,97	N1016	20	NTN				
125,000		22,000	0,98	NJ1016	18	NTN				
125,000		22,000	0,10	NU1016	17	NTN				
125,000		22,000	0,98	NUP1016	19	NTN				
125,000		60,000	2,66	SL04-5016LLNR	26	NTN				
125,000		60,000	2,66	SL04-5016NR	26	NTN				
140,000		26,000	1,47	N216	20	NTN				
140,000		26,000	1,54	N 216 EG15	20	SNR				
140,000		26,000	1,51	NF216	22	NTN				
140,000		26,000	1,52	NJ216	18	NTN				
140,000		26,000	1,67	NJ216E	18	NTN				
140,000		26,000	1,54	NJ 216 EG15	18	SNR				
140,000		26,000	1,48	NU216	17	NTN				
140,000		26,000	1,67	NU216E	17	NTN				
140,000		26,000	1,54	NU 216 EG15	17	SNR				
140,000		26,000	1,71	NU 216 EM	17	SNR				
140,000		26,000	1,60	NUP216	19	NTN				
140,000		26,000	1,67	NUP216E	19	NTN				
140,000		33,000	1,89	N2216	20	NTN				
140,000		33,000	1,97	NJ2216	18	NTN				
140,000		33,000	2,12	NJ2216E	18	NTN				
140,000		33,000	2,04	NJ 2216 EG15	18	SNR				
140,000		33,000	1,94	NU2216	17	NTN				
140,000		33,000	2,12	NU2216E	17	NTN				
140,000		33,000	2,01	NU 2216 EG15	17	SNR				
140,000		33,000	2,01	NUP2216	19	NTN				
140,000		33,000	2,12	NUP2216E	19	NTN				
140,000		33,000	1,88	RNU1625	17	NTN				





								Brands		
d	D	B	Kg	Reference						
80,000	140,000	66,680	4,68	RNU1636	17	NTN				
	170,000	39,000	3,77	N316	20	NTN				
	170,000	39,000	3,77	N316E	20	NTN				
	170,000	39,000	3,93	N 316 EG15	20	SNR				
	170,000	39,000	3,96	NF316	22	NTN				
	170,000	39,000	3,98	NJ316	18	NTN				
	170,000	39,000	4,22	NJ316E	18	NTN				
	170,000	39,000	4,04	NJ 316 EG15	18	SNR				
	170,000	39,000	3,86	NU316	17	NTN				
	170,000	39,000	4,22	NU316E	17	NTN				
	170,000	39,000	3,96	NU 316 EG15	17	SNR				
	170,000	39,000	4,41	NU 316 EM	17	SNR				
	170,000	39,000	3,86	NUP316	19	NTN				
	170,000	39,000	4,22	NUP316E	19	NTN				
	170,000	39,000	4,11	NUP 316 EG15	19	SNR				
	170,000	44,290	0,000	RNUP1611	19	NTN				
	170,000	50,000	4,86	NH316	21	NTN				
	170,000	57,000	6,10	RNU1610	17	NTN				
	170,000	58,000	5,67	N2316	20	NTN				
	170,000	58,000	5,95	NF2316	22	NTN				
	170,000	58,000	6,00	NJ2316	18	NTN				
	170,000	58,000	6,25	NJ2316E	18	NTN				
	170,000	58,000	5,84	NU2316	17	NTN				
	170,000	58,000	6,25	NU2316E	17	NTN				
	170,000	58,000	6,00	NU 2316 EG15	17	SNR				
	170,000	58,000	6,50	NU 2316 EM	17	SNR				
	170,000	58,000	6,15	NUP2316	19	NTN				
	170,000	58,000	6,25	NUP2316E	19	NTN				
	170,000	64,500	7,78	2R1609K	24	NTN				
	170,000	65,000	7,13	RNJ1610	18	NTN				
	170,000	68,000	6,66	RNUJ1610	18	NTN				
	200,000	48,000	7,17	N416	20	NTN				
	200,000	48,000	6,97	NF416	22	NTN				
	200,000	48,000	7,87	NJ416	18	NTN				
	200,000	48,000	7,71	NU416	17	NTN				
	200,000	48,000	7,32	NUP416	19	NTN				
	81,480	107,950	25,000	0,45	E-RR1610	24	NTN			
	82,500	140,000	96,000	5,05	RUS2313ED2	23	NTN			
83,500	125,000	24,000	1,08	RUS214E	23	NTN				
83,779	140,050	33,000	1,93	E-R1745	17	NTN				
85,000	118,500	22,000	0,59	RNH1017	21	NTN				
	130,000	22,000	1,01	N1017	20	NTN				
	130,000	22,000	1,03	NJ1017	18	NTN				
	130,000	22,000	1,03	NU1017	17	NTN				
	130,000	22,000	1,03	NUP1017	19	NTN				
	130,000	60,000	2,79	SL04-5017LLNR	26	NTN				
	130,000	60,000	2,78	SL04-5017NR	26	NTN				
	140,000	33,000	0,000	E-RNUP1732	19	NTN				
	150,000	28,000	1,98	N217	20	NTN				
	150,000	28,000	1,91	N 217 EG15	20	SNR				
	150,000	28,000	1,85	NF217	22	NTN				
	150,000	28,000	1,93	NJ217	18	NTN				
	150,000	28,000	2,11	NJ217E	18	NTN				
	150,000	28,000	1,95	NJ 217 EG15	18	SNR				
	150,000	28,000	1,87	NU217	17	NTN				
	150,000	28,000	2,11	NU217E	17	NTN				
	150,000	28,000	1,91	NU 217 EG15	17	SNR				





										Brands		
d	D	B	Kg	Reference								
85,000	150,000	28,000	2,13	NU 217 EM	17	SNR						
	150,000	28,000	1,87	NUP217	19	NTN						
	150,000	28,000	2,11	NUP217E	19	NTN						
	150,000	36,000	2,39	N2217	20	NTN						
	150,000	36,000	2,38	NJ2217	18	NTN						
	150,000	36,000	2,68	NJ2217E	18	NTN						
	150,000	36,000	2,55	NJ 2217 EG15	18	SNR						
	150,000	36,000	2,47	NU2217	17	NTN						
	150,000	36,000	2,68	NU2217E	17	NTN						
	150,000	36,000	2,43	NU 2217 EG15	17	SNR						
	150,000	36,000	2,44	NUP2217	19	NTN						
	150,000	36,000	2,68	NUP2217E	19	NTN						
	150,000	36,000	2,02	RNU1744	17	NTN						
	150,000	40,000	2,90	RNJ1733	18	NTN						
	150,000	42,000	3,15	RNUP1734	19	NTN						
	150,000	100,000	7,00	2R1747	24	NTN						
	150,000	125,000	8,80	RNU1749	17	NTN						
	150,000	130,000	8,69	2R1748	24	NTN						
	180,000	41,000	4,44	N317	20	NTN						
	180,000	41,000	4,44	N317E	20	NTN						
	180,000	41,000	5,33	N 317 EM	20	SNR						
	180,000	41,000	4,92	NF317	22	NTN						
	180,000	41,000	4,59	NJ317	18	NTN						
	180,000	41,000	4,81	NJ317E	18	NTN						
	180,000	41,000	4,66	NJ 317 EG15	18	SNR						
	180,000	41,000	4,47	NU317	17	NTN						
	180,000	41,000	4,81	NU317E	17	NTN						
	180,000	41,000	4,57	NU 317 EG15	17	SNR						
	180,000	41,000	5,20	NU 317 EM	17	SNR						
	180,000	41,000	4,78	NUP317	19	NTN						
	180,000	41,000	5,10	NUP317E	19	NTN						
	180,000	41,000	4,76	NUP 317 EG15	19	SNR						
	180,000	53,000	5,76	NH317	21	NTN						
	180,000	60,000	6,57	N2317	20	NTN						
	180,000	60,000	6,86	NJ2317	18	NTN						
	180,000	60,000	7,16	NJ2317E	18	NTN						
	180,000	60,000	6,68	NU2317	17	NTN						
	180,000	60,000	7,16	NU2317E	17	NTN						
	180,000	60,000	6,85	NU 2317 EG15	17	SNR						
	180,000	60,000	6,92	NU2317K	17	NTN						
	180,000	60,000	6,70	NUP2317	19	NTN						
	180,000	60,000	7,16	NUP2317E	19	NTN						
	180,000	120,000	14,32	NJ2317EDF	18	NTN						
	200,000	101,000	8,04	R1743	17	NTN						
	210,000	52,000	9,20	N417	20	NTN						
	210,000	52,000	9,25	NF417	22	NTN						
	210,000	52,000	9,44	NJ417	18	NTN						
	210,000	52,000	9,24	NU417	17	NTN						
	210,000	66,000	10,42	NH417	21	NTN						
	89,000	150,000	102,000	6,13	RUS2314ED2	23	NTN					
	90,000	125,000	35,000	1,31	SL01-4918	26	NTN					
		125,000	35,000	1,29	SL02-4918	26	NTN					
		125,000	68,000	2,70	SL15-918	26	NTN					
		140,000	24,000	1,33	N1018	20	NTN					
140,000		24,000	1,33	NJ1018	18	NTN						
140,000		24,000	1,28	NU1018	17	NTN						
140,000		24,000	1,33	NUP1018	19	NTN						
140,000		67,000	3,64	SL04-5018LLNR	26	NTN						
140,000		67,000	3,71	SL04-5018NR	26	NTN						
145,000		84,000	5,38	4R1827	28	NTN						

										Brands	
d	D	B	Kg	Reference							
90,000	160,000	30,000	2,25	N218	20	NTN					
	160,000	30,000	2,35	N 218 EG15	20	SNR					
	160,000	30,000	2,36	NF218	22	NTN					
	160,000	30,000	2,38	NJ218	18	NTN					
	160,000	30,000	2,44	NJ218E	18	NTN					
	160,000	30,000	2,36	NJ 218 EG15	18	SNR					
	160,000	30,000	2,32	NU218	17	NTN					
	160,000	30,000	2,44	NU218E	17	NTN					
	160,000	30,000	2,35	NU 218 EG15	17	SNR					
	160,000	30,000	2,48	NU 218 EM	17	SNR					
	160,000	30,000	2,43	NUP218	19	NTN					
	160,000	30,000	2,44	NUP218E	19	NTN					
	160,000	39,000	2,92	NH218	21	NTN					
	160,000	40,000	3,04	N2218	20	NTN					
	160,000	40,000	3,86	NJ2218	18	NTN					
	160,000	40,000	3,33	NJ2218E	18	NTN					
	160,000	40,000	3,21	NJ 2218 EG15	18	SNR					
	160,000	40,000	3,09	NU2218	17	NTN					
	160,000	40,000	3,33	NU2218E	17	NTN					
	160,000	40,000	3,17	NU 2218 EG15	17	SNR					
	160,000	40,000	3,22	NUP2218	19	NTN					
	160,000	52,400	4,74	NU3218	17	NTN					
	160,000	67,000	8,30	SLX90X160X67	26	NTN					
	160,000	80,000	6,75	NJ2218DF	18	NTN					
	160,000	80,000	6,18	NU2218D2	17	NTN					
	160,000	112,000	8,47	R1845LL	17	NTN					
	190,000	43,000	5,74	E-NJ318AG1	18	NTN					
	190,000	43,000	5,18	N318	20	NTN					
	190,000	43,000	5,18	N318E	20	NTN					
	190,000	43,000	6,21	N 318 EM	20	SNR					
	190,000	43,000	5,41	NF318	22	NTN					
	190,000	43,000	5,40	NJ318	18	NTN					
	190,000	43,000	5,72	NJ318E	18	NTN					
	190,000	43,000	5,58	NJ 318 EG15	18	SNR					
	190,000	43,000	5,30	NU318	17	NTN					
	190,000	43,000	5,72	NU318E	17	NTN					
	190,000	43,000	5,34	NU 318 EG15	17	SNR					
	190,000	43,000	6,27	NU 318 EM	17	SNR					
	190,000	43,000	5,30	NUP318	19	NTN					
	190,000	43,000	5,72	NUP318E	19	NTN					
	190,000	64,000	7,79	N2318	20	NTN					
	190,000	64,000	8,16	NJ2318	18	NTN					
	190,000	64,000	8,56	NJ2318E	18	NTN					
	190,000	64,000	9,63	NJ 2318 EM	18	SNR					
	190,000	64,000	7,93	NU2318	17	NTN					
	190,000	64,000	8,56	NU2318E	17	NTN					
	190,000	64,000	8,00	NU 2318 EG15	17	SNR					
	190,000	64,000	7,76	NU2318K	17	NTN					
	190,000	64,000	7,95	NUP2318	19	NTN					
	190,000	64,000	8,56	NUP2318E	19	NTN					
	225,000	54,000	11,00	N418	20	NTN					
	225,000	54,000	11,30	NF418	22	NTN					
	225,000	54,000	11,40	NJ418	18	NTN					
	225,000	54,000	11,20	NU418	17	NTN					
225,000	68,000	12,37	NH418	21	NTN						
285,000	107,000	32,00	2R1842LLU	24	NTN						
95,000	122,984	18,000	0,47	E-R1939	17	NTN					
	145,000	24,000	1,38	N1019	20	NTN					
	145,000	24,000	1,37	NJ1019	18	NTN					
	145,000	24,000	1,40	NU1019	17	NTN					

										Brands	
d	D	B	Kg	Reference							
100,000	225,000	100,000	22,20	2R2067	24	NTN					
	240,000	107,000	13,40	R2039	17	NTN					
	250,000	58,000	15,40	NJ420	18	NTN					
	250,000	58,000	15,10	NU420	17	NTN					
	250,000	74,000	17,00	NH420	21	NTN					
	280,000	65,000	23,50	NJ422/100	18	NTN					
101,240	120,050	23,000	0,46	E-RR2035	24	NTN					
101,600	152,400	101,600	6,27	RNU2062	17	NTN					
	180,000	210,000	21,80	RNU2068	17	NTN					
	187,325	58,738	7,15	2RT2046	36	NTN					
103,652	120,000	29,000	0,63	E-RR2109	24	NTN					
105,000	160,000	26,000	1,83	N1021	20	NTN					
	160,000	26,000	1,89	NF1021	22	NTN					
	160,000	26,000	1,84	NJ1021	18	NTN					
	160,000	26,000	1,84	NU1021	17	NTN					
	160,000	26,000	1,84	NUP1021	19	NTN					
	165,000	64,000	5,19	E-2R2114V	24	NTN					
	165,000	64,000	5,19	E-2R2115V	24	NTN					
	190,000	36,000	3,95	N221	20	NTN					
	190,000	36,000	4,08	NF221	22	NTN					
	190,000	36,000	4,10	NJ221	18	NTN					
	190,000	36,000	4,08	NJ 221 EG15	18	SNR					
	190,000	36,000	3,95	NU221	17	NTN					
	190,000	36,000	4,06	NU 221 EG15	17	SNR					
	190,000	36,000	4,56	NU 221 EM	17	SNR					
	190,000	36,000	4,20	NUP221	19	NTN					
	190,000	65,100	8,25	NU3221	17	NTN					
	215,000	73,000	12,80	NJ2320E	18	NTN					
	215,000	73,000	12,80	NUP2320E	19	NTN					
	225,000	49,000	8,33	N321	20	NTN					
	225,000	49,000	9,44	NF321	22	NTN					
	225,000	49,000	9,49	NJ321	18	NTN					
	225,000	49,000	8,56	NU321	17	NTN					
	225,000	49,000	9,98	NU 321 EM	17	SNR					
	225,000	49,000	8,53	NUP321	19	NTN					
	260,000	60,000	16,00	N421	20	NTN					
	260,000	60,000	17,20	NJ421	18	NTN					
	260,000	60,000	16,80	NU421	17	NTN					
260,000	60,000	14,70	NU421K	17	NTN						
109,100	125,058	22,000	0,41	E-RR2232	24	NTN					
109,692	160,020	83,820	3,12	RNU2238	17	NTN					
110,000	138,000	150,000	27,20	2RNU2231	24	NTN					
	150,000	20,000	1,09	NU1922	17	NTN					
	150,000	24,000	1,20	R2238V	17	NTN					
	150,000	40,000	2,10	SL01-4922	26	NTN					
	150,000	40,000	2,06	SL02-4922	26	NTN					
	170,000	28,000	2,30	N1022	20	NTN					
	170,000	28,000	2,33	NJ1022	18	NTN					
	170,000	28,000	2,33	NU1022	17	NTN					
	170,000	28,000	2,33	NUP1022	19	NTN					
	170,000	60,000	4,30	R2260V	17	NTN					
	170,000	80,000	6,52	SL04-5022LLNR	26	NTN					
	170,000	80,000	6,52	SL04-5022NR	26	NTN					
	180,000	69,000	6,00	R2264HTV	17	NTN					
	200,000	38,000	4,64	N222	20	NTN					



										Brands	
d	D	B	Kg	Reference							
110,000	200,000	38,000	4,64	N222E	20	NTN					
	200,000	38,000	5,49	N 222 EM	20	SNR					
	200,000	38,000	5,05	NF222	22	NTN					
	200,000	38,000	4,80	NJ222	18	NTN					
	200,000	38,000	4,84	NJ222E	18	NTN					
	200,000	38,000	5,03	NJ 222 EG15	18	SNR					
	200,000	38,000	4,69	NU222	17	NTN					
	200,000	38,000	4,27	NU222E	17	NTN					
	200,000	38,000	4,94	NU 222 EG15	17	SNR					
	200,000	38,000	5,65	NU 222 EM	17	SNR					
	200,000	38,000	4,93	NUP222	19	NTN					
	200,000	38,000	4,27	NUP222E	19	NTN					
	200,000	53,000	6,43	N2222	20	NTN					
	200,000	53,000	6,70	NJ2222	18	NTN					
	200,000	53,000	7,40	NJ2222E	18	NTN					
	200,000	53,000	6,55	NU2222	17	NTN					
	200,000	53,000	7,40	NU2222E	17	NTN					
	200,000	53,000	6,73	NU 2222 EG15	17	SNR					
	200,000	53,000	6,86	NUP2222	19	NTN					
	200,000	53,000	7,40	NUP2222E	19	NTN					
	200,000	54,000	7,11	RNU2243	17	NTN					
	200,000	69,800	9,20	NU3222	17	NTN					
	200,000	69,850	9,84	R2221	17	NTN					
	200,000	69,850	9,96	RNU2223	17	NTN					
	200,000	88,900	13,10	RNU2226	17	NTN					
	240,000	50,000	9,77	N322	20	NTN					
	240,000	50,000	9,98	N322E	20	NTN					
	240,000	50,000	10,60	N 322 EM	20	SNR					
	240,000	50,000	10,60	NF322	22	NTN					
	240,000	50,000	10,00	NJ322	18	NTN					
	240,000	50,000	11,10	NJ322E	18	NTN					
	240,000	50,000	10,71	NJ 322 EG15	18	SNR					
	240,000	50,000	11,77	NJ 322 EM	18	SNR					
	240,000	50,000	10,00	NU322	17	NTN					
	240,000	50,000	11,10	NU322E	17	NTN					
	240,000	50,000	10,37	NU 322 EG15	17	SNR					
	240,000	50,000	11,60	NU 322 EM	17	SNR					
240,000	50,000	10,70	NUP322	19	NTN						
240,000	50,000	11,10	NUP322E	19	NTN						
240,000	80,000	16,80	N2322	20	NTN						
240,000	80,000	18,00	NJ2322	18	NTN						
240,000	80,000	19,40	NJ2322E	18	NTN						
240,000	80,000	18,60	NJ 2322 EM	18	SNR						
240,000	80,000	17,10	NU2322	17	NTN						
240,000	80,000	17,30	NU2322E	17	NTN						
240,000	80,000	18,21	NU 2322 EM	17	SNR						
240,000	80,000	17,20	NU2322K	17	NTN						
240,000	80,000	17,10	NUP2322	19	NTN						
240,000	80,000	19,40	NUP2322E	19	NTN						
240,000	92,100	20,20	NU3322A	17	NTN						
240,000	93,000	18,80	RNUJ2224	18	NTN						
240,000	160,000	35,60	NJ2322EDF	18	NTN						
260,000	92,000	25,80	RNF2206	22	NTN						
260,325	92,000	25,60	RNF2223	22	NTN						
265,000	110,000	27,60	R2227	17	NTN						
265,000	110,000	17,10	R2230	17	NTN						
280,000	65,000	21,40	NU422	17	NTN						
114,300	200,000	220,000	27,84	RNU2313	17	NTN					
115,000	250,000	53,000	12,80	RNJ2304	18	NTN					



								Brands	
d	D	B	Kg	Reference					
120,000	165,000	22,000	1,48	NU1924	17	NTN			
	165,000	27,000	1,81	NU2924	17	NTN			
	165,000	45,000	2,95	SL01-4924	26	NTN			
	165,000	45,000	2,81	SL02-4924	26	NTN			
	165,000	66,000	4,22	SL11-924	26	NTN			
	180,000	28,000	2,40	N1024	20	NTN			
	180,000	28,000	2,51	NJ1024	18	NTN			
	180,000	28,000	2,45	NU1024	17	NTN			
	180,000	28,000	2,44	NUP1024	19	NTN			
	180,000	46,000	4,30	R2494	17	NTN			
	180,000	60,000	5,55	SL05-024	26	NTN			
	180,000	80,000	6,76	SL04-5024LLN	26	NTN			
	180,000	80,000	7,12	SL04-5024LLNR	26	NTN			
	180,000	80,000	6,90	SL04-5024N	26	NTN			
	180,000	80,000	7,03	SL04-5024NR	26	NTN			
	180,000	92,000	8,20	4R2437	28	NTN			
	180,000	105,000	9,30	4R2438	28	NTN			
	200,000	80,000	9,74	2R2480	24	NTN			
	200,000	80,000	9,94	2R2481	24	NTN			
	215,000	40,000	5,46	N224	20	NTN			
	215,000	40,000	5,78	NF224	22	NTN			
	215,000	40,000	5,57	NJ224	18	NTN			
	215,000	40,000	6,12	NJ224E	18	NTN			
	215,000	40,000	6,04	NJ 224 EG15	18	SNR			
	215,000	40,000	5,72	NU224	17	NTN			
	215,000	40,000	5,97	NU224E	17	NTN			
	215,000	40,000	5,91	NU 224 EG15	17	SNR			
	215,000	40,000	6,64	NU 224 EM	17	SNR			
	215,000	40,000	5,57	NUP224	19	NTN			
	215,000	40,000	5,97	NUP224E	19	NTN			
	215,000	51,000	6,91	NH224	21	NTN			
	215,000	58,000	8,03	N2224	20	NTN			
	215,000	58,000	8,43	NJ2224	18	NTN			
	215,000	58,000	9,18	NJ2224E	18	NTN			
	215,000	58,000	8,22	NU2224	17	NTN			
	215,000	58,000	9,18	NU2224E	17	NTN			
	215,000	58,000	8,39	NU 2224 EG15	17	SNR			
	215,000	58,000	8,64	NUP2224	19	NTN			
	215,000	58,000	9,18	NUP2224E	19	NTN			
	215,000	76,000	12,20	NU3224	17	NTN			
	215,000	98,425	14,72	RNU2421	17	NTN			
	220,000	240,000	30,00	2R2482LL	24	NTN			
	220,000	282,000	34,90	2R2472LL	24	NTN			
	220,000	296,000	33,30	2R2486LL	24	NTN			
	220,000	308,500	35,80	2R2492LL	24	NTN			
	240,000	75,000	14,80	2RT2420	36	NTN			
	260,000	55,000	13,90	N324	20	NTN			
	260,000	55,000	14,94	N 324 EM	20	SNR			
	260,000	55,000	14,20	NF324	22	NTN			
	260,000	55,000	13,30	NJ324	18	NTN			
	260,000	55,000	13,90	NJ324E	18	NTN			
	260,000	55,000	13,54	NJ 324 EG15	18	SNR			
	260,000	55,000	15,37	NJ 324 EM	18	SNR			
	260,000	55,000	12,80	NU324	17	NTN			
	260,000	55,000	13,90	NU324E	17	NTN			
	260,000	55,000	13,57	NU 324 EG15	17	SNR			
	260,000	55,000	13,60	NUP324	19	NTN			
	260,000	55,000	13,90	NUP324E	19	NTN			
	260,000	69,000	15,70	NH324	21	NTN			
	260,000	86,000	21,10	N2324	20	NTN			
260,000	86,000	22,60	NJ2324	18	NTN				
260,000	86,000	26,10	NJ2324E	18	NTN				

								Brands		
d	D	B	Kg	Reference						
120,000	260,000	86,000	23,80	NJ 2324 EM	18	SNR				
	260,000	86,000	22,10	NU2324	17	NTN				
	260,000	86,000	26,10	NU2324E	17	NTN				
	260,000	86,000	23,19	NU 2324 EM	17	SNR				
	260,000	86,000	21,50	NUP2324	19	NTN				
	260,000	86,000	26,10	NUP2324E	19	NTN				
	260,000	106,000	27,10	NU3324	17	NTN				
	260,000	110,000	29,60	NJ324EDF	18	NTN				
	310,000	72,000	29,90	NJ424	18	NTN				
	310,000	72,000	29,30	NU424	17	NTN				
	125,000	230,000	120,000	16,90	RNU2514	17	NTN			
	126,873	215,900	61,913	10,30	R2515	17	NTN			
	126,987	215,900	61,912	9,75	R2514	17	NTN			
	127,000	254,000	114,300	26,90	RE2512	17	NTN			
	129,000	211,000	124,000	17,81	4R2636	28	NTN			
	130,000	180,000	24,000	1,95	NU1926	17	NTN			
180,000		30,000	2,44	NU2926	17	NTN				
180,000		30,000	2,30	R2645V	17	NTN				
180,000		50,000	3,87	2R2677V	24	NTN				
180,000		50,000	3,85	SL01-4926	26	NTN				
180,000		50,000	3,75	SL02-4926	26	NTN				
200,000		33,000	3,49	N1026	20	NTN				
200,000		33,000	3,79	NJ1026	18	NTN				
200,000		33,000	3,69	NU1026	17	NTN				
200,000		33,000	3,69	NUP1026	19	NTN				
200,000		65,000	7,55	SL05-026	26	NTN				
200,000		65,000	8,10	SL06-026	26	NTN				
200,000		69,000	8,39	R2674	17	NTN				
200,000		95,000	10,60	SL04-5026LLNR	26	NTN				
200,000		95,000	10,40	SL04-5026N	26	NTN				
200,000		95,000	10,60	SL04-5026NR	26	NTN				
200,000		104,000	12,10	4R2628	28	NTN				
200,000		113,000	12,40	SLX130X200X114	26	NTN				
210,000		80,000	9,30	R2675HTV	17	NTN				
210,000		132,000	20,00	E-SL30X210X132ZZ	26	NTN				
210,000		132,000	20,00	E-SLX130X210X132	26	NTN				
210,000		132,000	20,00	E-SLX130X210X132ZZ	26	NTN				
210,000		150,000	22,00	E-SL30X210X150	26	NTN				
210,000		150,000	22,00	E-SLX130X210X150	26	NTN				
220,000		60,000	9,80	SLX130X220X120	26	NTN				
220,000		150,000	13,70	SLX130X220X150	26	NTN				
230,000		40,000	6,42	N226	20	NTN				
230,000		40,000	6,96	NF226	22	NTN				
230,000	40,000	6,66	NJ226	18	NTN					
230,000	40,000	6,90	NJ226E	18	NTN					
230,000	40,000	6,71	NJ 226 EG15	18	SNR					
230,000	40,000	6,50	NU226	17	NTN					
230,000	40,000	6,72	NU226E	17	NTN					
230,000	40,000	6,56	NU 226 EG15	17	SNR					
230,000	40,000	7,37	NU 226 EM	17	SNR					
230,000	40,000	6,30	NUP226	19	NTN					
230,000	40,000	6,90	NUP226E	19	NTN					
230,000	64,000	10,00	N2226	20	NTN					
230,000	64,000	10,60	NJ2226	18	NTN					
230,000	64,000	11,80	NJ2226E	18	NTN					
230,000	64,000	10,30	NU2226	17	NTN					

d	D	B	Kg	Reference						
130,000	230,000	64,000	11,80	NU2226E	17	NTN				
	230,000	64,000	10,40	NU 2226 EG15	17	SNR				
	230,000	64,000	10,20	NUP2226	19	NTN				
	230,000	64,000	11,80	NUP2226E	19	NTN				
	230,000	79,375	14,50	RNU2622	17	NTN				
	230,000	80,000	14,60	NU3226	17	NTN				
	230,000	80,000	14,70	R2625	17	NTN				
	235,000	170,000	28,80	2RNUP2653	24	NTN				
	240,000	209,000	34,40	2R2670LL	24	NTN				
	250,000	95,000	20,80	SL30X250X95	26	NTN				
	280,000	58,000	17,00	N326	20	NTN				
	280,000	58,000	18,44	N 326 EM	20	SNR				
	280,000	58,000	17,36	NF326	22	NTN				
	280,000	58,000	17,60	NJ326	18	NTN				
	280,000	58,000	19,40	NJ326E	18	NTN				
	280,000	58,000	16,75	NJ 326 EG15	18	SNR				
	280,000	58,000	19,04	NJ 326 EM	18	SNR				
	280,000	58,000	17,20	NU326	17	NTN				
	280,000	58,000	19,40	NU326E	17	NTN				
	280,000	58,000	16,46	NU 326 EG15	17	SNR				
	280,000	58,000	17,40	NUP326	19	NTN				
	280,000	58,000	19,40	NUP326E	19	NTN				
	280,000	93,000	26,40	N2326	20	NTN				
	280,000	93,000	28,00	NJ2326	18	NTN				
	280,000	93,000	30,90	NJ2326E	18	NTN				
	280,000	93,000	29,20	NJ 2326 EM	18	SNR				
	280,000	93,000	27,50	NU2326	17	NTN				
	280,000	93,000	30,90	NU2326E	17	NTN				
	280,000	93,000	28,73	NU 2326 EM	17	SNR				
	280,000	93,000	26,90	NUP2326	19	NTN				
	280,000	93,000	30,90	NUP2326E	19	NTN				
	280,000	94,000	27,16	RNU2654	17	NTN				
	280,000	112,000	33,10	NU3326	17	NTN				
	280,000	215,000	58,80	2RNU2625	24	NTN				
	300,000	172,640	70,00	3RCS2626	27	NTN				
	300,000	172,640	70,00	3RCS2660	27	NTN				
	300,000	172,640	70,00	3RCS2666	27	NTN				
	300,000	172,640	70,00	3RCS2668	27	NTN				
	300,000	172,640	73,30	3RCS2671	27	NTN				
	305,000	150,000	29,20	R2635	17	NTN				
	340,000	78,000	39,40	NJ426	18	NTN				
	340,000	78,000	38,60	NU426	17	NTN				
	140,000	190,000	30,000	2,59	NU2928	17	NTN			
		190,000	30,000	2,51	R2841V	17	NTN			
		190,000	50,000	4,20	SL01-4928	26	NTN			
		190,000	50,000	3,98	SL02-4928	26	NTN			
190,000		119,000	9,93	4R2832	28	NTN				
210,000		33,000	3,98	N1028	20	NTN				
210,000		33,000	4,12	N1028K	20	NTN				
210,000		33,000	4,05	NJ1028	18	NTN				
210,000		33,000	3,86	NU1028	17	NTN				
210,000		33,000	4,05	NUP1028	19	NTN				
210,000		53,000	6,80	NU3028	17	NTN				
210,000		63,000	7,03	RNN2823K	24	NTN				
210,000		69,000	9,37	R2869V	17	NTN				
210,000		80,000	9,00	SLX140X210X80	26	NTN				
210,000		95,000	11,30	SL04-5028LLNR	26	NTN				
210,000		95,000	10,60	SL04-5028NR	26	NTN				
210,000		116,000	13,90	4R2823	28	NTN				
210,000		130,000	21,00	E-SL40X210X130	26	NTN				
210,000		130,000	21,00	E-SLX140X210X130	26	NTN				

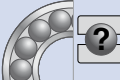
d	D	B	Kg	Reference					
140,000	220,000	36,000	4,24	RN2820	17	NTN			
	220,000	120,000	16,00	2RE2827	24	NTN			
	220,000	120,000	16,00	2RE2828	24	NTN			
	250,000	42,000	8,56	N228	20	NTN			
	250,000	42,000	9,34	N 228 EM	20	SNR			
	250,000	42,000	8,81	NJ228	18	NTN			
	250,000	42,000	8,73	NJ228E	18	NTN			
	250,000	42,000	9,31	NJ 228 EM	18	SNR			
	250,000	42,000	8,20	NU228	17	NTN			
	250,000	42,000	8,73	NU228E	17	NTN			
	250,000	42,000	9,59	NU 228 EM	17	SNR			
	250,000	42,000	7,88	NUP228	19	NTN			
	250,000	42,000	8,73	NUP228E	19	NTN			
	250,000	68,000	12,60	N2228	20	NTN			
	250,000	68,000	14,21	NJ2228	18	NTN			
	250,000	68,000	15,80	NJ2228E	18	NTN			
	250,000	68,000	13,10	NU2228	17	NTN			
	250,000	68,000	15,80	NU2228E	17	NTN			
	250,000	68,000	12,90	NUP2228	19	NTN			
	250,000	68,000	15,80	NUP2228E	19	NTN			
	250,000	68,000	15,30	R2856	17	NTN			
	250,000	82,550	17,80	R2812	17	NTN			
	250,000	88,000	19,10	NU3228	17	NTN			
	300,000	62,000	20,80	N328	20	NTN			
	300,000	62,000	22,65	N 328 EM	20	SNR			
	300,000	62,000	21,40	NF328	22	NTN			
	300,000	62,000	21,40	NJ328	18	NTN			
	300,000	62,000	23,20	NJ328E	18	NTN			
	300,000	62,000	21,20	NU328	17	NTN			
	300,000	62,000	23,20	NU328E	17	NTN			
	300,000	62,000	20,39	NU 328 EG15	17	SNR			
	300,000	62,000	22,47	NU 328 EM	17	SNR			
	300,000	62,000	21,20	NUP328	19	NTN			
	300,000	62,000	23,20	NUP328E	19	NTN			
	300,000	102,000	36,40	E-NJ328E	18	NTN			
	300,000	102,000	33,10	N2328	20	NTN			
	300,000	102,000	34,90	NJ2328	18	NTN			
	300,000	102,000	38,70	NJ2328E	18	NTN			
	300,000	102,000	34,10	NU2328	17	NTN			
	300,000	102,000	38,70	NU2328E	17	NTN			
	300,000	102,000	36,00	NU 2328 EM	17	SNR			
	300,000	102,000	33,80	NUP2328	19	NTN			
	300,000	102,000	38,70	NUP2328E	19	NTN			
	300,000	114,000	43,38	RNF2804	22	NTN			
	300,000	114,000	43,38	RNF2826	22	NTN			
	360,000	82,000	44,50	N428	20	NTN			
360,000	82,000	45,30	NU428	17	NTN				
360,000	100,000	50,05	NH428	21	NTN				
145,000	210,000	85,000	10,00	2R2904V	24	NTN			
	210,000	155,000	17,60	4R2906	28	NTN			
	225,000	156,000	23,30	4R2904	28	NTN			
	225,000	156,000	23,40	4R2908	28	NTN			
	285,000	124,000	13,10	RR2904	24	NTN			
	150,000	190,000	40,000	2,74	SL01-4830	26	NTN		
190,000		40,000	2,80	SL02-4830	26	NTN			
210,000		28,000	2,98	NJ1930	18	NTN			
210,000		28,000	3,17	NU1930	17	NTN			
210,000		36,000	4,08	NU2930	17	NTN			
210,000		60,000	6,47	SL01-4930	26	NTN			
210,000		60,000	6,26	SL02-4930	26	NTN			

								Brands	
d	D	B	Kg	Reference					
150,000	210,000	62,000	4,85	RN3032	17	NTN			
	210,000	65,000	7,08	2R3061V	24	NTN			
	210,000	70,000	7,17	RNN3025	24	NTN			
	220,000	127,000	15,70	4R3036	28	NTN			
	220,000	150,000	19,40	4R3031	28	NTN			
	220,000	150,000	20,50	4R3047	28	NTN			
	220,000	150,000	19,60	4R3056	28	NTN			
	225,000	35,000	4,70	N1030	20	NTN			
	225,000	35,000	4,77	NJ1030	18	NTN			
	225,000	35,000	4,77	NU1030	17	NTN			
	225,000	35,000	4,77	NUP1030	19	NTN			
	225,000	70,000	9,54	NU1030D2	17	NTN			
	225,000	75,000	11,70	R3062V	17	NTN			
	225,000	75,000	11,20	R3063HTV	17	NTN			
	225,000	100,000	13,20	SL04-5030LLN	26	NTN			
	225,000	100,000	13,60	SL04-5030LLNR	26	NTN			
	225,000	100,000	13,60	SL04-5030NR	26	NTN			
	225,000	123,000	16,40	SLX150X225X124	26	NTN			
	230,000	130,000	20,00	4R3029	28	NTN			
	230,000	156,000	23,50	4R3040	28	NTN			
	230,000	168,000	25,80	4R3042	28	NTN			
	250,000	100,000	19,80	2R3050	24	NTN			
	250,000	100,000	19,80	2R3051	24	NTN			
	250,000	150,000	29,60	4R3039	28	NTN			
	255,000	169,000	30,50	RE3036V	17	NTN			
	270,000	45,000	9,72	N230	20	NTN			
	270,000	45,000	11,10	NF230	22	NTN			
	270,000	45,000	10,50	NJ230	18	NTN			
	270,000	45,000	11,00	NJ230E	18	NTN			
	270,000	45,000	12,20	NJ 230 EM	18	SNR			
	270,000	45,000	10,30	NU230	17	NTN			
	270,000	45,000	11,00	NU230E	17	NTN			
	270,000	45,000	12,00	NU 230 EM	17	SNR			
	270,000	45,000	9,92	NUP230	19	NTN			
	270,000	45,000	11,00	NUP230E	19	NTN			
	270,000	57,000	12,29	NH230	21	NTN			
	270,000	73,000	16,00	N2230	20	NTN			
	270,000	73,000	16,30	NJ2230	18	NTN			
	270,000	73,000	19,70	NJ2230E	18	NTN			
	270,000	73,000	16,70	NU2230	17	NTN			
	270,000	73,000	19,70	NU2230E	17	NTN			
	270,000	73,000	15,90	NUP2230	19	NTN			
	270,000	73,000	19,70	NUP2230E	19	NTN			
	270,000	96,000	24,50	NU3230	17	NTN			
	270,000	125,000	19,70	RNU3066	17	NTN			
	320,000	65,000	24,70	N330	20	NTN			
	320,000	65,000	27,57	N 330 EM	20	SNR			
	320,000	65,000	25,50	NF330	22	NTN			
	320,000	65,000	25,30	NJ330	18	NTN			
	320,000	65,000	28,40	NJ330E	18	NTN			
320,000	65,000	24,70	NU330	17	NTN				
320,000	65,000	28,40	NU330E	17	NTN				
320,000	65,000	27,30	NU 330 EM	17	SNR				
320,000	65,000	25,30	NUP330	19	NTN				
320,000	65,000	28,40	NUP330E	19	NTN				
320,000	108,000	39,80	N2330	20	NTN				
320,000	108,000	42,10	NJ2330	18	NTN				
320,000	108,000	47,20	NJ2330E	18	NTN				
320,000	108,000	40,60	NU2330	17	NTN				
320,000	108,000	47,20	NU2330E	17	NTN				
320,000	108,000	43,20	NU 2330 EM	17	SNR				
320,000	108,000	40,50	NU2330K	17	NTN				

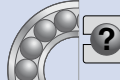
								Brands	
d	D	B	Kg	Reference					
150,000	320,000	108,000	40,60	NUP2330	19	NTN			
	320,000	108,000	47,20	NUP2330E	19	NTN			
	320,000	123,825	50,31	R3025V	17	NTN			
	380,000	85,000	52,10	NU430	17	NTN			
151,500	230,000	168,000	25,00	2R3055K	24	NTN			
	230,000	168,000	25,40	4R3033K	28	NTN			
158,750	285,648	63,500	16,60	RNJ3215	18	NTN			
160,000	200,000	40,000	2,86	SL01-4832	26	NTN			
	200,000	40,000	2,85	SL02-4832	26	NTN			
	220,000	28,000	3,35	NU1932	17	NTN			
	220,000	36,000	4,30	NU2932	17	NTN			
	220,000	60,000	7,00	SL01-4932	26	NTN			
	220,000	60,000	6,64	SL02-4932	26	NTN			
	220,000	180,000	20,20	4R3224	28	NTN			
	230,000	130,000	16,60	4R3226	28	NTN			
	230,000	168,000	23,20	4R3229	28	NTN			
	230,000	168,000	22,90	4R3231	28	NTN			
	230,000	168,000	23,40	4R3232	28	NTN			
	230,000	168,000	26,00	4R3243	28	NTN			
	230,000	180,000	25,50	4R3228	28	NTN			
	240,000	38,000	5,81	N1032	20	NTN			
	240,000	38,000	5,90	NJ1032	18	NTN			
	240,000	38,000	5,90	NU1032	17	NTN			
	240,000	38,000	5,90	NUP1032	19	NTN			
	240,000	60,000	8,29	R3230	17	NTN			
	240,000	80,000	1,80	R3263HTV	17	NTN			
	240,000	109,000	16,80	SL04-5032LLNR	26	NTN			
	240,000	109,000	16,80	SL04-5032NR	26	NTN			
	240,000	170,000	27,80	4R3225	28	NTN			
	250,000	70,000	12,30	RNN3215	24	NTN			
	270,000	86,000	20,60	NU3132	17	NTN			
	290,000	48,000	13,40	N232	20	NTN			
	290,000	48,000	13,80	NF232	22	NTN			
	290,000	48,000	13,70	NJ232	18	NTN			
	290,000	48,000	14,00	NJ232A	18	NTN			
	290,000	48,000	15,60	NJ232E	18	NTN			
	290,000	48,000	15,30	NJ 232 EM	18	SNR			
	290,000	48,000	13,70	NU232	17	NTN			
	290,000	48,000	13,70	NU232E	17	NTN			
	290,000	48,000	3,34	NU 232E M	17	SNR			
	290,000	48,000	13,70	NUP232	19	NTN			
	290,000	48,000	15,60	NUP232E	19	NTN			
	290,000	60,000	15,43	NH232	21	NTN			
	290,000	75,000	22,40	RN233	17	NTN			
	290,000	80,000	21,60	N2232	20	NTN			
	290,000	80,000	20,20	NJ2232	18	NTN			
	290,000	80,000	25,10	NJ2232E	18	NTN			
290,000	80,000	22,70	NU2232	17	NTN				
290,000	80,000	25,10	NU2232E	17	NTN				
290,000	80,000	22,00	NUP2232	19	NTN				
290,000	80,000	25,10	NUP2232E	19	NTN				
290,000	98,425	30,00	RNU3216	17	NTN				
300,000	70,000	24,00	2RT3215	36	NTN				
340,000	68,000	30,60	N332	20	NTN				
340,000	68,000	31,10	NF332	22	NTN				
340,000	68,000	31,30	NJ332	18	NTN				
340,000	68,000	34,00	NJ332E	18	NTN				
340,000	68,000	30,80	NU332	17	NTN				
340,000	68,000	34,00	NU332E	17	NTN				

d	D	B	Kg	Reference					Brands
160,000	340,000	68,000	31,30	NUP332	19	NTN			
	340,000	68,000	34,00	NUP332E	19	NTN			
	340,000	83,000	32,30	NH332	21	NTN			
	340,000	114,000	49,50	N2332	20	NTN			
	340,000	114,000	50,50	NJ2332	18	NTN			
	340,000	114,000	56,00	NJ2332E	18	NTN			
	340,000	114,000	50,40	NU2332	17	NTN			
	340,000	114,000	56,00	NU2332E	17	NTN			
	340,000	114,000	51,50	NU 2332 EM	17	SNR			
	340,000	114,000	50,50	NUP2332	19	NTN			
	340,000	114,000	56,00	NUP2332E	19	NTN			
	169,000	250,000	42,000	6,32	RUS228	23	NTN		
170,000	215,000	45,000	4,10	SL01-4834	26	NTN			
	215,000	45,000	3,79	SL02-4834	26	NTN			
	230,000	28,000	3,52	NU1934	17	NTN			
	230,000	36,000	4,53	NU2934	17	NTN			
	230,000	36,000	4,24	R3428V	17	NTN			
	230,000	60,000	7,19	SL01-4934	26	NTN			
	230,000	60,000	7,02	SL02-4934	26	NTN			
	230,000	120,000	14,20	4R3426	28	NTN			
	230,000	120,000	14,60	4R3443	28	NTN			
	240,000	156,000	22,20	4R3429	28	NTN			
	240,000	160,000	22,80	4R3423	28	NTN			
	250,000	168,000	28,50	4R3428	28	NTN			
	250,000	168,000	28,20	4R3432	28	NTN			
	255,000	180,000	19,30	4R3425	28	NTN			
	260,000	42,000	7,02	N1034	20	NTN			
	260,000	42,000	7,88	NJ1034	18	NTN			
	260,000	42,000	7,86	NU1034	17	NTN			
	260,000	42,000	7,88	NUP1034	19	NTN			
	260,000	122,000	23,10	SL04-5034LLNR	26	NTN			
	260,000	122,000	23,10	SL04-5034NR	26	NTN			
	260,000	150,000	29,50	4R3433	28	NTN			
	260,000	225,000	44,00	4R3431	28	NTN			
	280,000	88,000	29,60	SLX170X280X165	26	NTN			
	280,000	88,000	29,60	SLX170X280X88	26	NTN			
	280,000	95,000	24,80	SLX170X280X95	26	NTN			
	280,000	145,000	23,72	RNU3430	17	NTN			
	280,000	185,000	26,25	RNU3431	17	NTN			
	295,000	137,000	21,00	R3431K30	17	NTN			
	295,000	180,000	25,50	R3451K30	17	NTN			
	310,000	52,000	16,70	N234	20	NTN			
	310,000	52,000	17,20	NF234	22	NTN			
	310,000	52,000	17,30	NJ234	18	NTN			
	310,000	52,000	19,60	NJ234E	18	NTN			
	310,000	52,000	17,00	NU234	17	NTN			
	310,000	52,000	19,60	NU234E	17	NTN			
	310,000	52,000	17,96	NU 234 EM	17	SNR			
	310,000	52,000	17,00	NUP234	19	NTN			
	310,000	52,000	19,60	NUP234E	19	NTN			
	310,000	86,000	26,70	N2234	20	NTN			
	310,000	86,000	27,20	NJ2234	18	NTN			
	310,000	86,000	31,00	NJ2234E	18	NTN			
	310,000	86,000	27,60	NU2234	17	NTN			
310,000	86,000	31,00	NU2234E	17	NTN				
310,000	86,000	27,20	NUP2234	19	NTN				
310,000	86,000	31,00	NUP2234E	19	NTN				
310,000	104,770	36,00	RNU3415	17	NTN				
310,000	110,000	37,40	NU3234	17	NTN				
310,000	172,000	57,20	RNNU3421	24	NTN				

d	D	B	Kg	Reference					Brands	
170,000	360,000	72,000	36,10	N334	20	NTN				
	360,000	72,000	37,90	N 334 EM	20	SNR				
	360,000	72,000	31,30	NF334	22	NTN				
	360,000	72,000	37,30	NJ334	18	NTN				
	360,000	72,000	37,00	NU334	17	NTN				
	360,000	72,000	37,00	NUP334	19	NTN				
	360,000	120,000	58,70	E-NU2334BG1	17	NTN				
	360,000	120,000	70,80	E-NUP2334BG1	19	NTN				
	360,000	120,000	58,30	N2334	20	NTN				
	360,000	120,000	59,50	NJ2334	18	NTN				
	360,000	120,000	59,70	NU2334	17	NTN				
	360,000	120,000	59,50	NUP2334	19	NTN				
	177,800	260,350	63,500	10,99	RN629	17	NTN			
		260,350	63,500	10,99	RNU3629	17	NTN			
		320,000	193,000	64,19	RNU3653	17	NTN			
		355,600	114,300	43,00	2RT3627	36	NTN			
	395,350	88,900	62,00	2RT3623	36	NTN				
	395,351	130,000	60,00	2RT3629	36	NTN				
180,000	220,000	22,000	2,10	RT3615	36	NTN				
	225,000	45,000	4,08	SL01-4836	26	NTN				
	225,000	45,000	4,15	SL02-4836	26	NTN				
	240,000	76,000	8,94	2R3612	24	NTN				
	240,000	80,000	9,42	SLX180X240X80LL	26	NTN				
	250,000	33,000	5,21	NU1936	17	NTN				
	250,000	42,000	6,63	NU2936	17	NTN				
	250,000	69,000	10,70	SL01-4936	26	NTN				
	250,000	69,000	10,20	SL02-4936	26	NTN				
	250,000	138,000	20,40	SL02-4936D2	26	NTN				
	250,000	156,000	23,20	4R3625	28	NTN				
	250,000	156,000	24,00	4R3640	28	NTN				
	250,000	168,000	25,60	4R3639	28	NTN				
	252,000	110,000	16,20	RNN3611	24	NTN				
	260,000	168,000	26,90	4R3628	28	NTN				
	260,000	168,000	28,80	4R3642	28	NTN				
	260,000	168,000	33,00	4R3644	28	NTN				
	265,000	180,000	34,20	4R3618	28	NTN				
	265,000	180,000	34,30	4R3631	28	NTN				
	280,000	46,000	10,10	N1036	20	NTN				
	280,000	46,000	10,30	NJ1036	18	NTN				
	280,000	46,000	10,30	NU1036	17	NTN				
	280,000	46,000	10,30	NUP1036	19	NTN				
	280,000	74,000	16,80	NFV3036A	22	NTN				
	280,000	74,000	17,80	NU3036	17	NTN				
	280,000	74,000	15,90	R3624	17	NTN				
	280,000	136,000	32,30	SL04-5036LLNR	26	NTN				
	280,000	136,000	30,60	SL04-5036NR	26	NTN				
	310,000	115,000	30,30	SL07-040	26	NTN				
	310,000	120,000	34,90	2R3616V	24	NTN				
	320,000	52,000	17,30	N236	20	NTN				
	320,000	52,000	17,10	NF236	22	NTN				
320,000	52,000	18,00	NJ236	18	NTN					
320,000	52,000	20,40	NJ236E	18	NTN					
320,000	52,000	17,70	NU236	17	NTN					
320,000	52,000	20,40	NU236E	17	NTN					
320,000	52,000	19,13	NU 236 EM	17	SNR					
320,000	52,000	17,70	NUP236	19	NTN					
320,000	52,000	20,40	NUP236E	19	NTN					
320,000	86,000	27,80	N2236	20	NTN					
320,000	86,000	29,60	NJ2236	18	NTN					
320,000	86,000	31,90	NJ2236E	18	NTN					

										Brands	
d	D	B	Kg	Reference							
180,000	320,000	86,000	29,10	NU2236	17	NTN					
	320,000	86,000	31,90	NU2236E	17	NTN					
	320,000	86,000	28,40	NUP2236	19	NTN					
	320,000	86,000	31,90	NUP2236E	19	NTN					
	320,000	112,000	39,60	NU3236	17	NTN					
	320,000	126,000	31,70	RNU3658K	17	NTN					
	320,000	172,000	58,20	NU2236D2	17	NTN					
	340,000	55,000	24,70	2RT3632	36	NTN					
	380,000	75,000	42,74	N336	20	NTN					
	380,000	75,000	44,20	NJ336	18	NTN					
	380,000	75,000	42,30	NU336	17	NTN					
	380,000	75,000	44,20	NUP336	19	NTN					
	380,000	126,000	64,30	2R3618	24	NTN					
	380,000	126,000	68,10	N2336	20	NTN					
	380,000	126,000	61,00	NJ2336	18	NTN					
	380,000	126,000	69,50	NU2336	17	NTN					
	380,000	126,000	69,50	NUP2336	19	NTN					
	380,000	150,000	88,00	NU3336	17	NTN					
	406,400	171,040	132,00	3RCS3615	27	NTN					
	406,400	171,040	126,80	3RCS3621	27	NTN					
190,000	240,000	24,000	2,54	NFV1838	22	NTN					
	240,000	50,000	5,65	SL01-4838	26	NTN					
	240,000	50,000	5,14	SL02-4838	26	NTN					
	260,000	42,000	6,93	NU2938	17	NTN					
	260,000	42,000	6,55	R3819V	17	NTN					
	260,000	69,000	11,00	SL01-4938	26	NTN					
	260,000	69,000	10,90	SL02-4938	26	NTN					
	260,000	168,000	26,90	4R3820	28	NTN					
	270,000	170,000	31,70	4R3818	28	NTN					
	270,000	200,000	37,20	4R3817	28	NTN					
	270,000	200,000	37,50	4R3821	28	NTN					
	280,000	90,000	18,00	RN3813NA	17	NTN					
	280,000	200,000	41,50	4R3823	28	NTN					
	280,000	200,000	42,80	4R3830	28	NTN					
	290,000	46,000	10,50	N1038	20	NTN					
	290,000	46,000	10,70	NJ1038	18	NTN					
	290,000	46,000	10,70	NU1038	17	NTN					
	290,000	46,000	10,70	NUP1038	19	NTN					
	290,000	75,000	18,00	N3038	20	NTN					
	290,000	136,000	31,70	SL04-5038NR	26	NTN					
	300,000	85,725	24,10	RNU3840	17	NTN					
	300,000	85,725	21,40	RNU3842	17	NTN					
	320,000	75,000	26,40	2RT3814	36	NTN					
	340,000	55,000	21,13	N238	20	NTN					
	340,000	55,000	21,70	NF238	22	NTN					
	340,000	55,000	21,80	NJ238	18	NTN					
	340,000	55,000	24,20	NJ238E	18	NTN					
	340,000	55,000	21,30	NU238	17	NTN					
	340,000	55,000	24,20	NU238E	17	NTN					
	340,000	55,000	23,04	NU 238 EM	17	SNR					
	340,000	55,000	21,30	NUP238	19	NTN					
	340,000	55,000	24,20	NUP238E	19	NTN					
	340,000	92,000	33,70	N2238	20	NTN					
	340,000	92,000	34,40	NJ2238	18	NTN					
	340,000	92,000	39,50	NJ2238E	18	NTN					
	340,000	92,000	35,20	NU2238	17	NTN					
	340,000	92,000	39,50	NU2238E	17	NTN					
	340,000	92,000	34,40	NUP2238	19	NTN					
	340,000	92,000	39,50	NUP2238E	19	NTN					
	340,000	114,300	45,60	RNU3819	17	NTN					
340,000	120,000	48,20	NU3238	17	NTN						

										Brands		
d	D	B	Kg	Reference								
190,000	340,000	220,000	75,50	RNU3824	17	NTN						
	340,000	275,000	94,40	RNU3823	17	NTN						
	400,000	78,000	48,30	N338	20	NTN						
	400,000	78,000	50,50	N 338 EM	20	SNR						
	400,000	78,000	49,60	NF338	22	NTN						
	400,000	78,000	41,70	NJ338	18	NTN						
	400,000	78,000	49,40	NU338	17	NTN						
	400,000	78,000	49,40	NUP338	19	NTN						
	400,000	105,000	33,04	E-RNJ3849	18	NTN						
	400,000	132,000	78,90	N2338	20	NTN						
	400,000	132,000	80,50	NJ2338	18	NTN						
	400,000	132,000	80,72	NU2338	17	NTN						
	400,000	132,000	80,50	NUP2338	19	NTN						
	400,000	155,000	101,00	NU3338	17	NTN						
	190,500	340,000	190,500	56,90	RNU3820	17	NTN					
	200,000	250,000	50,000	5,58	SL01-4840	26	NTN					
		250,000	50,000	5,39	SL02-4840	26	NTN					
		270,000	170,000	28,50	4R4039	28	NTN					
		280,000	38,000	6,76	N1940K	20	NTN					
280,000		38,000	7,65	NU1940	17	NTN						
280,000		48,000	9,66	NU2940	17	NTN						
280,000		80,000	15,70	SL01-4940	26	NTN						
280,000		80,000	15,10	SL02-4940	26	NTN						
280,000		152,000	29,50	4R4054	28	NTN						
280,000		170,000	33,00	4R4048	28	NTN						
280,000		190,000	36,70	4R4026	28	NTN						
280,000		200,000	38,80	4R4027	28	NTN						
280,000		200,000	37,90	4R4037	28	NTN						
280,000		200,000	45,00	4R4050	28	NTN						
280,000		200,000	45,00	4R4052	28	NTN						
290,000		55,000	11,80	E-RNJ4022	18	NTN						
290,000		192,000	42,50	4R4041	28	NTN						
290,000		192,000	46,00	4R4043	28	NTN						
310,000		51,000	13,70	N1040	20	NTN						
310,000		51,000	13,33	N1040K	20	NTN						
310,000		51,000	13,90	NJ1040	18	NTN						
310,000		51,000	13,90	NU1040	17	NTN						
310,000		51,000	13,90	NUP1040	19	NTN						
310,000		82,000	24,10	NU3040	17	NTN						
310,000		109,000	32,30	R4046	17	NTN						
310,000		140,000	31,70	SL08-040	26	NTN						
310,000		150,000	41,80	SL04-5040NR	26	NTN						
320,000		48,000	46,16	RN4022	17	NTN						
320,000		216,000	67,00	4R4028	28	NTN						
340,000		75,000	30,80	2RT4028	36	NTN						
340,000		85,000	35,00	2RT4030	36	NTN						
340,000		112,000	42,80	NU3140A	17	NTN						
340,000		115,000	45,00	2R4031VK	24	NTN						
340,000		175,000	68,21	2R4029	24	NTN						
360,000		58,000	25,10	N240	20	NTN						
360,000		58,000	26,00	NJ240	18	NTN						
360,000		58,000	28,10	NJ240E	18	NTN						
360,000		58,000	25,50	NU240	17	NTN						
360,000	58,000	28,10	NU240E	17	NTN							
360,000	58,000	25,30	NUP240	19	NTN							
360,000	58,000	28,10	NUP240E	19	NTN							
360,000	98,000	40,50	N2240									

								Brands	
d	D	B	Kg	Reference					
200,000	360,000	98,000	42,50	NU2240E	17	NTN			
	360,000	98,000	41,30	NUP2240	19	NTN			
	360,000	98,000	47,80	NUP2240E	19	NTN			
	360,000	98,000	40,00	R4032K	17	NTN			
	360,000	104,000	42,90	RNU4046	17	NTN			
	360,000	128,000	58,00	NU3240	17	NTN			
	378,000	75,000	41,10	2RT4046	36	NTN			
	400,000	122,000	66,70	2RT4032	36	NTN			
	420,000	80,000	54,50	N340	20	NTN			
	420,000	80,000	57,00	N 340 EM	20	SNR			
	420,000	80,000	56,14	NF340	22	NTN			
	420,000	80,000	55,80	NJ340	18	NTN			
	420,000	80,000	55,02	NU340	17	NTN			
	420,000	80,000	55,80	NUP340	19	NTN			
	420,000	138,000	90,70	N2340	20	NTN			
	420,000	138,000	92,60	NJ2340	18	NTN			
	420,000	138,000	92,60	NU2340	17	NTN			
	420,000	138,000	92,60	NUP2340	19	NTN			
	420,000	140,000	82,50	RNU4036	17	NTN			
	420,000	160,000	109,60	2RN4024	24	NTN			
	420,000	165,000	118,10	NU3340	17	NTN			
	420,000	165,000	120,00	R4056	17	NTN			
	203,200	273,050	41,275	6,36	RNJ4103	18	NTN		
210,000	290,000	45,000	8,20	R4207	17	NTN			
	290,000	70,000	17,50	R4208	17	NTN			
	290,000	80,000	15,10	RNN4207K	24	NTN			
	290,000	192,000	39,50	4R4206	28	NTN			
	380,000	127,000	63,30	RNU4203	17	NTN			
215,900	355,600	79,375	29,80	RNU4302	17	NTN			
220,000	270,000	25,000	4,30	RT4411	36	NTN			
	270,000	50,000	6,40	SL01-4844	26	NTN			
	270,000	50,000	5,87	SL02-4844	26	NTN			
	290,000	192,000	33,80	4R4413	28	NTN			
	300,000	48,000	10,00	NFV2944	22	NTN			
	300,000	48,000	10,50	NU2944	17	NTN			
	300,000	48,000	9,84	R4416V	17	NTN			
	300,000	80,000	16,80	SL01-4944	26	NTN			
	300,000	80,000	16,40	SL02-4944	26	NTN			
	300,000	160,000	32,80	4R4419	28	NTN			
	300,000	160,000	33,70	4R4445	28	NTN			
	300,000	160,000	41,00	4R4446	28	NTN			
	310,000	110,000	29,70	RNN4411	24	NTN			
	310,000	110,000	29,50	RNN4411K	24	NTN			
	310,000	192,000	46,30	4R4410	28	NTN			
	310,000	192,000	46,90	4R4426	28	NTN			
	310,000	192,000	45,90	4R4432	28	NTN			
	310,000	192,000	44,50	4R4448	28	NTN			
	310,000	204,000	49,80	4R4425	28	NTN			
	310,000	215,000	51,50	4R4420	28	NTN			
	310,000	225,000	54,90	4R4416	28	NTN			
	310,000	225,000	62,00	4R4440	28	NTN			
	310,000	225,000	54,30	4R4449	28	NTN			
	310,000	265,000	63,50	4R4430	28	NTN			
	320,000	160,000	46,50	4R4428	28	NTN			
	320,000	210,000	60,50	4R4429	28	NTN			
	320,000	210,000	55,40	4R4444	28	NTN			
	340,000	56,000	18,10	N1044	20	NTN			
	340,000	56,000	17,90	N1044K	20	NTN			

								Brands	
d	D	B	Kg	Reference					
220,000	340,000	56,000	18,20	NJ1044	18	NTN			
	340,000	56,000	18,30	NU1044	17	NTN			
	340,000	56,000	18,20	NUP1044	19	NTN			
	340,000	90,000	31,70	NU3044	17	NTN			
	340,000	142,000	42,60	2RNU4412	24	NTN			
	340,000	160,000	53,80	SL04-5044LLNR	26	NTN			
	340,000	160,000	55,40	SL04-5044NR	26	NTN			
	350,000	98,425	37,00	RNU4424	17	NTN			
	360,000	85,000	32,60	2RT4416	36	NTN			
	370,000	120,000	53,30	NU3144	17	NTN			
	370,000	120,000	65,40	SLX220X370X200	26	NTN			
	370,000	125,000	63,00	2R4413V	24	NTN			
	370,000	125,000	59,05	SLX220X370X125	26	NTN			
	370,000	195,000	67,50	2R4414V	24	NTN			
	400,000	65,000	36,50	N244	20	NTN			
	400,000	65,000	37,46	NJ244	18	NTN			
	400,000	65,000	37,70	NU244	17	NTN			
	400,000	65,000	37,70	NUP244	19	NTN			
	400,000	108,000	57,80	N2244	20	NTN			
	400,000	108,000	59,00	NJ2244	18	NTN			
	400,000	108,000	59,00	NU2244	17	NTN			
	400,000	108,000	59,00	NUP2244	19	NTN			
	400,000	133,350	64,30	RNU4423	17	NTN			
	400,000	144,000	84,20	NU3244	17	NTN			
	440,000	200,000	145,60	2RNU4413	24	NTN			
	460,000	88,000	71,70	N344	20	NTN			
	460,000	88,000	74,00	NJ344	18	NTN			
	460,000	88,000	73,40	NU344	17	NTN			
	460,000	88,000	73,40	NUP344	19	NTN			
	460,000	108,000	81,10	NH344	21	NTN			
	460,000	145,000	114,00	N2344	20	NTN			
460,000	145,000	116,00	NJ2344	18	NTN				
460,000	145,000	116,00	NU2344	17	NTN				
460,000	145,000	116,00	NUP2344	19	NTN				
460,000	176,000	159,00	RNN4410	24	NTN				
460,000	180,000	154,00	RNN4421	24	NTN				
222,250	520,700	165,000	202,00	2RT4427	36	NTN			
	520,760	114,300	123,50	2RT4426	36	NTN			
230,000	330,000	206,000	64,00	4R4610	28	NTN			
	330,000	206,000	58,60	4R4614	28	NTN			
	330,000	206,000	64,00	4R4620	28	NTN			
	340,000	260,000	82,60	4R4611	28	NTN			
	340,000	260,000	74,30	4R4617	28	NTN			
	400,000	108,000	57,10	RNU4614	17	NTN			
	234,950	327,025	114,300	27,79	RNU4702	17	NTN		
235,000	376,000	250,000	100,80	E-2R4703	24	NTN			
240,000	300,000	28,000	4,49	NFV1848	22	NTN			
	300,000	60,000	9,61	SL01-4848	26	NTN			
	300,000	60,000	9,42	SL02-4848	26	NTN			
	320,000	48,000	9,44	N2948	20	NTN			
	320,000	48,000	11,30	NU2948	17	NTN			
	320,000	48,000	10,40	R4808V	17	NTN			
	320,000	80,000	18,40	SL01-4948	26	NTN			
	320,000	80,000	17,90	SL02-4948	26	NTN			
	330,000	180,000	46,40	4R4827	28	NTN			
	330,000	220,000	57,10	4R4804	28	NTN			
	330,000	220,000	56,10	4R4811	28	NTN			

								Brands		
d	D	B	Kg	Reference						
240,000	330,000	220,000	69,60	4R4818	28	NTN				
	330,000	220,000	54,10	4R4819	28	NTN				
	330,000	220,000	57,10	4R4821	28	NTN				
	340,000	220,000	63,22	4R4806	28	NTN				
	360,000	56,000	19,50	N1048	20	NTN				
	360,000	56,000	19,60	NJ1048	18	NTN				
	360,000	56,000	19,60	NU1048	17	NTN				
	360,000	56,000	19,60	NUP1048	19	NTN				
	360,000	92,000	34,70	NU3048	17	NTN				
	360,000	160,000	57,80	SL04-5048NR	26	NTN				
	360,000	220,000	79,60	4R4807	28	NTN				
	360,000	220,000	80,10	4R4813	28	NTN				
	390,000	130,000	65,70	SLX240X390X130	26	NTN				
	390,000	200,000	71,40	SLX240X390X200	26	NTN				
	440,000	72,000	49,20	N248	20	NTN				
	440,000	72,000	50,80	NJ248	18	NTN				
	440,000	72,000	49,90	NU248	17	NTN				
	440,000	72,000	50,20	NUP248	19	NTN				
	440,000	120,000	78,40	N2248	20	NTN				
	440,000	120,000	80,00	NJ2248	18	NTN				
	440,000	120,000	81,50	NU2248	17	NTN				
	440,000	120,000	80,00	NUP2248	19	NTN				
	440,000	146,000	101,00	RNU4817	17	NTN				
	440,000	146,050	93,32	RNU4804	17	NTN				
	500,000	95,000	91,30	N348	20	NTN				
	500,000	95,000	93,40	NJ348	18	NTN				
	500,000	95,000	92,70	NU348	17	NTN				
	500,000	95,000	93,40	NUP348	19	NTN				
	500,000	155,000	144,00	N2348	20	NTN				
	500,000	155,000	147,00	NJ2348	18	NTN				
	500,000	155,000	147,00	NU2348	17	NTN				
	500,000	155,000	147,00	NUP2348	19	NTN				
	500,000	157,000	130,00	RNU4807	17	NTN				
	500,000	250,000	219,00	RNN4805	24	NTN				
	250,000	278,000	220,000	19,60	4R5008	28	NTN			
		400,000	263,000	126,80	E-2R5005	24	NTN			
	254,000	420,010	76,200	44,10	2RT5106	36	NTN			
	260,000	320,000	60,000	11,00	SL01-4852	26	NTN			
		320,000	60,000	10,10	SL02-4852	26	NTN			
320,000		145,000	49,60	RNNU5218	24	NTN				
360,000		46,000	14,10	N1952K	20	NTN				
360,000		46,000	14,18	NF1952	22	NTN				
360,000		46,000	14,90	NU1952	17	NTN				
360,000		60,000	19,50	NU2952	17	NTN				
360,000		60,000	18,70	R5213V	17	NTN				
360,000		100,000	32,00	SL01-4952	26	NTN				
360,000		100,000	30,70	SL02-4952	26	NTN				
360,000		220,000	62,70	4R5221	28	NTN				
360,000		230,000	70,10	4R5236	28	NTN				
360,000		260,000	81,50	4R5231	28	NTN				
370,000		85,000	31,90	2RT5202	36	NTN				
370,000		220,000	77,10	4R5208	28	NTN				
370,000		220,000	76,50	4R5217	28	NTN				
380,000		280,000	109,00	4R5213	28	NTN				
380,000		280,000	98,00	4R5224	28	NTN				
400,000		65,000	28,70	N1052	20	NTN				
400,000		65,000	29,10	NJ1052	18	NTN				
400,000		65,000	29,30	NU1052	17	NTN				
400,000		65,000	29,10	NUP1052	19	NTN				

								Brands		
d	D	B	Kg	Reference						
260,000	400,000	104,000	50,40	NU3052	17	NTN				
	400,000	110,000	46,60	RNN5208K	24	NTN				
	400,000	190,000	89,36	SL04-5052N	26	NTN				
	400,000	190,000	89,36	SL04-5052NR	26	NTN				
	400,000	290,000	135,00	4R5218	28	NTN				
	420,000	216,000	122,90	2R5215	24	NTN				
	440,000	144,000	95,10	NU3152	17	NTN				
	440,000	145,000	87,70	SLX260X440X145	26	NTN				
	480,000	80,000	65,60	N252	20	NTN				
	480,000	80,000	56,30	NJ252	18	NTN				
	480,000	80,000	66,40	NU252	17	NTN				
	480,000	80,000	66,90	NUP252	19	NTN				
	480,000	130,000	102,00	N2252	20	NTN				
	480,000	130,000	104,00	NJ2252	18	NTN				
	480,000	130,000	109,88	NU2252	17	NTN				
	480,000	130,000	104,00	NUP2252	19	NTN				
	480,000	150,000	105,00	RNU5214	17	NTN				
	480,000	158,800	131,00	RNU5215	17	NTN				
	480,000	158,800	135,00	RNU5216	17	NTN				
	480,000	200,000	109,60	2RN52102	24	NTN				
	480,000	260,000	212,90	2RN5212	24	NTN				
	540,000	102,000	114,00	N352	20	NTN				
	540,000	102,000	117,00	NJ352	18	NTN				
	540,000	102,000	117,00	NU352	17	NTN				
	540,000	102,000	117,00	NUP352	19	NTN				
	540,000	165,000	178,00	N2352	20	NTN				
	540,000	165,000	182,00	NJ2352	18	NTN				
	540,000	165,000	182,00	NU2352	17	NTN				
	540,000	165,000	182,00	NUP2352	19	NTN				
	540,000	167,000	162,00	RNU5209	17	NTN				
	540,000	206,000	242,00	NU3352	17	NTN				
	540,000	230,000	235,00	RNNU5217	24	NTN				
	540,000	300,000	306,00	2RN5213	24	NTN				
	540,000	382,000	421,00	RNNJ5208DF	24	NTN				
	260,500	480,000	260,000	234,00	2RN5214	24	NTN			
	265,000	370,000	234,000	78,90	4R5306	28	NTN			
	266,700	406,400	139,700	67,30	RNU5311	17	NTN			
270,000	380,000	280,000	100,00	4R5405	28	NTN				
	380,000	280,000	101,00	4R5407	28	NTN				
273,000	510,000	300,000	278,00	RNNU5503	24	NTN				
277,000	385,000	65,000	22,90	R5501	17	NTN				
280,000	350,000	69,000	15,40	SL01-4856	26	NTN				
	350,000	69,000	15,00	SL02-4856	26	NTN				
	350,000	138,000	31,20	SL02-4856D2	26	NTN				
	350,000	208,000	46,40	4R5614	28	NTN				
	380,000	46,000	14,55	F-NU1956	17	NTN				
	380,000	46,000	14,86	NU1956	17	NTN				
	380,000	60,000	20,00	NFV2956	22	NTN				
	380,000	60,000	20,80	NU2956	17	NTN				
	380,000	60,000	17,10	R5608V	17	NTN				
	380,000	75,000	25,60	NU3956	17	NTN				
	380,000	100,000	33,90	SL01-4956	26	NTN				
	380,000	100,000	33,10	SL02-4956	26	NTN				
	390,000	220,000	95,00	4R5604	28	NTN				
	390,000	220,000	80,80	4R5610	28	NTN				

										Brands		
d	D	B	Kg	Reference								
280,000	390,000	220,000	81,30	4R5611	28	NTN						
	390,000	275,000	105,00	4R5612	28	NTN						
	400,000	150,000	59,40	RNNU5609	24	NTN						
	420,000	65,000	30,40	N1056	20	NTN						
	420,000	65,000	30,90	NJ1056	18	NTN						
	420,000	65,000	30,90	NU1056	17	NTN						
	420,000	65,000	30,90	NUP1056	19	NTN						
	420,000	106,000	54,40	NU3056	17	NTN						
	420,000	190,000	93,90	SL04-5056N	26	NTN						
	420,000	190,000	93,90	SL04-5056NR	26	NTN						
	420,000	235,000	95,00	2R5613V	24	NTN						
	420,000	280,000	139,00	4R5605	28	NTN						
	450,000	320,000	149,00	E-2R5614	24	NTN						
	460,000	123,800	84,00	RN5609	17	NTN						
	460,000	200,000	127,80	SLX280X460X200	26	NTN						
	460,000	260,000	166,30	SLX280X460X260	26	NTN						
	500,000	80,000	69,40	N256	20	NTN						
	500,000	80,000	70,80	NJ256	18	NTN						
	500,000	80,000	70,80	NU256	17	NTN						
	500,000	80,000	70,80	NUP256	19	NTN						
	500,000	130,000	107,00	N2256	20	NTN						
	500,000	130,000	109,00	NJ2256	18	NTN						
	500,000	130,000	109,00	NU2256	17	NTN						
	500,000	130,000	109,00	NUP2256	19	NTN						
	500,000	165,100	150,00	RNU5617	17	NTN						
	500,000	165,100	148,00	RNU5619	17	NTN						
	500,000	165,100	146,00	RNU5623	17	NTN						
	560,000	300,000	354,80	RNN5610	24	NTN						
	580,000	108,000	139,00	N356	20	NTN						
	580,000	108,000	142,00	NJ356	18	NTN						
	580,000	108,000	142,00	NU356	17	NTN						
	580,000	108,000	142,00	NUP356	19	NTN						
	580,000	175,000	218,00	N2356	20	NTN						
	580,000	175,000	222,00	NJ2356	18	NTN						
	580,000	175,000	222,00	NU2356	17	NTN						
	580,000	175,000	222,00	NUP2356	19	NTN						
	285,000	460,000	190,000	193,00	SLX285X460X190	26	NTN					
		460,000	260,000	133,00	SLX285X460X260	26	NTN					
	290,000	390,000	234,000	101,00	4R5810	28	NTN					
		410,000	240,000	103,00	4R5806	28	NTN					
420,000		120,000	60,00	RTD5803	36	NTN						
420,000		300,000	141,00	4R5805	28	NTN						
510,000		260,000	233,00	RNNU5804	24	NTN						
292,100	387,350	50,800	15,50	RNU5804	17	NTN						
	387,350	66,670	18,60	RN5804	17	NTN						
	387,350	66,670	18,60	RN58042	17	NTN						
300,000	380,000	60,000	17,10	NU3860	17	NTN						
	380,000	80,000	23,00	SL01-4860	26	NTN						
	380,000	80,000	21,30	SL02-4860	26	NTN						
	400,000	300,000	104,00	4R6014	28	NTN						
	400,000	300,000	104,00	E-4R6014	28	NTN						
	410,000	143,000	55,00	2R6015	24	NTN						
	420,000	56,000	25,40	NU1960	17	NTN						
	420,000	72,000	32,60	NU2960	17	NTN						
	420,000	118,000	53,00	SL01-4960	26	NTN						
	420,000	118,000	51,90	SL02-4960	26	NTN						
	420,000	240,000	103,10	4R6012	28	NTN						
	420,000	240,000	94,50	4R6017	28	NTN						

										Brands		
d	D	B	Kg	Reference								
300,000	420,000	240,000	105,00	4R6023	28	NTN						
	420,000	240,000	117,00	4R6025	28	NTN						
	420,000	240,000	105,00	4R6027	28	NTN						
	420,000	240,000	106,00	E-4R6017	28	NTN						
	420,000	300,000	125,00	4R6015	28	NTN						
	420,000	300,000	130,00	4R6020	28	NTN						
	420,000	300,000	136,00	4R6030	28	NTN						
	420,000	300,000	129,00	4R6040	28	NTN						
	420,000	300,000	125,00	E-4R6015	28	NTN						
	420,000	300,000	130,00	E-4R6020	28	NTN						
	420,000	320,000	136,00	4R6018	28	NTN						
	420,000	320,000	136,00	E-4R6018	28	NTN						
	430,000	165,000	76,30	RNN6011	24	NTN						
	430,000	240,000	115,00	4R6021	28	NTN						
	460,000	74,000	42,90	N1060	20	NTN						
	460,000	74,000	43,60	NJ1060	18	NTN						
	460,000	74,000	43,50	NU1060	17	NTN						
	460,000	74,000	43,60	NUP1060	19	NTN						
	460,000	118,000	65,40	2R6010	24	NTN						
	460,000	118,000	75,20	NU3060	17	NTN						
	460,000	218,000	137,00	SL04-5060NR	26	NTN						
	460,000	270,000	162,00	4R6019	28	NTN						
	460,000	270,000	162,00	E-4R6019	28	NTN						
	466,000	370,000	221,10	E-2R6018	24	NTN						
	480,000	170,000	125,00	SLX300X480X170	26	NTN						
	540,000	85,000	86,40	N260	20	NTN						
	540,000	85,000	88,20	NJ260	18	NTN						
	540,000	85,000	88,20	NU260	17	NTN						
	540,000	85,000	88,20	NUP260	19	NTN						
	540,000	140,000	135,00	N2260	20	NTN						
	540,000	140,000	138,00	NJ2260	18	NTN						
	540,000	140,000	138,00	NU2260	17	NTN						
	540,000	140,000	138,00	NUP2260	19	NTN						
	540,000	145,000	157,00	2RT6016	36	NTN						
	540,000	177,800	182,00	RNU6028	17	NTN						
	540,000	192,000	193,00	NU3260	17	NTN						
	540,000	350,000	360,00	RNNJ6001DF	24	NTN						
	620,000	185,000	316,00	NU2360	17	NTN						
	310,000	430,000	240,000	108,00	4R6202	28	NTN					
		430,000	240,000	108,00	E-4R6202	28	NTN					
320,000	380,000	30,000	8,40	RT6405	36	NTN						
	400,000	60,000	18,10	NU3864	17	NTN						
	400,000	80,000	23,00	SL01-4864	26	NTN						
	400,000	80,000	23,50	SL02-4864	26	NTN						
	440,000	56,000	26,80	NU1964	17	NTN						
	440,000	72,000	28,40	R6410V	17	NTN						
	440,000	90,000	42,20	NU3964	17	NTN						
	440,000	118,000	56,00	SL01-4964	26	NTN						
	440,000	118,000	54,90	SL02-4964	26	NTN						
	440,000	236,000	110,00	SL02-496402	26	NTN						
	440,000	240,000	106,00	4R6414	28	NTN						
	440,000	240,000	106,00	E-4R6414	28	NTN						
	450,000	240,000	125,00	4R6411	28	NTN						
	450,000	240,000	125,00	E-4R6411	28	NTN						
	460,000	340,000	178,00	4R6412	28	NTN						
	460,000	340,000	178,00	E-4R6412	28	NTN						
	470,000	350,000	212,00	4R6406	28	NTN						
	470,000	350,000	212,00	E-4R6406	28	NTN						
480,000	74,000	45,30	N1064	20	NTN							
480,000	74,000	46,00	NJ1064	18	NTN							

								Brands		
d	D	B	Kg	Reference						
320,000	480,000	74,000	46,00	NU1064	17	NTN				
	480,000	74,000	46,00	NUP1064	19	NTN				
	480,000	121,000	81,20	NU3064	17	NTN				
	480,000	175,000	110,00	RNNU6414	24	NTN				
	480,000	218,000	144,00	SL04-5064NR	26	NTN				
	500,000	71,000	53,70	RNF6404	22	NTN				
	520,000	176,000	128,00	RN6407	17	NTN				
	540,000	176,000	175,00	NU3164	17	NTN				
	580,000	92,000	109,00	N264	20	NTN				
	580,000	92,000	111,00	NJ264	18	NTN				
	580,000	92,000	111,00	NU264	17	NTN				
	580,000	92,000	111,00	NUP264	19	NTN				
	580,000	150,000	168,00	N2264	20	NTN				
	580,000	150,000	172,00	NJ2264	18	NTN				
	580,000	150,000	172,00	NU2264	17	NTN				
	580,000	150,000	172,00	NUP2264	19	NTN				
	580,000	160,000	196,00	RNU6411	17	NTN				
	580,000	160,000	196,00	RNU6416	17	NTN				
	580,000	160,000	192,00	RNU6424	17	NTN				
	580,000	190,500	210,00	RNU6422	17	NTN				
	622,300	268,000	330,00	RE6405	17	NTN				
	670,000	200,000	402,00	NU2364	17	NTN				
	670,000	202,000	302,00	RNU6407	17	NTN				
	323,850	444,500	85,725	40,70	RN6502	17	NTN			
	330,000	440,000	200,000	83,60	4R6603	28	NTN			
		440,000	200,000	85,60	4R6608	28	NTN			
		440,000	200,000	83,60	E-4R6603	28	NTN			
		460,000	340,000	177,00	4R6602	28	NTN			
		460,000	340,000	181,00	4R6605	28	NTN			
		460,000	340,000	181,00	E-4R6605	28	NTN			
340,000	420,000	80,000	25,60	SL01-4868	26	NTN				
	420,000	80,000	24,80	SL02-4868	26	NTN				
	440,000	143,000	49,60	E-2R6805	24	NTN				
	460,000	56,000	28,20	NU1968	17	NTN				
	460,000	72,000	33,90	NU2968	17	NTN				
	460,000	118,000	57,60	SL01-4968	26	NTN				
	460,000	118,000	57,80	SL02-4968	26	NTN				
	480,000	350,000	211,00	4R6819	28	NTN				
	480,000	370,000	198,00	4R6811	28	NTN				
	480,000	370,000	198,00	E-4R6811	28	NTN				
	490,000	300,000	187,00	4R6804	28	NTN				
	490,000	300,000	189,00	4R6805	28	NTN				
	490,000	300,000	187,00	E-4R6804	28	NTN				
	520,000	82,000	60,50	N1068	20	NTN				
	520,000	82,000	61,80	NJ1068	18	NTN				
	520,000	82,000	61,80	NU1068	17	NTN				
	520,000	82,000	61,80	NUP1068	19	NTN				
	520,000	133,000	108,00	NU3068	17	NTN				
	520,000	243,000	190,00	SL04-5068	26	NTN				
	520,000	243,000	194,00	SL04-5068NR	26	NTN				
	580,000	190,000	204,00	NU3168	17	NTN				
	590,000	210,000	235,00	RNU6808	17	NTN				
	600,000	170,000	225,00	RNU6805	17	NTN				
	620,000	165,000	260,00	NU2268	17	NTN				
	620,000	224,000	316,00	N268	20	NTN				
	620,000	224,000	316,00	NU3268	17	NTN				
	710,000	118,000	246,00	NU368	17	NTN				
	710,000	212,000	477,00	NU2368	17	NTN				

								Brands		
d	D	B	Kg	Reference						
342,900	457,200	57,150	27,40	RNJ6901	18	NTN				
350,000	600,000	190,000	240,00	SLX350X600X190	26	NTN				
	600,000	280,000	270,00	SLX350X600X280	26	NTN				
354,600	550,000	400,000	355,00	4R7108	28	NTN				
355,600	495,300	208,000	90,00	R71055	17	NTN				
356,760	550,000	400,000	354,00	4R7105K	28	NTN				
359,845	540,000	180,000	146,50	E-RNU7204	17	NTN				
360,000	440,000	38,000	11,90	NU1872	17	NTN				
	440,000	60,000	20,10	NU3872	17	NTN				
	440,000	80,000	27,00	SL01-4872	26	NTN				
	440,000	80,000	26,00	SL02-4872	26	NTN				
	480,000	56,000	29,60	NU1972	17	NTN				
	480,000	72,000	38,00	NU2972	17	NTN				
	480,000	118,000	62,00	SL01-4972	26	NTN				
	480,000	118,000	60,80	SL02-4972	26	NTN				
	480,000	290,000	148,00	4R7207	28	NTN				
	480,000	290,000	148,00	4R7214	28	NTN				
	500,000	125,000	81,00	RNNU7205	24	NTN				
	500,000	250,000	146,00	4R7219	28	NTN				
	510,000	370,000	244,00	4R7212	28	NTN				
	510,000	400,000	262,00	4R7203	28	NTN				
	510,000	400,000	251,00	4R7205	28	NTN				
	510,000	400,000	262,00	E-4R7203	28	NTN				
	540,000	82,000	63,70	N1072	20	NTN				
	540,000	82,000	64,70	NJ1072	18	NTN				
	540,000	82,000	64,70	NU1072	17	NTN				
	540,000	82,000	64,70	NUP1072	19	NTN				
	540,000	134,000	114,00	NU3072	17	NTN				
	540,000	243,000	203,00	SL04-5072NR	26	NTN				
600,000	192,000	232,00	NU3172A	17	NTN					
610,000	210,000	250,00	RNU7205	17	NTN					
650,000	170,000	250,00	NU2272	17	NTN					
650,000	170,000	245,00	R7207	17	NTN					
650,000	172,000	218,00	RNU7203	17	NTN					
650,000	232,000	369,00	N272	20	NTN					
650,000	232,000	356,00	NU3272	17	NTN					
750,000	224,000	562,00	NU2372	17	NTN					
370,000	480,000	230,000	106,00	4R7405	28	NTN				
	480,000	230,000	106,00	E-4R7405	28	NTN				
	480,000	250,000	118,00	4R7408	28	NTN				
	520,000	380,000	256,00	4R7411	28	NTN				
	520,000	400,000	273,00	4R7404	28	NTN				
	520,000	400,000	273,00	E-4R7404	28	NTN				
	550,000	400,000	341,00	4R7414	28	NTN				
380,000	480,000	100,000	45,30	SL01-4876	26	NTN				
	480,000	100,000	44,00	SL02-4876	26	NTN				
	520,000	65,000	42,90	NU1976	17	NTN				
	520,000	82,000	55,00	NF2976	22	NTN				
	520,000	82,000	54,10	NU2976	17	NTN				
	520,000	140,000	92,30	SL01-4976	26	NTN				
	520,000	140,000	90,50	SL02-4976	26	NTN				
	520,000	190,000	110,00	SLX380X520X190	26	NTN				
	520,000	280,000	174,00	4R7605	28	NTN				
	520,000	280,000	174,00	E-4R7605	28	NTN				

										Brands		
d	D	B	Kg	Reference								
380,000	520,000	290,000	185,00	4R7617	28	NTN						
	520,000	300,000	210,00	4R7607	28	NTN						
	520,000	300,000	210,00	E-4R7607	28	NTN						
	540,000	400,000	325,00	4R7604	28	NTN						
	540,000	400,000	300,00	4R7612	28	NTN						
	540,000	400,000	298,00	4R7613	28	NTN						
	540,000	400,000	309,00	4R7618	28	NTN						
	540,000	400,000	325,00	E-4R7604	28	NTN						
	560,000	82,000	66,10	N1076	20	NTN						
	560,000	82,000	67,50	NJ1076	18	NTN						
	560,000	82,000	67,50	NU1076	17	NTN						
	560,000	82,000	67,50	NUP1076	19	NTN						
	560,000	135,000	120,00	NU3076	17	NTN						
	560,000	243,000	212,00	SL04-5076NR	26	NTN						
	570,000	135,000	111,00	2R7603	24	NTN						
	620,000	200,000	268,00	SLX380X620X200	26	NTN						
	620,000	280,000	280,00	SLX380X620X280	26	NTN						
	657,000	410,000	600,00	E-2R7615	24	NTN						
	680,000	175,000	326,00	NU2276	17	NTN						
	680,000	177,000	295,00	RNU7611	17	NTN						
	680,000	240,000	348,00	2RNU7605	24	NTN						
	680,000	240,000	355,00	2RNU7606	24	NTN						
	680,000	240,000	400,00	N276	20	NTN						
	680,000	240,000	400,00	NU3276	17	NTN						
	400,000	500,000	46,000	19,20	RN8005	17	NTN					
		500,000	75,000	35,40	NU3880	17	NTN					
		540,000	112,000	79,70	RT8010	36	NTN					
		540,000	140,000	96,40	SL01-4980	26	NTN					
		540,000	140,000	94,60	SL02-4980	26	NTN					
		560,000	400,000	303,00	4R8007	28	NTN					
		560,000	400,000	303,00	E-4R8007	28	NTN					
		560,000	410,000	349,00	4R8010	28	NTN					
		560,000	410,000	349,00	E-4R8010	28	NTN					
		570,000	250,000	214,00	E-RNNU8013	24	NTN					
		590,000	420,000	399,00	4R8011	28	NTN					
600,000		90,000	87,60	F-NU1080	17	NTN						
600,000		90,000	86,30	N1080	20	NTN						
600,000		90,000	87,60	NJ1080	18	NTN						
600,000		90,000	87,60	NU1080	17	NTN						
600,000		90,000	87,60	NUP1080	19	NTN						
600,000		148,000	155,00	NU3080	17	NTN						
600,000		272,000	281,00	SL04-5080NR	26	NTN						
655,000		285,000	396,00	RNNU8016	24	NTN						
720,000		187,000	290,00	RNU8005	17	NTN						
720,000		256,000	451,00	NU3280	17	NTN						
405,000		730,000	195,000	335,00	RNU8102	17	NTN					
410,000	546,000	400,000	256,00	E-4R8201	28	NTN						
420,000	520,000	46,000	20,90	NFV1884	22	NTN						
	560,000	65,000	44,00	N1984K	20	NTN						
	560,000	65,000	46,70	NU1984	17	NTN						
	560,000	82,000	59,00	NU2984	17	NTN						
	560,000	140,000	101,00	SL01-4984	26	NTN						
	560,000	140,000	98,60	SL02-4984	26	NTN						
	560,000	280,000	189,00	4R8403	28	NTN						
	560,000	280,000	189,00	E-4R8403	28	NTN						
	580,000	230,000	181,00	4R8404	28	NTN						
	580,000	230,000	181,00	E-4R8404	28	NTN						
	600,000	440,000	423,00	4R8407	28	NTN						

										Brands		
d	D	B	Kg	Reference								
420,000	620,000	90,000	89,60	N1084	20	NTN						
	620,000	90,000	91,00	NJ1084	18	NTN						
	620,000	90,000	91,00	NU1084	17	NTN						
	620,000	90,000	91,00	NUP1084	19	NTN						
	620,000	272,000	292,00	SL04-5084NR	26	NTN						
	620,000	400,000	410,00	4R8401	28	NTN						
	620,000	400,000	410,00	E-4R8401	28	NTN						
	700,000	224,000	340,00	NU3184	17	NTN						
	700,000	280,000	440,70	2RNU8404	24	NTN						
	730,000	230,000	460,00	2RNU8403	24	NTN						
	740,000	320,000	565,00	2RE8404	24	NTN						
	760,000	272,000	548,00	NU3284	17	NTN						
	760,000	280,000	558,00	RNNU8413	24	NTN						
	430,000	591,000	420,000	362,00	4R8605	28	NTN					
	432,000	610,000	102,000	102,00	2RT8608	36	NTN					
	440,000	540,000	45,000	39,00	2RT8807	36	NTN					
		540,000	46,000	22,20	NFV1888	22	NTN					
		600,000	95,000	82,80	NF2988	22	NTN					
600,000		95,000	82,00	NU2988	17	NTN						
600,000		160,000	139,00	SL01-4988	26	NTN						
600,000		160,000	137,00	SL02-4988	26	NTN						
600,000		450,000	392,00	4R8805	28	NTN						
600,000		450,000	392,00	4R8806	28	NTN						
620,000		450,000	437,00	4R8801	28	NTN						
620,000		450,000	450,00	4R8803	28	NTN						
620,000		450,000	437,00	E-4R8801	28	NTN						
650,000		94,000	103,00	N1088	20	NTN						
650,000		94,000	105,00	NJ1088	18	NTN						
650,000		94,000	105,00	NU1088	17	NTN						
650,000		94,000	105,00	NUP1088	19	NTN						
650,000	157,000	188,00	NU3088	17	NTN							
650,000	280,000	331,00	SL04-5088NR	26	NTN							
670,000	160,000	186,00	2RT18801	36	NTN							
780,000	280,000	630,00	2RNU8802	24	NTN							
780,000	280,000	630,00	2RNU8804	24	NTN							
450,000	680,000	190,000	272,00	2RT19004V	36	NTN						
	680,000	280,000	284,00	2RT19005V	36	NTN						
457,000	660,000	102,000	105,00	2RT9101	36	NTN						
457,200	660,400	228,600	236,00	RNNU9103	24	NTN						
460,000	580,000	56,000	34,90	NFV1892	22	NTN						
	580,000	72,000	47,10	NU2892	17	NTN						
	620,000	74,000	65,20	E-NU1992	17	NTN						
	620,000	400,000	341,00	4R9209	28	NTN						
	620,000	400,000	383,00	4R9211	28	NTN						
	620,000	400,000	341,00	E-4R9209	28	NTN						
	620,000	460,000	417,00	4R9223	28	NTN						
	650,000	470,000	540,00	4R9216	28	NTN						
	650,000	470,000	540,00	E-4R9216	28	NTN						
	680,000	100,000	120,00	N1092	20	NTN						
	680,000	100,000	122,00	NJ1092	18	NTN						
	680,000	100,000	122,00	NU1092	17	NTN						
	680,000	100,000	122,00	NUP1092	19	NTN						
	710,000	150,000	240,00	2RT9202	36	NTN						

								Brands		
d	D	B	Kg	Reference						
470,000	660,000	470,000	529,00	4R9403	28	NTN				
	810,000	300,000	680,00	2RNU9406	24	NTN				
	870,000	210,000	563,00	RNU9403	17	NTN				
	890,000	325,000	945,00	2RNU9404	24	NTN				
480,000	600,000	236,000	155,00	4R9610	28	NTN				
	650,000	78,000	78,16	NF1996	22	NTN				
	650,000	78,000	73,10	NU1996	17	NTN				
	650,000	78,000	64,70	R9605	17	NTN				
	650,000	100,000	101,00	NU2996	17	NTN				
	650,000	420,000	369,00	4R9607	28	NTN				
	650,000	420,000	423,00	4R9613	28	NTN				
	650,000	420,000	369,00	E-4R9607	28	NTN				
	650,000	450,000	395,00	E-4R9609	28	NTN				
	680,000	250,000	295,00	RNNU9606	24	NTN				
	680,000	500,000	640,00	4R9604	28	NTN				
	680,000	500,000	640,00	E-4R9604	28	NTN				
	700,000	100,000	124,00	N1096	20	NTN				
	700,000	100,000	126,00	NJ1096	18	NTN				
	700,000	100,000	126,00	NU1096	17	NTN				
	700,000	100,000	126,00	NUP1096	19	NTN				
	790,000	308,000	552,00	2RT19607	36	NTN				
	875,000	260,000	724,00	2RNU9610	24	NTN				
	960,000	175,000	562,00	2RT9605	36	NTN				
	500,000	600,000	46,000	23,60	RN10005	17	NTN			
620,000		56,000	37,68	NF18/500	22	NTN				
620,000		56,000	38,60	NU18/500	17	NTN				
620,000		72,000	50,70	NU28/500	17	NTN				
670,000		78,000	81,30	NU19/500	17	NTN				
680,000		420,000	495,00	4R10010	28	NTN				
680,000		420,000	451,00	4R10020	28	NTN				
680,000		420,000	495,00	E-4R10010	28	NTN				
690,000		470,000	590,00	4R10016	28	NTN				
690,000		470,000	590,00	E-4R10016	28	NTN				
690,000		510,000	640,00	4R10006	28	NTN				
690,000		510,000	640,00	E-4R10006	28	NTN				
700,000		515,000	680,00	4R10011	28	NTN				
700,000		515,000	680,00	E-4R10011	28	NTN				
710,000		480,000	675,00	4R10008	28	NTN				
710,000		480,000	675,00	E-4R10008	28	NTN				
720,000		100,000	128,00	N10/500	20	NTN				
720,000		100,000	130,00	NJ10/500	18	NTN				
720,000		100,000	134,00	NU10/500	17	NTN				
720,000		100,000	130,00	NUP10/500	19	NTN				
720,000		270,000	360,00	RNNU10024	24	NTN				
720,000		530,000	780,00	4R10015	28	NTN				
720,000		530,000	745,00	4R10024	28	NTN				
720,000		530,000	780,00	E-4R10015	28	NTN				
800,000		350,000	690,00	RNN10005	24	NTN				
830,000		264,000	588,00	NU31/500	17	NTN				
900,000		210,000	598,00	RNU10010	17	NTN				
920,000		336,000	1 020,00	2RNU10006	24	NTN				
505,000		820,000	290,000	656,00	2RNU10101	24	NTN			
510,000		670,000	320,000	335,00	4R10201	28	NTN			
		670,000	320,000	335,00	E-4R10201	28	NTN			
	700,000	540,000	689,00	4R10202	28	NTN				
	700,000	540,000	689,00	E-4R10202	28	NTN				
520,000	640,000	175,000	112,40	RNNU10407	24	NTN				

								Brands	
d	D	B	Kg	Reference					
520,000	700,000	540,000	658,00	4R10403	28	NTN			
	700,000	540,000	658,00	E-4R10403	28	NTN			
	720,000	550,000	715,00	4R10406	28	NTN			
	735,000	390,000	422,00	ER10406V	17	NTN			
	735,000	535,000	740,00	4R10402	28	NTN			
	735,000	535,000	740,00	E-4R10402	28	NTN			
	1 000,000	140,000	446,00	2RT10404	36	NTN			
521,333	800,000	100,000	188,00	R10405K	17	NTN			
530,000	650,000	56,000	37,70	NFV18/530	22	NTN			
	650,000	56,000	41,60	NU18/530	17	NTN			
	650,000	72,000	51,50	NJ28/530	18	NTN			
	700,000	540,000	626,00	4R10603	28	NTN			
	700,000	540,000	626,00	E-4R10603	28	NTN			
	710,000	82,000	95,90	NU19/530	17	NTN			
	710,000	106,000	124,00	NU29/530	17	NTN			
	760,000	520,000	800,00	4R10601	28	NTN			
	760,000	520,000	800,00	E-4R10601	28	NTN			
	780,000	112,000	192,00	NU10/530	17	NTN			
	780,000	185,000	318,00	NU30/530	17	NTN			
	780,000	570,000	1 010,00	4R10602	28	NTN			
	780,000	570,000	978,00	4R10606	28	NTN			
	780,000	570,000	1 010,00	E-4R10602	28	NTN			
	920,000	330,000	976,00	2RNU10602	24	NTN			
	536,180	762,030	558,800	859,00	4R10704	28	NTN		
540,000	705,000	100,000	98,50	RT10802	36	NTN			
	960,000	343,000	1 170,00	2RNU10803	24	NTN			
550,000	800,000	520,000	965,00	4R11001	28	NTN			
	800,000	520,000	965,00	E-4R11001	28	NTN			
559,000	762,000	102,000	144,00	2RT11213	36	NTN			
560,000	660,000	50,000	50,00	2RT11207	36	NTN			
	680,000	72,000	56,10	NU28/560	17	NTN			
	680,000	90,000	72,70	NU38/560	17	NTN			
	680,000	360,000	265,00	4R11202	28	NTN			
	680,000	360,000	265,00	E-4R11202	28	NTN			
	735,000	170,000	220,00	RNNU11208	24	NTN			
	740,000	240,000	280,00	RNNU11207	24	NTN			
	750,000	85,000	112,00	NFV19/560	22	NTN			
	750,000	85,000	91,40	NU19/560	17	NTN			
	750,000	112,000	146,00	NU29/560	17	NTN			
570,000	820,000	115,000	216,00	NU10/560	17	NTN			
	850,000	175,000	387,00	2RT11215	36	NTN			
	880,000	260,000	546,00	2R11203	24	NTN			
	800,000	514,000	849,00	4R11404	28	NTN			
	815,000	594,000	1 040,00	4R11402	28	NTN			
	815,000	594,000	1 040,00	E-4R11402	28	NTN			
575,000	950,000	270,000	807,00	RNNU11501	24	NTN			
580,000	670,000	54,000	31,00	RT11704	36	NTN			
	680,000	110,000	65,70	RNNU11601	24	NTN			
	780,000	100,000	140,00	RNU11601	17	NTN			
	1 000,000	350,000	1 200,00	2RNU11603	24	NTN			
	1 070,000	220,000	965,00	RNU11604	17	NTN			

								Brands	
d	D	B	Kg	Reference					
600,000	730,000	78,000	70,70	NU28/600	17	NTN			
	800,000	90,000	132,00	NU19/600	17	NTN			
	800,000	90,000	109,00	R12001	17	NTN			
	800,000	118,000	170,00	N29/600	20	NTN			
	800,000	118,000	165,00	NFV29/600	22	NTN			
	800,000	118,000	171,19	NU29/600	17	NTN			
	820,000	575,000	941,00	4R12006	28	NTN			
	820,000	575,000	980,00	E-4R12003	28	NTN			
	870,000	200,000	416,00	NU30/600	17	NTN			
	870,000	540,000	1 150,00	4R12002	28	NTN			
	870,000	540,000	1 150,00	E-4R12002	28	NTN			
	870,000	640,000	1 330,00	4R12001	28	NTN			
	870,000	640,000	1 330,00	E-4R12001	28	NTN			
	1 130,000	175,000	660,00	2RT12013	36	NTN			
	1 130,000	175,000	660,00	2RT12015	36	NTN			
	605,000	960,000	125,000	326,00	2RT12101	36	NTN		
980,000		290,000	935,00	2RNU12101	24	NTN			
610,000	813,000	102,000	186,00	2RT12201	36	NTN			
	850,000	290,000	516,00	RNNU12203	24	NTN			
	870,000	660,000	1 400,00	4R12202	28	NTN			
	870,000	660,000	1 400,00	E-4R12202	28	NTN			
628,000	922,000	600,000	1 430,00	4R12602	28	NTN			
630,000	780,000	69,000	72,80	NFV18/630	22	NTN			
	780,000	88,000	97,50	NU28/630	17	NTN			
	850,000	100,000	166,00	NF19/630	22	NTN			
	850,000	100,000	162,00	NU19/630	17	NTN			
	850,000	128,000	218,00	NU29/630	17	NTN			
	920,000	128,000	302,00	NU10/630	17	NTN			
640,000	880,000	600,000	1 150,00	4R12802	28	NTN			
650,000	730,000	57,000	29,00	RT13004	36	NTN			
	780,000	100,000	80,30	RT13001	36	NTN			
	920,000	670,000	1 500,00	4R13005	28	NTN			
	920,000	670,000	1 500,00	E-4R13005	28	NTN			
	920,000	680,000	1 510,00	4R13010	28	NTN			
	920,000	690,000	1 550,00	4R13003	28	NTN			
	920,000	690,000	1 550,00	E-4R13003	28	NTN			
660,000	820,000	440,000	580,00	4R13201	28	NTN			
	820,000	440,000	580,00	E-4R13201	28	NTN			
663,800	740,000	38,100	21,20	RNUP13301	19	NTN			
670,000	820,000	69,000	75,00	NFV18/670	22	NTN			
	820,000	88,000	103,00	NU28/670	17	NTN			
	820,000	112,000	136,00	NU38/670	17	NTN			
	900,000	103,000	195,00	NU19/670	17	NTN			
	900,000	136,000	257,00	NU29/670	17	NTN			
	900,000	200,000	330,00	R3402	17	NTN			
	1 130,000	200,000	860,00	2RT14003	36	NTN			
	1 150,000	380,000	1 570,00	RNNU13404	24	NTN			
	1 160,000	410,000	1 790,00	2RNU13401	24	NTN			
677,000	1 060,000	127,000	390,00	2RT13502	36	NTN			
680,000	840,000	180,000	216,00	RNN13602	24	NTN			
	1 020,000	650,000	1 970,00	4R13603	28	NTN			

								Brands	
d	D	B	Kg	Reference					
680,000	1 020,000	680,000	2 060,00	4R13604	28	NTN			
690,000	980,000	715,000	1 850,00	4R13802	28	NTN			
	980,000	715,000	1 850,00	E-4R13802	28	NTN			
	980,000	750,000	1 900,00	4R13803	28	NTN			
700,000	930,000	620,000	1 200,00	E-4R14003	28	NTN			
710,000	900,000	112,000	172,00	RN14205	17	NTN			
	950,000	106,000	221,00	NU19/710	17	NTN			
	950,000	140,000	232,00	NJ29/710	18	NTN			
	950,000	140,000	287,34	NU29/710	17	NTN			
	950,000	145,000	312,00	2RT14208	36	NTN			
	950,000	345,000	628,00	2RT14204	36	NTN			
	1 000,000	715,000	1 900,00	4R14205	28	NTN			
	1 000,000	715,000	1 900,00	E-4R14205	28	NTN			
	1 030,000	236,000	677,00	NU30/710	17	NTN			
725,000	1 000,000	700,000	1 730,00	4R14501	28	NTN			
	1 000,000	700,000	1 730,00	E-4R14501	28	NTN			
730,000	1 280,000	225,000	1 130,00	2RT15002	36	NTN			
740,000	1 000,000	115,000	264,00	RNU14801	17	NTN			
750,000	1 000,000	112,000	257,00	NU19/750	17	NTN			
	1 000,000	145,000	332,00	NU29/750	17	NTN			
	1 050,000	745,000	2 180,00	4R15001	28	NTN			
	1 050,000	745,000	2 180,00	E-4R15001	28	NTN			
	1 090,000	745,000	2 530,00	4R15002	28	NTN			
	1 090,000	745,000	2 530,00	E-4R15002	28	NTN			
755,000	1 070,000	750,000	2 260,00	4R15101	28	NTN			
760,000	840,000	57,000	34,15	RT15207	36	NTN			
	1 030,000	750,000	2 000,00	4R15204	28	NTN			
	1 030,000	750,000	2 000,00	E-4R15204	28	NTN			
	1 080,000	805,000	2 550,00	4R15207	28	NTN			
	1 080,000	805,000	2 550,00	E-4R15207	28	NTN			
	1 100,000	745,000	2 560,00	4R15203	28	NTN			
	1 100,000	745,000	2 560,00	E-4R15203	28	NTN			
761,430	1 079,600	787,400	2 420,00	4R15201	28	NTN			
765,000	1 250,000	175,000	772,00	2RT15302	36	NTN			
793,000	1 055,000	100,000	223,00	2RT15901	36	NTN			
800,000	950,000	90,000	120,00	RT16005	36	NTN			
	980,000	106,000	169,00	NFV28/800	22	NTN			
	980,000	106,000	178,00	NU28/800	17	NTN			
	1 060,000	150,000	380,00	NU29/800	17	NTN			
	1 080,000	700,000	1 950,00	4R16004	28	NTN			
	1 080,000	700,000	1 950,00	E-4R16004	28	NTN			
	1 080,000	750,000	2 090,00	4R16005	28	NTN			
	1 080,000	750,000	2 090,00	E-4R16005	28	NTN			
	1 150,000	155,000	554,00	NU10/800	17	NTN			
	1 373,124	192,024	1 200,00	2RT16009	36	NTN			
812,700	1 016,000	127,000	258,00	2RT16301	36	NTN			
820,000	1 130,000	800,000	2 450,00	4R16406	28	NTN			

										Brands	
d	D	B	Kg	Reference							
820,000	1 130,000	800,000	2 530,00	4R16413	28	NTN					
	1 130,000	800,000	2 530,00	4R16415	28	NTN					
	1 130,000	800,000	2 450,00	E-4R16406	28	NTN					
	1 130,000	825,000	2 520,00	4R16405	28	NTN					
	1 130,000	825,000	2 520,00	E-4R16405	28	NTN					
	1 160,000	840,000	2 930,00	4R16403	28	NTN					
	1 160,000	840,000	2 930,00	E-4R16403	28	NTN					
830,000	1 040,000	115,000	219,00	RNU16603	17	NTN					
	1 080,000	710,000	1 780,00	4R16601	28	NTN					
	1 090,000	115,000	285,00	RNU16602	17	NTN					
	1 090,000	115,000	281,00	RNU16604	17	NTN					
838,200	1 041,400	88,900	182,00	E-RNF16801	22	NTN					
840,000	1 160,000	840,000	2 840,00	4R16801	28	NTN					
	1 160,000	840,000	2 840,00	E-4R16801	28	NTN					
850,000	1 030,000	106,000	188,00	NU28/850	17	NTN					
	1 050,000	125,000	245,00	RNJ17002	18	NTN					
	1 120,000	118,000	271,00	NU19/850	17	NTN					
	1 120,000	155,000	432,00	NU29/850	17	NTN					
	1 120,000	160,000	460,00	2RT17002	36	NTN					
	1 150,000	650,000	1 980,00	4R17001	28	NTN					
	1 150,000	650,000	1 980,00	E-4R17001	28	NTN					
	1 150,000	800,000	2 430,00	4R17003	28	NTN					
	1 150,000	800,000	2 430,00	E-4R17003	28	NTN					
	1 150,000	840,000	2 640,00	4R17009	28	NTN					
	1 180,000	650,000	2 270,00	4R17004	28	NTN					
	1 180,000	650,000	2 270,00	E-4R17004	28	NTN					
	1 180,000	850,000	2 970,00	4R17002	28	NTN					
	1 180,000	850,000	2 980,00	4R17014	28	NTN					
	1 180,000	850,000	2 970,00	E-4R17002	28	NTN					
860,000	1 140,000	750,000	2 200,00	4R17202	28	NTN					
	1 160,000	735,000	2 310,00	4R17201	28	NTN					
	1 160,000	735,000	2 310,00	E-4R17201	28	NTN					
863,600	1 066,800	146,050	309,00	E-RNF17301	22	NTN					
900,000	1 060,000	130,000	220,00	RT18003	36	NTN					
	1 230,000	895,000	3 250,00	4R18001	28	NTN					
	1 230,000	895,000	3 250,00	E-4R18001	28	NTN					
	1 375,000	200,000	987,00	2RT18001	36	NTN					
910,000	1 430,000	180,000	945,00	2RT18204	36	NTN					
920,000	1 280,000	865,000	3 560,00	4R18401	28	NTN					
	1 280,000	865,000	3 560,00	E-4R18401	28	NTN					
945,000	1 055,000	60,000	67,00	RT19008	36	NTN					
950,000	1 250,000	180,000	644,00	2RT19008	36	NTN					
970,000	1 550,000	200,000	1 225,00	2RT19402	36	NTN					
980,000	1 600,000	175,000	1 250,00	2RT19602	36	NTN					
	1 600,000	181,000	1 256,00	2RT19606	36	NTN					
	1 600,000	190,000	1 520,00	2RT19605	36	NTN					
1 000,000	1 310,000	880,000	3 260,00	4R20001	28	NTN					
	1 310,000	880,000	3 260,00	E-4R20001	28	NTN					

										Brands	
d	D	B	Kg	Reference							
1 000,000	1 360,000	800,000	3 530,00	4R20002	28	NTN					
	1 360,000	800,000	3 530,00	E-4R20002	28	NTN					
1 023,000	1 600,000	192,000	1 410,00	2RT20501	36	NTN					
1 030,000	1 380,000	850,000	3 800,00	4R20601	28	NTN					
	1 380,000	850,000	3 800,00	E-4R20601	28	NTN					
1 060,000	1 400,000	195,000	855,00	NU29/1060	17	NTN					
1 090,000	1 580,000	175,000	1 288,00	2RT21801	36	NTN					
1 093,600	1 601,724	192,024	1 370,00	2RT21904	36	NTN					
1 093,724	1 601,724	192,024	1 453,00	2RT21902	36	NTN					
1 105,000	1 600,000	175,000	1 165,00	2RT22101	36	NTN					
1 110,000	1 750,000	220,000	1 829,00	2RT20006	36	NTN					
1 130,000	1 750,000	190,000	1 350,00	2RT22604	36	NTN					
1 180,000	1 540,000	206,000	1 060,00	NU29/1180	17	NTN					
	1 540,000	206,000	1 090,00	NUP29/1180	19	NTN					
1 200,000	1 590,000	1 050,000	6 220,00	4R24002	28	NTN					
	1 590,000	1 050,000	6 220,00	E-4R24002	28	NTN					
1 210,000	1 380,000	97,000	206,00	R4803	17	NTN					
	1 700,000	200,000	1 320,00	2RT24201	36	NTN					
1 250,000	1 630,000	170,000	975,00	NU19/1250	17	NTN					
1 260,000	1 580,000	335,000	1 580,00	E-RNU25201	17	NTN					
	1 850,000	240,000	2 260,00	2RT25201	36	NTN					
1 410,000	2 000,000	200,000	1 870,00	2RT28205	36	NTN					
	2 000,000	200,000	1 602,00	2RT28206	36	NTN					
	2 100,000	240,000	2 760,00	2RT28204	36	NTN					
1 440,000	1 580,000	97,000	237,00	R8803	17	NTN					
1 600,000	1 795,000	111,000	380,00	RT32503	36	NTN					

Classification by dimensions – Classement par dimensions
Klassifizierung nach Abmessungen – Classificazione per dimensione
Clasificación por dimensiones – Classificação por dimensões
Классификация по размерам – Klasyfikacja wg wymiarów



Tapered roller bearing



Kegelrollenlager



Rodamientos de rodillos cónicos



Конические роликоподшипники



Roulements à rouleaux coniques



Cuscintetti a rulli conici



Rolamentos de rolos cónicos









Łożyska stożkowe





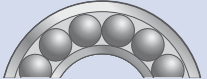



								Brands
d	D	B	C	T	Kg	Reference		
12,000	31,991	10,785	7,938	10,785	0,04	4T-A2047/A2126	29	NTN
		10,785			0,02	4T-A2047	29	NTN
12,700	34,988	10,988	8,730	10,998	0,05	4T-A4050/A4138	29	NTN
		10,988			0,03	4T-A4050	29	NTN
14,989	34,988	10,988	8,730	10,988	0,05	4T-A4059/A4138	29	NTN
15,000	35,000	11,000	10,000	11,750	0,05	30202 A	29	SNR
	42,000	13,000	11,000	14,250	0,10	30302	29	NTN
		10,988			0,03	4T-A4059	29	NTN
15,875	34,988	11,000	8,712	10,998	0,05	4T-L21549/L21511	29	NTN
	41,275	14,681	11,112	14,681	0,09	4T-03062/03162	29	NTN
	42,862	16,670	13,495	16,670	0,12	4T-17580/17520	29	NTN
	42,863	14,288	9,525	14,288	0,10	4T-11590/11520	29	NTN
	47,000	14,381	11,112	14,381	0,13	4T-05062/05185	29	NTN
	49,225	21,539	14,288	21,539	0,20	4T-09062/09195	29	NTN
		14,381			0,08	4T-05062	29	NTN
		21,539			0,14	4T-09062	29	NTN
		11,000			0,03	4T-L21549	29	NTN
		14,288			0,06	4T-11590	29	NTN
		14,681			0,06	4T-03062	29	NTN
		16,670			0,07	4T-17580	29	NTN
16,000		21,000			0,11	4T-HM81649	29	NTN
16,993	47,000	14,381	11,112	14,381	0,13	4T-05066/05185	29	NTN
		11,153			0,04	4T-A6067	29	NTN
17,000	40,000	12,000	11,000	13,250	0,08	30203	29	NTN
	40,000	12,000	11,000	13,250	0,08	30203 A	29	SNR
	40,000	16,000	14,000	17,250	0,10	32203	29	NTN
	40,000	16,000	14,000	17,250	0,11	32203 A	29	SNR
	47,000	14,000	12,000	15,250	0,13	30303	29	NTN
	47,000	14,000	12,000	15,250	0,13	30303 A	29	SNR
17,462	39,878	14,605	10,668	14,605	0,08	4T-LM11749/LM11710	29	NTN
		14,381			0,08	4T-05068	29	NTN
		14,605			0,06	4T-LM11749	29	NTN
19,050	39,992	11,153	9,525	12,014	0,07	4T-A6075/A6157	29	NTN
	44,450	11,908	9,525	12,700	0,09	4T-4A/6	29	NTN
	45,237	16,637	12,065	16,637	0,12	4T-LM11949/LM11910	29	NTN
	45,237	16,637	12,065	17,066	0,13	4T-LM11949L/LM11910	29	NTN
	47,000	14,381	11,112	14,381	0,12	4T-05075/05185	29	NTN
	49,225	19,050	14,288	19,845	0,17	4T-09067/09195	29	NTN
	49,225	19,050	14,288	19,845	0,19	4T-09074/09195	29	NTN
	49,225	19,050	17,462	23,020	0,20	4T-09067/09196	29	NTN
	49,225	19,050	17,462	23,020	0,20	4T-09074/09194	29	NTN
	49,225	19,050	17,462	23,020	0,21	4T-09074/09196	29	NTN
	49,225	21,539	14,288	19,845	0,19	4T-09078/09195	29	NTN
	53,975	21,839	15,875	22,225	0,25	4T-21075/21212	29	NTN
	56,896	19,837	15,875	19,368	0,27	4T-1775/1729	29	NTN
		11,153			0,03	4T-A6075	29	NTN
		14,381			0,08	4T-05075	29	NTN
		16,637			0,08	4T-LM11949L	29	NTN
		16,637			0,08	4T-LM11949	29	NTN
		19,050			0,11	4T-09067	29	NTN
		19,837			0,17	4T-1775	29	NTN
	21,539			0,12	4T-09074	29	NTN	
	21,839			0,15	4T-21075	29	NTN	



							 Brands
d	D	B	C	T	Kg	Reference	
19,063		21,539			0,12	4T-09078	29 NTN
19,987		14,381			0,07	4T-05079	29 NTN
20,000	42,000	15,000	12,000	15,000	0,10	32004X	29 NTN
	42,000	30,000			0,20	4T-32004XDF	30 NTN
	47,000	14,000	12,000	15,250	0,13	30204	29 NTN
	47,000	14,000	12,000	15,250	0,12	30204 A	29 SNR
	47,000	14,381	11,112	14,381	0,12	4T-05079/05185	29 NTN
	47,000	14,381	11,112	14,381	0,12	4T-05079/05185S	29 NTN
	47,000	18,000	15,000	19,250	0,16	32204	29 NTN
	50,005	14,260	9,525	14,260	0,14	4T-07079/07196	29 NTN
	52,000	15,000	11,000	16,250	0,17	31304	29 SNR
	52,000	15,000	13,000	16,250	0,18	30304 A	29 SNR
	52,000	16,000	12,000	16,250	0,17	30304CA	29 NTN
	52,000	21,000	18,000	22,250	0,24	32304	29 NTN
	52,000	21,000	18,000	22,250	0,25	32304 A	29 SNR
		14,260			0,10	4T-07079	29 NTN
20,625	49,225	21,539	14,288	21,539	0,18	4T-09081/09195	29 NTN
	49,225	21,539	17,462	23,020	0,19	4T-09081/09196	29 NTN
		21,539			0,11	4T-09081	29 NTN
20,638	49,225	19,845	15,875	19,845	0,18	4T-12580/12520	29 NTN
		19,845			0,11	4T-12580	29 NTN
21,430	45,237	16,637	12,065	16,637	0,12	4T-LM12748/LM12710	29 NTN
	50,005	13,470	17,788	17,788	0,16	4T-CR-0468	29 NTN
	50,005	18,288	13,970	18,288	0,17	4T-M12649/M12610	29 NTN
		16,637			0,08	4T-LM12748	29 NTN
		18,288			0,11	4T-M12649	29 NTN
21,986	45,237	16,637	12,065	16,637	0,12	4T-LM12749/LM12710	29 NTN
	45,974	16,637	12,065	16,637	0,12	4T-LM12749/LM12711	29 NTN
		16,637			0,08	4T-LM12749	29 NTN
22,000	44,000	15,000	11,500	15,000	0,10	320/22X	29 NTN
22,225	50,005	14,260	9,525	14,260	0,13	4T-07087/07196	29 NTN
	50,005	18,288	13,970	17,526	0,17	4T-M12648/M12610	29 NTN
	50,800	14,260	12,700	15,011	0,15	4T-07087/07210X	29 NTN
	50,800	14,260	12,700	15,011	0,15	4T-07087X/07210X	29 NTN
	51,994	14,260	12,700	15,011	0,16	4T-07087/07204	29 NTN
	52,388	20,168	14,288	23,178	0,20	4T-1380/1328	29 NTN
	56,896	19,837	15,875	19,368	0,26	4T-1755/1729	29 NTN
	57,150	22,225	17,462	22,225	0,29	4T-1280/1220	29 NTN
	60,325	19,355	15,875	19,845	0,29	4T-1975/1931	29 NTN
		14,260			0,10	4T-07087	29 NTN
		14,260			0,10	4T-07087X	29 NTN
		18,288			0,11	4T-M12648	29 NTN
		18,288			0,11	4T-M12648A	29 NTN
		19,355			0,18	4T-1975	29 NTN
		19,837			0,16	4T-1755	29 NTN
		20,168			0,13	4T-1380	29 NTN
	22,225			0,18	4T-1280	29 NTN	
22,606	47,000	15,500	12,000	15,500	0,13	4T-LM72849/LM72810	29 NTN
23,812	50,005	14,260	9,525	14,260	0,11	4T-CR-0594	29 NTN
	50,292	14,732	10,668	14,224	0,14	4T-L44640/L44610	29 NTN
	56,896	19,837	15,875	19,368	0,25	4T-1779/1729	29 NTN
		14,260			0,09	4T-07093	29 NTN



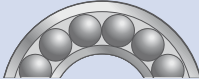



								Brands
d	D	B	C	T	Kg	Reference		
23,812		14,732			0,10	4T-L44640	29	NTN
		19,837			0,15	4T-1779	29	NTN
		30,416			0,30	4T-3659	29	NTN
24,981	50,005	14,260	9,525	13,495	0,12	4T-07098/07196	29	NTN
	62,000	16,566	14,288	16,002	0,26	4T-17098/17244	29	NTN
		14,260			0,08	4T-07098	29	NTN
25,000	47,000	15,000	11,500	15,000	0,11	32005X	29	NTN
	47,000	17,000	14,000	17,000	0,13	33005	29	NTN
	50,005	14,260	9,525	13,495	0,12	4T-07097/07196	29	NTN
	52,000	15,000	13,000	16,250	0,15	30205	29	NTN
	52,000	15,000	13,000	16,250	0,16	30205 A	29	SNR
	52,000	18,000	15,000	19,250	0,19	4T-CR-0566	29	NTN
	52,000	18,000	15,000	19,250	0,19	32205 BA	29	SNR
	52,000	18,000	15,000	19,250	0,19	32205C	29	NTN
	52,000	18,000	16,000	19,250	0,19	32205	29	NTN
	52,000	22,000	18,000	22,000	0,22	33205	29	NTN
	52,000	22,000	18,000	22,000	0,23	33205 A	29	SNR
	62,000	-			0,55	4T-30305DF	30	NTN
	62,000	17,000	13,000	18,250	0,25	30305D	29	NTN
	62,000	17,000	13,000	18,250	0,26	31305 V	29	SNR
	62,000	17,000	14,000	18,250	0,26	30305C	29	NTN
	62,000	17,000	15,000	18,250	0,27	30305	29	NTN
	62,000	17,000	15,000	18,250	0,27	30305 A	29	SNR
	62,000	17,000	15,000	18,250	0,26	30305 C	29	SNR
	62,000	24,000	20,000	25,250	0,38	32305	29	NTN
	62,000	24,000	20,000	25,250	0,37	32305 A	29	SNR
	62,000	40,000			0,25	430305DX	30	NTN
	14,260			0,08	4T-07097	29	NTN	
25,159	50,005	14,260	9,525	13,495	0,12	4T-07096/07196	29	NTN
25,400	50,005	14,260	9,525	13,495	0,12	4T-07100/07196	29	NTN
	50,005	14,260	9,525	14,260	0,12	4T-07100S/07196	29	NTN
	50,292	14,732	10,668	14,732	0,13	4T-L44643/L44610	29	NTN
	50,292	14,732	10,668	14,732	0,13	4T-L44643L/L44610	29	NTN
	50,800	14,260	12,700	15,011	0,13	4T-07100/07210X	29	NTN
	50,800	14,260	12,700	15,011	0,13	4T-07100S/07210X	29	NTN
	50,800	14,260	12,700	15,011	0,13	4T-07100SA/07210X	29	NTN
	51,994	14,260	12,700	15,011	0,14	4T-07100/07204	29	NTN
	51,994	14,260	12,700	15,011	0,14	4T-07100S/07204	29	NTN
	56,896	19,837	15,875	19,368	0,24	4T-1780/1729	29	NTN
	57,150	17,462	13,495	17,462	0,21	4T-15578/15520	29	NTN
	57,150	19,355	15,875	19,845	0,24	4T-1986/1922	29	NTN
	57,150	19,431	14,732	19,431	0,24	4T-M84548/M84510	29	NTN
	59,530	23,114	18,288	23,368	0,32	4T-M84249/M84210	29	NTN
	60,325	17,462	15,875	19,842	0,27	4T-15578/15523	29	NTN
	60,325	19,355	15,875	19,845	0,26	4T-1986/1931	29	NTN
	61,912	20,638	14,288	19,050	0,30	4T-15101/15243	29	NTN
	62,000	20,638	14,288	20,638	0,30	4T-15100/15245	29	NTN
	62,000	20,638	14,288	20,638	0,29	4T-15100S/15245	29	NTN
	62,000	20,638	14,288	20,638	0,30	4T-15101/15245	29	NTN
	63,100	25,433	19,050	23,812	0,39	4T-2687/2620	29	NTN
	63,500	20,638	15,875	20,638	0,33	4T-15100/15250X	29	NTN
	63,500	20,638	15,875	20,638	0,33	4T-15100S/15250X	29	NTN
	63,500	20,638	15,875	20,638	0,34	4T-15101/15250X	29	NTN
	64,292	21,433	16,670	21,433	0,37	4T-M86643/M86610	29	NTN
	65,088	21,463	15,875	22,225	0,36	4T-23100/23256	29	NTN
	66,421	25,433	19,050	25,433	0,44	4T-2687/2631	29	NTN
	68,262	22,225	17,462	22,225	0,43	4T-02473/02420	29	NTN
		14,260			0,08	4T-07100	29	NTN



							 Brands
d	D	B	C	T	Kg	Reference	
25,400		14,260			0,08	4T-07100S	29 NTN
		14,260			0,08	4T-07100SA	29 NTN
		14,732			0,09	4T-L44643L	29 NTN
		14,732			0,09	4T-L44643	29 NTN
		19,355			0,16	4T-1986	29 NTN
		19,431			0,15	4T-M84548	29 NTN
		19,837			0,14	4T-1780	29 NTN
		20,638			0,21	4T-15100S	29 NTN
		20,638			0,22	4T-15100	29 NTN
		20,638			0,23	4T-15101	29 NTN
		20,638			0,22	4T-15102	29 NTN
		21,433			0,24	4T-M86643	29 NTN
		21,463			0,22	4T-23100	29 NTN
		22,225			0,28	4T-02473	29 NTN
		23,114			0,19	4T-M84249	29 NTN
		25,400			0,39	4T-HM88630	29 NTN
	25,433			0,28	4T-2687	29 NTN	
25,413		17,462			0,15	4T-15578	29 NTN
26,000	57,150	17,462	13,495	17,462	0,21	4T-15579X/15520	29 NTN
		17,462			0,14	4T-15579X	29 NTN
26,010	47,000	13,000	11,500	15,000	0,06	4T-CR-0574	29 NTN
26,157	62,000	20,638	14,288	19,050	0,30	4T-15103/15245	29 NTN
26,162	61,912	19,939	14,288	19,939	0,29	4T-15103S/15243	29 NTN
	66,421	25,433	19,050	23,812	0,44	4T-2682/2631	29 NTN
		19,939			0,21	4T-15103S	29 NTN
26,988	50,292	14,732	10,668	14,732	0,12	4T-L44649/L44610	29 NTN
	57,150	17,462	13,495	17,462	0,21	4T-15580/15520	29 NTN
	62,000	20,638	14,288	20,638	0,29	4T-15106/15245	29 NTN
	62,000	20,638	15,875	20,638	0,32	4T-15106/15250	29 NTN
	63,500	20,638	15,875	20,638	0,32	4T-15106/15250X	29 NTN
		14,732			0,08	4T-L44649	29 NTN
		17,462			0,14	4T-15580	29 NTN
		20,638			0,21	4T-15106	29 NTN
		25,433			0,25	4T-2688	29 NTN
27,000	57,150	19,431	14,732	19,431	0,23	4T-M84549/M84510	29 NTN
28,000	50,292	16,724	10,668	16,724	0,11	4T-CR-0676	29 NTN
	52,000	16,000	12,000	16,000	0,15	320/28X	29 NTN
	58,000	16,000	14,000	17,250	0,20	302/28	29 NTN
	58,000	19,000	16,000	20,250	0,24	322/28R	29 NTN
	58,000	20,000	16,000	20,000	0,25	4T-CR-0620	29 NTN
	58,000	24,000	19,000	24,000	0,29	332/28	29 NTN
28,575	56,896	19,355	15,875	19,845	0,22	4T-1985/1930	29 NTN
	57,150	17,462	13,495	17,462	0,19	4T-15590/15520	29 NTN
	57,150	19,355	15,875	19,845	0,22	4T-1985/1922	29 NTN
	57,150	19,355	15,875	19,845	0,21	4T-1988/1922	29 NTN
	58,738	19,355	15,080	19,355	0,23	4T-1985/1932	29 NTN
	60,325	17,462	15,875	19,842	0,25	4T-15590/15523	29 NTN
	60,325	19,355	15,875	19,845	0,26	4T-1985/1931	29 NTN
	62,000	20,638	14,288	20,638	0,28	4T-15112/15245	29 NTN
	62,000	20,638	14,288	20,638	0,28	4T-15113/15245	29 NTN
	63,500	20,638	15,875	20,638	0,31	4T-15112/15250	29 NTN
	64,292	21,433	16,670	21,433	0,35	4T-M86647/M86610	29 NTN
	66,421	25,433	19,050	25,433	0,41	4T-2689/2631	29 NTN



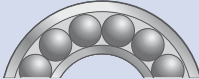



								Brands
d	D	B	C	T	Kg	Reference		
28,575	68,262	22,225	17,462	22,225	0,41	4T-02474/02420	29	NTN
	68,262	22,225	17,462	22,225	0,42	4T-M88040/M88010	29	NTN
	68,262	23,812	17,462	22,225	0,41	4T-2474/2420	29	NTN
	69,850	25,357	19,050	25,357	0,48	4T-2578/2523	29	NTN
	72,626	24,257	17,462	24,608	0,47	4T-41125/41286	29	NTN
	73,025	22,225	17,462	22,225	0,48	4T-02872/02820	29	NTN
		17,462			0,13	4T-15590	29	NTN
		19,355			0,14	4T-1985	29	NTN
		19,355			0,14	4T-1988	29	NTN
		20,638			0,20	4T-15112	29	NTN
		20,638			0,20	4T-15113	29	NTN
		21,433			0,22	4T-M86647	29	NTN
		22,225			0,26	4T-02474	29	NTN
		22,225			0,32	4T-02872	29	NTN
		22,225			0,27	4T-M88040	29	NTN
		24,257			0,29	4T-41125	29	NTN
		25,357			0,31	4T-2578	29	NTN
		25,433			0,25	4T-2689	29	NTN
		29,997			0,41	4T-3198	29	NTN
29,000	50,292	14,732	10,668	14,224	0,11	4T-L45449/L45410	29	NTN
	50,292	17,547	10,668	17,547	0,12	4T-CR-06A84	29	NTN
		14,732			0,08	4T-L45449	29	NTN
29,367	66,421	25,433	19,050	23,812	0,41	4T-2690/2631	29	NTN
		25,433			0,24	4T-2690	29	NTN
29,987	62,000	16,566	14,288	16,566	0,23	4T-17118/17244	29	NTN
	62,000	20,638	14,288	20,638	0,27	4T-15117/15245	29	NTN
		16,566			0,14	4T-17118	29	NTN
30,000	51,000	15,000	11,000	15,000	0,12	4T-CR-0627	29	NTN
	52,000	16,000	11,500	16,000	0,13	4T-CR-0643	29	NTN
	52,000	16,000	11,500	16,000	0,13	4T-CR-0643L	29	NTN
	55,000	17,000	13,000	17,000	0,17	32006X	29	NTN
	55,000	17,000	13,000	17,000	0,17	32006XT2LX3	29	NTN
	55,000	20,000	16,000	20,000	0,20	33006	29	NTN
	60,037	37,000			0,48	4T-CR1-0695LL	30	NTN
	62,000	16,000	14,000	17,250	0,24	30206	29	NTN
	62,000	16,000	14,000	17,250	0,24	30206 A	29	SNR
	62,000	20,000	17,000	21,250	0,30	32206	29	NTN
	62,000	20,000	17,000	21,250	0,30	32206C	29	NTN
	62,000	20,000	17,000	21,250	0,29	32206 C	29	SNR
	62,000	20,638	15,875	20,638	0,28	4T-15117/15244	29	NTN
	62,000	25,000	19,500	25,000	0,34	33206	29	NTN
	62,000	25,000	19,500	25,000	0,36	33206 A	29	SNR
	69,012	19,583	15,875	19,845	0,37	4T-14117A/14276	29	NTN
	69,012	46,040			0,86	4T-CR1-0691	30	NTN
	72,000	19,000	14,000	20,750	0,40	30306D	29	NTN
	72,000	19,000	14,000	20,750	0,41	31306 A	29	SNR
	72,000	19,000	16,000	20,750	0,40	30306	29	NTN
	72,000	19,000	16,000	20,750	0,42	30306 A	29	SNR
	72,000	27,000	23,000	28,750	0,57	32306	29	NTN
	72,000	27,000	23,000	28,750	0,58	32306 A	29	SNR
	72,000	27,000	23,000	28,750	0,33	32306C	29	NTN
	72,000	27,783	23,020	29,370	0,61	4T-JHM88540/JHM88513	29	NTN
	72,000	45,000			0,84	4T-430306DX	30	NTN
	72,085	19,202	18,415	22,385	0,44	4T-14118/14283	29	NTN
		19,202			0,23	4T-14118	29	NTN
		19,583			0,23	4T-14117A	29	NTN
		20,638			0,19	4T-15117	29	NTN



							 Brands
d	D	B	C	T	Kg	Reference	
30,005	88,900	50,803			1,56	NA15117SW/K33867	30 NTN
30,009		19,583			0,24	4T-14118S	29 NTN
30,112	62,000	20,638	14,288	19,050	0,27	4T-15116/15245	29 NTN
		20,638			0,19	4T-15116	29 NTN
30,162	62,000	16,566	14,288	16,566	0,23	4T-17119/17244	29 NTN
	64,292	21,433	16,670	21,433	0,34	4T-M86649/M86610	29 NTN
	68,262	22,225	17,462	22,225	0,40	4T-M88043/M88010	29 NTN
	69,850	25,357	19,050	23,812	0,47	4T-2558/2523	29 NTN
	69,850	25,357	19,050	23,812	0,46	4T-2558/2523S	29 NTN
	72,626	29,997	23,812	30,162	0,62	4T-3187/3120	29 NTN
		21,433			0,21	4T-M86649	29 NTN
		22,225			0,26	4T-M88043	29 NTN
	25,357			0,30	4T-2558	29 NTN	
30,213	62,000	20,638	14,288	19,050	0,27	4T-15119/15245	29 NTN
	62,000	20,638	14,288	19,050	0,27	4T-15120/15245	29 NTN
	62,000	20,638	14,288	20,638	0,26	4T-15118/15245	29 NTN
	63,500	20,638	15,875	20,638	0,30	4T-15118/15250	29 NTN
	63,500	20,638	15,875	20,638	0,30	4T-15118/15250X	29 NTN
		20,638			0,18	4T-15118	29 NTN
		20,638			0,19	4T-15119	29 NTN
		20,638			0,19	4T-15120	29 NTN
30,226	69,012	19,583	15,875	19,845	0,37	4T-14116/14274	29 NTN
	69,012	19,583	15,875	19,845	0,37	4T-14116/14276	29 NTN
		19,583			0,24	4T-14116	29 NTN
31,750	54,000	15,000	15,000	15,000	0,13	4T-CR-0687	29 NTN
	58,738	15,080	10,716	14,684	0,16	4T-08125/08231	29 NTN
	59,131	16,167	11,811	16,167	0,18	4T-CR-0678	29 NTN
	59,131	16,764	11,811	16,764	0,18	4T-LM67048/LM67010	29 NTN
	59,131	16,764	11,811	16,764	0,18	4T-LM67048L/LM67010	29 NTN
	59,131	16,764	11,811	16,764	0,18	4T-LM67049A/LM67010	29 NTN
	59,131	18,500	11,811	18,500	0,19	4T-LM67045/LM67010	29 NTN
	62,000	19,050	14,288	19,050	0,24	4T-15123/15245	29 NTN
	62,000	20,638	14,288	19,050	0,26	4T-15126/15245	29 NTN
	62,000	20,638	14,288	20,638	0,25	4T-15125/15245	29 NTN
	66,421	25,357	20,638	25,400	0,41	4T-2580/2520	29 NTN
	68,262	22,225	17,462	22,225	0,38	4T-02475/02420	29 NTN
	68,262	22,225	17,462	22,225	0,38	4T-02476/02420	29 NTN
	68,262	22,225	17,462	22,225	0,39	4T-M88046/M88010	29 NTN
	69,012	19,583	15,875	19,845	0,36	4T-14124/14276	29 NTN
	69,012	19,583	15,875	19,845	0,35	4T-14125A/14274	29 NTN
	69,012	19,583	15,875	19,845	0,36	4T-14125A/14276	29 NTN
	69,850	25,357	19,050	23,812	0,45	4T-2580/2523	29 NTN
	69,850	25,357	19,050	25,357	0,45	4T-2580/2523S	29 NTN
	69,850	25,357	19,050	25,357	0,45	4T-2582/2523	29 NTN
	72,626	29,997	23,812	30,162	0,60	4T-3188/3120	29 NTN
	72,626	29,997	23,812	30,162	0,60	4T-3188S/3120	29 NTN
	72,626	29,997	23,812	30,162	0,60	4T-3193/3120	29 NTN
	73,025	22,225	17,462	22,225	0,45	4T-02875/02820	29 NTN
	73,025	23,812	17,462	22,225	0,47	4T-2879/2820	29 NTN
	73,025	27,783	23,020	29,370	0,61	4T-HM88542/HM88510	29 NTN
	73,812	27,783	23,020	29,370	0,64	4T-HM88542/HM88512	29 NTN
	76,200	28,575	23,020	29,370	0,69	4T-HM89440/HM89410	29 NTN
	79,375	24,074	17,462	25,400	0,58	4T-43125/43312	29 NTN
	79,375	29,771	23,812	29,370	0,77	4T-3476/3420	29 NTN
	95,250	29,900	22,225	27,783	1,13	4T-443/432	29 NTN
		16,764			0,12	4T-LM67049A	29 NTN



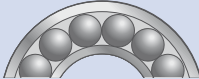



								Brands
d	D	B	C	T	Kg	Reference		
31,750		16,764			0,12	4T-LM67048	29	NTN
		16,764			0,12	4T-LM67048L	29	NTN
		18,500			0,13	4T-LM67045	29	NTN
		19,050			0,16	4T-15123	29	NTN
		19,583			0,22	4T-14124	29	NTN
		19,583			0,22	4T-14125A	29	NTN
		20,638			0,17	4T-15125	29	NTN
		20,638			0,17	4T-15126	29	NTN
		22,225			0,25	4T-M88046	29	NTN
		22,225			0,23	4T-02475	29	NTN
		22,225			0,23	4T-02476	29	NTN
		22,225			0,29	4T-02875	29	NTN
		23,812			0,24	4T-2475	29	NTN
		23,812			0,32	4T-2879	29	NTN
		24,074			0,37	4T-43125	29	NTN
		25,357			0,28	4T-2580	29	NTN
		25,357			0,28	4T-2582	29	NTN
		26,721			0,26	4T-14123A	29	NTN
		26,988			0,29	4T-23491	29	NTN
		27,783			0,38	4T-HM88542	29	NTN
	29,771			0,47	4T-3476	29	NTN	
	29,900			0,75	4T-443	29	NTN	
	29,997			0,38	4T-3188	29	NTN	
	29,997			0,38	4T-3188S	29	NTN	
	29,997			0,38	4T-3193	29	NTN	
32,000	53,000	15,000	11,500	14,500	0,12	4T-JL26749/JL26710	29	NTN
	58,000	17,000	13,000	17,000	0,19	320/32X	29	NTN
	65,000	17,000	15,000	18,250	0,18	302/32	29	NTN
	65,000	21,000	18,000	22,250	0,32	322/32	29	NTN
	65,000	26,000	15,000	27,250	0,31	4T-CR-0659	29	NTN
	65,000	26,000	20,500	26,000	0,40	332/32	29	NTN
	75,000	28,000	23,000	29,750	0,65	323/32	29	NTN
	75,000	28,000	23,000	29,750	0,66	323/32C	29	NTN
		15,000			0,08	4T-JL26749	29	NTN
33,338	66,421	25,357	20,638	25,400	0,38	4T-2585/2520	29	NTN
	68,262	22,225	17,462	22,225	0,37	4T-M88047/M88010	29	NTN
	68,262	22,225	17,462	22,225	0,38	4T-M88048/M88010	29	NTN
	69,012	19,583	15,875	19,845	0,34	4T-14130/14274	29	NTN
	69,012	19,583	15,875	19,845	0,34	4T-14130/14276	29	NTN
	69,012	19,583	15,875	19,845	0,34	4T-14131/14274	29	NTN
	69,012	19,583	15,875	19,845	0,35	4T-14131/14276	29	NTN
	69,850	25,357	19,050	25,357	0,43	4T-2585/2523	29	NTN
	72,626	29,997	23,812	30,162	0,58	4T-3196/3120	29	NTN
	73,025	27,783	23,020	29,370	0,60	4T-HM88547/HM88510	29	NTN
	76,200	25,654	19,050	23,812	0,55	4T-2785/2720	29	NTN
	76,200	25,654	19,050	25,654	0,54	4T-2790/2720	29	NTN
	76,200	28,575	23,020	29,370	0,66	4T-HM89443/HM89410	29	NTN
	76,200	28,575	23,020	29,370	0,67	4T-HM89444/HM89410	29	NTN
	79,375	24,074	17,462	25,400	0,57	4T-43131/43312	29	NTN
	79,375	24,074	17,462	25,400	0,60	4T-43131/43312B	29	NTN
		19,583			0,21	4T-14130	29	NTN
		19,583			0,21	4T-14131	29	NTN
		22,225			0,22	4T-M88047	29	NTN
		22,225			0,23	4T-M88048	29	NTN
		24,074			0,35	4T-43131	29	NTN
		25,357			0,27	4T-2581	29	NTN
		25,357			0,26	4T-2585	29	NTN
	25,654			0,36	4T-2785	29	NTN	
	25,654			0,36	4T-2790	29	NTN	
	27,783			0,36	4T-HM88547	29	NTN	



							 Brands	
d	D	B	C	T	Kg	Reference		
33,338		28,575			0,41	4T-HM89443	29 NTN	
		28,575			0,40	4T-HM89444	29 NTN	
		29,997			0,35	4T-3196	29 NTN	
34,575		28,575			0,39	4T-31594	29 NTN	
34,925	65,088	18,288	13,970	18,034	0,25	4T-LM48548/LM48510	29 NTN	
	65,088	18,288	13,970	18,288	0,25	4T-LM48548A/LM48510	29 NTN	
	65,088	18,288	13,970	18,821	0,26	4T-LM48548L/LM48510	29 NTN	
	69,012	15,583	15,875	19,845	0,33	4T-14137A/14276	29 NTN	
	69,012	19,583	15,875	19,845	0,33	4T-14137A/14274	29 NTN	
	69,012	19,583	15,875	19,845	0,32	4T-14138A/14274	29 NTN	
	69,012	19,583	15,875	19,845	0,33	4T-14138A/14276	29 NTN	
	72,233	25,400	19,842	25,400	0,49	4T-HM88649/HM88610	29 NTN	
	72,238	20,638	15,875	20,638	0,39	4T-16137/16284	29 NTN	
	73,025	22,225	17,462	22,225	0,43	4T-02878/02820	29 NTN	
	73,025	22,225	17,462	23,812	0,42	4T-02877/02820	29 NTN	
	73,025	23,812	17,462	22,225	0,43	4T-2878/2820	29 NTN	
	73,025	24,608	19,050	24,608	0,46	4T-25877/25820	29 NTN	
	73,025	24,608	19,050	24,608	0,47	4T-25877/25821	29 NTN	
	73,025	24,608	19,050	24,608	0,46	4T-25878/25820	29 NTN	
	73,025	25,654	19,050	23,812	0,49	4T-2793/2735X	29 NTN	
	76,200	25,654	19,050	23,812	0,54	4T-2793/2729	29 NTN	
	76,200	25,654	19,050	25,654	0,53	4T-2793/2720	29 NTN	
	76,200	25,654	19,050	25,654	0,53	4T-2796/2720	29 NTN	
	76,200	28,575	23,020	29,370	0,64	4T-HM89446/HM89410	29 NTN	
	76,200	28,575	23,812	29,370	0,63	4T-31593/31520	29 NTN	
	76,200	28,575	23,812	29,370	0,63	4T-31594/31520	29 NTN	
	79,375	29,771	23,812	29,771	0,72	4T-3478/3420	29 NTN	
	80,035	20,940	15,875	21,433	0,47	4T-28137/28317	29 NTN	
	80,167	30,391	23,812	30,391	0,73	4T-3379/3320	29 NTN	
	85,725	30,162	23,812	30,162	0,89	4T-3872/3820	29 NTN	
		18,288				0,16	4T-LM48548L	29 NTN
		18,288				0,16	4T-LM48548	29 NTN
		18,288				0,16	4T-LM48548A	29 NTN
		18,288				0,17	4T-LM48549	29 NTN
		18,288				0,16	4T-LM48549X	29 NTN
		19,583				0,20	4T-14137A	29 NTN
		19,583				0,20	4T-14138A	29 NTN
		20,940				0,27	4T-28137	29 NTN
		22,225				0,26	4T-02877	29 NTN
		22,225				0,27	4T-02878	29 NTN
		23,698				0,38	4T-27875	29 NTN
		23,812				0,28	4T-2878	29 NTN
		24,608				0,30	4T-25877	29 NTN
		24,608				0,30	4T-25878	29 NTN
		25,400				0,30	4T-HM88649	29 NTN
		25,654				0,35	4T-2793	29 NTN
	25,654				0,34	4T-2796	29 NTN	
	26,721				0,23	4T-14136A	29 NTN	
	28,575				0,39	4T-31593	29 NTN	
	28,575				0,39	4T-HM89446	29 NTN	
	29,771				0,47	4T-3478	29 NTN	
	29,771				0,47	4T-3482	29 NTN	
	30,162				0,61	4T-3872	29 NTN	
	30,391				0,52	4T-3379	29 NTN	
	26,721				0,23	4T-14136AA	29 NTN	
34,976	69,012	19,583	15,875	19,845	0,33	4T-14139/14276	29 NTN	
		19,583			0,20	4T-14139	29 NTN	
34,988	59,131	16,764	11,938	16,764	0,17	4T-L68149/L68110	29 NTN	

								Brands
d	D	B	C	T	Kg	Reference		
34,988	59,974	16,764	11,938	16,764	0,18	4T-L68149/L68111	29	NTN
	61,973	17,000	13,600	17,000	0,20	4T-LM78349/LM78310A	29	NTN
		16,764			0,11	4T-L68149	29	NTN
		17,000			0,13	4T-LM78349	29	NTN
		18,460			0,12	4T-JL68145	29	NTN
35,000	55,000	14,000	11,500	14,000	0,12	32907X	29	NTN
	60,000	18,460	11,938	18,410	0,18	4T-JL68145/JL68111Z	29	NTN
	62,000	18,000	14,000	18,000	0,23	32007 C	29	SNR
	62,000	18,000	14,000	18,000	0,22	32007X	29	NTN
	62,000	21,000	17,000	21,000	0,26	33007	29	NTN
	65,000	18,000			0,28	E-CRT0752V	37	NTN
	70,000	23,000	18,500	24,250	0,42	4T-CR-07A14	29	NTN
	72,000	17,000	15,000	18,250	0,34	30207	29	NTN
	72,000	17,000	15,000	18,250	0,35	30207 A	29	SNR
	72,000	23,000	19,000	24,250	0,46	32207	29	NTN
	72,000	23,000	19,000	24,250	0,46	32207 B	29	SNR
	72,000	23,000	19,000	24,250	0,46	32207C	29	NTN
	72,000	23,000	19,000	24,250	0,45	32207 C	29	SNR
	72,000	28,000	22,000	28,000	0,53	33207	29	NTN
	72,000	28,000	22,000	28,000	0,55	33207 A	29	SNR
	79,375	25,400	19,050	25,400	0,60	4T-26883/26822	29	NTN
	80,000	21,000	15,000	22,750	0,52	30307D	29	NTN
	80,000	21,000	15,000	22,750	0,55	31307 A	29	SNR
	80,000	21,000	17,000	22,750	0,52	30307C	29	NTN
	80,000	21,000	18,000	22,750	0,53	30307	29	NTN
	80,000	21,000	18,000	22,750	0,54	30307 A	29	SNR
	80,000	22,403	17,826	22,403	0,53	4T-339/332	29	NTN
	80,000	31,000	25,000	32,750	0,79	32307	29	NTN
	80,000	31,000	25,000	32,750	0,80	32307 A	29	SNR
	80,000	31,000	25,000	32,750	0,80	32307 BC12	29	SNR
	80,000	31,000	25,000	32,750	0,79	32307C	29	NTN
	140,000	76,700			3,92	E-CR1-07A01LL	30	NTN
		22,403			0,39	4T-339	29	NTN
		23,282			0,32	4T-43138X	29	NTN
		25,400			0,42	4T-26883	29	NTN
35,717	72,233	25,400	19,842	25,400	0,48	4T-HM88648/HM88610	29	NTN
	72,626	25,400	19,842	25,400	0,48	4T-HM88648/HM88611AS	29	NTN
		25,400			0,29	4T-HM88648	29	NTN
36,000	120,000	240,000			13,80	CRTD0701	38	NTN
36,487	73,025	24,608	19,050	24,608	0,45	4T-25880/25820	29	NTN
	73,025	24,608	19,050	24,608	0,45	4T-25880/25821	29	NTN
	76,200	25,654	19,050	25,654	0,51	4T-2780/2720	29	NTN
		24,608			0,29	4T-25880	29	NTN
		25,654			0,32	4T-2794	29	NTN
		25,654			0,33	4T-2780	29	NTN
36,512	76,200	28,575	23,020	29,370	0,63	4T-HM89448/HM89410	29	NTN
	76,200	28,575	23,020	29,370	0,62	4T-HM89449/HM89410	29	NTN
	76,200	28,575	23,020	29,370	0,63	4T-HM89449/HM89411	29	NTN
	76,200	28,575	23,812	29,370	0,61	4T-31597/31520	29	NTN
	79,375	28,829	22,664	29,370	0,69	4T-HM89249/HM89210	29	NTN
	79,375	29,771	23,812	29,370	0,71	4T-3479/3420	29	NTN
	88,500	23,698	17,462	25,400	0,73	4T-44143/44348	29	NTN
	93,662	31,750	26,195	31,750	1,15	4T-46143/46368	29	NTN
		23,698			0,48	4T-44143	29	NTN
		28,575			0,37	4T-31597	29	NTN
		28,575			0,37	4T-HM89448	29	NTN
		28,575			0,37	4T-HM89449	29	NTN

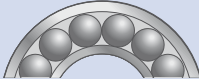

							 Brands	
d	D	B	C	T	Kg	Reference		
36,512		28,829			0,43	4T-HM89249	29 NTN	
		29,771			0,45	4T-3479	29 NTN	
		31,750			0,76	4T-46143	29 NTN	
38,000	63,000	17,000	13,500	17,000	0,20	4T-JL69349/JL69310	29 NTN	
	63,000	17,000	13,500	19,000	0,21	4T-JL69345/JL69310	29 NTN	
	80,000	22,000	16,000	24,000	0,53	4T-CR-08A75	29 NTN	
		17,000			0,13	4T-JL69349	29 NTN	
38,100	63,500	11,908	9,525	12,700	0,15	4T-13889/13830	29 NTN	
	65,088	18,288	13,970	18,034	0,23	4T-LM29748/LM29710	29 NTN	
	65,088	18,288	13,970	18,034	0,23	4T-LM29749/LM29710	29 NTN	
	65,088	18,288	13,970	18,821	0,24	4T-LM29748L/LM29710	29 NTN	
	65,088	18,288	15,748	19,812	0,25	4T-LM29749/LM29711	29 NTN	
	65,088	21,139	13,970	21,139	0,24	4T-CR-0889	29 NTN	
	68,262	16,520	11,908	16,520	0,24	4T-19150/19268	29 NTN	
	69,012	19,050	15,083	19,050	0,29	4T-13685/13620	29 NTN	
	69,012	19,050	15,083	19,050	0,29	4T-13685/13621	29 NTN	
	69,012	19,050	15,083	19,050	0,30	4T-13687/13620	29 NTN	
	69,012	19,050	15,083	19,050	0,30	4T-13687/13621	29 NTN	
	71,438	16,520	11,908	15,875	0,27	4T-19150/19281	29 NTN	
	72,000	16,520	14,288	17,018	0,30	4T-19150/19283X	29 NTN	
	72,000	20,638	14,237	19,000	0,33	4T-16150/16282	29 NTN	
	72,238	20,638	15,875	20,638	0,35	4T-16150/16284	29 NTN	
	72,238	20,638	19,050	23,812	0,39	4T-16150/16283	29 NTN	
	73,025	25,654	19,050	23,812	0,44	4T-2788/2735X	29 NTN	
	76,200	20,940	15,507	20,940	0,40	4T-28150/28300	29 NTN	
	76,200	25,654	19,050	23,812	0,50	4T-2776/2720	29 NTN	
	76,200	25,654	19,050	23,812	0,50	4T-2788/2720	29 NTN	
	76,200	25,654	19,050	25,654	0,49	4T-2788/2729	29 NTN	
	79,375	25,400	19,050	23,812	0,57	4T-26878/26822	29 NTN	
	79,375	29,771	23,812	29,370	0,68	4T-3490/3420	29 NTN	
	80,000	20,940	15,875	21,006	0,47	4T-28150/28315	29 NTN	
	80,000	25,400	19,050	25,400	0,58	4T-26878/26824	29 NTN	
	80,035	23,698	18,512	24,608	0,56	4T-27880/27820	29 NTN	
	80,035	23,698	18,512	24,608	0,56	4T-27881/27820	29 NTN	
	80,167	30,391	23,812	30,391	0,68	4T-3381/3320	29 NTN	
	82,550	28,575	23,020	29,370	0,77	4T-HM801346/HM801310	29 NTN	
	82,550	28,575	23,020	29,370	0,76	4T-HM801346X/HM801310	29 NTN	
	82,931	25,400	19,050	23,812	0,65	4T-25572/25520	29 NTN	
	85,725	30,162	23,812	30,162	0,86	4T-3875/3820	29 NTN	
	85,725	30,162	23,812	30,162	0,85	4T-3876/3820	29 NTN	
	87,312	30,886	23,812	30,162	0,88	4T-3580/3525	29 NTN	
	88,500	29,083	22,225	26,988	0,84	4T-418/414	29 NTN	
	88,501	23,698	17,462	25,400	0,71	4T-44150/44348	29 NTN	
	101,600	58,735				2,77	NA24776SW/K97753ZZ	30 NTN
		11,908				0,10	4T-13889	29 NTN
		16,520				0,17	4T-19150	29 NTN
		18,288				0,16	4T-LM29748L	29 NTN
		18,288				0,15	4T-LM29748	29 NTN
		18,288				0,16	4T-LM29749	29 NTN
	19,050				0,19	4T-13685L	29 NTN	
	19,050				0,19	4T-13685	29 NTN	
	19,050				0,19	4T-13687	29 NTN	
	20,638				0,21	4T-16150	29 NTN	
	20,940				0,26	4T-28150	29 NTN	
	23,698				0,35	4T-27880	29 NTN	
	23,698				0,35	4T-27881	29 NTN	
	23,698				0,47	4T-44150	29 NTN	
	25,400				0,39	4T-26878	29 NTN	
	25,654				0,30	4T-2777	29 NTN	
	25,654				0,31	4T-2788A	29 NTN	





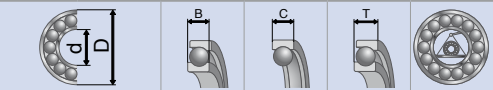
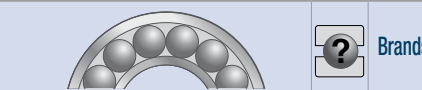

								Brands
d	D	B	C	T	Kg	Reference		
38,100		25,654			0,31	4T-2776	29	NTN
		25,654			0,31	4T-2788	29	NTN
		28,575			0,80	4T-33880	29	NTN
		28,575			0,48	4T-HM801346X	29	NTN
		28,575			0,48	4T-HM801346	29	NTN
		29,083			0,51	4T-418	29	NTN
		29,771			0,42	4T-3490	29	NTN
		30,162			0,57	4T-3876	29	NTN
		30,162			0,57	4T-3875	29	NTN
		30,391			0,47	4T-3381	29	NTN
		30,886			0,57	4T-3583	29	NTN
		36,068			1,01	4T-525	29	NTN
		40,386			0,86	4T-4375	29	NTN
	38,112		25,400			0,44	4T-25572	29
		26,195			0,25	4T-13686	29	NTN
39,688	73,025	22,098	21,336	25,654	0,43	4T-M201047/M201011	29	NTN
	76,200	25,654	19,050	25,654	0,47	4T-2789/2720	29	NTN
	76,200	25,654	19,050	25,654	0,47	4T-2789/2729	29	NTN
	77,534	30,391	23,812	29,370	0,67	4T-3382/3321	29	NTN
	79,375	25,400	19,050	23,812	0,55	4T-26880/26822	29	NTN
	79,375	25,400	19,050	25,400	0,55	4T-26881/26822	29	NTN
	79,975	30,391	23,812	29,370	0,67	4T-3386/3325	29	NTN
	80,035	30,391	23,812	29,370	0,67	4T-3382/3339	29	NTN
	80,167	30,391	23,812	30,391	0,66	4T-3382/3320	29	NTN
	80,167	30,391	23,812	30,391	0,66	4T-3386/3320	29	NTN
	80,167	32,941	23,812	29,370	0,67	4T-CR-08A86	29	NTN
	88,500	23,698	17,462	25,400	0,69	4T-44158/44348	29	NTN
		22,098			0,26	4T-M201047S	29	NTN
		22,098			0,26	4T-M201047	29	NTN
		25,400			0,37	4T-26880	29	NTN
		25,400			0,37	4T-26881	29	NTN
		25,654			0,29	4T-2789	29	NTN
		30,302			0,56	4T-3774	29	NTN
		30,391			0,45	4T-3382	29	NTN
		30,391			0,45	4T-3386	29	NTN
39,980		19,649			0,23	4T-28156	29	NTN
40,000	62,000	15,000	12,000	15,000	0,16	32908X	29	NTN
	68,000	19,000	14,500	19,000	0,27	32008 C	29	SNR
	68,000	19,000	14,500	19,000	0,27	32008X	29	NTN
	68,000	19,000	17,500	22,000	0,29	4T-CR-0891	29	NTN
	68,000	22,000	18,000	22,000	0,31	33008	29	NTN
	75,000	26,000	20,500	26,000	0,49	33108	29	NTN
	75,000	26,000	20,500	26,000	0,52	33108 A	29	SNR
	76,200	17,384	14,288	18,009	0,33	4T-CR-0898	29	NTN
	76,200	20,940	15,507	20,940	0,38	4T-28158/28300	29	NTN
	80,000	18,000	16,000	19,750	0,44	30208	29	NTN
	80,000	18,000	16,000	19,750	0,44	30208 A	29	SNR
	80,000	22,403	17,826	22,403	0,48	4T-344/332	29	NTN
	80,000	22,403	17,826	22,403	0,48	4T-344A/332	29	NTN
	80,000	23,000	19,000	24,750	0,56	32208	29	NTN
	80,000	23,000	19,000	24,750	0,53	32208 C	29	SNR
	80,000	29,000	23,000	30,000	0,66	CR-0864	29	NTN
	80,000	32,000	25,000	32,000	0,73	33208	29	NTN
	80,000	32,000	25,000	32,000	0,76	33208 A	29	SNR
	80,000	45,000			0,93	4T-430208X	30	NTN
	80,000	45,000			18,00	430208XU	30	NTN
	80,000	55,000			1,18	4T-432208X	30	NTN
	80,000	55,000			1,16	432208XU	30	NTN
	85,000	19,000	16,000	20,750	0,56	4T-CR-08A37	29	NTN







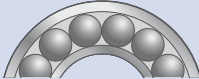

							
d	D	B	C	T	Kg	Reference	Brands
40,000	85,000	21,692	17,462	20,638	0,56	4T-350A/354A	29 NTN
	85,000	21,692	17,462	21,692	0,56	4T-357/354A	29 NTN
	85,000	32,500	28,000	33,000	0,91	4T-T2EE040	29 NTN
	86,000	47,000			1,20	E-CR1-0874	30 NTN
	88,500	29,083	22,225	26,988	0,81	4T-420/414	29 NTN
	90,000	23,000	17,000	25,250	0,74	30308D	29 NTN
	90,000	23,000	17,000	25,250	0,76	31308 A	29 SNR
	90,000	23,000	19,000	25,250	0,73	30308C	29 NTN
	90,000	23,000	20,000	25,250	0,77	30308	29 NTN
	90,000	23,000	20,000	25,250	0,78	30308 A	29 SNR
	90,000	33,000	27,000	35,250	1,06	32308	29 NTN
	90,000	33,000	27,000	35,250	1,04	32308 A	29 SNR
	90,000	33,000	27,000	35,250	1,04	32308 BC12	29 SNR
	90,000	33,000	27,000	35,250	1,10	32308C	29 NTN
	90,000	50,500			1,49	4T-30308DDF	30 NTN
	90,000	56,000			1,61	4T-430308	30 NTN
	90,000	56,000			1,56	4T-430308DX	30 NTN
	90,000	56,000			1,61	430308U	30 NTN
	90,000			23,250	0,70	4T-CR-08B01	29 NTN
	107,950	36,957	28,575	36,957	1,76	4T-543/532X	29 NTN
	111,000	48,000			2,26	E-CR1-0875	30 NTN
		20,940			0,25	4T-28158	29 NTN
		21,692			0,40	4T-357	29 NTN
	22,403			0,34	4T-344A	29 NTN	
	29,083			0,48	4T-420	29 NTN	
40,483	82,550	28,575	23,020	29,370	0,73	4T-HM801349/HM801310	29 NTN
		28,575			0,44	4T-HM801349	29 NTN
41,000	68,000	18,000	13,500	18,000	0,24	4T-LM300849/LM300811	29 NTN
	78,000	18,000	13,500	18,000	0,36	4T-CR-0880	29 NTN
		18,000			0,16	4T-LM300849	29 NTN
41,275	73,025	17,462	12,700	17,462	0,28	4T-18590/18520	29 NTN
	73,431	19,812	14,732	19,558	0,34	4T-LM501349/LM501310	29 NTN
	73,431	19,812	14,732	19,558	0,34	4T-LM501349A/LM501310	29 NTN
	73,431	19,812	16,604	21,430	0,35	4T-LM501349/LM501314	29 NTN
	73,431	19,812	18,186	23,012	0,37	4T-LM501349/LM501311	29 NTN
	76,200	17,384	14,288	18,009	0,34	4T-11162/11300	29 NTN
	76,200	23,020	17,462	23,020	0,43	4T-24780/24720	29 NTN
	76,200	23,020	20,638	25,400	0,47	4T-24780/24721	29 NTN
	76,200	25,400	20,638	25,400	0,49	4T-26882/26823	29 NTN
	79,375	25,400	19,050	23,812	0,54	4T-26885/26822	29 NTN
	79,375	25,400	19,050	25,400	0,53	4T-26882/26822	29 NTN
	79,375	25,400	19,050	25,400	0,71	4T-26882T/26822	29 NTN
	80,000	17,384	14,288	18,009	0,39	4T-11162/11315	29 NTN
	80,000	22,403	17,826	22,403	0,47	4T-336/332	29 NTN
	80,000	25,400	19,050	23,812	0,54	4T-26882/26824	29 NTN
	80,167	25,400	20,638	25,400	0,56	4T-26882/26820	29 NTN
	80,167	30,391	23,812	30,391	0,64	4T-3384/3320	29 NTN
	82,550	25,654	20,193	26,543	0,64	4T-M802048/M802011	29 NTN
	85,725	30,162	23,812	30,162	0,79	4T-3877/3820	29 NTN
	85,725	30,162	23,812	30,162	0,81	4T-3880/3820	29 NTN
	87,312	30,886	23,812	30,162	0,83	4T-3576/3525	29 NTN
	87,312	30,886	23,812	30,886	0,82	4T-3577/3525	29 NTN
	87,312	30,886	23,812	30,886	0,83	4T-3585/3525	29 NTN
	88,500	23,698	17,462	25,400	0,67	4T-44162/44348	29 NTN
	88,900	29,370	23,020	30,162	0,90	4T-HM803145/HM803110	29 NTN
	88,900	29,370	23,020	30,162	0,89	4T-HM803146/HM803110	29 NTN
	90,488	40,386	33,338	40,386	1,25	4T-4388/4335	29 NTN
	92,075	23,812	16,670	26,195	0,76	4T-M903345/M903310	29 NTN
	93,662	31,750	25,400	31,750	1,05	4T-49162/49368	29 NTN

								Brands	
d	D	B	C	T	Kg	Reference			
41,275	93,662	31,750	26,195	31,750	1,09	4T-46162/46368	29	NTN	
	95,250	28,300	20,638	30,958	0,98	4T-53162/53375	29	NTN	
	95,250	28,575	22,225	30,958	1,03	4T-HM903245/HM903210	29	NTN	
	95,250	29,370	23,020	30,162	1,08	4T-HM804840/HM804810	29	NTN	
	101,600	36,068	26,988	36,068	1,42	4T-526/522	29	NTN	
	104,775	36,512	28,575	36,512	1,62	4T-59162/59412	29	NTN	
		17,384				0,21	4T-11162	29	NTN
		17,462				0,20	4T-18590	29	NTN
		19,812				0,22	4T-LM501349	29	NTN
		22,403				0,33	4T-336	29	NTN
		22,403				0,31	4T-342	29	NTN
		23,020				0,28	4T-24780	29	NTN
		23,698				0,43	4T-44162	29	NTN
		23,812				0,51	4T-M903345	29	NTN
		25,400				0,36	4T-26882T	29	NTN
		25,400				0,34	4T-26882	29	NTN
		25,654				0,41	4T-M802048	29	NTN
		28,300				0,61	4T-53162	29	NTN
		28,300				0,65	4T-HM903244	29	NTN
		28,575				0,65	4T-HM903245	29	NTN
		29,370				0,57	4T-HM803146	29	NTN
		29,370				0,72	4T-HM804840	29	NTN
		29,977				0,40	4T-342A	29	NTN
		30,391				0,43	4T-3384	29	NTN
		30,886				0,52	4T-3577	29	NTN
		30,886				0,53	4T-3585	29	NTN
		31,750				0,69	4T-49162	29	NTN
		31,750				0,68	4T-46162	29	NTN
		36,068				1,01	4T-526	29	NTN
		36,512				1,15	4T-59162	29	NTN
	40,386				0,79	4T-4388	29	NTN	
41,288		30,162			0,52	4T-3880	29	NTN	
		30,162			0,52	4T-3877	29	NTN	
		30,467			0,42	4T-3383	29	NTN	
42,070	90,488	40,386	33,338	39,688	1,24	4T-4395/4335	29	NTN	
42,862	82,550	26,988	20,638	26,988	0,61	4T-22780/22720	29	NTN	
	82,931	25,400	19,050	23,812	0,58	4T-25578/25520	29	NTN	
	87,312	30,886	23,812	30,162	0,81	4T-3579/3525	29	NTN	
		25,400			0,38	4T-25578	29	NTN	
		26,988			0,39	4T-22780	29	NTN	
		30,886			0,50	4T-3579	29	NTN	
42,875	79,375	25,400	19,050	25,400	0,51	4T-26884/26822	29	NTN	
	80,000	22,403	17,826	22,403	0,45	4T-342S/332	29	NTN	
	80,000	25,400	19,050	23,812	0,53	4T-26886/26824	29	NTN	
	80,000	25,400	19,050	25,400	0,52	4T-26884/26824	29	NTN	
	80,167	25,400	20,638	25,400	0,55	4T-26886/26830	29	NTN	
	82,931	25,400	19,050	25,400	0,58	4T-25577/25520	29	NTN	
	82,931	25,400	22,225	26,988	0,62	4T-25577/25523	29	NTN	
	83,058	25,400	19,050	25,400	0,57	4T-25577/25521	29	NTN	
	83,058	25,400	19,114	25,400	0,58	4T-25577/25522	29	NTN	
		22,403			0,31	4T-342S	29	NTN	
		25,400			0,38	4T-25577	29	NTN	
		25,400			0,32	4T-26884	29	NTN	
		25,400			0,33	4T-26886	29	NTN	
	44,450	76,992	17,145	11,908	17,462	0,31	4T-12175/12303	29	NTN
		79,375	17,462	13,495	17,462	0,35	4T-18685/18620	29	NTN
82,931		25,400	19,050	23,812	0,56	4T-25582/25520	29	NTN	





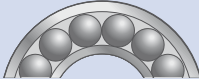



							 Brands	
d	D	B	C	T	Kg	Reference		
44,450	82,931	25,400	19,050	25,400	0,56	4T-25580/25520	29 NTN	
	82,931	25,400	22,225	26,988	0,60	4T-25580/25523	29 NTN	
	82,931	25,476	19,050	25,400	0,56	4T-25581/25520	29 NTN	
	83,058	25,400	19,050	25,400	0,55	4T-25580/25521	29 NTN	
	83,058	25,400	19,114	25,400	0,56	4T-25580/25522	29 NTN	
	84,138	30,886	23,812	30,162	0,70	4T-3578/3520	29 NTN	
	85,000	21,692	17,462	20,638	0,51	4T-355/354A	29 NTN	
	85,000	21,692	17,462	20,638	0,50	4T-355X/354X	29 NTN	
	87,312	30,886	23,812	30,886	0,76	4T-3578/3525	29 NTN	
	88,500	40,386	33,338	40,386	1,12	4T-4370/4320	29 NTN	
	88,900	29,370	23,020	30,162	0,86	4T-CR-09A47	29 NTN	
	88,900	29,370	23,020	30,162	0,85	4T-HM803149/HM803110	29 NTN	
	88,900	29,370	23,020	30,162	0,85	4T-HM803149/HM803111	29 NTN	
	90,119	21,692	21,808	23,000	0,66	4T-355X/352	29 NTN	
	92,075	29,370	23,020	30,162	0,92	4T-HM803149/HM803112	29 NTN	
	93,264	30,302	23,812	30,302	0,95	4T-3782/3720	29 NTN	
	93,662	31,750	26,195	31,750	1,04	4T-46175/46368	29 NTN	
	95,250	28,300	20,638	30,958	0,93	4T-53176/53375	29 NTN	
	95,250	28,300	20,638	30,958	0,92	4T-53177/53375	29 NTN	
	95,250	28,300	20,638	30,958	0,93	4T-53178/53375	29 NTN	
	95,250	28,575	22,225	27,783	0,99	4T-33885/33821	29 NTN	
	95,250	28,575	22,225	28,575	0,98	4T-33885/33822	29 NTN	
	95,250	28,575	22,225	30,958	0,99	4T-HM903249/HM903210	29 NTN	
	95,250	29,370	23,020	30,162	1,04	4T-HM804842/HM804810	29 NTN	
	95,250	29,370	23,020	30,162	1,02	4T-HM804843/HM804810	29 NTN	
	95,250	29,900	22,225	27,783	0,95	4T-438/432	29 NTN	
	101,600	36,068	26,988	36,068	1,36	4T-527/522	29 NTN	
	104,775	29,371	24,605	30,162	1,29	4T-460/453X	29 NTN	
	104,775	30,958	23,812	30,162	1,35	4T-45280/45220	29 NTN	
	104,775	36,512	28,575	36,512	1,56	4T-59175/59412	29 NTN	
	104,775	36,512	28,575	36,512	1,62	4T-HM807040/HM807010	29 NTN	
	111,125	26,909	20,638	30,162	1,45	4T-55175C/55437	29 NTN	
	111,125	26,909	20,638	30,162	1,35	4T-55176/55437	29 NTN	
	111,125	26,909	20,638	30,162	1,09	4T-55176C/55437	29 NTN	
	111,125	36,957	30,162	38,100	1,84	4T-535/532A	29 NTN	
	112,712	26,909	20,638	30,162	1,40	4T-55176/55443	29 NTN	
	114,300	44,450	34,925	44,450	2,32	4T-65385/65320	29 NTN	
	127,000	52,388	41,275	52,388	3,60	4T-6277/6220	29 NTN	
		17,145				0,21	4T-12175	29 NTN
		17,462				0,22	4T-18685	29 NTN
		21,692				0,35	4T-355	29 NTN
		21,692				0,34	4T-355X	29 NTN
		25,400				0,35	4T-25580	29 NTN
		26,909				0,93	4T-55175C	29 NTN
	26,909				0,85	4T-55176	29 NTN	
	28,300				0,56	4T-53178	29 NTN	
	28,300				0,56	4T-53176	29 NTN	
	28,300				0,56	4T-53177	29 NTN	
	28,300				0,61	4T-HM903247	29 NTN	
	28,575				0,61	4T-HM903249	29 NTN	
	29,370				0,53	4T-HM803149	29 NTN	
	29,370				0,68	4T-HM804842	29 NTN	
	29,370				0,67	4T-HM804843	29 NTN	
	29,371				0,92	4T-460	29 NTN	
	29,900				0,57	4T-438	29 NTN	
	30,302				0,66	4T-3782	29 NTN	
	30,886				0,47	4T-3578A	29 NTN	
	30,886				0,47	4T-3578	29 NTN	
	30,958				0,99	4T-45280	29 NTN	
	31,354				0,40	4T-17888	29 NTN	
	31,750				0,64	4T-49175	29 NTN	
	31,750				0,63	4T-46176	29 NTN	

								Brands
d	D	B	C	T	Kg	Reference		
44,450		35,878			0,44	4T-25583	29	NTN
		36,068			0,95	4T-527	29	NTN
		36,512			1,09	4T-59175	29	NTN
		36,512			1,12	4T-HM807040	29	NTN
		36,957			1,10	4T-535	29	NTN
		44,450			1,46	4T-65385	29	NTN
		52,388			2,34	4T-6277	29	NTN
44,463		21,692			0,34	4T-355A	29	NTN
		25,476			0,36	4T-25581	29	NTN
		28,575			0,72	4T-33885	29	NTN
44,983	82,931	25,400	19,050	25,400	0,55	4T-25584/25520	29	NTN
	83,058	25,400	19,050	25,400	0,55	4T-25584/25521	29	NTN
	93,264	30,302	23,812	30,302	0,94	4T-3776/3720	29	NTN
		25,400			0,35	4T-25584	29	NTN
		30,302			0,65	4T-3776	29	NTN
44,988	95,250	28,575	22,225	30,958	0,98	4T-HM903248/HM903210	29	NTN
45,000	68,000	15,000	12,000	15,000	0,18	32909X	29	NTN
	75,000	2,000	15,500	20,000	0,33	32009X	29	NTN
	75,000	20,000	17,700	22,200	0,36	4T-CR-09B11	29	NTN
	75,000	24,000	19,000	24,000	0,40	33009	29	NTN
	76,000	22,000			0,42	E-CRT0953V	37	NTN
	80,000	26,000	20,500	26,000	0,54	33109	29	NTN
	80,000	26,000	20,500	26,000	0,55	33109 A	29	SNR
	85,000	19,000	16,000	20,750	0,49	30209	29	NTN
	85,000	19,000	16,000	20,750	0,48	30209 C	29	SNR
	85,000	21,692	17,462	20,638	0,51	4T-358/354A	29	NTN
	85,000	21,692	17,462	21,692	0,50	4T-358X/354A	29	NTN
	85,000	23,000	19,000	24,750	0,59	32209	29	NTN
	85,000	23,000	19,000	24,750	0,60	32209 A	29	SNR
	85,000	23,000	19,000	24,750	0,61	32209 BA	29	SNR
	85,000	32,000	25,000	32,000	0,79	33209	29	NTN
	85,000	32,000	25,000	32,000	0,80	33209 A	29	SNR
	85,000	41,500			1,02	4T-30209DF	30	NTN
	85,000	47,000			1,04	4T-430209	30	NTN
	85,000	47,000			1,06	430209U	30	NTN
	85,000	55,000			1,27	4T-432209	30	NTN
	85,000	55,000			1,27	432209U	30	NTN
	88,900	22,225	16,513	20,638	0,60	4T-367/362A	29	NTN
	90,000	29,000	20,000	29,000	0,82	CR-0996	29	NTN
	95,000	26,500	20,000	29,000	0,90	4T-T7FC045	29	NTN
	100,000	25,000	18,000	27,250	0,96	30309D	29	NTN
	100,000	25,000	18,000	27,250	0,96	31309 A	29	SNR
	100,000	25,000	22,000	27,250	1,00	30309	29	NTN
	100,000	25,000	22,000	27,250	1,00	30309 A	29	SNR
	100,000	36,000	30,000	38,250	1,43	32309	29	NTN
	100,000	36,000	30,000	38,250	1,49	32309 A	29	SNR
	100,000	36,000	30,000	38,250	1,51	32309 BA	29	SNR
	100,000	36,000	30,000	38,250	1,45	32309C	29	NTN
	100,000	54,500			2,00	4T-30309DDF	30	NTN
	100,000	60,000			2,11	4T-430309	30	NTN
	104,986	31,750	23,368	32,512	1,34	4T-HM905843/HM905810	29	NTN
	21,692			0,34	4T-358X	29	NTN	
	22,225			0,36	4T-367	29	NTN	
	23,950			0,25	4T-JLM603048	29	NTN	
	31,750			0,85	4T-HM905843	29	NTN	
45,230	79,985	20,638	15,080	19,842	0,40	4T-17887/17831SA	29	NTN
	79,985	20,638	15,080	20,638	0,40	4T-17887/17831	29	NTN

							 Brands
d	D	B	C	T	Kg	Reference	
45,230		20,638			0,27	4T-17887SA	29 NTN
		20,638			0,27	4T-17887	29 NTN
45,237	87,312	30,886	23,812	30,162	0,77	4T-3586/3525	29 NTN
		30,886			0,46	4T-3586	29 NTN
45,242	73,431	19,812	15,748	19,812	0,31	4T-LM102949/LM102910	29 NTN
	77,788	19,842	15,080	19,842	0,37	4T-LM603049/LM603011	29 NTN
	77,788	19,842	16,667	21,430	0,39	4T-LM603049/LM603012	29 NTN
	80,000	19,842	15,080	19,842	0,39	4T-LM603049/LM603014	29 NTN
		19,812			0,20	4T-LM102949	29 NTN
		19,842			0,24	4T-LM603049JX	29 NTN
		19,842			0,25	4T-LM603049	29 NTN
45,618	82,550	25,400	19,050	23,812	0,53	4T-25590/25519	29 NTN
	82,931	25,400	19,050	25,400	0,54	4T-25590/25520	29 NTN
	82,931	25,400	22,225	26,988	0,56	4T-25590/25523	29 NTN
	83,058	25,400	19,050	25,400	0,53	4T-25590/25521	29 NTN
	83,058	25,400	19,114	23,876	0,55	4T-25590/25522	29 NTN
	85,000	25,400	19,050	23,812	0,58	4T-25590/25526	29 NTN
		25,400			0,34	4T-25590	29 NTN
46,000	75,000	18,000	14,000	18,000	0,29	4T-LM503349/LM503310	29 NTN
	75,000	18,000	14,000	18,000	0,29	4T-LM503349A/LM503310	29 NTN
	91,000	32,000	26,500	32,000	0,92	4T-HM204049/HM204010	29 NTN
		18,000			0,20	4T-LM503349	29 NTN
		18,000			0,20	4T-LM503349A	29 NTN
		32,000			0,62	4T-HM204049	29 NTN
46,038	79,375	17,462	13,495	17,462	0,33	4T-18690/18620	29 NTN
	82,931	25,400	19,050	23,812	0,54	4T-25592/25520	29 NTN
	85,000	21,692	17,462	20,638	0,49	4T-359A/354A	29 NTN
	85,000	21,692	17,462	21,692	0,49	4T-359S/354A	29 NTN
	85,000	21,692	17,462	21,692	0,49	4T-359S/354X	29 NTN
	85,000	25,608	20,638	25,608	0,61	4T-2984/2924	29 NTN
	90,119	21,692	21,808	23,000	0,65	4T-359S/352	29 NTN
	93,264	30,302	23,812	30,162	0,93	4T-3777/3720	29 NTN
	95,250	29,900	22,225	27,783	0,93	4T-436/432	29 NTN
		17,462			0,21	4T-18690	29 NTN
		17,462			0,29	4T-18780	29 NTN
		21,692			0,31	4T-359A	29 NTN
		21,692			0,33	4T-359S	29 NTN
		25,608			0,39	4T-2984	29 NTN
		29,900			0,54	4T-436	29 NTN
47,625	88,900	22,225	16,513	20,638	0,56	4T-369A/362A	29 NTN
	88,900	22,225	16,513	22,225	0,56	4T-369S/362A	29 NTN
	88,900	25,400	19,050	25,400	0,66	4T-M804048/M804010	29 NTN
	88,900	25,400	19,050	25,400	0,65	4T-M804049/M804010	29 NTN
	93,264	30,302	23,812	30,162	0,90	4T-3778/3720	29 NTN
	93,264	30,302	23,812	30,302	0,89	4T-3779/3720	29 NTN
	95,250	29,370	23,020	30,162	0,98	4T-HM804846/HM804810	29 NTN
	96,838	21,946	15,875	21,946	0,71	4T-386A/382A	29 NTN
	100,000	29,370	23,020	30,162	1,11	4T-CR-10A28	29 NTN
	101,600	36,068	26,988	36,068	1,29	4T-528/522	29 NTN
	104,775	29,317	24,605	30,162	1,24	4T-463/453X	29 NTN
	104,775	30,958	23,812	30,162	1,29	4T-45282/45220	29 NTN
	107,950	36,957	28,575	36,957	1,61	4T-536/532X	29 NTN
	111,125	26,909	20,638	30,162	1,31	4T-55187/55437	29 NTN
	111,125	26,909	20,638	30,162	1,40	4T-55187C/55437	29 NTN
	112,712	26,909	20,638	30,162	1,35	4T-55187/55443	29 NTN
	112,712	26,909	20,638	30,162	1,43	4T-55187C/55443	29 NTN



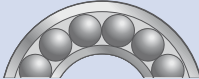



								Brands
d	D	B	C	T	Kg	Reference		
47,625	123,825	32,791	25,400	36,512	2,14	4T-72188C/72487	29	NTN
		21,946			0,54	4T-386A	29	NTN
		22,225			0,39	4T-369A	29	NTN
		22,225			0,40	4T-369S	29	NTN
		25,400			0,44	4T-M804048	29	NTN
		25,400			0,44	4T-M804049	29	NTN
		26,909			0,80	4T-55187	29	NTN
		26,909			0,88	4T-55187C	29	NTN
		29,317			0,86	4T-467	29	NTN
		29,370			0,62	4T-HM804846	29	NTN
		30,302			0,60	4T-3778	29	NTN
		30,302			0,61	4T-3779	29	NTN
		30,958			0,93	4T-45282	29	NTN
		32,791			1,36	4T-72188C	29	NTN
		36,068			0,89	4T-528	29	NTN
		36,957			1,04	4T-536	29	NTN
48,412	95,250	29,370	23,020	30,162	0,97	4T-HM804848/HM804810	29	NTN
	95,250	29,370	23,020	30,162	0,96	4T-HM804849/HM804810	29	NTN
		29,370			0,61	4T-HM804848	29	NTN
		29,370			0,61	4T-HM804849	29	NTN
49,212	93,264	30,302	23,812	30,162	0,88	4T-3781/3720	29	NTN
	103,188	44,475	36,512	43,658	1,75	4T-5395/5335	29	NTN
	104,775	36,512	28,575	36,512	1,52	4T-HM807044/HM807010	29	NTN
	114,300	44,450	34,925	44,450	2,23	4T-65390/65320	29	NTN
	114,300	44,450	36,068	44,450	2,33	4T-HH506348/HH506310	29	NTN
		30,302			0,58	4T-3781	29	NTN
		36,512			1,01	4T-HM807044	29	NTN
		44,450			1,47	4T-HH506348	29	NTN
		44,450			1,33	4T-65390	29	NTN
		44,475			1,11	4T-5395	29	NTN
49,987	82,550	22,225	16,510	21,590	0,43	4T-LM104947A/LM104911	29	NTN
		25,400			0,46	4T-28579	29	NTN
50,000	80,000	20,000	15,500	20,000	0,36	32010 A	29	SNR
	80,000	20,000	15,500	20,000	0,37	32010X	29	NTN
	80,000	24,000	19,000	24,000	0,44	33010	29	NTN
	82,000	21,500	17,000	21,500	0,42	4T-JLM104948/JLM104910	29	NTN
	82,000	22,000			0,47	E-CRT1053V	37	NTN
	84,000	22,000	17,500	22,000	0,46	4T-JLM704649/JLM704610	29	NTN
	85,000	26,000	20,000	26,000	0,58	33110	29	NTN
	85,000	26,000	20,000	26,000	0,61	33110 A	29	SNR
	88,900	22,225	16,513	20,638	0,53	4T-365/362A	29	NTN
	88,900	22,225	16,513	20,638	0,53	4T-366/362A	29	NTN
	90,000	20,000	17,000	21,750	0,55	30210	29	NTN
	90,000	20,000	17,000	21,750	0,55	30210 C	29	SNR
	90,000	22,225	15,875	22,225	0,54	4T-365/362	29	NTN
	90,000	23,000	19,000	24,750	0,65	32210	29	NTN
	90,000	23,000	19,000	24,750	0,65	32210 A	29	SNR
	90,000	28,000	23,000	28,000	0,74	4T-CR-10A62	29	NTN
	90,000	28,000	23,000	28,000	0,75	4T-JM205149/JM205110	29	NTN
	90,000	32,000	24,500	32,000	0,85	33210	29	NTN
	90,000	32,000	24,500	32,000	0,89	33210 A	29	SNR
	90,000	49,000			1,18	4T-430210	30	NTN
	90,000	49,000			1,18	430210U	30	NTN
	90,000	55,000			1,36	432210U	30	NTN
	93,264	30,302	23,812	30,302	0,86	4T-CR-1084	29	NTN
	100,000	35,000	30,000	36,000	1,31	4T-T2ED050	29	NTN
	105,000	29,000	22,000	32,000	1,21	4T-T7FC050	29	NTN
	105,000	36,000	29,000	37,000	1,52	4T-JHM807045/JHM807012	29	NTN



							 Brands	
d	D	B	C	T	Kg	Reference		
50,000	110,000	21,996	18,824	22,000	1,06	4T-396/394A	29 NTN	
	110,000	27,000	19,000	29,250	1,21	4T-CR-10A33	29 NTN	
	110,000	27,000	19,000	29,250	1,25	30310D	29 NTN	
	110,000	27,000	19,000	29,250	1,24	31310 A	29 SNR	
	110,000	27,000	23,000	29,250	1,29	30310	29 NTN	
	110,000	27,000	23,000	29,250	1,29	30310 A	29 SNR	
	110,000	40,000	33,000	42,250	1,90	32310	29 NTN	
	110,000	40,000	33,000	42,250	1,90	32310 A	29 SNR	
	110,000	40,000	33,000	42,250	1,95	32310C	29 NTN	
	110,000	58,500			2,59	4T-30310DDF	30 NTN	
	110,000	64,000			2,72	4T-430310	30 NTN	
	110,000	64,000			2,65	4T-430310DX	30 NTN	
	110,000	64,000			2,76	430310U	30 NTN	
	110,000	90,000			3,98	432310U	30 NTN	
	180,000	135,000			17,80	CRD-1052	31 NTN	
		21,500			0,29	4T-JLM104948	29 NTN	
		21,996			0,80	4T-396	29 NTN	
		22,000			0,30	4T-JLM704649	29 NTN	
		22,225			0,36	4T-365	29 NTN	
		22,225			0,36	4T-366	29 NTN	
		28,000			0,51	4T-JM205149	29 NTN	
		28,000			0,50	4T-JM205149A	29 NTN	
		36,000			1,00	4T-JHM807045	29 NTN	
	50,800	82,550	22,225	16,510	21,590	0,42	4T-LM104949/LM104911	29 NTN
		82,931	22,225	16,510	22,225	0,42	4T-LM104949/LM104912	29 NTN
85,000		17,462	13,495	17,462	0,37	4T-18790/18720	29 NTN	
88,900		17,462	13,495	17,462	0,43	4T-18790/18724	29 NTN	
88,900		22,225	16,513	20,638	0,52	4T-368/362A	29 NTN	
88,900		22,225	16,513	20,638	0,51	4T-370A/362A	29 NTN	
88,900		22,225	16,513	22,225	0,51	4T-368A/362A	29 NTN	
89,980		25,400	19,987	25,400	0,65	4T-28580/28520	29 NTN	
90,000		22,225	15,875	20,000	0,52	4T-368A/362	29 NTN	
90,000		22,225	15,875	22,225	0,52	4T-368/362	29 NTN	
90,000		22,225	20,000	22,225	0,55	4T-368A/363	29 NTN	
92,075		25,400	19,845	25,400	0,70	4T-28580/28521	29 NTN	
93,264		30,302	23,812	30,162	0,85	4T-3775/3720	29 NTN	
93,264		30,302	23,812	30,162	0,85	4T-3780/3720	29 NTN	
93,264		30,302	23,812	30,302	0,83	4T-3784/3720	29 NTN	
95,250		28,575	22,225	28,575	0,86	4T-33889/33821	29 NTN	
95,250		28,575	22,225	28,575	0,87	4T-33889/33822	29 NTN	
95,250		30,302	23,812	30,162	0,90	4T-3780/3726	29 NTN	
96,838		21,946	15,875	21,000	0,68	4T-385A/382A	29 NTN	
97,630		24,608	19,446	24,608	0,85	4T-28678/28622	29 NTN	
98,425		30,302	23,812	30,162	0,99	4T-3780/3732	29 NTN	
101,600		31,750	25,400	31,750	1,13	4T-49585/49520	29 NTN	
101,600		36,068	26,988	36,068	1,23	4T-529/522	29 NTN	
101,600		36,068	26,988	36,068	1,22	4T-529X/522	29 NTN	
104,775		29,317	24,605	30,162	1,19	4T-455/453X	29 NTN	
104,775		30,958	23,812	30,162	1,20	4T-45284/45220	29 NTN	
104,775		30,958	23,812	30,162	1,22	4T-45285/45220	29 NTN	
104,775		30,958	23,812	30,958	1,30	4T-CR-1091	29 NTN	
104,775		36,512	28,575	36,512	1,49	4T-HM807046/HM807010	29 NTN	
104,775		40,157	33,338	39,688	1,62	4T-4580/4535	29 NTN	
107,950		36,957	28,575	36,957	1,53	4T-537/532X	29 NTN	
110,231		30,958	23,812	30,162	1,26	4T-45285A/45220B	29 NTN	
111,125		26,909	20,638	30,162	1,33	4T-55200C/55437	29 NTN	
111,125		28,575	20,638	30,162	1,36	4T-HM907643/HM907614	29 NTN	
112,712		26,909	20,638	30,162	1,34	4T-55200C/55443	29 NTN	
112,712		30,048	23,812	30,162	1,53	4T-3975/3920	29 NTN	
112,712		30,162	23,812	30,162	1,25	4T-39573/39520	29 NTN	
112,712		30,162	23,812	30,162	1,54	4T-39575/39520	29 NTN	



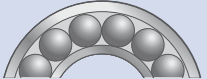



								Brands	
d	D	B	C	T	Kg	Reference			
50,800	117,475	31,750	23,812	33,338	1,67	4T-66200/66462	29	NTN	
	120,650	41,275	31,750	41,275	2,30	4T-619/612	29	NTN	
	123,825	32,791	25,400	36,512	2,08	4T-72200C/72487	29	NTN	
	123,825	36,678	30,162	38,100	2,34	4T-555/552A	29	NTN	
	127,000	44,450	34,925	44,450	2,85	4T-65200/65500	29	NTN	
		17,462				0,24	4T-18790	29	NTN
		21,946				0,49	4T-385A	29	NTN
		22,225				0,28	4T-LM104949	29	NTN
		22,225				0,35	4T-368	29	NTN
		22,225				0,35	4T-368A	29	NTN
		22,225				0,34	4T-370A	29	NTN
		24,608				0,58	4T-28678	29	NTN
		25,400				0,45	4T-28580	29	NTN
		26,909				0,84	4T-55200C	29	NTN
		28,575				0,60	4T-33889	29	NTN
		28,575				0,85	4T-HM907643	29	NTN
		29,317				0,81	4T-455	29	NTN
		30,162				0,89	4T-39573	29	NTN
		30,302				0,55	4T-3775	29	NTN
		30,302				0,55	4T-3780	29	NTN
		30,302				0,54	4T-3784	29	NTN
		30,302				0,55	4T-3795	29	NTN
		30,958				0,86	4T-45284	29	NTN
		30,958				0,88	4T-45285	29	NTN
		31,750				0,74	4T-49585	29	NTN
		31,750				1,11	4T-66200	29	NTN
		32,791				1,30	4T-72200C	29	NTN
		36,068				0,82	4T-529	29	NTN
		36,068				0,81	4T-529X	29	NTN
		36,512				0,95	4T-59200	29	NTN
		36,512				0,98	4T-HM807046	29	NTN
		40,157				1,04	4T-4580	29	NTN
	41,275				1,42	4T-619	29	NTN	
	43,764				1,82	4T-5565	29	NTN	
	44,450				1,83	4T-65200	29	NTN	
51,592	88,900	22,225	16,513	20,638	0,51	4T-368S/362A	29	NTN	
	90,000	22,225	15,875	22,225	0,52	4T-368S/362	29	NTN	
		22,225			0,34	4T-368S	29	NTN	
52,388	85,000	20,000	15,000	20,000	0,41	4T-CR-1075	29	NTN	
	92,075	25,400	19,845	25,400	0,67	4T-28584/28521	29	NTN	
	93,264	30,302	23,812	30,162	0,82	4T-3767/3720	29	NTN	
	95,250	28,575	22,225	27,783	0,85	4T-33890/33821	29	NTN	
	95,250	28,575	22,225	28,575	0,58	4T-33891/33821	29	NTN	
	112,712	65,088			2,78	4T-55206/55444D+A	30	NTN	
		25,400			0,43	4T-28584	29	NTN	
		28,575			0,58	4T-33891	29	NTN	
		28,575			0,58	4T-33890	29	NTN	
		30,302			0,52	4T-3767	29	NTN	
53,975	88,900	19,050	13,492	19,050	0,44	4T-LM806649/LM806610	29	NTN	
	95,199	19,050	13,492	38,100	1,13	4T-CR-1193DF	29	NTN	
	95,250	28,575	22,225	28,575	0,81	4T-33895/33821	29	NTN	
	95,250	28,575	22,225	28,575	0,82	4T-33895/33822	29	NTN	
	96,838	21,946	15,857	21,000	0,63	4T-389A/382A	29	NTN	
	98,425	21,946	17,826	21,946	0,67	4T-389A/382	29	NTN	
	104,775	30,958	23,812	30,162	1,17	4T-45287/45220	29	NTN	
	104,775	36,512	28,575	36,512	1,41	4T-HM807049/HM807010	29	NTN	
	107,950	29,317	22,225	27,783	1,16	4T-456/453A	29	NTN	
	107,950	36,957	28,575	36,512	1,47	4T-539/532X	29	NTN	
	120,650	41,275	31,750	41,275	2,21	4T-621/612	29	NTN	



							 Brands
d	D	B	C	T	Kg	Reference	
53,975	122,238	31,750	23,812	33,338	1,79	4T-66584/66520	29 NTN
	122,238	43,764	36,512	43,658	2,64	4T-5578/5535	29 NTN
	123,825	32,791	25,400	36,512	2,00	4T-72212C/72487	29 NTN
	123,825	36,678	30,162	38,100	2,26	4T-557S/552A	29 NTN
	127,000	44,450	34,925	44,450	2,79	4T-65212/65500	29 NTN
	127,000	52,388	41,275	52,388	3,24	4T-6280/6220	29 NTN
	130,175	33,338	23,812	36,512	2,27	4T-HM911242/HM911210	29 NTN
	140,030	33,236	23,520	36,512	2,74	4T-78214/78551	29 NTN
	140,030	33,236	23,520	36,512	2,77	4T-78214C/78551	29 NTN
	140,030	33,236	23,520	36,512	2,74	4T-78215C/78551	29 NTN
		19,050			0,30	4T-LM806649	29 NTN
		21,946			0,45	4T-389A	29 NTN
		28,575			0,55	4T-3389S	29 NTN
		29,317			0,74	4T-456	29 NTN
		30,958			0,82	4T-45287	29 NTN
		31,750			1,24	4T-66584	29 NTN
		32,791			1,24	4T-72212C	29 NTN
		33,236			1,83	4T-78214	29 NTN
		33,236			1,84	4T-78215C	29 NTN
		33,338			1,35	4T-HM911242	29 NTN
		36,512			0,90	4T-HM807049	29 NTN
		36,678			1,50	4T-557S	29 NTN
		36,957			0,89	4T-539	29 NTN
	41,275			1,33	4T-621	29 NTN	
	43,764			1,81	4T-5578	29 NTN	
	52,388			2,03	4T-6280	29 NTN	
53,987	140,025	69,850			5,13	CR1-1163	30 NTN
54,488		36,512			0,89	4T-HM807048	29 NTN
54,500	104,775	36,512	28,575	36,512	1,38	4T-HM807048/HM807010	29 NTN
55,000	80,000	17,000	14,000	17,000	0,27	32911X	29 NTN
	90,000	23,000	17,500	23,000	0,59	32011 A	29 SNR
	90,000	23,000	17,500	23,000	0,56	32011X	29 NTN
	90,000	23,000	18,500	23,000	0,55	4T-JLM506849/JLM506810	29 NTN
	90,000	23,000	18,500	23,000	0,55	4T-JLM506849A/JLM506810	29 NTN
	90,000	23,000	20,500	25,000	0,58	4T-JLM506849A/JLM506811	29 NTN
	90,000	27,000	21,000	27,000	0,64	33011	29 NTN
	90,000	27,000	21,000	27,000	0,71	33011 A	29 SNR
	90,000	27,000	21,000	27,000	0,67	33011 VC12	29 SNR
	90,000	52,000			1,20	4T-CR1-1185	30 NTN
	95,000	29,000	23,500	29,000	0,82	4T-JM207049/JM207010	29 NTN
	95,000	30,000	23,000	30,000	0,85	33111	29 NTN
	95,000	30,000	23,000	30,000	0,83	33111 A	29 SNR
	96,838	21,946	15,875	21,000	0,62	4T-385/382A	29 NTN
	100,000	21,000	18,000	22,750	0,74	30211	29 NTN
	100,000	21,000	18,000	22,750	0,80	30211 A	29 SNR
	100,000	25,000	21,000	26,750	0,86	32211	29 NTN
	100,000	25,000	21,000	26,750	0,87	32211 A	29 SNR
	100,000	31,000	24,500	32,000	1,04	CR-1154	29 NTN
	100,000	35,000	27,000	35,000	1,15	33211	29 NTN
	100,000	35,000	27,000	35,000	1,21	33211 A	29 SNR
	100,000	42,250	35,000	42,250	1,35	4T-CR-1175	29 NTN
	100,000	51,000			1,55	4T-430211X	30 NTN
	100,000	51,000			1,56	430211XU	30 NTN
	100,000	60,000			1,85	432211U	30 NTN
	110,000	39,000	32,000	39,000	1,67	4T-JH307749/JH307710	29 NTN
	115,000	31,000	23,500	34,000	1,54	4T-T7FC055	29 NTN
	120,000	29,000	21,000	31,500	1,59	30311D	29 NTN
	120,000	29,000	21,000	31,500	1,58	31311 A	29 SNR







								Brands
d	D	B	C	T	Kg	Reference		
55,000	120,000	29,000	25,000	31,500	1,63	30311	29	NTN
	120,000	29,000	25,000	31,500	1,64	30311 A	29	SNR
	120,000	43,000	35,000	45,500	2,41	32311	29	NTN
	120,000	43,000	35,000	45,500	2,38	32311 A	29	SNR
	120,000	43,000	35,000	45,500	2,51	32311 BA	29	SNR
	120,000	43,000	35,000	45,500	2,46	32311C	29	NTN
	120,000	63,000			3,34	4T-30311DDF	30	NTN
	120,000	70,000			3,42	4T-430311DX	30	NTN
	120,000	70,000			3,54	430311XU	30	NTN
	120,000	97,000			5,05	432311U	30	NTN
		21,946			0,43	4T-385	29	NTN
		21,946			0,43	4T-385X	29	NTN
		23,000			0,36	4T-JLM506849	29	NTN
		23,000			0,36	4T-JLM506849A	29	NTN
		26,000			0,38	4T-JLM506848	29	NTN
		29,000			0,56	4T-JM207049	29	NTN
		29,000			0,55	4T-JM207049A	29	NTN
		39,000			1,11	4T-JH307749	29	NTN
55,562	97,630	24,608	19,446	24,608	0,77	4T-28680/28622	29	NTN
	123,825	32,791	25,400	36,512	1,99	4T-72218C/72487	29	NTN
	127,000	36,512	26,988	36,512	2,34	4T-HM813840/HM813810	29	NTN
		24,608			0,50	4T-28680	29	NTN
		32,791			1,20	4T-72218C	29	NTN
		36,512			1,70	4T-HM813840	29	NTN
55,575	96,838	21,946	15,875	21,000	0,61	4T-389/382A	29	NTN
		21,946			0,42	4T-389	29	NTN
57,150	96,838	21,946	15,875	21,000	0,58	4T-387/382A	29	NTN
	96,838	21,946	15,875	21,000	0,59	4T-387S/382A	29	NTN
	96,838	21,946	15,875	21,946	0,57	4T-387A/382A	29	NTN
	96,838	21,946	15,875	21,946	0,57	4T-387AS/382A	29	NTN
	96,838	21,946	20,274	25,400	0,66	4T-387A/382S	29	NTN
	97,630	24,608	19,446	24,608	0,74	4T-28682/28622	29	NTN
	97,630	36,512	28,575	24,608	1,42	4T-59200/59412	29	NTN
	98,425	21,946	17,826	21,946	0,62	4T-387/382	29	NTN
	98,425	21,946	17,826	21,946	0,62	4T-387A/382	29	NTN
	100,000	21,946	16,238	21,946	0,64	4T-CR-1194	29	NTN
	100,000	21,946	17,826	21,946	0,65	4T-387A/383A	29	NTN
	104,775	29,317	24,605	30,162	1,06	4T-462/453X	29	NTN
	104,775	29,317	24,605	30,162	1,05	4T-462A/453X	29	NTN
	104,775	29,317	24,605	30,162	1,06	4T-469/453X	29	NTN
	104,775	30,958	23,812	30,162	1,09	4T-45289/45220	29	NTN
	104,775	30,958	23,812	30,958	1,08	4T-45290/45220	29	NTN
	104,775	30,958	23,812	30,958	1,07	4T-45291/45220	29	NTN
	107,950	29,317	22,225	27,783	1,11	4T-469/453A	29	NTN
	107,950	29,317	22,225	29,317	1,11	4T-462/453A	29	NTN
	110,000	21,996	18,824	22,000	0,95	4T-390/394A	29	NTN
	110,000	29,317	27,000	27,795	1,24	4T-469/454	29	NTN
	112,712	30,048	23,812	30,162	1,38	4T-3979/3920	29	NTN
	112,712	30,162	23,812	30,162	1,41	4T-39580/39520	29	NTN
	112,712	30,162	23,812	30,162	1,40	4T-39581/39520	29	NTN
	117,475	30,162	23,812	30,162	1,58	4T-33225/33462	29	NTN
	117,475	31,750	23,812	33,338	1,54	4T-66225/66462	29	NTN
	120,650	41,275	31,750	41,275	2,12	4T-623/612	29	NTN
	123,825	32,791	25,400	36,512	1,96	4T-72225C/72487	29	NTN
	123,825	36,678	30,162	38,100	2,18	4T-555S/552A	29	NTN
	140,030	33,236	23,520	36,512	2,69	4T-78225/78551	29	NTN
		21,946			0,40	4T-387	29	NTN
		21,946			0,40	4T-387A	29	NTN
		21,946			0,40	4T-387S	29	NTN



							 Brands	
d	D	B	C	T	Kg	Reference		
57,150		21,996			0,69	4T-390	29	NTN
		24,608			0,47	4T-28682	29	NTN
		29,317			0,68	4T-462A	29	NTN
		29,317			0,68	4T-462	29	NTN
		29,317			0,68	4T-469	29	NTN
		30,048			0,94	4T-3979	29	NTN
		30,162			1,14	4T-33225	29	NTN
		30,162			1,04	4T-39580	29	NTN
		30,162			1,03	4T-39581	29	NTN
		30,958			0,75	4T-45289	29	NTN
		30,958			0,74	4T-45290	29	NTN
		30,958			0,73	4T-45291	29	NTN
		31,750			0,98	4T-66225	29	NTN
		32,791			1,16	4T-72225C	29	NTN
		33,236			1,75	4T-78225	29	NTN
		36,678			1,41	4T-555S	29	NTN
		41,275			1,24	4T-623	29	NTN
	41,275			1,98	4T-635	29	NTN	
57,163		21,946			0,39	4T-387AS	29	NTN
57,531	96,838	21,946	15,875	21,000	0,58	4T-388A/382A	29	NTN
	98,425	21,946	17,826	21,946	0,61	4T-388A/382	29	NTN
		21,946			0,39	4T-388A	29	NTN
58,738		30,048			0,91	4T-3981	29	NTN
59,972	122,238	31,750	23,812	33,338	1,66	4T-66589/66520	29	NTN
59,977		25,400			0,53	4T-28980	29	NTN
60,000	85,000	17,000	14,000	17,000	0,29	32912X	29	NTN
	95,000	23,000	17,500	23,000	0,63	32012 A	29	SNR
	95,000	23,000	17,500	23,000	0,58	32012X	29	NTN
	95,000	24,000	19,000	24,000	0,60	4T-JLM508748/JLM508710	29	NTN
	95,000	26,000	21,000	27,000	0,65	CR-1252L	29	NTN
	95,000	27,000	21,000	27,000	0,69	33012	29	NTN
	95,000	27,000	21,000	27,000	0,70	33012 A	29	SNR
	100,000	30,000	23,000	30,000	0,91	33112	29	NTN
	100,000	30,000	23,000	30,000	0,92	33112 A	29	SNR
	107,950	25,400	19,050	25,400	0,99	4T-29580/29520	29	NTN
	110,000	21,996	18,824	22,000	0,91	4T-397/394A	29	NTN
	110,000	22,000	19,000	23,750	0,92	30212	29	NTN
	110,000	22,000	19,000	23,750	0,92	30212 A	29	SNR
	110,000	28,000	24,000	29,750	1,16	32212	29	NTN
	110,000	28,000	24,000	29,750	1,26	32212 A	29	SNR
	110,000	38,000	29,000	38,000	1,51	33212	29	NTN
	110,000	38,000	29,000	38,000	1,57	33212 A	29	SNR
	110,000	53,000			1,99	4T-430212X	30	NTN
	110,000	53,000			1,98	430212XU	30	NTN
	110,000	59,500			2,42	32212UDF	30	NTN
	110,000	66,000			2,51	432212U	30	NTN
	115,000	39,000	33,000	40,000	1,86	4T-T2EE060	29	NTN
	125,000	33,500	26,000	37,000	1,99	4T-T7FC060	29	NTN
	125,000	70,000			3,53	4T-CR1-1264ZZ	30	NTN
	130,000	31,000	22,000	33,500	1,97	30312D	29	NTN
	130,000	31,000	22,000	33,500	2,00	31312 A	29	SNR
	130,000	31,000	22,000	33,500	1,89	31312 VB22	29	SNR
	130,000	31,000	26,000	33,500	2,04	30312	29	NTN
	130,000	31,000	26,000	33,500	2,06	30312 A	29	SNR
	130,000	46,000	37,000	48,500	2,98	32312	29	NTN
	130,000	46,000	37,000	48,500	2,96	32312 A	29	SNR



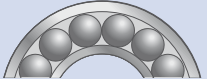



								Brands
d	D	B	C	T	Kg	Reference		
60,000	130,000	46,000	37,000	48,500	2,99	32312C	29	NTN
	130,000	67,000			4,09	4T-30312DDF	30	NTN
	130,000	74,000			4,22	4T-430312DX	30	NTN
	130,000	74,000			4,31	430312U	30	NTN
	130,000	104,000			6,29	432312U	30	NTN
	130,200	30,924	22,650	34,300	2,02	4T-HM911244/HM911210	29	NTN
	140,000	67,000			4,23	4T-CR1-1265	30	NTN
	146,050	39,688	25,400	41,275	3,22	4T-H913840/H913810	29	NTN
	175,000	69,000			7,58	CR1-1252	30	NTN
	495,300	170,612			181,00	E-CRT1215V	37	NTN
		21,996			0,65	4T-397	29	NTN
		24,000			0,40	4T-JLM508748	29	NTN
		25,400			0,71	4T-29580	29	NTN
		30,924			1,35	4T-HM911244	29	NTN
	39,688			2,32	4T-H913840	29	NTN	
60,013		25,400			0,72	4T-29582	29	NTN
60,325	100,000	25,400	19,845	25,400	0,77	4T-28985/28921	29	NTN
	101,600	25,400	19,845	25,400	0,80	4T-28985/28920	29	NTN
	101,600	28,400	19,845	28,400	0,87	4T-CR-1272	29	NTN
	112,712	30,048	23,812	30,162	1,30	4T-3980/3920	29	NTN
	122,238	38,354	29,718	38,100	2,02	4T-HM212044/HM212011	29	NTN
	122,238	43,764	36,512	43,658	2,44	4T-5583/5535	29	NTN
	123,825	36,678	30,162	38,100	2,10	4T-558/552A	29	NTN
	123,825	79,375			3,31	4T-NA558/552D	30	NTN
	127,000	36,512	26,988	36,512	2,21	4T-HM813841/HM813810	29	NTN
	127,000	44,450	34,925	44,450	2,65	4T-65237/65500	29	NTN
	130,175	33,338	23,812	36,512	2,12	4T-HM911245/HM911210	29	NTN
	136,525	33,236	23,520	36,512	2,44	4T-78238/78537	29	NTN
	140,000	36,513	33,000	38,500	2,70	CR-1257	29	NTN
		25,400			0,53	4T-28985	29	NTN
		30,048			0,87	4T-3980	29	NTN
		33,338			1,42	4T-HM911245	29	NTN
		36,512			1,57	4T-HM813841	29	NTN
	38,354			1,42	4T-HM212044	29	NTN	
	43,764			1,61	4T-5583	29	NTN	
	44,450			1,54	4T-65237	29	NTN	
60,337		33,236			1,67	4T-78238	29	NTN
61,000	150,000	35,000	30,000	38,000	3,38	4T-CR-1281	29	NTN
61,912	110,000	21,996	18,824	22,000	0,88	4T-392/394A	29	NTN
	112,712	21,996	23,812	26,967	1,06	4T-392/3920	29	NTN
	136,525	46,038	36,512	46,038	3,47	4T-H715334/H715311	29	NTN
	146,050	39,688	25,400	41,275	3,17	4T-H913842/H913810	29	NTN
		21,996			0,62	4T-392	29	NTN
		36,512			1,54	4T-HM813843	29	NTN
		39,688			2,27	4T-H913842	29	NTN
	46,038			2,49	4T-H715334	29	NTN	
61,976	99,979	24,608	19,050	24,608	0,71	4T-28990/28919	29	NTN
		24,608			0,49	4T-28990	29	NTN
62,738	100,000	25,400	19,845	25,400	0,71	4T-28995/28921	29	NTN
		25,400			0,49	4T-28995	29	NTN
63,500	94,458	19,050	15,083	19,050	0,45	4T-L610549/L610510	29	NTN
	104,775	22,000	15,875	22,000	0,67	4T-39250/39412	29	NTN
	107,950	25,400	19,050	25,400	0,91	4T-29585/29520	29	NTN
	107,950	25,400	19,050	25,400	0,92	4T-29586/29520	29	NTN



								Brands
d	D	B	C	T	Kg	Reference		
63,500	107,950	25,400	19,050	25,400	0,96	4T-29586/29522	29	NTN
	110,000	21,996	18,824	22,000	0,85	4T-390A/394A	29	NTN
	110,000	21,996	18,824	22,000	0,84	4T-395/394A	29	NTN
	110,000	21,996	22,000	22,000	0,79	4T-395/394	29	NTN
	110,000	25,400	19,050	25,400	0,98	4T-29585/29521	29	NTN
	110,000	30,048	23,812	30,162	1,13	4T-3982X/3927XS	29	NTN
	112,712	30,048	23,812	30,162	1,25	4T-3982/3920	29	NTN
	112,712	30,162	23,812	30,162	1,27	4T-39585/39520	29	NTN
	114,673	21,996	18,824	21,996	0,88	4T-390A/394AB	29	NTN
	120,000	29,007	24,237	29,794	1,49	4T-477/472	29	NTN
	120,000	29,007	24,237	29,794	1,48	4T-483/472	29	NTN
	122,238	38,354	29,718	38,100	1,95	4T-HM212046/HM212011	29	NTN
	122,238	38,354	29,718	38,354	1,92	4T-HM212047/HM212010	29	NTN
	122,238	38,354	29,718	38,354	1,92	4T-HM212047/HM212011	29	NTN
	122,238	43,764	36,512	43,764	2,31	4T-5584/5535	29	NTN
	123,825	36,678	30,162	38,100	2,01	4T-559/552A	29	NTN
	123,825	36,678	33,338	38,100	2,03	4T-559/552	29	NTN
	127,000	36,170	28,575	36,512	2,11	4T-565/563	29	NTN
	127,000	36,512	26,988	36,512	2,12	4T-HM813842/HM813810	29	NTN
	136,525	41,275	31,750	41,275	2,85	4T-639/632	29	NTN
	140,030	33,236	23,520	36,512	2,54	4T-78250/78551	29	NTN
		19,050			0,29	4T-L610549	29	NTN
		21,996			0,59	4T-390A	29	NTN
		21,996			0,59	4T-395	29	NTN
		22,000			0,49	4T-39250	29	NTN
		25,400			0,64	4T-29585	29	NTN
		25,400			0,65	4T-29586	29	NTN
		25,908			0,59	4T-M111048	29	NTN
		29,007			0,98	4T-483	29	NTN
		30,048			0,80	4T-3982	29	NTN
		30,162			0,90	4T-39585	29	NTN
		33,236			1,60	4T-78250	29	NTN
	36,170			1,44	4T-565	29	NTN	
	36,512			1,48	4T-HM813842	29	NTN	
	36,678			1,23	4T-559	29	NTN	
	38,354			1,35	4T-HM212046	29	NTN	
	38,354			1,34	4T-HM212047	29	NTN	
	41,275			1,79	4T-639	29	NTN	
65,000	90,000	17,000	14,000	17,000	0,31	32913X	29	NTN
	90,000	17,000	15,000	18,000	0,33	4T-CR-13A21	29	NTN
	100,000	23,000	17,500	23,000	0,67	32013 A	29	SNR
	100,000	23,000	17,500	23,000	0,63	32013X	29	NTN
	100,000	23,000	19,000	23,000	0,62	CR-1363	29	NTN
	100,000	27,000	21,000	27,000	0,73	33013	29	NTN
	100,000	27,000	21,000	27,000	0,78	33013 A	29	SNR
	105,000	23,000	18,500	24,000	0,74	4T-JLM710949/JLM710910	29	NTN
	105,000	23,000	18,500	24,000	0,74	4T-JLM710949C/JLM710910	29	NTN
	110,000	28,000	22,500	28,000	1,09	4T-JM511946/JM511910	29	NTN
	110,000	34,000	26,500	34,000	1,28	33113	29	NTN
	110,000	34,000	26,500	34,000	1,33	33113 A	29	SNR
	111,500	58,000			2,91	4T-C1R-1301	30	NTN
	120,000	23,000	20,000	24,750	1,18	30213	29	NTN
	120,000	23,000	20,000	24,750	1,15	30213 A	29	SNR
	120,000	23,000	20,000	24,750	1,15	30213 C	29	SNR
	120,000	31,000	27,000	32,750	1,55	32213	29	NTN
	120,000	31,000	27,000	32,750	1,55	32213 A	29	SNR
	120,000	38,500	32,000	39,000	1,84	4T-JH211749/JH211710	29	NTN
	120,000	41,000	32,000	41,000	1,98	33213	29	NTN
	120,000	41,000	32,000	41,000	2,03	33213 A	29	SNR
	120,000	56,000			2,49	4T-430213X	30	NTN
	120,000	56,000			2,54	430213XU	30	NTN



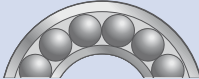



								Brands
d	D	B	C	T	Kg	Reference		
65,000	120,000	73,000			3,33	432213U	30	NTN
	130,000	33,500	26,000	37,000	2,11	4T-T7FC065	29	NTN
	140,000	33,000	23,000	36,000	2,42	30313D	29	NTN
	140,000	33,000	23,000	36,000	2,47	31313 A	29	SNR
	140,000	33,000	28,000	36,000	2,50	30313	29	NTN
	140,000	33,000	28,000	36,000	2,47	30313 A	29	SNR
	140,000	48,000	39,000	51,000	3,66	32313	29	NTN
	140,000	48,000	39,000	51,000	3,64	32313 A	29	SNR
	140,000	48,000	39,000	51,000	3,76	32313 BA	29	SNR
	140,000	72,000			4,13	4T-30313DDF	30	NTN
	140,000	77,500			2,73	CR1-1372LL	30	NTN
	140,000	79,000			5,16	4T-430313DX	30	NTN
	140,000	79,000			5,41	430313XU	30	NTN
	140,000	108,000			7,55	432313U	30	NTN
		23,000			0,50	4T-JLM710949C	29	NTN
		23,000			0,50	4T-JLM710949	29	NTN
		28,000			0,75	4T-JM511946	29	NTN
		30,000			0,76	4T-JM511945	29	NTN
	38,500			1,22	4T-JH211749	29	NTN	
65,088	135,755	56,007	44,450	53,975	3,71	4T-6379/6320	29	NTN
		56,007			2,33	4T-6379	29	NTN
66,000	124,000	41,500	34,000	41,500	2,14	4T-H212749/H212710	29	NTN
		41,500			1,48	4T-H212749	29	NTN
66,675	103,213	17,602	11,989	17,602	0,48	4T-L812148/L812111	29	NTN
	107,950	25,400	19,050	25,400	0,85	4T-29590/29520	29	NTN
	107,950	25,400	19,050	25,400	0,86	4T-29590/29522	29	NTN
	110,000	21,996	18,824	22,000	0,79	4T-395A/394A	29	NTN
	110,000	21,996	18,824	22,000	0,79	4T-395S/394A	29	NTN
	110,000	21,996	22,000	22,000	0,79	4T-395A/394	29	NTN
	110,000	25,400	19,050	25,400	0,91	4T-29590/29521	29	NTN
	112,712	30,048	23,812	30,162	1,17	4T-3984/3920	29	NTN
	112,712	30,048	23,812	30,162	1,19	4T-3984/3925	29	NTN
	112,712	30,048	23,812	30,162	1,18	4T-3994/3920	29	NTN
	112,712	30,162	23,812	30,162	1,19	4T-39590/39520	29	NTN
	113,487	23,447	18,824	22,000	0,91	4T-395CS/394CS	29	NTN
	117,475	30,162	23,812	30,162	1,33	4T-33262/33462	29	NTN
	122,238	38,354	29,718	38,354	1,86	4T-HM212049/HM212010	29	NTN
	123,825	36,678	30,162	38,100	1,92	4T-560/552A	29	NTN
	123,825	36,678	33,338	38,100	1,95	4T-560/552	29	NTN
	127,000	36,512	26,988	36,512	2,03	4T-HM813844/HM813810	29	NTN
	130,175	41,275	31,750	41,275	2,41	4T-641/633	29	NTN
	135,755	56,007	44,450	56,007	3,64	4T-6386/6320	29	NTN
	136,525	41,275	31,750	41,275	2,75	4T-H414242/H414210	29	NTN
	136,525	41,275	31,750	41,275	2,74	4T-641/632	29	NTN
	136,525	46,038	36,512	46,038	3,26	4T-H715341A/H715311	29	NTN
		17,602			0,34	4T-L812148	29	NTN
		21,996			0,53	4T-395A	29	NTN
		21,996			0,53	4T-395S	29	NTN
		25,400			0,58	4T-29590	29	NTN
		30,048			0,73	4T-3984	29	NTN
		30,048			0,72	4T-3994	29	NTN
		30,162			0,91	4T-33262	29	NTN
		30,162			0,83	4T-39590	29	NTN
		36,512			1,39	4T-HM813844	29	NTN
		36,678			1,15	4T-560	29	NTN
	38,354			1,26	4T-HM212049	29	NTN	
	41,275			1,89	4T-H414242	29	NTN	
	41,275			1,68	4T-641	29	NTN	
	46,038			2,32	4T-H715341A	29	NTN	



							 Brands
d	D	B	C	T	Kg	Reference	
66,675		56,007			2,26	4T-6386	29 NTN
68,262	110,000	21,996	18,824	22,000	0,76	4T-399A/394A	29 NTN
	110,000	21,996	18,824	22,000	0,75	4T-399AS/394A	29 NTN
	120,000	29,007	24,237	29,794	1,37	4T-480/472	29 NTN
	123,825	36,678	30,162	38,100	1,86	4T-560S/552A	29 NTN
	136,525	41,275	31,750	41,275	2,70	4T-H414245/H414210	29 NTN
	136,525	46,038	36,512	46,038	3,24	4T-H715343/H715311	29 NTN
	152,400	46,038	31,750	47,625	3,77	4T-9185/9121	29 NTN
	161,925	46,038	31,750	49,212	4,64	4T-9278/9220	29 NTN
		21,996			0,49	4T-399AS	29 NTN
		21,996			0,50	4T-399A	29 NTN
		29,007			0,88	4T-480	29 NTN
		36,678			1,10	4T-560S	29 NTN
		41,275			1,89	4T-H414245	29 NTN
		46,038			2,49	4T-9185	29 NTN
		46,038			2,28	4T-H715343	29 NTN
69,850	101,600	19,050	15,083	19,050	0,51	4T-L713049/L713010	29 NTN
	112,712	25,400	19,050	25,400	0,95	4T-29675/29620	29 NTN
	117,475	30,162	23,812	30,162	1,26	4T-33275/33462	29 NTN
	120,000	29,007	23,444	29,007	1,50	4T-482/472A	29 NTN
	120,000	29,007	24,237	29,794	1,33	4T-482/472	29 NTN
	120,000	30,162	23,444	30,162	1,35	4T-33275/33472	29 NTN
	120,000	32,545	26,195	32,545	1,47	4T-47487/47420	29 NTN
	120,000	65,090			2,73	NA482/472D	30 NTN
	120,000	65,090			2,85	4T-482/472D+A	30 NTN
	120,650	25,400	19,050	25,400	1,17	4T-29675/29630	29 NTN
	123,825	29,007	24,605	30,162	1,50	4T-482/472X	29 NTN
	127,000	36,170	28,575	36,512	1,92	4T-566/563	29 NTN
	127,000	36,512	26,988	36,512	1,90	4T-HM813846/HM813810	29 NTN
	136,525	41,275	31,750	41,275	2,63	4T-643/632	29 NTN
	136,525	95,250			5,76	4T-NA643/632D	30 NTN
	136,525	95,250			5,26	4T-643/632D+A	30 NTN
	146,050	39,688	25,400	41,275	2,88	4T-H913849/H913810	29 NTN
	146,050	41,275	31,750	41,275	2,50	4T-655/653	29 NTN
	150,089	46,672	36,512	46,672	3,92	4T-745A/742	29 NTN
	168,275	56,363	41,275	53,975	6,13	4T-835/832	29 NTN
		19,050			0,33	4T-L713049	29 NTN
		25,400			0,67	4T-29675	29 NTN
		29,007			0,80	4T-482	29 NTN
		30,162			0,83	4T-33275	29 NTN
		32,545			0,98	4T-47487	29 NTN
		36,170			1,24	4T-566	29 NTN
		39,688			1,98	4T-H913849	29 NTN
		41,275			1,57	4T-643	29 NTN
		41,275			2,50	4T-655	29 NTN
		46,672			2,86	4T-745A	29 NTN
		56,363			4,39	4T-835	29 NTN
69,952	121,442	23,012	17,462	24,608	1,11	4T-34274/34478	29 NTN
		23,012			0,78	4T-34274	29 NTN
69,987	176,212	53,183	36,512	54,770	6,40	4T-H916642/H916610	29 NTN
70,000	100,000	20,000	16,000	20,000	0,48	32914X	29 NTN
	110,000	25,000	19,000	25,000	0,90	32014 A	29 SNR
	110,000	25,000	19,000	25,000	0,85	32014X	29 NTN
	110,000	25,000	20,500	26,000	0,88	4T-JLM813049/JLM813010	29 NTN
	110,000	31,000	25,500	31,000	1,07	33014	29 NTN
	110,000	31,000	25,500	31,000	1,11	33014 A	29 SNR
	115,000	29,000	23,000	29,000	1,11	4T-JM612949/JM612910	29 NTN



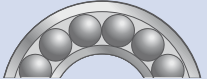



								Brands
d	D	B	C	T	Kg	Reference		
70,000	120,000	29,007	24,237	29,794	1,31	4T-484/472	29	NTN
	120,000	37,000	29,000	37,000	1,66	33114	29	NTN
	125,000	24,000	21,000	26,250	1,28	30214	29	NTN
	125,000	24,000	21,000	26,250	1,30	30214 A	29	SNR
	125,000	26,250			2,69	30214UDF	30	NTN
	125,000	31,000	27,000	33,250	1,68	32214	29	NTN
	125,000	31,000	27,000	33,250	1,74	32214 A	29	SNR
	125,000	41,000	32,000	41,000	2,08	33214	29	NTN
	125,000	41,000	32,000	41,000	2,17	33214 A	29	SNR
	125,000	59,000			2,67	4T-430214	30	NTN
	125,000	59,000			2,80	430214U	30	NTN
	125,000	74,000			3,56	432214U	30	NTN
	136,525	46,038	36,512	46,038	2,82	4T-H715347/H715311	29	NTN
	140,000	35,500	27,000	39,000	2,57	4T-T7FC070	29	NTN
	150,000	35,000	25,000	38,000	2,88	30314D	29	NTN
	150,000	35,000	25,000	38,000	2,95	31314 A	29	SNR
	150,000	35,000	30,000	38,000	3,02	30314	29	NTN
	150,000	35,000	30,000	38,000	3,05	30314 A	29	SNR
	150,000	51,000	42,000	54,000	4,46	32314	29	NTN
	150,000	51,000	42,000	54,000	4,31	32314 A	29	SNR
	150,000	51,000	42,000	54,000	4,42	32314 BA	29	SNR
	150,000	51,000	42,000	54,000	4,18	32314C	29	NTN
	150,000	76,000			6,20	4T-30314DDF	30	NTN
	150,000	76,000			6,14	30314UDF	30	NTN
	150,000	83,000			6,23	4T-430314DX	30	NTN
	150,000	83,000			6,42	430314DXU	30	NTN
	150,000	83,000			6,37	430314XU	30	NTN
	150,000	116,000			9,28	432314U	30	NTN
	204,000	76,200			16,00	CR1-1461	30	NTN
	240,000	90,000			13,19	E-CR1-1493LL	30	NTN
	249,000	100,000			24,40	CR1-1460	30	NTN
		25,000			0,58	4T-JLM813049	29	NTN
		29,000			0,75	4T-JM612949	29	NTN
	29,007			0,84	4T-484	29	NTN	
71,438	117,475	30,162	23,812	30,162	1,21	4T-33281/33462	29	NTN
	120,000	30,162	23,444	30,162	1,30	4T-33281/33472	29	NTN
	120,000	32,545	26,195	32,545	1,42	4T-47490/47420	29	NTN
	127,000	36,170	28,575	36,512	1,87	4T-567A/563	29	NTN
	127,000	36,512	26,988	36,512	1,84	4T-HM813849/HM813810	29	NTN
	136,525	41,275	31,750	41,275	2,58	4T-H414249/H414210	29	NTN
	136,525	41,275	31,750	41,275	2,57	4T-644/632	29	NTN
	136,525	41,275	31,750	41,275	2,52	4T-645/632	29	NTN
	136,525	46,038	36,512	46,038	3,11	4T-H715345/H715311	29	NTN
		30,162			0,78	4T-33281	29	NTN
		32,545			0,98	4T-47490	29	NTN
		36,512			1,24	4T-HM813849	29	NTN
		41,275			1,78	4T-H414249	29	NTN
		41,275			1,52	4T-644	29	NTN
		41,275			1,50	4T-645	29	NTN
		46,038			2,14	4T-H715345	29	NTN
73,025	112,712	25,400	19,050	25,400	0,86	4T-29685/29620	29	NTN
	114,287	58,738			2,09	4T-29685/29622D+A	30	NTN
	117,475	30,162	23,812	30,162	1,18	4T-33287/33462	29	NTN
	120,000	30,162	23,444	30,162	1,26	4T-33287/33472	29	NTN
	127,000	36,170	28,575	36,512	1,82	4T-567/563	29	NTN
	127,000	80,962			3,85	4T-NA567/563D	30	NTN
	139,992	36,098	28,575	36,512	2,53	4T-576/572	29	NTN
	149,225	54,229	44,450	54,229	4,42	4T-6460/6420	29	NTN
	150,089	46,672	36,512	44,450	3,79	4T-744/742	29	NTN
		25,400			0,60	4T-29685	29	NTN



							 Brands	
d	D	B	C	T	Kg	Reference		
73,025		30,162			0,74	4T-33287	29	NTN
		36,170			1,16	4T-567	29	NTN
		39,370			0,97	4T-M514546	29	NTN
		46,672			2,73	4T-744	29	NTN
		54,229			2,79	4T-6460	29	NTN
73,817	112,712	25,400	19,050	25,400	0,86	4T-29688/29620	29	NTN
	127,000	36,170	28,575	36,512	1,80	4T-568/563	29	NTN
		25,400			0,59	4T-29688	29	NTN
		36,170			1,13	4T-568	29	NTN
74,612	139,992	36,098	28,575	36,512	2,48	4T-577/572	29	NTN
75,000	105,000	20,000	16,000	20,000	0,51	32915X	29	NTN
	105,000	40,000			0,99	32915DF	30	NTN
	115,000	25,000	19,000	25,000	0,91	32015 A	29	SNR
	115,000	25,000	19,000	25,000	0,90	32015X	29	NTN
	115,000	25,000	19,000	25,000	0,88	4T-JLM714149/JLM714110	29	NTN
	115,000	31,000	25,500	31,000	1,11	33015	29	NTN
	115,000	31,000	25,500	31,000	1,18	33015 A	29	SNR
	115,000	31,000	25,500	31,000	1,15	33015 VC12	29	SNR
	115,000	62,000			2,27	33015UDF	30	NTN
	120,000	29,500	25,000	31,000	1,28	4T-JM714249/JM714210	29	NTN
	125,000	37,000	29,000	37,000	1,73	33115	29	NTN
	125,000	37,000	29,000	37,000	1,81	33115 A	29	SNR
	130,000	25,000	22,000	27,250	1,41	30215	29	NTN
	130,000	25,000	22,000	27,250	1,40	30215 A	29	SNR
	130,000	25,000	22,000	27,250	1,39	30215 C	29	SNR
	130,000	31,000	27,000	33,250	1,72	32215	29	NTN
	130,000	31,000	27,000	33,250	1,77	32215 A	29	SNR
	130,000	41,000	31,000	41,000	2,20	33215	29	NTN
	130,000	41,000	31,000	41,000	2,27	33215 A	29	SNR
	130,000	54,500			2,85	4T-30215DF	30	NTN
	130,000	62,000			2,99	4T-430215	30	NTN
	130,000	62,000			3,08	430215U	30	NTN
	130,000	66,500			3,55	32215UDF	30	NTN
	130,000	74,000			3,68	432215U	30	NTN
	130,000	80,000			4,00	CR1-1561	30	NTN
	145,000	51,000	42,000	51,000	3,77	4T-JH415647/JH415610	29	NTN
	160,000	37,000	26,000	40,000	3,54	30315D	29	NTN
	160,000	37,000	31,000	40,000	3,54	30315	29	NTN
	160,000	37,000	31,000	40,000	3,57	30315 A	29	SNR
	160,000	55,000	45,000	58,000	5,40	32315	29	NTN
	160,000	55,000	45,000	58,000	5,37	32315 A	29	SNR
	160,000	55,000	45,000	58,000	5,20	32315 BC	29	SNR
	160,000	55,000	45,000	58,000	5,65	32315C	29	NTN
	160,000	80,000			7,20	30315DUDF	30	NTN
	160,000	87,000			7,31	430315DU	30	NTN
	160,000	87,000			7,71	430315XU	30	NTN
	160,000	125,000			11,50	432315U	30	NTN
		25,000			0,60	4T-JLM714149	29	NTN
		29,500			0,84	4T-JM714249	29	NTN
		51,000			2,63	4T-JH415647	29	NTN
76,000	132,000	39,000	32,000	39,000	2,08	4T-HM215249/HM215210	29	NTN
		39,000			1,43	4T-HM215249	29	NTN
76,200	109,538	19,050	15,083	19,050	0,58	4T-L814749/L814710	29	NTN
	121,442	23,012	17,462	24,608	0,98	4T-34300/34478	29	NTN
	121,442	23,012	17,462	24,608	0,98	4T-34301/34478	29	NTN
	127,000	23,012	19,842	26,998	1,19	4T-34301/34500	29	NTN
	127,000	31,000	22,225	31,000	1,44	4T-42687/42620	29	NTN



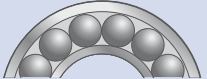



								Brands	
d	D	B	C	T	Kg	Reference			
76,200	127,000	31,000	22,225	31,000	1,42	4T-42688/42620	29	NTN	
	133,350	33,338	26,195	33,338	1,92	4T-47678/47620	29	NTN	
	133,350	33,338	26,195	33,338	1,90	4T-47679/47620	29	NTN	
	133,350	39,688	32,545	39,688	2,43	4T-HM516442/HM516410	29	NTN	
	135,733	46,100	34,925	44,450	2,75	4T-5760/5735	29	NTN	
	136,525	29,769	22,225	30,162	1,80	4T-495A/493	29	NTN	
	136,525	29,769	22,225	30,162	1,78	4T-495AX/493	29	NTN	
	136,525	69,850				4,15	4T-495A/493D+A	30	NTN
	139,700	36,098	28,575	36,098	2,40	4T-575/572X	29	NTN	
	139,992	36,098	28,575	36,512	2,43	4T-575/572	29	NTN	
	139,992	36,098	28,575	36,512	2,41	4T-575S/572	29	NTN	
	142,138	46,100	33,338	44,450	2,91	4T-HM515745/HM515716	29	NTN	
	146,050	41,275	31,750	41,275	3,04	4T-659/653	29	NTN	
	149,225	54,229	44,450	54,229	4,26	4T-6461/6420	29	NTN	
	149,225	54,229	44,450	54,229	4,24	4T-6461A/6420	29	NTN	
	150,089	46,672	36,512	46,672	3,64	4T-748S/742	29	NTN	
	161,925	33,338				3,58	CRT1512	37	NTN
	161,925	48,260	38,100	48,260	4,72	4T-755/752	29	NTN	
	161,925	55,100	42,862	55,100	5,43	4T-6575/6535	29	NTN	
	161,925	55,100	42,862	55,100	5,44	4T-6576/6535	29	NTN	
	161,925	105,562				9,08	4T-9285/9220D+A	30	NTN
	171,450	50,800	31,750	49,212	5,26	4T-9378/9321	29	NTN	
	171,450	125,412				13,60	4T-843/834D+A	30	NTN
	180,975	53,183	35,720	53,975	6,60	4T-H917840/H917810	29	NTN	
	190,500	57,531	46,038	57,150	8,69	4T-HH221430/HH221410	29	NTN	
		23,012				0,66	4T-34300	29	NTN
		23,012				0,65	4T-34301	29	NTN
		29,769				1,24	4T-495A	29	NTN
		29,769				1,24	4T-495AX	29	NTN
		31,000				1,01	4T-42687	29	NTN
		31,000				0,99	4T-42688	29	NTN
		33,338				1,32	4T-47678	29	NTN
		33,338				1,34	4T-47679	29	NTN
		33,338				1,37	4T-47680	29	NTN
		36,098				1,64	4T-575	29	NTN
		41,275				2,15	4T-659	29	NTN
	46,672				2,58	4T-748S	29	NTN	
	48,260				3,11	4T-755	29	NTN	
	54,229				2,63	4T-6461	29	NTN	
	54,229				2,60	4T-6461A	29	NTN	
	55,100				3,74	4T-6575	29	NTN	
	55,100				3,77	4T-6576	29	NTN	
	46,100				1,84	4T-HM515745	29	NTN	
77,788	117,475	25,400	19,050	25,400	0,93	4T-LM814849/LM814810	29	NTN	
	121,442	23,012	17,462	24,608	0,94	4T-34306/34478	29	NTN	
	127,000	23,012	19,842	26,988	1,15	4T-34306/34500	29	NTN	
	127,000	31,000	22,225	31,000	1,39	4T-42690/42620	29	NTN	
	136,525	29,769	22,225	30,162	1,78	4T-495AS/493	29	NTN	
	136,525	46,038	36,512	46,038	2,84	4T-H715348/H715311	29	NTN	
		16,400				0,38	4T-34492A	29	NTN
		23,012				0,62	4T-34306	29	NTN
		25,400				0,63	4T-LM814849	29	NTN
		31,000				0,96	4T-42690	29	NTN
		46,038				1,86	4T-H715348	29	NTN
	79,375	146,050	41,275	653,000	41,275	2,91	4T-661/653	29	NTN
152,400		41,275	31,750	41,275	3,28	4T-661/652	29	NTN	
161,925		48,260	38,100	47,625	4,55	4T-756A/752	29	NTN	
190,500		57,531	46,038	57,150	8,52	4T-HH221431/HH221410	29	NTN	
		41,275				2,02	4T-661	29	NTN
	48,260				2,94	4T-756A	29	NTN	



							 Brands
d	D	B	C	T	Kg	Reference	
79,985	139,992	82,550			4,79	4T-578/572D+A	30 NTN
	139,992	82,550			5,13	4T-578/572DC+A	30 NTN
80,000	110,000	20,000	16,000	20,000	0,54	32916X	29 NTN
	125,000	29,000	22,000	29,000	1,33	32016 A	29 SNR
	125,000	29,000	22,000	29,000	1,28	32016X	29 NTN
	125,000	36,000	29,500	36,000	1,60	33016	29 NTN
	125,000	36,000	29,500	36,000	1,68	33016 A	29 SNR
	125,000	36,000	29,500	36,000	1,61	33016 VC12	29 SNR
	130,000	34,000	28,500	35,000	1,72	4T-JM515649/JM515610	29 NTN
	130,000	37,000	29,000	37,000	1,84	33116	29 NTN
	130,000	37,000	29,000	37,000	1,91	33116 A	29 SNR
	140,000	26,000	22,000	28,250	1,68	30216	29 NTN
	140,000	26,000	22,000	28,250	1,74	30216 A	29 SNR
	140,000	33,000	28,000	35,250	2,16	32216	29 NTN
	140,000	33,000	28,000	35,250	2,20	32216 A	29 SNR
	140,000	46,000	35,000	46,000	2,92	33216	29 NTN
	140,000	46,000	35,000	46,000	2,95	33216 A	29 SNR
	140,000	61,000			3,54	CR1-1677C3	30 NTN
	140,000	64,000			3,70	430216XU	30 NTN
	140,000	78,000			4,53	432216XU	30 NTN
	147,000	40,000	35,200	40,000	2,94	4T-HM218238/HM218210	29 NTN
	170,000	39,000	27,000	42,500	4,11	30316D	29 NTN
	170,000	39,000	33,000	42,500	4,41	30316	29 NTN
	170,000	39,000	33,000	42,500	4,36	30316 A	29 SNR
	170,000	58,000	48,000	61,500	6,09	32316	29 NTN
	170,000	58,000	48,000	61,500	6,30	32316 BC12	29 SNR
	170,000	58,000	48,000	61,500	6,50	32316C	29 NTN
	170,000	85,000			8,46	30316DUDF	30 NTN
	170,000	92,000			8,99	430316DU	30 NTN
	170,000	92,000			9,10	430316XU	30 NTN
	170,000	131,000			13,60	432316U	30 NTN
		34,000			1,14	4T-JM515649	29 NTN
		46,672			2,42	4T-748	29 NTN
		49,212			5,72	4T-98316	29 NTN
80,962	133,350	33,338	26,195	33,338	1,78	4T-47681/47620	29 NTN
	136,525	29,769	22,225	30,162	1,66	4T-496/493	29 NTN
	136,525	69,850			3,89	4T-496/493DC+A	30 NTN
	139,992	36,098	28,575	36,512	2,26	4T-581/572	29 NTN
	150,089	46,672	36,512	46,672	3,50	4T-740/742	29 NTN
		29,769			1,12	4T-496	29 NTN
		33,338			1,20	4T-47681	29 NTN
		36,098			1,40	4T-581	29 NTN
		46,672			2,50	4T-740	29 NTN
	82,550	115,888	21,433	16,670	20,638	0,64	4T-L116149/L116110
125,412		25,400	19,845	25,400	1,07	4T-27687/27620	29 NTN
133,350		29,769	22,225	30,162	1,49	4T-495/492A	29 NTN
133,350		33,338	26,195	33,338	1,72	4T-47686/47620	29 NTN
133,350		33,338	26,195	33,338	1,68	4T-47687/47620	29 NTN
133,350		39,688	32,545	39,688	2,16	4T-HM516448/HM516410	29 NTN
133,350		39,688	32,545	39,688	2,15	4T-HM516449/HM516410	29 NTN
136,525		29,769	22,225	30,162	1,60	4T-495/493	29 NTN
136,525		69,850			3,74	4T-495/493D+A	30 NTN
139,700		36,098	28,575	36,512	2,18	4T-580/572X	29 NTN
139,992		36,098	28,575	36,512	2,20	4T-580/572	29 NTN
139,992		36,098	28,575	36,512	2,19	4T-582/572	29 NTN
139,992		82,550			4,56	4T-580/572D	30 NTN
139,992		82,550			4,64	4T-582/572D+A	30 NTN
146,050		41,275	31,750	41,275	2,78	4T-663/653	29 NTN
150,089		46,672	36,512	46,672	3,37	4T-749A/742	29 NTN



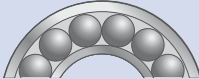



								Brands
d	D	B	C	T	Kg	Reference		
82,550	152,400	36,322	30,162	39,688	3,02	4T-595/592A	29	NTN
	152,400	41,275	31,750	41,275	3,15	4T-663/652	29	NTN
	155,575	101,600			7,30	4T-749A/742D	30	NTN
	155,575	101,600			7,50	4T-749A/742D+A	30	NTN
	161,925	48,260	38,100	47,625	4,42	4T-757/752	29	NTN
	161,925	55,100	42,862	53,975	5,09	4T-6559C/6535	29	NTN
	161,925	55,100	42,862	55,100	5,06	4T-6559/6535	29	NTN
	168,275	48,260	38,100	48,260	4,91	4T-757/753	29	NTN
	168,275	56,363	41,275	53,975	5,46	4T-842/832	29	NTN
	171,450	125,412			12,50	4T-842/834D+A	30	NTN
		25,400			0,70	4T-27687	29	NTN
		29,769			1,07	4T-495	29	NTN
		33,338			1,12	4T-47687	29	NTN
		33,338			1,14	4T-47686	29	NTN
		36,098			1,41	4T-580	29	NTN
		36,098			1,39	4T-582	29	NTN
		36,322			1,96	4T-595	29	NTN
		39,688			1,39	4T-HM516449	29	NTN
		39,688			1,39	4T-HM516448	29	NTN
		41,275			2,00	4T-663	29	NTN
	46,672			2,30	4T-749A	29	NTN	
	48,260			2,81	4T-757	29	NTN	
	56,363			3,72	4T-842	29	NTN	
83,345	125,412	25,400	19,845	25,400	1,06	4T-27689/27620	29	NTN
	125,412	25,400	19,845	25,400	1,05	4T-27690/27620	29	NTN
	125,412	25,400	19,845	25,400	1,04	4T-27691/27620	29	NTN
		25,400			0,68	4T-27690	29	NTN
84,138	133,350	29,769	22,225	30,162	1,45	4T-498/492A	29	NTN
	136,525	29,769	22,225	30,162	1,60	4T-498/493	29	NTN
	171,450	46,038	31,750	49,212	4,67	4T-9386H/9321	29	NTN
		29,769			1,02	4T-498	29	NTN
		41,275			1,82	4T-664	29	NTN
84,975	125,412	25,400	19,845	25,400	0,97	4T-27695/27620	29	NTN
		25,400			0,63	4T-27695	29	NTN
		29,769			0,99	4T-499A	29	NTN
85,000	120,000	23,000	18,000	23,000	0,77	32917X	29	NTN
	130,000	29,000	22,000	29,000	1,38	32017 A	29	SNR
	130,000	29,000	22,000	29,000	1,33	32017X	29	NTN
	130,000	29,000	24,000	30,000	1,35	4T-JM716648/JM716610	29	NTN
	130,000	29,000	24,000	30,000	1,37	4T-JM716649/JM716610	29	NTN
	130,000	36,000	29,500	36,000	1,70	33017	29	NTN
	130,000	36,000	29,500	36,000	1,73	33017 A	29	SNR
	130,000	36,000	29,500	36,000	1,73	33017 VC12	29	SNR
	140,000	38,000	31,500	39,000	2,28	4T-JHM516849/JHM516810	29	NTN
	140,000	41,000	32,000	41,000	2,40	33117	29	NTN
	140,000	41,000	32,000	41,000	2,49	33117 A	29	SNR
	150,000	28,000	24,000	30,500	2,10	30217	29	NTN
	150,000	28,000	24,000	30,500	2,14	30217 A	29	SNR
	150,000	36,000	30,000	38,500	2,70	32217	29	NTN
	150,000	36,000	30,000	38,500	2,68	32217 A	29	SNR
	150,000	46,000	38,000	46,000	3,36	4T-JH217249/JH217210	29	NTN
	150,000	49,000	37,000	49,000	3,58	33217	29	NTN
	150,000	49,000	37,000	49,000	3,68	33217 A	29	SNR
	150,000	61,000			4,46	30217UDF	30	NTN
	150,000	70,000			4,59	430217XU	30	NTN
150,000	77,000			5,64	4T-32217DF	30	NTN	
150,000	77,000			5,68	32217UDF	30	NTN	
150,000	86,000			5,85	432217XU	30	NTN	



							 Brands
d	D	B	C	T	Kg	Reference	
85,000	170,000	45,000	33,000	48,000	4,73	4T-T7FC085	29 NTN
	180,000	41,000	28,000	44,500	4,85	30317D	29 NTN
	180,000	41,000	34,000	44,500	5,20	30317	29 NTN
	180,000	60,000	46,000	63,500	7,13	32317 BC12	29 SNR
	180,000	60,000	49,000	63,500	7,15	32317	29 NTN
	180,000	60,000	49,000	63,500	7,45	32317 A	29 SNR
	180,000	89,000			10,20	30317DUDF	30 NTN
	180,000	98,000			10,60	430317DU	30 NTN
	180,000	98,000			12,44	430317XU	30 NTN
	180,000	137,000			15,40	432317U	30 NTN
		29,000			0,89	4T-JM716648	29 NTN
		29,000			0,92	4T-JM716649	29 NTN
		38,000			1,52	4T-JHM516849	29 NTN
		46,000			2,28	4T-JH217249	29 NTN
85,026	150,089	46,672	36,512	46,672	3,23	4T-749/742	29 NTN
		46,672			2,16	4T-749	29 NTN
85,725	133,350	29,769	22,225	30,162	1,43	4T-497/492A	29 NTN
	136,525	29,769	22,225	30,162	1,50	4T-497/493	29 NTN
	142,138	42,862	34,133	42,862	2,69	4T-HM617049/HM617010	29 NTN
	146,050	41,275	31,750	41,275	2,65	4T-665/653	29 NTN
	152,400	36,322	30,162	39,688	2,90	4T-596/592A	29 NTN
	152,400	41,275	31,750	41,275	3,02	4T-665/652	29 NTN
	161,925	48,260	38,100	48,260	4,26	4T-758/752	29 NTN
	168,275	56,363	41,275	53,975	5,28	4T-841/832	29 NTN
	184,150	73,025			8,53	NA497SW/K326071	30 NTN
		29,769			0,97	4T-497	29 NTN
		29,769			0,95	4T-497A	29 NTN
		36,322			1,84	4T-596	29 NTN
		41,275			2,93	4T-677	29 NTN
		41,275			1,74	4T-665	29 NTN
		41,275			1,72	4T-665A	29 NTN
	42,862			1,77	4T-HM617049	29 NTN	
	48,260			2,65	4T-758	29 NTN	
	56,363			3,54	4T-841	29 NTN	
87,312	152,400	82,550			5,41	4T-596S/592DC+A	30 NTN
87,960	148,430	28,971	21,433	28,575	1,99	4T-42346/42584	29 NTN
		28,971			1,44	4T-42346	29 NTN
88,900	121,442	15,083	11,112	15,083	0,45	4T-LL217849/LL217810	29 NTN
	123,825	20,638	16,670	20,638	0,73	4T-L217849/L217810	29 NTN
	148,430	28,971	21,433	28,971	1,96	4T-42350/42584	29 NTN
	149,225	66,672			4,50	4T-42350/42587D+A	30 NTN
	152,400	36,322	30,162	39,688	2,77	4T-593/592A	29 NTN
	152,400	39,688	30,162	39,688	2,86	4T-HM518445/HM518410	29 NTN
	152,400	82,550			5,56	NA593/592D	30 NTN
	152,400	82,550			5,76	4T-593/592D+A	30 NTN
	161,925	48,260	38,100	48,260	4,09	4T-759/752	29 NTN
	161,925	55,100	42,862	53,975	4,73	4T-6580/6535	29 NTN
	161,925	104,775			7,48	4T-NA759/752D	30 NTN
	161,925	104,775			7,48	4T-NA759SW/752D	30 NTN
	168,275	56,363	41,275	53,975	5,08	4T-850/832	29 NTN
	190,500	57,531	44,450	57,150	7,93	4T-855/854	29 NTN
	190,500	57,531	46,038	57,531	7,94	4T-HH221434/HH221410	29 NTN
	200,000	49,212	34,925	52,761	7,64	4T-98350/98788	29 NTN
	200,000	105,522			14,90	4T-98350/98788DF	30 NTN
	206,375	104,775			12,14	4T-NA759SW/K312486	30 NTN
		20,638			0,50	4T-L217849	29 NTN
		28,971			1,41	4T-42350	29 NTN



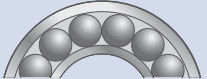



								Brands
d	D	B	C	T	Kg	Reference		
88,900		36,322			1,70	4T-593A	29	NTN
		36,322			0,76	4T-593	29	NTN
		39,688			2,10	4T-HM518445	29	NTN
		48,260			2,48	4T-759	29	NTN
		49,212			5,08	4T-98350	29	NTN
		55,100			3,06	4T-6580	29	NTN
		56,363			3,34	4T-850	29	NTN
		57,531			5,85	4T-HH221434	29	NTN
		57,531			5,18	4T-855	29	NTN
89,891	171,450	125,412			15,28	4T-850A/834D+A	30	NTN
90,000	125,000	23,000	18,000	23,000	0,80	32918X	29	NTN
	140,000	32,000	24,000	32,000	1,69	32018 A	29	SNR
	140,000	32,000	24,000	32,000	1,79	32018X	29	NTN
	140,000	39,000	32,500	39,000	2,19	33018	29	NTN
	140,000	39,000	32,500	39,000	2,20	33018 A	29	SNR
	140,000	72,500			3,67	CR1-1871	30	NTN
	145,000	34,000	27,000	35,000	2,11	4T-JM718149/JM718110	29	NTN
	147,000	40,000	32,500	40,000	2,52	4T-HM218248/HM218210	29	NTN
	150,000	45,000	35,000	45,000	3,20	33118	29	NTN
	150,000	45,000	35,000	45,000	3,15	33118 A	29	SNR
	155,000	44,000	35,500	44,000	3,33	4T-JHM318448/JHM318410	29	NTN
	155,000	85,000			6,10	4T-CR1-1881	30	NTN
	160,000	30,000	26,000	32,500	2,64	30218	29	NTN
	160,000	30,000	26,000	32,500	2,63	30218 A	29	SNR
	160,000	40,000	34,000	42,500	3,49	32218	29	NTN
	160,000	40,000	34,000	42,500	3,51	32218 A	29	SNR
	160,000	40,000	34,000	42,500	3,29	32218 C	29	SNR
	160,000	55,000	42,000	55,000	4,62	33218	29	NTN
	160,000	55,100	44,450	55,100	4,52	4T-6581X/6525X	29	NTN
	160,000	65,000			5,47	4T-30218DF	30	NTN
	160,000	74,000			5,76	430218U	30	NTN
	160,000	85,000			7,20	32218UDF	30	NTN
	160,000	94,000			7,35	432218U	30	NTN
	161,925	55,100	42,862	55,100	4,66	4T-6581X/6535	29	NTN
	190,000	43,000	30,000	46,500	5,66	30318D	29	NTN
	190,000	43,000	36,000	46,500	6,03	30318	29	NTN
	190,000	64,000	53,000	67,500	8,60	32318	29	NTN
	190,000	64,000	53,000	67,500	8,88	32318 A	29	SNR
	190,000	102,000			12,50	430318DU	30	NTN
	190,000	102,000			12,34	430318U	30	NTN
	190,000	144,000			18,20	432318U	30	NTN
	300,000	119,000			40,70	CR1-1812ZZC3	30	NTN
		34,000			1,46	4T-JM718149	29	NTN
	40,000			1,74	4T-HM218248	29	NTN	
	44,000			2,31	4T-JHM318448	29	NTN	
	55,100			1,58	4T-6581X	29	NTN	
90,488	161,925	48,260	38,100	47,625	4,01	4T-760/752	29	NTN
		48,260			2,40	4T-760	29	NTN
91,976	101,600	24,608	19,845	25,400	0,77	4T-28990/28920	29	NTN
92,075	146,050	34,925	26,195	34,925	2,06	4T-47890/47820	29	NTN
	149,225	66,672			4,23	4T-42362/42587D+A	30	NTN
	150,000	36,322	27,000	35,992	2,32	4T-598A/593X	29	NTN
	152,400	36,322	30,162	39,688	2,65	4T-598/592A	29	NTN
	152,400	36,322	30,162	39,688	2,63	4T-598A/592A	29	NTN
	168,275	41,275	30,162	41,275	3,87	4T-681/672	29	NTN
	168,275	41,275	30,162	41,275	3,87	4T-681A/672	29	NTN
	28,971			1,30	4T-42362	29	NTN	



							 Brands
d	D	B	C	T	Kg	Reference	
92,075		34,925			1,40	4T-47890	29 NTN
		36,322			1,59	4T-598	29 NTN
		36,322			1,54	4T-598A	29 NTN
		41,275			2,62	4T-681A	29 NTN
		41,275			2,62	4T-681	29 NTN
		48,006			3,72	4T-778	29 NTN
92,738	101,600	25,400	19,845	25,400	0,76	4T-28995/28920	29 NTN
93,662	148,430	28,971	21,433	28,575	1,80	4T-42368/42584	29 NTN
		28,971			1,25	4T-42368	29 NTN
95,000	130,000	23,000	18,000	23,000	0,85	32919X	29 NTN
	135,000	20,000	14,000	20,000	0,84	4T-JL819349/JL819310	29 NTN
	145,000	32,000	24,000	32,000	1,91	32019 A	29 SNR
	145,000	32,000	24,000	32,000	1,84	32019X	29 NTN
	145,000	39,000	32,500	39,000	2,34	33019 A	29 SNR
	145,000	45,000	38,000	39,000	2,27	33019	29 NTN
	150,000	34,000	27,000	35,000	2,17	4T-JM719149/JM719113	29 NTN
	170,000	32,000	27,000	34,500	3,07	30219	29 NTN
	170,000	32,000	27,000	34,500	3,15	30219 A	29 SNR
	170,000	43,000	37,000	45,500	4,22	32219	29 NTN
	170,000	43,000	37,000	45,500	4,30	32219 A	29 SNR
	170,000	69,000			6,45	30219UDF	30 NTN
	170,000	78,000			8,01	430219XU	30 NTN
	170,000	91,000			8,85	32219UDF	30 NTN
	170,000	100,000			9,04	432219XU	30 NTN
	180,000	45,000	33,000	49,000	5,21	4T-T7FC095	29 NTN
	180,000	100,000			12,00	CR1-1959LL	30 NTN
	200,000	45,000	32,000	49,500	6,47	30319D	29 NTN
	200,000	45,000	38,000	49,500	6,62	30319	29 NTN
	200,000	67,000	55,000	71,500	10,10	32319	29 NTN
	200,000	99,000			14,12	30319UDF	30 NTN
	200,000	108,000			15,00	430319XU	30 NTN
	200,000	151,000			21,50	432319U	30 NTN
	20,000			0,58	4T-JL819349	29 NTN	
	34,000			1,41	4T-JM719149	29 NTN	
95,250	128,588	15,083	11,908	15,875	0,52	4T-LL319349/LL319310	29 NTN
	130,175	21,433	16,670	21,433	0,78	4T-L319249/L319210	29 NTN
	146,050	34,925	26,195	34,925	1,94	4T-47896/47820	29 NTN
	147,638	36,322	26,192	35,717	2,09	4T-594A/592XE	29 NTN
	148,430	28,971	21,433	28,575	1,75	4T-42375/42584	29 NTN
	150,000	36,322	27,000	36,322	2,20	4T-594/593X	29 NTN
	152,400	36,322	30,162	39,688	2,51	4T-594/592A	29 NTN
	152,400	36,322	30,162	39,688	2,50	4T-594A/592A	29 NTN
	152,400	36,322	33,338	39,688	2,56	4T-594/592	29 NTN
	152,400	82,550			5,68	4T-594/592D+A	30 NTN
	157,162	36,116	26,195	36,512	2,76	4T-52375/52618	29 NTN
	161,925	82,547			6,60	4T-NA52375/52637D	30 NTN
	168,275	41,275	30,162	41,275	3,70	4T-683/672	29 NTN
	168,275	95,250			8,06	688TD/672+A	31 NTN
	171,450	48,260	38,100	47,625	4,58	4T-77375/77675	29 NTN
	190,500	57,531	46,038	57,150	7,50	4T-HH221440/HH221410	29 NTN
	200,025	73,025	58,738	73,025	10,80	4T-EH220749/EH220710	29 NTN
		21,433			0,53	4T-L319249	29 NTN
		28,971			1,20	4T-42375	29 NTN
		28,971			1,19	4T-42376	29 NTN
		34,925			1,28	4T-47896	29 NTN
		36,116			2,70	4T-52375	29 NTN
		36,322			1,44	4T-594	29 NTN
	36,322			1,44	4T-594A	29 NTN	



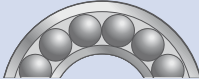



								Brands
d	D	B	C	T	Kg	Reference		
95,250		41,275			1,40	4T-683	29	NTN
		57,531			4,75	4T-864	29	NTN
96,838	148,430	28,971	21,433	28,971	1,69	4T-42381/42584	29	NTN
	149,225	28,971	24,608	31,750	1,85	4T-42381/42587	29	NTN
	188,912	46,038	31,750	50,800	5,67	4T-90381/90744	29	NTN
		28,971			1,12	4T-42381	29	NTN
		46,038			3,90	4T-90381	29	NTN
98,425	157,162	36,116	26,195	36,512	2,62	4T-52387/52618	29	NTN
	168,275	41,275	30,162	41,275	3,56	4T-685/672	29	NTN
	184,150	63,500	52,388	63,500	7,53	4T-HH421246/HH421210	29	NTN
		36,116			1,92	4T-52387	29	NTN
		41,275			2,80	4T-685	29	NTN
		48,006			3,66	4T-779	29	NTN
		63,500			4,98	4T-HH421246	29	NTN
99,975	212,725	66,675	53,975	66,675	11,50	4T-HH224334/HH224310	29	NTN
99,979	196,850	103,378			12,00	4T-HM821547/HM821511D+A	30	NTN
100,000	140,000	25,000	20,000	25,000	1,14	32920X	29	NTN
	145,000	22,500	17,500	24,000	1,11	4T-T4CB100	29	NTN
	150,000	32,000	24,000	32,000	1,95	32020 A	29	SNR
	150,000	32,000	24,000	32,000	1,91	32020X	29	NTN
	150,000	39,000	32,500	39,000	2,14	33020	29	NTN
	150,000	39,000	32,500	39,000	2,42	33020 A	29	SNR
	150,000	39,000	32,500	39,000	2,39	33020 VC12	29	SNR
	150,000	60,000			2,72	4T-CR-2064DB	30	NTN
	155,000	35,000	28,000	36,000	2,40	4T-JM720249/JM720210	29	NTN
	157,000	42,000	34,000	42,000	2,82	4T-HM220149/HM220110	29	NTN
	160,000	40,000	32,000	41,000	3,04	4T-JHM720249/JHM720210	29	NTN
	165,000	52,000			3,94	CRI-2052	30	NTN
	170,000	43,000	37,000	45,500	4,20	CR-2051	29	NTN
	170,000	155,000			14,50	CRO-2008	32	NTN
	180,000	34,000	29,000	37,000	3,78	30220	29	NTN
	180,000	34,000	29,000	37,000	3,79	30220 A	29	SNR
	180,000	46,000	39,000	49,000	5,20	32220	29	NTN
	180,000	46,000	39,000	49,000	5,14	32220 A	29	SNR
	180,000	63,000	48,000	63,000	6,82	33220	29	NTN
	180,000	74,000			7,80	4T-30220DFC3	30	NTN
	180,000	74,000			7,56	30220UDF	30	NTN
	180,000	82,000			8,08	CRI-2059	30	NTN
	180,000	83,000			8,11	430220XU	30	NTN
	180,000	98,000			9,76	32220UDF	30	NTN
	180,000	107,000			10,50	432220XU	30	NTN
	180,000	140,000			13,80	CRI-2010	30	NTN
	190,000	124,500			14,30	4T-CR1-2072	30	NTN
	190,000	124,500			14,30	CRI-2072	30	NTN
	215,000	47,000	39,000	51,500	8,56	30320	29	NTN
	215,000	47,000	39,000	51,500	7,72	30320	29	NTN
	215,000	51,000	35,000	56,500	8,67	31320X	29	NTN
	215,000	73,000	55,000	77,500	12,20	32320 B	29	SNR
	215,000	73,000	60,000	77,500	12,80	32320	29	NTN
	215,000	105,000			19,70	CRD-2005	31	NTN
	215,000	112,000			18,40	430320XU	30	NTN
	215,000	115,000			18,20	CRI-2054	30	NTN
	215,000	162,000			26,70	CR1-2088	30	NTN
215,000	162,000			26,50	432320U	30	NTN	
250,000	116,000			26,80	CRD-2051	31	NTN	
250,000	120,000			31,20	CRD-2011	31	NTN	
	35,000			1,63	4T-JM720249	29	NTN	



							 Brands
d	D	B	C	T	Kg	Reference	
100,000		40,000			2,07	4T-JHM720249	29 NTN
		42,000			1,98	4T-HM220149	29 NTN
100,012	157,162	36,116	26,195	36,512	2,55	4T-52393/52618	29 NTN
	161,925	82,547			6,25	4T-52393/52637D+A	30 NTN
		36,116			1,85	4T-52393	29 NTN
101,600	134,938	15,083	11,908	15,875	0,55	4T-LL420549/LL420510	29 NTN
	136,525	21,433	16,670	21,433	0,82	4T-L420449/L420410	29 NTN
	157,162	36,116	26,195	36,512	2,48	4T-52400/52618	29 NTN
	157,162	36,116	26,195	36,512	2,45	4T-52401/52618	29 NTN
	157,162	80,167			5,56	4T-52400D/52618+A	31 NTN
	168,275	41,275	30,162	41,275	3,40	4T-687/672	29 NTN
	168,275	41,275	69,850	92,075	7,29	4T-687/672D+A	29 NTN
	168,275	92,075			7,29	NA691/672D	30 NTN
	180,975	48,006	38,100	48,006	5,11	4T-780/772	29 NTN
	190,500	57,150			6,53	4T-NA861/854D	30 NTN
	190,500	57,531	44,450	57,531	7,00	4T-861/854	29 NTN
	190,500	57,531	46,038	57,150	7,06	4T-HH221449A/HH221410	29 NTN
	190,500	57,531	46,038	57,531	7,00	4T-HH221449/HH221410	29 NTN
	200,000	49,212	34,925	52,761	6,91	4T-98400/98788	29 NTN
	200,025	57,531	50,800	61,912	8,56	4T-HH221449/HH221416	29 NTN
	200,025	115,888			15,10	4T-98400/98789D+A	30 NTN
	212,725	66,675	53,975	66,675	11,32	4T-HH224335/HH224310	29 NTN
	212,725	66,675	53,975	66,675	11,20	4T-941/932	29 NTN
	212,725	142,875			23,70	4T-HH224335/HH224310D+A	30 NTN
	250,825	73,025	50,800	76,200	17,12	4T-HH923649/HH923610	29 NTN
		36,116			1,78	4T-52400	29 NTN
		36,116			1,75	4T-52401	29 NTN
		41,275			2,70	4T-687	29 NTN
		48,006			3,17	4T-780	29 NTN
		49,212			4,53	4T-98400	29 NTN
		57,531			4,90	4T-HH221449	29 NTN
		57,531			4,31	4T-861	29 NTN
		66,675			8,26	4T-HH224335	29 NTN
	66,675			7,10	4T-941	29 NTN	
104,775	180,975	48,006	38,100	48,006	4,92	4T-782/772	29 NTN
	180,975	48,006	38,100	48,006	4,90	4T-786/772	29 NTN
		48,006			2,96	4T-786	29 NTN
		48,006			2,98	4T-782	29 NTN
105,000	145,000	25,000	20,000	25,000	1,19	32921X	29 NTN
	160,000	35,000	26,000	35,000	2,42	32021 A	29 SNR
	160,000	35,000	26,000	35,000	2,42	32021X	29 NTN
	160,000	43,000	34,000	43,000	3,00	33021	29 NTN
	160,000	43,000	34,000	43,000	3,14	33021 A	29 SNR
	160,000	43,000	34,000	43,000	3,16	33021 VC12	29 SNR
	170,000	90,000			7,92	CRD-2151	31 NTN
	190,000	36,000	30,000	39,000	4,39	30221	29 NTN
	190,000	36,000	30,000	39,000	4,46	30221 A	29 SNR
	190,000	50,000	43,000	53,000	6,20	32221	29 NTN
	190,000	50,000	43,000	53,000	6,27	32221 A	29 SNR
	190,000	68,000	52,000	68,000	8,35	33221	29 NTN
	190,000	78,000			9,24	30221UDF	30 NTN
	190,000	88,000			9,73	430221XU	30 NTN
	190,000	115,000			13,10	432221XU	30 NTN
	190,000	117,000			12,90	CRI-2152	30 NTN
	190,000	210,000			26,00	CRO-2151	32 NTN
	225,000	49,000	41,000	53,500	9,79	30321	29 NTN
	225,000	53,000	36,000	58,000	9,68	31321X	29 NTN
	225,000	77,000	63,000	81,500	14,50	32321	29 NTN



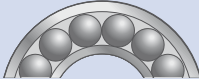



								Brands
d	D	B	C	T	Kg	Reference		
105,000	225,000	116,000			21,00	430321XU	30	NTN
	225,000	170,000			30,20	432321	30	NTN
	240,000	110,000			23,60	CRI-2105	30	NTN
106,362	165,100	36,512	26,988	36,512	2,76	4T-56418/56650	29	NTN
		36,512			1,89	4T-56418	29	NTN
107,950	158,750	21,438	15,875	23,020	1,37	4T-37425/37625	29	NTN
	159,987	34,925	26,988	34,925	2,37	4T-LM522546/LM522510	29	NTN
	161,925	34,925	26,988	34,925	2,37	4T-48190/48120	29	NTN
	165,100	36,512	26,988	36,512	2,69	4T-56425/56650	29	NTN
	165,100	36,512	26,988	36,512	2,60	4T-56426/56650	29	NTN
	165,100	82,550			5,90	4T-56425/56650D+A	30	NTN
	168,275	36,152	26,988	36,512	2,80	4T-56425/56662	29	NTN
	212,725	66,675	53,975	66,675	10,70	4T-936/932	29	NTN
		21,438			0,88	4T-37425	29	NTN
		34,925			1,59	4T-48190	29	NTN
		36,512			1,82	4T-56425	29	NTN
		36,512			1,84	4T-56426	29	NTN
		66,675			6,54	4T-936	29	NTN
	107,975	165,125	89,154			6,61	4T-NA56425SW/56650D	30
109,538	158,750	21,438	15,875	23,020	1,31	4T-37431/37625	29	NTN
	158,750	21,438	15,875	23,020	1,30	4T-37431A/37625	29	NTN
		21,438			0,84	4T-37431	29	NTN
		21,438			1,25	4T-37431A	29	NTN
109,987	159,987	34,925	26,988	34,925	2,24	4T-LM522548/LM522510	29	NTN
	159,987	34,925	26,988	34,925	2,27	4T-LM522549/LM522510	29	NTN
		34,925			1,49	4T-LM522549	29	NTN
		34,925			1,46	4T-LM522548	29	NTN
109,992	177,800	41,275	30,162	41,275	3,77	4T-64433/64700	29	NTN
		41,275			2,65	4T-64433	29	NTN
110,000	150,000	20,500	15,500	20,500	0,98	CR-2256	29	NTN
	150,000	25,000	20,000	25,000	1,24	32922X	29	NTN
	150,000	150,000			7,70	CR0-2252	32	NTN
	160,000	57,500			3,41	CRI-2258	30	NTN
	165,000	35,000	26,500	35,000	2,52	4T-JM822049/JM822010	29	NTN
	170,000	38,000	29,000	38,000	3,10	32022 A	29	SNR
	170,000	38,000	29,000	38,000	3,07	32022X	29	NTN
	170,000	47,000	37,000	47,000	3,47	33022	29	NTN
	170,000	47,000	37,000	47,000	3,90	33022 A	29	SNR
	180,000	41,275	30,162	41,275	3,91	4T-64432/64708	29	NTN
	180,000	46,000	38,000	47,000	4,61	4T-JHM522649/JHM522610	29	NTN
	180,000	56,000	43,000	56,000	5,52	33122	29	NTN
	180,000	56,000			5,60	323122	31	NTN
	180,000	56,000			5,20	413122	30	NTN
	180,000	70,000			6,28	423122	30	NTN
	180,000	125,000			11,20	CRI-2219	30	NTN
	190,000	102,000			12,10	CRD-2252	31	NTN
	190,000	249,400			24,50	CR1-2290LL	30	NTN
	200,000	38,000	32,000	41,000	5,00	30222	29	NTN
	200,000	38,000	32,000	41,000	5,14	30222 A	29	SNR
	200,000	48,000	32,000	51,000	5,69	CR-2226	29	NTN
	200,000	53,000	46,000	56,000	7,43	32222	29	NTN
	200,000	53,000	46,000	56,000	7,46	32222 A	29	SNR
	200,000	82,000			11,30	CRD-2254	31	NTN
	200,000	92,000			11,40	430222XU	30	NTN
	200,000	100,000			13,60	CR1-2272LL	30	NTN



							 Brands		
d	D	B	C	T	Kg	Reference			
110,000	200,000	112,000			13,70	4T-32222DF	30	NTN	
	200,000	112,000			15,40	32222UDF	30	NTN	
	200,000	121,000			14,80	43222XU	30	NTN	
	240,000	50,000	32,000	54,500	8,12	CR-2220	29	NTN	
	240,000	50,000	42,000	54,500	11,10	30322	29	NTN	
	240,000	57,000	38,000	63,000	11,90	31322X	29	NTN	
	240,000	80,000	65,000	84,500	18,00	32322	29	NTN	
	240,000	118,000			26,60	CRD-2214	31	NTN	
	240,000	118,000			22,00	CRI-2262	30	NTN	
	240,000	118,000			22,10	430322	30	NTN	
	240,000	118,000			24,50	430322U	30	NTN	
	240,000	119,000			25,00	CRI-2252	30	NTN	
	240,000	126,000			25,90	31322XUDF	30	NTN	
	240,000	169,000			37,00	32322DF	30	NTN	
	240,000	181,000			35,60	432322	30	NTN	
	240,000	181,000			38,20	432322U	30	NTN	
		35,000				1,68	4T-JM822049	29	NTN
		46,000				3,10	4T-JHM522649	29	NTN
111,125	190,500	106,362			11,70	4T-71437/71751D+A	30	NTN	
	214,312	52,388	39,688	55,562	8,18	4T-H924045/H924010	29	NTN	
	214,312	52,388	107,950	115,888	17,30	4T-H924045/H924010D	30	NTN	
	241,300	158,750			31,80	E-HH924349/HH924310D+A	30	NTN	
	241,300	158,750			32,00	4T-HH924349/HH924310D+A	30	NTN	
114,300	177,800	41,275	30,162	41,275	3,52	4T-64450/64700	29	NTN	
	177,800	92,075			7,74	4T-64450/64700CD+A	30	NTN	
	177,800	92,075			7,64	4T-64450/64700D+A	30	NTN	
	190,500	49,212	34,925	49,212	5,17	4T-71450/71750	29	NTN	
	190,500	106,362			11,10	4T-NA71450/71751D	30	NTN	
	212,725	66,675	53,975	66,675	10,20	4T-HH224346/HH224310	29	NTN	
	212,725	66,675	53,975	66,675	10,10	4T-938/932	29	NTN	
	212,725	142,875			20,20	4T-HH224346NA/HH224310D	30	NTN	
	212,725	142,875			20,00	4T-938/932D+A	30	NTN	
	228,600	49,428	38,100	53,975	9,76	4T-HM926740/HM926710	29	NTN	
	228,600	115,888			21,10	4T-HM926740/HM926710D+A	30	NTN	
	273,050	82,550	53,975	82,550	22,20	T-HH926744/HH926710	29	NTN	
	279,400	82,550	53,975	82,550	23,50	T-HH926744/HH926716	29	NTN	
		31,750			1,88	4T-68450	29	NTN	
		41,275			2,37	4T-64450	29	NTN	
		49,212			3,39	4T-71450	29	NTN	
		49,428			6,95	4T-HM926740	29	NTN	
		66,675			7,13	4T-HH224346	29	NTN	
	66,675			6,00	4T-938	29	NTN		
115,000	230,000	116,000			21,20	CRI-2301	30	NTN	
115,087	190,500	49,212	34,925	47,625	5,11	4T-71453/71750	29	NTN	
	190,500	106,362			11,10	4T-71453/71751D+A	30	NTN	
	190,500	106,362			11,10	4T-71453/71751DC+A	30	NTN	
117,475	180,975	31,750	25,400	34,925	2,76	4T-68462/68712	29	NTN	
		31,750			1,72	4T-68462	29	NTN	
120,000	165,000	29,000	23,000	29,000	1,77	32924X	29	NTN	
	165,000	68,000			3,97	CR1-2498	30	NTN	
	170,000	25,000	19,500	27,000	1,69	T4CB 120	29	SNR	
	170,000	25,000	19,500	27,000	1,69	4T-T4CB120	29	NTN	
	170,000	120,000			8,57	CRD-2421	31	NTN	
	170,000	124,000			8,97	625924	32	NTN	
	170,000	124,000			8,97	E-625924	32	NTN	
180,000	38,000	29,000	38,000	3,31	32024 A	29	SNR		



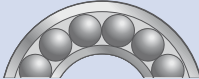



								Brands
d	D	B	C	T	Kg	Reference		
120,000	180,000	38,000	29,000	38,000	3,40	32024X	29	NTN
	180,000	46,000			4,08	323024	31	NTN
	180,000	46,000			3,85	413024	30	NTN
	180,000	48,000	29,000	48,000	7,10	CR-2465	29	NTN
	180,000	48,000	38,000	48,000	4,10	33024	29	NTN
	180,000	48,000	38,000	48,000	4,28	33024 A	29	SNR
	180,000	48,000	38,000	48,000	4,32	33024 VC12	29	SNR
	180,000	58,000			4,41	423024	30	NTN
	180,000	76,000			6,73	4T-32024XDF	30	NTN
	180,000	76,000			6,80	32024XUDF	30	NTN
	180,000	100,000			8,87	623024	32	NTN
	200,000	62,000			7,82	323124	31	NTN
	200,000	62,000			7,20	413124	30	NTN
	200,000	78,000			8,78	CRI-2460	30	NTN
	200,000	78,000			8,96	423124	30	NTN
	200,000	100,000			12,57	CR1-2416	30	NTN
	200,000	100,000			12,60	CRI-2416	30	NTN
	200,000	132,000			16,70	623124	32	NTN
	210,000	174,000			22,20	CRO-2418	32	NTN
	215,000	40,000	34,000	43,500	6,23	30224	29	NTN
	215,000	40,000	34,000	43,500	6,25	30224 A	29	SNR
	215,000	58,000	50,000	61,500	8,98	32224	29	NTN
	215,000	58,000	50,000	61,500	9,28	32224 A	29	SNR
	215,000	87,000			13,10	30224UDF	30	NTN
	215,000	97,000			13,60	430224XU	30	NTN
	215,000	113,000			17,70	CRD-2420	31	NTN
	215,000	123,000			18,30	32224UDF	30	NTN
	215,000	132,000			18,90	432224XU	30	NTN
	260,000	55,000	34,000	59,500	12,40	CR-2417	29	NTN
	260,000	55,000	46,000	59,500	14,20	30324	29	NTN
	260,000	62,000	42,000	68,000	15,90	31324X	29	NTN
	260,000	86,000	69,000	90,500	22,40	32324	29	NTN
	260,000	128,000			30,50	430324XU	30	NTN
	260,000	130,000			34,20	CRD-2410	31	NTN
	260,000	136,000			31,80	31324XUDF	30	NTN
260,000	188,000			47,00	432324U	30	NTN	
280,000	150,000			47,30	CRD-2422	31	NTN	
120,650	160,338	21,433	16,670	21,433	1,15	4T-L624549/L624510	29	NTN
	174,625	77,788			5,76	4T-M224749/M224710D+A	30	NTN
	174,625	141,288			11,50	M224749D/M224710/M224710D	32	NTN
	206,375	107,950			13,30	4T-795/792D	30	NTN
	206,375	107,950			13,30	4T-795/792D+A	30	NTN
	210,000	174,000			22,20	E-CRO-2418	32	NTN
	234,950	63,500	49,212	63,500	12,60	4T-95475/95925	29	NTN
	254,000	82,550	61,912	77,788	19,20	4T-HH228340/HH228310	29	NTN
	273,050	82,550	53,975	82,550	22,00	4T-HH926749/HH926710	29	NTN
	273,050	82,550	53,975	82,550	21,70	T-HH926749/HH926710	29	NTN
		47,625			4,45	4T-795	29	NTN
		63,500			8,56	4T-95475	29	NTN
		82,550			12,58	4T-HH228340	29	NTN
123,825	182,562	38,100	33,338	39,688	3,52	4T-48286/48220	29	NTN
	204,775	60,325	45,237	55,562	7,13	E-HM125948/HM125910	29	NTN
		38,100			2,38	4T-48286	29	NTN
		82,550			12,30	4T-HH228344	29	NTN
125,000	210,000	110,000			14,50	CRI-2555	30	NTN
	230,000	116,000			19,00	4T-CR1-2554	30	NTN
	230,000	116,000			19,90	CRI-2554	30	NTN
	305,000	180,000			68,90	CRD-2503	31	NTN
	305,000	180,000			63,90	CR-2503DF	30	NTN



							 Brands		
d	D	B	C	T	Kg	Reference			
127,000	165,895	17,462	13,495	18,258	0,92	4T-LL225749/LL225710	29	NTN	
	169,862	26,195	20,638	25,400	1,58	4T-L225849/L225810	29	NTN	
	174,625	141,288			11,50	E-M224749D/M224710/M224710D	32	NTN	
	182,562	38,100	33,338	39,688	3,33	4T-48290/48220	29	NTN	
	182,562	85,725			7,77	4T-NA48291/48220D	30	NTN	
	182,562	93,660			8,49	4T-NA48290SW/48220D	30	NTN	
	182,562	158,750			14,30	T-48290D/48220/48220D	32	NTN	
	196,850	46,038	38,100	46,038	5,10	4T-67388/67322	29	NTN	
	196,850	101,600			10,10	4T-67388/67322D+A	30	NTN	
	206,375	107,950			12,58	NA798/792D	30	NTN	
	215,900	47,625	34,925	47,625	7,05	4T-74500/74850	29	NTN	
	215,900	106,362			15,50	4T-74500/74851D+A	30	NTN	
	228,600	49,428	38,100	53,975	8,70	4T-HM926747/HM926710	29	NTN	
	228,600	49,428	38,100	53,975	8,43	4T-97500/97900	29	NTN	
	234,950	63,500	49,212	63,500	11,96	4T-95500/95925	29	NTN	
	234,950	142,875			24,60	NA95500/95927D	30	NTN	
	234,950	142,875			26,30	4T-95500/95927D+A	30	NTN	
	254,000	82,550	61,912	77,788	18,40	4T-HH228349/HH228310	29	NTN	
	266,700	58,738			17,70	CRT2503	37	NTN	
	295,275	87,312	57,150	82,550	27,10	T-HH231637/HH231615	29	NTN	
	304,800	82,550	57,150	88,900	32,80	T-HH932132/HH932110	29	NTN	
		26,195			1,02	4T-L225849	29	NTN	
		38,100			2,10	4T-48290	29	NTN	
		46,038			3,64	4T-67388	29	NTN	
		49,428			6,02	4T-HM926747	29	NTN	
		63,500			7,95	4T-95500	29	NTN	
		82,550			13,46	4T-HH228349	29	NTN	
	127,792	228,600	115,888			18,70	4T-HM926749/HM926710D+A	30	NTN
	128,000	229,000	116,000			17,80	CRI-2663	30	NTN
	128,588	206,375	47,625	34,925	47,625	5,77	4T-799/792	29	NTN
		47,625			3,87	4T-799	29	NTN	
130,000	180,000	32,000	25,000	32,000	2,36	32926X	29	NTN	
	180,000	64,000			4,90	32926DF	30	NTN	
	182,562	158,750			14,30	T-E-48290D/48220/48220D	32	NTN	
	184,000	134,000			11,30	625926	32	NTN	
	190,000	120,000			11,40	CRD-2652	31	NTN	
	195,000	120,000			12,50	CRD-2654	31	NTN	
	200,000	45,000	34,000	45,000	5,13	32026 A	29	SNR	
	200,000	45,000	34,000	45,000	4,96	32026X	29	NTN	
	200,000	52,000			5,92	323026	31	NTN	
	200,000	52,000			5,55	413026	30	NTN	
	200,000	65,000			6,62	423026	30	NTN	
	200,000	90,000			10,26	32026XUDF	30	NTN	
	210,000	64,000			8,58	323126	31	NTN	
	210,000	64,000			7,83	413126	30	NTN	
	210,000	80,000			9,77	423126	30	NTN	
	210,000	109,000			14,20	CRI-2619	30	NTN	
	214,000	115,000			15,50	CRI-2651	30	NTN	
	230,000	40,000	34,000	43,750	7,00	30226	29	NTN	
	230,000	40,000	34,000	43,750	7,16	30226 A	29	SNR	
	230,000	64,000	54,000	67,750	10,70	32226	29	NTN	
	230,000	64,000	54,000	67,750	11,50	32226 A	29	SNR	
	230,000	95,000			15,00	CRI-2614	30	NTN	
	230,000	98,000			15,01	430226XU	30	NTN	
	230,000	100,000			15,80	CRI-2655	30	NTN	
	230,000	135,500			23,00	32226UDF	30	NTN	
	230,000	145,000			23,00	CRI-2616	30	NTN	
	230,000	145,000			23,00	432226XU	30	NTN	



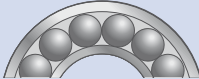



								Brands
d	D	B	C	T	Kg	Reference		
130,000	230,000	149,000			24,60	CRI-2654	30	NTN
	280,000	58,000	36,000	63,750	15,20	CR-2615	29	NTN
	280,000	58,000	49,000	63,750	17,10	30326	29	NTN
	280,000	66,000	44,000	72,000	19,00	31326X	29	NTN
	280,000	93,000	78,000	98,750	27,20	32326	29	NTN
	280,000	137,000			33,70	CRI-2618	30	NTN
	280,000	137,000			34,50	CRI-2618	30	NTN
	280,000	137,000			37,90	430326XU	30	NTN
	280,000	144,000			41,00	31326XUDF	30	NTN
	280,000	205,000			56,60	432326	30	NTN
	280,000	220,500			37,50	CR-2615DF	30	NTN
	299,000	137,000			43,70	CR1-2624	30	NTN
299,000	137,000			45,80	CRI-2624	30	NTN	
130,175	196,850	46,038	38,100	46,038	4,87	4T-67389/67322	29	NTN
	206,375	47,625	34,925	47,625	5,65	4T-799A/792	29	NTN
131,750	207,962	129,550	135,900	190,500	20,00	E-CR1-2648LL	30	NTN
133,350	177,008	26,195	20,638	25,400	1,70	4T-L327249/L327210	29	NTN
	190,500	39,688	33,338	39,688	3,64	4T-48385/48320	29	NTN
	196,850	46,038	38,100	46,038	4,63	4T-67390/67322	29	NTN
	196,850	46,038	38,100	46,038	4,59	4T-67391/67322	29	NTN
	196,850	101,600			9,91	4T-67390/67322D+A	30	NTN
	196,850	101,600			9,37	4T-67391/67322D+A	30	NTN
	215,900	47,625	34,925	47,625	6,56	4T-74525/74850	29	NTN
	215,900	106,362			13,50	NA74525/74851D	30	NTN
	215,900	106,362			13,90	4T-74525/74851D+A	30	NTN
	234,950	63,500	49,212	63,500	11,30	4T-95525/95925	29	NTN
	234,950	142,875			23,60	4T-95525/95927D+A	30	NTN
		26,195			1,15	4T-L327249	29	NTN
		39,688			2,47	4T-48385	29	NTN
		46,038			2,20	4T-67390	29	NTN
		46,038			3,13	4T-67391	29	NTN
	47,625			4,60	4T-74525	29	NTN	
	63,500			7,27	4T-95525	29	NTN	
135,000	180,000	160,000			13,50	CRO-2701	32	NTN
135,000	184,000	134,000			11,30	E-625926	32	NTN
136,525	180,000	160,000			13,50	E-CRO-2701	32	NTN
	190,500	39,688	33,338	39,688	3,43	4T-48393/48320	29	NTN
	190,500	85,725			7,23	4T-NA48390/48320D	30	NTN
	190,500	85,725			7,40	4T-48393/48320D+A	30	NTN
	190,500	161,925			14,80	T-48393D/48320/48320D	32	NTN
	228,600	57,150	44,450	57,150	9,07	4T-896/892	29	NTN
		39,688			2,26	4T-48393	29	NTN
	57,150			5,94	4T-896	29	NTN	
139,700	190,500	161,925			14,80	T-E-48393D/48320/48320D	32	NTN
	200,025	157,165			17,30	T-48680D/48620/48620D	32	NTN
	214,975	47,625	34,925	47,625	5,97	4T-74550/74845	29	NTN
	215,900	47,625	34,925	47,625	6,05	4T-74550/74850	29	NTN
	215,900	47,625	34,925	47,625	6,03	4T-74550A/74850	29	NTN
	228,600	57,150	44,450	57,150	8,76	4T-898/892	29	NTN
	236,538	56,642	44,450	57,150	9,86	4T-HM231132/HM231110	29	NTN
	288,925	87,312	57,150	82,550	24,40	T-HH231649/HH231610	29	NTN
	295,275	87,312	57,150	82,550	25,80	T-HH231649/HH231615	29	NTN
	295,275	87,312	57,150	87,312	24,10	HH231649/HH231615	29	NTN
	307,975	93,662	66,675	88,900	30,90	T-HH234031/HH234010	29	NTN
307,975	200,025			65,90	T-HH234031/HH234011D+A	30	NTN	
	47,625			4,10	4T-74550	29	NTN	



							 Brands
d	D	B	C	T	Kg	Reference	
139,700		47,625			4,08	4T-74550A	29 NTN
		57,150			5,63	4T-898	29 NTN
		66,675			5,58	4T-99550	29 NTN
		93,662			22,60	HH234031	29 NTN
140,000	190,000	35,000	25,000	32,000	2,50	32928X	29 NTN
	195,000	27,000	21,000	29,000	2,33	4T-T4CB140	29 NTN
	198,000	144,000			14,00	625928	32 NTN
	198,000	174,000			16,00	CRO-2810LL	32 NTN
	198,000	174,000			15,50	CRO-2812LL	32 NTN
	200,025	157,165			17,30	T-E-48680D/48620/48620D	32 NTN
	210,000	45,000	34,000	45,000	5,39	32028 A	29 SNR
	210,000	45,000	34,000	45,000	5,40	32028X	29 NTN
	210,000	53,000			6,40	323028	31 NTN
	210,000	53,000			5,88	413028	30 NTN
	210,000	55,000	34,000	55,000	4,30	CR-2831	29 NTN
	210,000	56,000	44,000	56,000	6,03	33028	29 NTN
	210,000	66,000			7,11	423028	30 NTN
	210,000	90,000			9,70	32028XUDF	30 NTN
	210,000	106,000			12,60	CRI-2818	30 NTN
	210,000	106,000			12,50	CRI-2818	30 NTN
	210,000	114,000			13,80	623028	32 NTN
	210,000	115,000			13,90	CRO-2817	32 NTN
	225,000	68,000			10,70	323128	31 NTN
	225,000	68,000			9,24	413128	30 NTN
	225,000	84,000			11,80	423128	30 NTN
	225,000	85,000			11,80	CRI-2872	30 NTN
	230,000	120,000			15,50	CRI-2855	30 NTN
	230,000	140,000			20,50	CRI-2825	30 NTN
	240,000	132,000			22,10	CRI-2869	30 NTN
	240,000	132,000			22,10	4T-CR1-2869C3	30 NTN
	250,000	42,000	36,000	45,750	9,26	30228	29 NTN
	250,000	42,000	36,000	45,750	8,87	30228 A	29 SNR
	250,000	68,000	58,000	71,750	14,10	32228	29 NTN
	250,000	68,000	58,000	71,750	14,80	32228 A	29 SNR
	250,000	102,000			19,90	430228XU	30 NTN
	250,000	143,500			29,00	32228UDF	30 NTN
	250,000	153,000			30,10	CRI-2884L	30 NTN
	250,000	153,000			30,10	432228XU	30 NTN
	260,000	120,000			26,60	CRI-2826	30 NTN
	270,000	120,000			27,60	CRI-2874	30 NTN
	300,000	62,000	53,000	67,750	21,10	30328	29 NTN
	300,000	70,000	47,000	77,000	23,00	31328X	29 NTN
	300,000	102,000	85,000	107,750	32,90	32328	29 NTN
	300,000	102,000			32,50	CRI-2834	30 NTN
300,000	102,000			32,50	CRI-2834	30 NTN	
300,000	145,000			46,60	430328XU	30 NTN	
300,000	154,000			49,70	31328XUDF	30 NTN	
305,000	160,000			58,10	CRD-2819	31 NTN	
142,875	193,675	65,085			5,12	4T-36686/36620D	30 NTN
	200,025	39,688	34,130	41,275	3,85	4T-48684/48620	29 NTN
	200,025	39,688	34,130	41,275	3,89	4T-48685/48620	29 NTN
	200,025	87,315			8,18	4T-48685/48620DC+A	30 NTN
	200,025	93,665			1,20	4T-NA48685SW/48620D	30 NTN
		39,688			2,46	4T-48684	29 NTN
	39,688			2,50	4T-48685	29 NTN	
146,050	193,675	28,575	23,020	28,575	2,25	4T-36690/36620	29 NTN
	198,000	144,000			14,00	E-625928	32 NTN
	236,538	131,762			20,08	NA82576/82932D	30 NTN
	236,538	131,762			20,10	82576/82932D+A	30 NTN



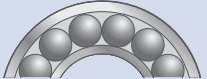



								Brands	
d	D	B	C	T	Kg	Reference			
146,050	244,475	192,088			36,80	81576D/81962/81963D	32	NTN	
	254,000	66,675	47,625	66,675	13,50	4T-99575/99100	29	NTN	
	268,288	160,338			37,80	E-E07057/107105CD+A	30	NTN	
	304,800	82,550	57,150	88,900	30,60	T-HH932145/HH932110	29	NTN	
	311,150	82,550	57,150	88,900	32,20	T-HH932145/HH932115	29	NTN	
		28,575			3,10	4T-36690	29	NTN	
149,225	236,538	56,642	44,450	57,150	8,94	4T-HM231149/HM231110	29	NTN	
	240,000	56,642	44,450	57,150	9,40	4T-82587/J82945	29	NTN	
150,000	210,000	38,000	30,000	38,000	3,92	32930X	29	NTN	
	210,000	76,000			8,02	32930XUDF	30	NTN	
	210,000	190,000			20,30	CR0-3052	32	NTN	
	210,000	190,000			21,08	CR0-3058	32	NTN	
	212,000	155,000			16,90	625930	32	NTN	
	225,000	48,000	36,000	48,000	6,46	32030 A	29	SNR	
	225,000	48,000	36,000	48,000	6,40	32030X	29	NTN	
	225,000	56,000			7,76	323030	31	NTN	
	225,000	56,000			6,66	413030	30	NTN	
	225,000	59,000	46,000	59,000	8,07	33030	29	NTN	
	225,000	70,000			8,42	423030	30	NTN	
	244,475	192,088			36,80	E-81576D/81962/81963D	32	NTN	
	250,000	80,000			15,70	323130	31	NTN	
	250,000	80,000			14,30	413130	30	NTN	
	250,000	100,000			18,00	423130	30	NTN	
	250,000	110,000			21,70	CRD-3052	31	NTN	
	250,000	115,000			21,20	CRI-3015	30	NTN	
	250,000	137,000			27,70	CRI-3061	30	NTN	
	260,000	150,000			31,40	CRI-3063	30	NTN	
	270,000	45,000	38,000	49,000	10,90	30230	29	NTN	
	270,000	45,000	38,000	49,000	11,20	30230 A	29	SNR	
	270,000	73,000	60,000	77,000	17,80	32230	29	NTN	
	270,000	73,000	60,000	77,000	18,50	32230 A	29	SNR	
	270,000	109,000			24,40	430230U	30	NTN	
	270,000	154,000			36,92	32230UDF	30	NTN	
	270,000	164,000			8,40	432230XU	30	NTN	
	320,000	65,000	55,000	72,000	25,50	30330	29	NTN	
	320,000	75,000	50,000	82,000	27,70	31330X	29	NTN	
	320,000	108,000	90,000	114,000	42,00	32330	29	NTN	
	320,000	144,000			56,90	CRD-3013	31	NTN	
	320,000	144,000			53,00	CRD-3016	31	NTN	
	320,000	154,000			52,80	430330	30	NTN	
	320,000	154,000			55,40	430330U	30	NTN	
	380,000	235,000			142,00	CRD-3011	31	NTN	
	380,000	260,000			146,00	CR1-3069	30	NTN	
	152,400	192,088	24,000	19,000	25,000	1,53	4T-L630349/L630310	29	NTN
		212,000	155,000			16,90	E-625930	32	NTN
		222,250	46,830	34,925	46,830	5,72	4T-M231648/M231610	29	NTN
222,250		46,830	34,925	46,830	5,77	4T-M231649/M231610	29	NTN	
222,250		174,625			24,70	E-M231649D/M231610/M231610D	32	NTN	
222,250		174,625			24,70	T-M231649D/M231610/M231610D	32	NTN	
254,000		66,675	47,625	66,675	12,78	4T-99600/99100	29	NTN	
254,000		142,875			27,40	4T-NA99600/99102D	30	NTN	
254,000		149,225			27,46	4T-99600/99102CD	30	NTN	
307,975		93,662	61,912	88,900	29,40	T-EE450601/451212	29	NTN	
307,975		93,662	66,675	88,900	29,40	E-HH234048/HH234010	29	NTN	
307,975		93,662	66,675	88,900	29,40	T-HH234048/HH234010	29	NTN	
307,975		93,662	66,675	93,662	28,10	HH234048/HH234010	29	NTN	
307,975		171,450			60,50	T-450900D/451212+A	31	NTN	
307,975		200,025			62,60	T-HH234048/HM234011D+A	30	NTN	
307,975		200,025			62,60	T-EE450601/451215D+A	30	NTN	







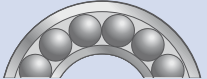

							 Brands	
d	D	B	C	T	Kg	Reference		
152,400	317,500	69,850			28,20	E-CRT3018	37	NTN
		46,830			3,89	4T-M231649	29	NTN
		66,675			8,52	4T-99600	29	NTN
	210,000	90,000			8,13	CR-3105DB	30	NTN
155,000	330,000	180,000			66,00	CRI-3101	30	NTN
155,575	330,200	79,375	53,975	85,725	34,90	T-H936340/H936310	29	NTN
	330,200	171,450			62,90	H936340/H936310DF	30	NTN
	342,900	79,375	53,975	85,725	38,40	T-H936340/H936316	29	NTN
158,750	205,583	23,812	18,258	23,812	1,89	4T-L432349/L432310	29	NTN
	225,425	39,688	33,338	41,275	5,20	4T-46780/46720	29	NTN
	225,425	85,725			10,80	4T-46780/46720D+A	30	NTN
	304,800	69,106	42,862	66,675	20,80	EE280626/281200	29	NTN
		23,812			1,40	4T-L432349	29	NTN
		39,688			3,54	4T-46780	29	NTN
160,000	220,000	38,000	30,000	38,000	4,14	32932X	29	NTN
	222,250	174,625			24,70	T-E-M231649D/M231610/M231610D	32	NTN
	226,000	165,000			20,20	625932	32	NTN
	226,000	165,000			20,20	E-625932	32	NTN
	240,000	51,000	38,000	51,000	7,87	32032 A	29	SNR
	240,000	51,000	38,000	51,000	7,80	32032X	29	NTN
	240,000	60,000			9,46	323032	31	NTN
	240,000	60,000			8,29	413032	30	NTN
	240,000	75,000			10,70	423032	30	NTN
	240,000	110,000			17,30	CRD-3254	31	NTN
	240,000	110,000			15,60	CRI-3256	30	NTN
	260,000	130,000			26,50	CRD-3253	31	NTN
	265,000	173,000			37,00	CRO-3209 (CRO-3210)	32	NTN
	270,000	86,000			20,00	323132	31	NTN
	270,000	86,000			18,10	413132	30	NTN
	270,000	86,000			18,20	413132	30	NTN
	270,000	108,000			22,10	423132	30	NTN
	270,000	108,000			22,80	423132	30	NTN
	270,000	110,000			22,90	CRI-3210	30	NTN
	270,000	116,000			27,10	CRD-3208	31	NTN
	270,000	140,000			32,00	CR1-3201	30	NTN
	270,000	140,000			31,80	CR1-3225	30	NTN
	270,000	140,000			31,80	CRI-3225	30	NTN
	270,000	150,000			32,80	CRI-3219	30	NTN
	280,000	150,000			34,80	CRI-3258	30	NTN
	290,000	48,000	40,000	52,000	12,90	30232	29	NTN
	290,000	80,000	67,000	84,000	23,60	32232	29	NTN
	290,000	80,000	67,000	84,000	22,50	32232 A	29	SNR
	290,000	115,000			31,90	430232U	30	NTN
	290,000	168,000			48,30	32232UDF	30	NTN
	290,000	178,000			46,90	432232U	30	NTN
	290,000	200,000			56,90	CR1-3266	30	NTN
	340,000	68,000	58,000	75,000	29,90	30332	29	NTN
	340,000	114,000	95,000	121,000	48,50	32332	29	NTN
	340,000	150,000			63,30	30332UDF	30	NTN
	340,000	160,000			65,50	430332XU	30	NTN
340,000	242,000			101,00	32332DF	30	NTN	
160,325	288,925	63,500	47,625	63,500	16,00	T-HM237532/HM237510	29	NTN
	288,925	142,875			36,10	T-HM237532/HM237510D+A	30	NTN
161,925	374,650	79,375	60,325	87,312	47,90	EE117063/117148	29	NTN
165,000	290,000	150,000			37,50	CRI-3309	30	NTN

								Brands
d	D	B	C	T	Kg	Reference		
165,000	350,000	146,000			61,20	CRI-3305	30	NTN
165,100	215,900	26,195	20,638	26,195	2,33	4T-L433749/L433710	29	NTN
	225,425	39,688	33,338	41,275	4,69	4T-46790/46720	29	NTN
	225,425	85,725			9,72	4T-46790/46720D+A	30	NTN
	225,425	95,250			9,87	4T-NA46790SW/46720CD	30	NTN
	225,425	165,100			20,70	T-46791D/46720/46721D	32	NTN
	225,425	165,100			20,70	T-E-46791D/46720/46721D	32	NTN
	247,650	103,880			17,06	4T-67780/67720D+A	30	NTN
	254,000	46,038	33,338	46,038	7,43	86650/86100	29	NTN
	265,000	173,000			33,60	E-CRO-3209	32	NTN
	288,925	63,500	47,625	63,500	16,60	HM237535/HM237510	29	NTN
	288,925	63,500	47,625	63,500	15,60	T-HM237535/HM237510	29	NTN
	288,925	63,500	47,625	63,500	17,10	T-94649/94113	29	NTN
	288,925	142,875			35,10	T-HM237535/HM237510D+A	30	NTN
	288,925	142,875			35,10	T-94649/94114D+A	30	NTN
	311,150	82,550	65,088	82,550	27,50	T-H238140/H238110	29	NTN
	336,550	95,250	69,850	92,075	36,60	T-HH437549/HH437510	29	NTN
		39,688			3,04	4T-46790	29	NTN
		82,550			17,30	E-H238140	29	NTN
168,275	330,200	79,375	53,975	85,725	33,20	T-H936349/H936310	29	NTN
	330,200	171,450			62,50	H936349/H936310DF	30	NTN
170,000	230,000	38,000	30,000	38,000	4,40	32934X	29	NTN
	230,000	38,000	31,000	39,000	4,37	4T-JHM534149/JHM534110	29	NTN
	240,000	44,501	37,000	46,000	6,23	4T-JM734449/JM734410	29	NTN
	240,000	84,000			12,00	CRTD3401	38	NTN
	240,000	175,000			24,40	625934	32	NTN
	240,000	175,000			24,40	E-625934	32	NTN
	250,000	85,000			12,60	CRI-3420	30	NTN
	250,000	85,000			12,60	CRI-3420	30	NTN
	260,000	57,000	43,000	57,000	10,60	32034 A	29	SNR
	260,000	57,000	43,000	57,000	10,50	32034X	29	NTN
	260,000	67,000	43,000	67,000	11,48	CR-3418	29	NTN
	260,000	67,000			12,80	323034	31	NTN
	260,000	67,000			11,60	413034	30	NTN
	260,000	84,000			13,90	423034	30	NTN
	260,000	144,000			27,50	623034	32	NTN
	280,000	76,000			18,50	CRD-3413	31	NTN
	280,000	88,000			21,50	323134	31	NTN
	280,000	88,000			21,40	323134	31	NTN
	280,000	88,000			18,90	413134	30	NTN
	280,000	88,000			19,50	413134	30	NTN
	280,000	110,000			23,00	423134	30	NTN
	280,000	110,000			24,70	423134	30	NTN
	280,000	134,000			32,80	CRI-3452	30	NTN
	280,000	150,000			32,70	CR1-3410	30	NTN
	280,000	150,000			34,30	CRI-3410	30	NTN
	280,000	181,000			44,00	CRO-3409	32	NTN
	280,000	181,000			44,00	E-CRO-3409	32	NTN
	280,000	185,000			45,20	623134	32	NTN
	300,000	100,000			30,20	CRD-3423	31	NTN
	310,000	52,000	43,000	57,000	17,00	30234	29	NTN
	310,000	86,000	71,000	91,000	28,70	32234	29	NTN
	310,000	86,000	71,000	91,000	29,30	32234 A	29	SNR
	310,000	125,000			38,00	430234U	30	NTN
	310,000	182,000			60,50	32234UDF	30	NTN
	310,000	192,000			60,40	432234XU	30	NTN
	360,000	72,000	62,000	80,000	35,30	30334	29	NTN
	360,000	75,000	46,000	83,000	34,20	CR-3463	29	NTN
	360,000	120,000	100,000	127,000	56,50	32334	29	NTN





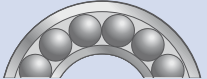



							 Brands	
d	D	B	C	T	Kg	Reference		
170,000	360,000	144,000			79,70	CRD-3414	31	NTN
	360,000	160,000			71,90	CRD-3416	31	NTN
		38,000			3,07	4T-JHM534149	29	NTN
		44,501			4,24	4T-JM734449	29	NTN
174,625	247,650	47,625	38,100	47,625	7,00	4T-67786/67720	29	NTN
	247,650	47,625	38,100	47,625	7,00	4T-67787/67720	29	NTN
	247,650	103,188			15,10	4T-67787/67720DC+A	30	NTN
	288,925	63,500	47,625	63,500	14,70	T-HM237542/HM237510	29	NTN
	288,925	63,500	47,625	63,500	14,70	T-94687/94113	29	NTN
	288,925	142,875			33,10	T-HM237542/HM237510D+A	30	NTN
	288,925	142,875			33,10	T-94687/94114D+A	30	NTN
	298,450	82,550	63,500	82,550	21,10	T-EE219068/219117	29	NTN
	311,150	82,550	63,500	82,550	23,90	T-EE219068/219122	29	NTN
	311,150	82,550	65,088	82,550	26,00	E-H238148/H238110	29	NTN
	311,150	82,550	65,088	82,550	23,90	T-H238148/H238110	29	NTN
	358,775	82,550			43,40	CRT3503	37	NTN
	358,775	82,550			43,40	E-CRT3503	37	NTN
		47,625			4,49	4T-67786	29	NTN
		47,625			4,54	4T-67787	29	NTN
	177,000	248,000	90,488			13,45	CRD-3502	31
177,800	215,900	20,638	15,083	20,638	1,40	LL735449/LL735410	29	NTN
	215,900	20,638	15,083	20,638	1,40	4T-LL735449/LL735410	29	NTN
	227,012	30,162	23,020	30,162	2,92	4T-36990/36920	29	NTN
	227,012	66,672			6,30	4T-36990/36920CD+A	30	NTN
	247,650	47,625	38,100	47,625	6,57	4T-67790/67720	29	NTN
	247,650	103,188			14,30	4T-67790/67720CD+A	30	NTN
	247,650	192,088			29,40	E-67791D/67720/67721D	32	NTN
	247,650	192,088			29,40	67791D/67720/67721D (CRO-3664)	32	NTN
	260,350	53,975	41,275	53,975	9,28	E-M236848/M236810	29	NTN
	260,350	53,975	41,275	53,975	9,34	4T-M236849/M236810	29	NTN
	279,400	133,353			28,20	82680X/82620D	30	NTN
	279,400	234,950			55,30	82681D/82620/82620D	32	NTN
	279,400	234,950			55,30	E-82681D/82620/82620D	32	NTN
	288,925	63,500	47,625	63,500	14,40	T-HM237545/HM237510	29	NTN
	288,925	63,500	47,625	63,500	14,40	T-94700/94113	29	NTN
	288,925	123,825			29,40	HM237546D/HM237510+A	31	NTN
	288,925	123,825			31,60	T-HM237546D/HM237510+A	30	NTN
	288,925	123,825			31,60	T-94706D/94113+A	30	NTN
	288,925	142,875			32,10	HM237545/HM237510D+A	30	NTN
	288,925	142,875			32,96	E-HM237545/HM237510DC+A	30	NTN
	288,925	142,875			32,40	T-HM237545/HM237510D+A	30	NTN
	288,925	142,875			32,70	HM237545NA/HM237510CD	30	NTN
	288,925	142,875			52,51	NA94700/94114D	30	NTN
	288,925	142,875			32,40	T-94700/94114D+A	30	NTN
	289,974	63,500	48,000	63,500	14,60	T-HM237545/HM237513	29	NTN
	304,800	238,227			69,90	E-EE280700D/281200/281201D	32	NTN
	304,800	238,227			69,90	EE280700D/281200/281201D (CRO-3663)	32	NTN
	304,800	238,227			67,30	CRO-3663	32	NTN
	319,964	85,725	65,088	88,900	28,00	H239640/H239610	29	NTN
	319,964	85,725	65,088	88,900	30,20	T-H239640/H239610	29	NTN
	320,675	185,738			57,80	EE222070/222127D+A	30	NTN
	320,675	185,738			57,80	T-H239640/H239612D+A	30	NTN
	368,300	82,550			48,30	E-CRT3614	37	NTN
	368,300	82,550			45,30	E-CRT3617	37	NTN
	428,625	95,250	61,912	106,362	77,70	EE350701/351687	29	NTN
		30,162			2,00	4T-36990	29	NTN
		47,625			4,21	4T-67790	29	NTN
		53,975			6,48	4T-M236849	29	NTN

								Brands	
d	D	B	C	T	Kg	Reference			
180,000	250,000	45,000	34,000	45,000	6,48	32936X	29	NTN	
	250,000	45,000	37,000	47,000	6,72	4T-JM736149/JM736110	29	NTN	
	250,000	185,000			27,50	CRO-3658	32	NTN	
	254,000	185,000			28,90	625936	32	NTN	
	254,000	185,000			28,90	E-625936	32	NTN	
	260,000	185,000			32,30	CRO-3666	32	NTN	
	280,000	64,000	48,000	64,000	14,20	32036 A	29	SNR	
	280,000	64,000	48,000	64,000	14,50	32036X	29	NTN	
	280,000	74,000			16,50	323036	31	NTN	
	280,000	74,000			13,40	413036	30	NTN	
	280,000	74,000			15,90	413036	30	NTN	
	280,000	93,000			18,50	423036	30	NTN	
	280,000	93,000			19,00	423036	30	NTN	
	280,000	134,500			27,00	CRI-3623	30	NTN	
	300,000	96,000			27,20	323136	31	NTN	
	300,000	96,000			24,60	413136	30	NTN	
	300,000	120,000			31,40	423136	30	NTN	
	300,000	120,000			31,40	423136	30	NTN	
	300,000	164,000			43,70	CRI-3625	30	NTN	
	300,000	280,000			69,40	CRO-3617	32	NTN	
	300,000	280,000			69,40	E-CRO-3617	32	NTN	
	317,500	63,500	46,038	63,500	19,00	T-93708/93125	29	NTN	
	320,000	52,000	43,000	57,000	17,70	30236	29	NTN	
	320,000	86,000	71,000	91,000	30,10	32236	29	NTN	
	320,000	86,000	71,000	91,000	30,70	32236 A	29	SNR	
	320,000	127,000			37,50	430236	30	NTN	
	320,000	127,000			39,40	430236U	30	NTN	
	320,000	182,000			63,50	32236UDF	30	NTN	
	320,000	192,000			60,60	432236U	30	NTN	
	330,000	190,000			71,60	CRD-3615	31	NTN	
	340,000	180,000			67,70	CRI-3618	30	NTN	
	340,000	180,000			68,50	CRI-3618	30	NTN	
	340,000	180,000			68,30	4T-CRI-3618C3	30	NTN	
	380,000	75,000	64,000	83,000	40,20	30336	29	NTN	
	380,000	126,000	106,000	134,000	66,80	32336	29	NTN	
	380,000	158,000			78,70	CRD-3623	31	NTN	
	400,000	232,000			146,50	CRD-3622	31	NTN	
	180,843	284,162	239,715			50,90	E-M240631T/M240644TD/M240647T/M240611D	32	NTN
	187,325	269,875	55,562	42,862	55,562	9,83	M238849/M238810	29	NTN
		269,875	55,562	42,862	55,562	9,83	4T-M238849/M238810	29	NTN
269,875		211,138			41,80	E-M238849D/M238810/M238810D	32	NTN	
269,875		211,138			41,80	M238849D/M238810/M238810D	32	NTN	
282,575		47,625	36,512	50,800	9,73	87737/87111	29	NTN	
282,575		47,625	36,512	50,800	10,90	T-87737/87111	29	NTN	
282,575		107,950			21,10	T-87737/87112D+A	30	NTN	
319,964		85,725	65,088	88,900	28,70	T-H239649/H239610	29	NTN	
319,964		161,925			53,70	T-H239649D/H239610+A	31	NTN	
320,675		85,725	65,088	88,900	28,90	T-H239649/H239612	29	NTN	
320,675		185,738			55,00	T-H239649/H239612D+A	30	NTN	
320,675		185,738			54,60	H239649NA/H239612CD	30	NTN	
		55,562			6,66	4T-M238849	29	NTN	
190,000	260,000	44,000	36,500	46,000	6,78	4T-JM738249/JM738210	29	NTN	
	260,000	45,000	34,000	45,000	6,77	32938X	29	NTN	
	268,000	196,000			34,70	625938	32	NTN	
	268,000	196,000			34,70	E-625938	32	NTN	
	270,000	190,000			34,70	CRO-3812	32	NTN	
	270,000	190,000			34,70	E-CRO-3812	32	NTN	
	270,000	190,000			34,50	CRO-3813	32	NTN	
	290,000	64,000	48,000	64,000	14,57	32038 A	29	SNR	

												 Brands	
d	D	B	C	T	Kg	Reference							
190,000	290,000	64,000	48,000	64,000	14,80	32038X		29	NTN				
	290,000	75,000			17,90	323038		31	NTN				
	290,000	75,000			16,20	413038		30	NTN				
	290,000	94,000			19,10	423038		30	NTN				
	290,000	94,000			19,60	423038		30	NTN				
	292,100	225,425			59,60	E-M241538D/M241510/M241510D		32	NTN				
	292,100	225,425			59,60	M241538D/M241510/M241510D		32	NTN				
	320,000	104,000			34,00	323138		31	NTN				
	320,000	104,000			34,10	CRD-3801		31	NTN				
	320,000	104,000			34,10	CRD-3813		31	NTN				
	320,000	104,000			30,80	413138		30	NTN				
	320,000	130,000			37,30	423138		30	NTN				
	340,000	55,000	46,000	60,000	21,20	30238		29	NTN				
	340,000	92,000	75,000	97,000	36,08	32238		29	NTN				
	340,000	133,000			45,50	430238U		30	NTN				
	340,000	204,000			75,40	CR1-3852		30	NTN				
	340,000	204,000			75,00	432238		30	NTN				
	340,000	204,000			73,30	432238U		30	NTN				
	350,000	135,000			57,70	CRD-3811		31	NTN				
	400,000	78,000	65,000	86,000	43,50	30338		29	NTN				
	400,000	132,000	109,000	140,000	76,90	32338		29	NTN				
	44,000			4,61	4T-JM738249		29	NTN					
190,500	266,700	187,325			33,60	T-67885D/67820/67820D		32	NTN				
	266,700	187,325			33,60	T-E-67885D/67820/67820D		32	NTN				
	282,575	47,625	36,512	50,800	9,39	87750/87111		29	NTN				
	282,575	47,625	36,512	50,800	10,60	T-87750/87111		29	NTN				
	282,575	107,950			20,60	T-87750/87112D+A		30	NTN				
	317,500	63,500	46,038	63,500	17,90	T-93750/93125		29	NTN				
	317,500	146,050			41,20	T-93750/93127D+A		30	NTN				
	336,550	95,250	73,025	98,425	36,40	T-HH840249/HH840210		29	NTN				
	365,049	88,897	63,500	92,075	42,90	T-EE420751/421437		29	NTN				
	365,049	152,400			72,80	T-EE420750D/421437+A		31	NTN				
	368,300	193,675			84,10	T-EE420751/421451D+A		30	NTN				
	368,300	193,675			84,10	E-EE420751/421451D+A		30	NTN				
	428,625	95,250	61,912	106,362	75,30	EE350750/351687		29	NTN				
	193,675	282,575	47,625	36,512	50,800	9,00	87762/87111		29	NTN			
282,575		47,625	36,512	50,800	10,30	T-87762/87111		29	NTN				
282,575		107,950			20,00	T-87762/87112D+A		30	NTN				
195,000	305,000	120,000			32,50	CRD-3906		31	NTN				
196,850	241,300	23,017	17,462	23,812	2,11	CR-3913		29	NTN				
	241,300	23,017	17,462	23,812	2,14	CR-3914		29	NTN				
	241,300	23,017	17,462	23,812	2,04	4T-LL639249/LL639210		29	NTN				
	254,000	27,783	21,433	28,575	5,95	4T-L540049/L540010		29	NTN				
	257,175	39,688	30,162	39,688	5,33	LM739749/LM739710		29	NTN				
	257,175	39,688	30,162	39,688	5,33	4T-LM739749/LM739710		29	NTN				
	317,500	63,500	46,038	63,500	18,70	93775/93125		29	NTN				
	39,688			3,59	4T-LM739749		29	NTN					
198,438	284,162	225,425			46,00	M240648D/M240611/M240611D		32	NTN				
200,000	280,000	51,000	39,000	51,000	9,57	32940		29	SNR				
	280,000	51,000	39,000	51,000	9,14	32940X		29	NTN				
	282,000	206,000			39,00	CRO-4022LL		32	NTN				
	282,000	206,000			40,50	625940		32	NTN				
	282,000	206,000			40,50	E-625940		32	NTN				
	290,000	160,000			35,10	CRO-4013		32	NTN				
	290,000	160,000			35,10	E-CRO-4013		32	NTN				
300,000	62,000	51,000	65,000	15,67	4T-JHM840449/JHM840410		29	NTN					

								Brands	
d	D	B	C	T	Kg	Reference			
200,000	310,000	70,000	53,000	70,000	19,10	32040 A	29	SNR	
	310,000	70,000	53,000	70,000	17,30	32040X	29	NTN	
	310,000	82,000			21,70	323040	31	NTN	
	310,000	82,000			21,70	323040	31	NTN	
	310,000	82,000			20,70	413040	30	NTN	
	310,000	103,000			24,60	423040	30	NTN	
	310,000	103,000			25,70	423040	30	NTN	
	310,000	151,000			38,20	CRI-4020	30	NTN	
	310,000	170,000			42,40	CRI-4027	30	NTN	
	310,000	200,000			54,00	CRO-4014	32	NTN	
	310,000	200,000			48,40	E-CRO-4014	32	NTN	
	320,000	146,000			40,10	CRI-4036	30	NTN	
	330,000	180,000			55,50	CRI-4030	30	NTN	
	330,000	180,000			55,50	CRI-4030	30	NTN	
	340,000	112,000			41,70	323140	31	NTN	
	340,000	112,000			38,60	413140	30	NTN	
	340,000	140,000			52,10	CRD-4019	31	NTN	
	340,000	140,000			47,50	423140	30	NTN	
	340,000	150,000			55,30	CRD-4015	31	NTN	
	340,000	184,000			67,00	CRI-4019	30	NTN	
	360,000	58,000	48,000	64,000	25,40	30240	29	NTN	
	360,000	98,000	82,000	104,000	43,60	32240	29	NTN	
	360,000	142,000			55,60	430240	30	NTN	
	360,000	142,000			62,80	430240U	30	NTN	
	360,000	218,000			90,70	432240	30	NTN	
	360,000	218,000			95,20	432240U	30	NTN	
	420,000	80,000	67,000	89,000	51,00	30340	29	NTN	
	420,000	138,000	115,000	146,000	86,00	32340	29	NTN	
	420,000	235,000			158,00	CRD-4020	31	NTN	
	420,000	292,000			187,50	32340DF	30	NTN	
		62,000			10,30	4T-JHM840449	29	NTN	
	200,025	292,100	57,945	46,038	57,945	11,50	T-M241543/M241510	29	NTN
		292,100	125,415			24,80	T-M241543/M241510D+A	30	NTN
		317,500	63,500	46,038	63,500	18,30	T-93787/93125	29	NTN
		317,500	146,050			38,80	T-93787/93727D+A	30	NTN
		319,960	63,500	46,038	63,500	18,80	93787/J93129A	29	NTN
		384,175	112,712	90,488	112,712	53,00	T-H247535/H247510	29	NTN
		384,175	238,125			132,60	E-H247535/H247510D+A	30	NTN
		384,175	238,125			112,00	T-H247535/H247510D+A	30	NTN
		393,700	111,125	84,138	111,125	55,90	HH144642/HH144614	29	NTN
		112,712			36,10	E-H247535	29	NTN	
202,405	358,826	200,100			79,82	E-H244848TD/H244810A	31	NTN	
	358,775	200,025			85,00	H244848TD/H244810A+A	31	NTN	
203,200	276,225	42,862	34,133	42,862	6,56	LM241149/LM241110	29	NTN	
	276,225	90,485			13,80	LM241149/LM241110D+A	30	NTN	
	282,575	46,038	36,512	46,038	7,76	T-67983/67920	29	NTN	
	282,575	46,038			8,55	67983/67920	29	NTN	
	282,575	101,600			17,10	T-67983/67920D+A	30	NTN	
	292,100	57,945	46,038	57,945	11,20	T-M241547/M241510	29	NTN	
	292,100	125,415			24,10	T-M241547/M241510D+A	30	NTN	
	317,500	63,500	46,038	63,500	16,50	T-93800/93125	29	NTN	
	317,500	120,650			31,00	E-NA132083/132126D	30	NTN	
	317,500	123,825			36,30	T-93800D/93125+A	31	NTN	
	317,500	146,050			38,27	NA93800/93127D	30	NTN	
	317,500	146,050			37,10	T-93800/93127D+A	30	NTN	
	317,500	215,900			62,50	EE132082D/132125/132126D	32	NTN	
	317,500	215,900			62,50	E-EE132082D/132125/132126D	32	NTN	
	346,075	80,962	60,325	79,375	28,80	T-HM542948/HM542911	29	NTN	
	365,049	88,897	63,500	92,075	40,70	T-EE420801/421437	29	NTN	

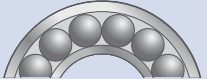

							 Brands	
d	D	B	C	T	Kg	Reference		
203,200	365,049	152,400			69,00	T-EE420800D/421437+A	31	NTN
	368,300	193,675			79,20	E-EE420801/421451CD+A	30	NTN
	368,300	193,675			79,90	T-EE420801/421451D+A	30	NTN
	406,400	85,725	57,150	92,075	54,80	EE114080/114160	29	NTN
	406,400	196,850			107,00	EE114080/114161D+A	30	NTN
	419,100	92,075			66,10	CRT4107	37	NTN
	419,100	92,075			54,40	E-CRT4112	37	NTN
	482,600	95,250	73,025	117,475	108,00	T-EE380080/380190G2	29	NTN
		27,783			2,41	4T-LL641149	29	NTN
		46,038			3,50	4T-67983	29	NTN
	88,897			24,90	E-EE420801	29	NTN	
204,788	292,100	57,945	46,038	57,945	11,00	T-M241549/M241510	29	NTN
	292,100	125,415			23,80	T-M241549/M241510D+A	30	NTN
206,000	283,000	102,000			16,90	CRI-4107	30	NTN
206,375	282,575	46,038	36,512	46,038	10,37	4T-67985/67920	29	NTN
	282,575	46,038	36,512	46,038	8,40	T-67985/67920	29	NTN
	282,575	101,600			16,50	4T-67985/67920D+A	30	NTN
	282,575	101,600			16,50	T-67985/67920D+A	30	NTN
	282,575	190,500			35,40	T-67986D/67920/67920D	32	NTN
	336,550	100,012	77,788	98,425	32,10	T-H242649/H242610	29	NTN
	336,550	184,150			64,10	T-H242649D/H242610+A	31	NTN
	336,550	211,138			70,60	E-H242649/H242610CD	30	NTN
	336,550	211,138			65,20	T-H242649/H242610D+A	30	NTN
	482,600	95,250	73,025	117,475	107,00	T-EE380081/380190G2	29	NTN
	100,012			23,00	4T-H242649	29	NTN	
209,550	282,575	46,038	36,512	46,038	7,23	T-67989/67920	29	NTN
	282,575	101,600			16,00	T-67989/67920D+A	30	NTN
	317,500	63,500	46,038	63,500	15,80	T-93825/93125	29	NTN
	317,500	146,050			36,30	T-93825/93127D+A	30	NTN
210,000	355,000	116,000			44,00	CRI-4202	30	NTN
	480,000	230,000			212,00	CRD-4209	31	NTN
212,725	285,750	46,038	34,925	46,038	7,33	T-LM742745/LM742710	29	NTN
	285,750	98,425			15,70	T-LM742745/LM742710D+A	30	NTN
215,900	285,750	46,038	34,925	46,038	7,45	LM742749/LM742710A	29	NTN
	285,750	46,038	34,925	46,038	7,05	T-LM742749/LM742710	29	NTN
	285,750	85,725			14,80	T-LM742749D/LM742710+A	31	NTN
	285,750	98,425			15,10	T-LM742749/LM742710D+A	30	NTN
	287,338	69,850			11,00	543085/543115D+A	30	NTN
	288,925	177,800			34,30	E-LM742749D/LM742714/LM742714D	32	NTN
	288,925	177,800			34,30	T-LM742749D/LM742714/LM742714D	32	NTN
	290,010	31,750	22,225	31,750	5,20	543085/543114	29	NTN
	46,038			5,23	4T-LM742749E1	29	NTN	
216,103	330,200	263,525			78,20	CRO-4303LL	32	NTN
	330,200	263,525			82,10	9974D/9920/9920D	30	NTN
216,408	285,750	49,212	34,925	46,038	7,40	T-LM742747/LM742710	29	NTN
219,075	358,775	200,025			85,90	E-H244848TD/H244810A+A	31	NTN
	358,775	200,025			79,50	H244849D/H244810A+A	31	NTN
219,969	290,010	31,750	25,000	31,750	5,46	CR-4411	29	NTN
219,974		112,712			38,00	4T-H247540	29	NTN







								Brands
d	D	B	C	T	Kg	Reference		
220,000	295,000	315,000			57,50	CRO-4424LL	32	NTN
	300,000	51,000	39,000	51,000	10,20	32944X	29	NTN
	300,000	96,000			19,00	CRTD4406	38	NTN
	300,000	110,000			21,10	CRI-4410	30	NTN
	300,000	230,000			42,10	CRO-4412	32	NTN
	310,000	226,000			53,50	625944	32	NTN
	310,000	226,000			53,50	E-625944	32	NTN
	310,000	280,000			63,50	CRO-4427LL	32	NTN
	320,000	76,200			20,30	CRD-4405	31	NTN
	320,000	200,000			53,00	CRO-4411	32	NTN
	320,000	290,000			77,00	CRO-4436LL	32	NTN
	340,000	76,000	57,000	76,000	25,00	32044X	29	NTN
	340,000	90,000			29,80	323044	31	NTN
	340,000	90,000			26,70	413044	30	NTN
	340,000	90,000			26,70	413044	30	NTN
	340,000	113,000			32,70	423044	30	NTN
	340,000	113,000			33,30	423044	30	NTN
	340,000	152,000			52,00	4T-32044XDF	30	NTN
	340,000	152,000			52,00	32044XUDF	30	NTN
	340,000	158,000			46,70	CRI-4409	30	NTN
	340,000	164,000			48,50	CRI-4411	30	NTN
	340,000	190,000			63,20	623044	32	NTN
	340,000	194,000			64,50	CRO-4409	32	NTN
	370,000	90,000			31,00	CRT4405	37	NTN
	370,000	120,000			51,20	323144	31	NTN
	370,000	120,000			47,10	413144	30	NTN
	370,000	150,000			59,60	423144	30	NTN
	370,000	150,000			59,00	CRI-4416	30	NTN
	400,000	65,000	54,000	72,000	34,40	30244	29	NTN
	400,000	108,000	90,000	114,000	59,20	32244	29	NTN
	400,000	144,000			70,00	30244DF	30	NTN
	400,000	158,000			76,30	430244	30	NTN
	400,000	210,000			107,00	E-CR1-4417	30	NTN
	400,000	228,000			124,30	32244DF	30	NTN
	400,000	254,000			138,00	CRD-4418	31	NTN
	420,000	130,000			73,10	CRI-4407	30	NTN
	460,000	88,000	73,000	97,000	66,70	30344	29	NTN
	460,000	145,000	122,000	154,000	112,80	32344	29	NTN
	550,000	220,000			305,00	E-CR1-4414LL	30	NTN
	220,662	314,325	61,912	49,212	61,912	14,70	4T-M244249/M244210	29
314,325		61,912	49,212	61,912	13,60	T-M244249/M244210	29	NTN
314,325		115,888			28,60	T-M244249D/M244210+A	31	NTN
314,325		131,762			28,90	T-M244249/M244210D+A	30	NTN
314,325		239,712			60,20	T-E-M244249D/M244210/M244210D	32	NTN
314,325		239,712			60,20	T-M244249D/M244210/M244210D	32	NTN
		61,912			9,83	4T-M244249	29	NTN
228,397	431,800	85,725	49,212	92,075	59,40	EE113089/113170	29	NTN
228,460	431,800	85,725	49,212	92,075	59,40	EE113091/113170	29	NTN
	431,800	196,850			116,00	EE113091/113171D+A	30	NTN
228,600	300,038	31,750	23,812	33,338	5,61	544090/544118	29	NTN
	300,038	31,750	23,812	33,338	6,05	T-544090/544118	29	NTN
	300,038	66,676			11,10	544090/544118DF	30	NTN
	327,025	52,388	36,512	52,388	9,90	8573/8520	29	NTN
	327,025	52,388	36,512	52,388	12,50	T-8573/8520	29	NTN
	327,025	114,300			27,30	T-8573/8520D+A	30	NTN
	355,600	66,675	47,625	68,262	24,30	T-96900/96140	29	NTN
	355,600	69,850	49,212	69,850	22,70	T-EE130902/131400	29	NTN
	355,600	69,850	50,800	69,850	22,70	HM746646/HM746610	29	NTN







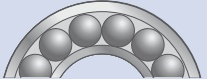







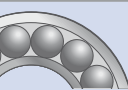

									Brands
d	D	B	C	T	Kg	Reference			
228,600	355,600	152,400			49,40	T-EE130902/131401D+A		30	NTN
	355,600	152,400			49,50	E-E30902/131401D+A		30	NTN
	355,600	152,400			49,40	HM746646/HM746610D+A		30	NTN
	355,600	152,400			49,40	T-96900/96140D+A		30	NTN
	358,775	71,438	53,975	71,438	23,90	T-M249732/M249710		29	NTN
	358,775	152,400			50,90	T-M249732/M249710D+A		30	NTN
	364,000	296,875			117,90	CR0-4606		32	NTN
	400,050	87,312	63,500	88,900	46,00	EE430900/431575		29	NTN
	400,050	139,700			74,20	EE529091D/529157+A		31	NTN
	400,050	187,325			88,30	EE430900/431576D+A		30	NTN
	425,450	177,800			115,00	E-EE700090D/700167+A		31	NTN
	425,450	349,250			232,00	EE700090D/700167/700168D		32	NTN
	425,450	349,250			232,00	E-EE700090D/700167/700168D		32	NTN
	431,800	177,800			131,00	CRD-4604		31	NTN
	482,600	104,775			93,20	CRT4604		37	NTN
	482,600	104,775			101,70	E-CRT4604		37	NTN
	488,950	111,125	73,025	123,825	111,00	T-HH949549/HH949510G2		29	NTN
	488,950	254,000			200,60	E-HH949549/HH949510D+A		30	NTN
	488,950	254,000			207,00	T-HH949549/HH949510DG2+A		30	NTN
	230,000	355,000	146,000			47,00	CRI-4604		30
380,000		175,000			66,97	CRI-4612		30	NTN
380,000		175,000			67,00	CRI-4612		30	NTN
380,000		175,000			73,90	CRI-4613		30	NTN
380,000		175,000			68,60	CRI-4619		30	NTN
380,000		200,000			80,40	CRI-4606		30	NTN
380,000		200,000			84,40	CRI-4606		30	NTN
400,000		188,000			88,50	CRI-4605		30	NTN
230,188	317,500	52,388	36,512	47,625	10,90	4T-LM245846/LM245810		29	NTN
231,775	300,038	31,750	23,812	33,338	5,81	T-544091/544118		29	NTN
	336,550	65,088	50,800	65,088	16,90	T-M246942/M246910		29	NTN
	358,775	71,438	53,975	71,438	23,40	T-M249734/M249710		29	NTN
	358,775	152,400			50,00	T-M249734/M249710D+A		30	NTN
		71,438			16,90	4T-M249734		29	NTN
234,950	311,150	46,038	33,338	46,038	8,38	LM446349/LM446310		29	NTN
	311,150	98,425			17,90	LM446349/LM446310D+A		30	NTN
	314,325	49,212	36,512	49,212	9,38	LM545849/LM545810		29	NTN
	314,325	49,212	36,512	49,212	9,38	T-LM545849/LM545810		29	NTN
	327,025	52,388	36,512	52,388	11,90	T-8575/8520		29	NTN
	327,025	114,300			25,40	8574/8520CD		30	NTN
	327,025	114,300			25,40	8574/8520CD+A		30	NTN
	327,025	114,300			25,90	T-8575/8520D+A		30	NTN
	327,025	196,850			53,60	T-8576D/8520/8520D		32	NTN
	327,025	196,850			53,60	T-E-8576D/8520/8520D		32	NTN
	355,600	66,675	47,625	68,262	22,50	T-96925/96140		29	NTN
	355,600	152,400			47,50	T-96925/96140D+A		30	NTN
	381,000	74,612	57,150	74,612	29,30	T-M252330/M252310		29	NTN
	384,175	112,712	90,488	112,712	52,00	H247549/H247510A		29	NTN
	384,175	112,712	90,488	112,712	45,50	T-H247549/H247510		29	NTN
	384,175	209,550			98,00	H247549D/H247510+A		31	NTN
	384,175	238,125			104,00	E-H247549/H247510CD+A		30	NTN
	384,175	238,125			96,20	T-H247549/H247510D+A		30	NTN
		112,712			33,30	4T-H247549		29	NTN
	235,000	330,000	115,000			27,30	CRI-4701		30
330,000		230,000			55,80	E-CRI-4701		30	NTN
237,330	336,550	65,088	50,800	65,088	16,20	T-M246949/M246910		29	NTN
	358,775	71,438	53,975	71,438	22,60	T-M249736/M249710		29	NTN

								Brands
d	D	B	C	T	Kg	Reference		
237,330	358,775	152,400			48,20	T-M249736/M249710D+A	30	NTN
		65,088			12,00	4T-M246949	29	NTN
240,000	320,000	51,000	39,000	51,000	10,90	32948X	29	NTN
	320,000	110,000			21,60	CRI-4813	30	NTN
	338,000	248,000			67,80	CRO-4811LL	32	NTN
	338,000	248,000			70,00	E-625948A	32	NTN
	338,000	248,000			70,00	625948A (CRO-4825)	32	NTN
	338,000	340,000			94,40	CRO-4817LL	32	NTN
	360,000	40,000	41,000	46,000	14,02	CR-4805	29	NTN
	360,000	76,000	57,000	76,000	26,80	32048 A	29	SNR
	360,000	76,000	57,000	76,000	26,80	32048X	29	NTN
	360,000	92,000			32,60	323048	31	NTN
	360,000	92,000			28,70	413048	30	NTN
	360,000	115,000			35,60	423048	30	NTN
	360,000	115,000			36,30	423048	30	NTN
	360,000	152,000			54,80	4T-32048XDF	30	NTN
	360,000	164,000			53,00	CRI-4806	30	NTN
	360,000	170,000			53,80	CRI-4805	30	NTN
	360,000	194,000			67,10	CRO-4834	32	NTN
	395,000	124,000			60,20	CRD-4804	31	NTN
	400,000	128,000			64,60	323148	31	NTN
	400,000	128,000			58,90	413148	30	NTN
	400,000	160,000			71,70	423148	30	NTN
	400,000	160,000			80,70	CRD-4805	31	NTN
	400,000	160,000			80,70	CRD-4811	31	NTN
	400,000	209,000			96,00	CRI-4807	30	NTN
	440,000	72,000	60,000	79,000	47,70	30248	29	NTN
	440,000	120,000	100,000	127,000	78,80	32248	29	NTN
	440,000	165,000			100,40	430248	30	NTN
	440,000	254,000			163,00	32248DF	30	NTN
	440,000	266,000			164,80	432248	30	NTN
	460,000	140,000			107,00	CRD-4808	31	NTN
	460,000	140,000			107,00	E-CRD-4808	31	NTN
	500,000	95,000	80,000	105,000	87,20	30348	29	NTN
500,000	95,000	80,000	210,000	174,00	30348DF	29	NTN	
500,000	155,000	132,000	165,000	130,02	32348	29	NTN	
241,300	327,025	52,388	36,512	52,388	11,20	T-8578/8520	29	NTN
	327,025	114,300			24,30	T-8578/8520D+A	30	NTN
	349,148	57,150	44,450	57,150	15,90	EE127095/127135	29	NTN
	349,148	127,000			35,40	EE127095/127136D+A	30	NTN
	355,524	109,538			36,80	CRD-4803	31	NTN
	368,300	50,800	33,338	50,800	17,20	EE170950/171450	29	NTN
	368,300	120,650			40,80	EE170950/171450D+A	30	NTN
	393,700	69,850	50,005	73,817	34,30	T-EE275095/275155	29	NTN
	393,700	157,162			66,50	T-EE275095/275156D+A	30	NTN
	406,400	215,900			107,84	E-H249148/H249111DC+A	30	NTN
	406,400	215,900			101,00	T-H249148/H249111D+A	30	NTN
	444,500	100,012	76,200	101,600	68,00	T-EE923095/923175G2	29	NTN
444,500	209,550			128,00	T-EE923095/923176DG2+A	30	NTN	
241,478	349,148	107,950			33,80	EE127097D/127135+A	31	NTN
	350,838	228,600			76,40	EE127097D/127137/127137D	32	NTN
	350,838	228,600			76,40	E-EE127097D/127137/127137D	32	NTN
241,564	358,775	139,700			42,20	E-M249746TD/M249710UP	31	NTN
244,475	327,025	92,075			21,40	LM247748D/LM247710A+A	31	NTN
	327,025	193,675			46,10	E-LM247748D/LM247710/LM247710DA	32	NTN
	327,025	193,675			46,10	LM247748D/LM247710/LM247710DA	32	NTN
	381,000	76,200	57,150	79,375	32,60	EE126097/126150	29	NTN





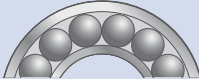



							 Brands	
d	D	B	C	T	Kg	Reference		
244,475	381,000	146,050			61,40	EE126096D/126150+A	31 NTN	
	381,000	171,450			64,00	EE126097/126151D+A	30 NTN	
	381,000	304,800			132,00	EE126096D/126150/126151D	32 NTN	
	381,000	304,800			132,00	E-EE126096D/126150/126151D	32 NTN	
245,000	345,000	310,000			90,50	CRO-4906LL	32 NTN	
	380,000	255,500			106,70	CRO-4901	32 NTN	
247,650	304,800	22,225	15,875	22,225	3,29	4T-28880/28820E1	29 NTN	
	346,075	63,500	50,800	63,500	16,20	T-M348449/M348410	29 NTN	
	346,075	63,700	50,800	63,500	17,70	4T-M348449/M348410	29 NTN	
	368,300	50,800	50,800	50,800	16,50	EE170975/171450	29 NTN	
	368,300	120,650			39,20	EE170975/171451D+A	30 NTN	
	381,000	74,612	57,150	74,612	27,30	T-M252337/M252310	29 NTN	
	406,400	117,475	93,662	117,475	42,80	HH249949/HH249910	29 NTN	
	406,400	219,075			112,00	HH249949D/HH249910+A	31 NTN	
	406,400	247,650			112,00	HH249949/HH249910D+A	30 NTN	
249,250	381,000	76,200	57,150	79,375	31,70	EE126098/126150	29 NTN	
	381,000	171,450			62,20	EE126098/126151D+A	30 NTN	
250,000	310,000	32,000	24,500	32,000	5,11	CR-5009	29 NTN	
	365,000	270,000			82,10	CRO-5004	32 NTN	
	365,000	270,000			82,10	E-CRO-5004	32 NTN	
	365,000	270,000			96,70	CRO-5012	32 NTN	
	365,000	270,000			90,00	CRO-5015LL	32 NTN	
	370,000	220,000			87,00	CRO-5001	32 NTN	
	370,000	220,000			87,00	E-CRO-5001	32 NTN	
	380,000	98,000			35,30	CRI-5004	30 NTN	
380,000	100,000			40,00	E-CRTD5010	37 NTN		
254,000	258,775	269,875			74,40	E-M249749D/M249710/M249710D	32 NTN	
	323,850	22,225	15,875	22,225	3,92	29875/29820	29 NTN	
	323,850	63,500			11,20	29875/29820D+A	30 NTN	
	358,775	71,438	53,975	71,438	21,48	E-M249749/M249710	29 NTN	
	358,775	71,438	53,975	71,438	21,50	M249749/M249710	29 NTN	
	358,775	71,438	53,975	71,438	20,10	T-M249749/M249710	29 NTN	
	358,775	130,175			41,20	T-M249748D/M249710+A	31 NTN	
	358,775	152,400			44,70	M249749/M249710CD+A	30 NTN	
	358,775	152,400			44,70	M249749/M249710D+A	30 NTN	
	358,775	152,400			42,80	T-M249749/M249710D+A	30 NTN	
	358,775	269,875			85,60	T-E-M249748D/M249710/M249710D	32 NTN	
	358,775	269,875			85,60	T-M249748D/M249710/M249710D	32 NTN	
	358,775	269,875			81,70	CRO-5116LL	32 NTN	
	358,775	269,875			83,00	CRO-5117LL	32 NTN	
	365,125	58,738	42,862	58,738	17,70	T-EE134100/134143	29 NTN	
	365,125	130,175			39,20	T-EE134100/134144D+A	30 NTN	
	368,300	92,862			32,50	EE170975D/171450+A	31 NTN	
	368,300	204,622			71,80	EE171000D/171450/171451D	32 NTN	
	368,300	204,622			71,80	E-EE171000D/171450/171451D	32 NTN	
	393,700	69,850	50,005	73,817	32,10	T-EE275100/275155	29 NTN	
	393,700	157,162			62,20	T-EE275100/275156D+A	30 NTN	
	422,275	79,771	66,675	86,121	47,10	T-HM252343/HM252310	29 NTN	
	422,275	178,592			88,90	T-HM252343/HM252310D+A	30 NTN	
	444,500	279,400			185,00	EE822101D/822175/822176D	32 NTN	
	444,500	279,400			185,00	E-EE822101D/822175/822176D	32 NTN	
	533,400	120,650	77,788	133,350	141,00	HH953749/HH953710	29 NTN	
	533,400	276,225			266,00	HH953749/HH953710D+A	30 NTN	
	539,750	117,475			140,00	E-CRT5103	37 NTN	
	585,000	260,000			392,00	CRD-5102	31 NTN	
	257,175	342,900	57,150	44,450	57,150	12,90	M349549/M349510	29 NTN

							 Brands		
d	D	B	C	T	Kg	Reference			
257,175	342,900	57,150	44,450	57,150	12,90	M349549A/M349510	29	NTN	
258,500	365,000	361,000			116,00	E-CRD-5232	31	NTN	
	365,000	361,000			116,00	E-CRD-5232LD2	31	NTN	
259,027	457,200	244,475			165,43	HH255149TD/HH255110+A	31	NTN	
259,500	481,000	250,000			202,00	CRD-5215	31	NTN	
	481,000	250,000			180,00	CRD-5222	31	NTN	
260,000	360,000	40,000	34,000	45,000	11,40	CR-5201	29	NTN	
	360,000	63,500	48,000	63,500	18,60	32952X	29	NTN	
	360,000	272,000			74,20	CRO-5218	32	NTN	
	365,000	339,000			103,00	CRO-5224LL	32	NTN	
	368,000	268,000			90,30	625952	32	NTN	
	368,000	268,000			90,30	625952	32	NTN	
	368,000	268,000			90,30	E-625952	32	NTN	
	389,500	105,000			41,90	CRD-5226	31	NTN	
	400,000	87,000	65,000	87,000	39,40	32052X	29	NTN	
	400,000	104,000			47,30	323052	31	NTN	
	400,000	104,000			41,50	413052	30	NTN	
	400,000	130,000			52,30	423052	30	NTN	
	400,000	150,000			74,60	CRD-5212	31	NTN	
	400,000	174,000			81,25	32052XUDF	30	NTN	
	400,000	185,000			79,00	CRI-5218	30	NTN	
	400,000	220,000			98,90	623052	32	NTN	
	400,000	255,000			106,00	CRO-5215	32	NTN	
	400,000	255,000			106,00	E-CRO-5215	32	NTN	
	440,000	144,000			90,00	323152	31	NTN	
	440,000	144,000			80,00	413152	30	NTN	
	440,000	172,000			98,90	CRI-5224	30	NTN	
	440,000	172,000			99,00	CRI-5224	30	NTN	
	440,000	180,000			99,80	423152	30	NTN	
	445,000	180,000			111,00	CRD-5228	31	NTN	
	458,000	155,000			109,00	CRD-5214	31	NTN	
	459,000	155,000			110,00	CRD-5216	31	NTN	
	459,000	155,000			110,00	CRD-5224	31	NTN	
	480,000	80,000	67,000	89,000	63,40	30252	29	NTN	
	480,000	130,000	106,000	137,000	103,00	32252	29	NTN	
	530,000	275,000			248,00	CRI-5215	30	NTN	
	260,350	365,125	58,738	42,862	58,738	16,80	T-EE134102/134143	29	NTN
		365,125	130,175			37,30	T-EE134102/134144D+A	30	NTN
365,125		228,600			76,50	EE134102D/134143/134144D	32	NTN	
365,125		228,600			76,50	E-EE134102D/134143/134144D	32	NTN	
400,050		67,470	46,038	69,850	27,00	EE221026/221575	29	NTN	
400,050		114,300			52,00	EE221025D/221575+A	31	NTN	
400,050		155,575			62,70	EE221026/221576D+A	30	NTN	
400,050		255,588			117,00	EE221027D/221575/221576D	32	NTN	
400,050		255,588			117,00	E-EE221027D/221575/221576D	32	NTN	
419,100		84,138	61,912	85,725	44,40	EE435102/435165	29	NTN	
419,100		180,000			95,70	CRD-5217	31	NTN	
419,100		184,150			86,80	EE435102/435165D+A	30	NTN	
422,275		79,771	66,675	86,121	45,70	T-HM252348/HM252310	29	NTN	
422,275		136,525	123,825	314,325	180,00	HM252349D/HM252310/HM252310D	32	NTN	
422,275		178,592			86,30	T-HM252348/HM252310D+A	30	NTN	
422,275		314,325			180,00	E-HM252349D/HM252310/HM252310D	32	NTN	
422,275		314,325			177,00	CRO-5227LL	32	NTN	
488,950		120,650	92,075	120,650	90,30	EE295102/295193	29	NTN	
488,950		254,000			190,00	EE295102/295192D+A	30	NTN	
263,525		325,438	28,575	25,400	28,575	4,56	T-38880/38820	29	NTN





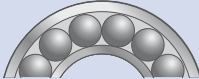

							 Brands
d	D	B	C	T	Kg	Reference	
263,525	355,600	57,150	44,450	57,150	15,77	LM451345/LM451310A	29 NTN
	355,600	57,150	44,450	57,150	14,20	T-LM451345/LM451310	29 NTN
	355,600	127,000			31,70	T-LM451345/LM451310D+A	30 NTN
266,700	323,850	22,225	15,875	22,225	3,52	29880/29820	29 NTN
	323,850	63,500			9,37	29880/29820D+A	30 NTN
	325,438	28,575	25,400	28,575	4,35	T-38885/38820	29 NTN
	355,600	57,150	44,450	57,150	14,90	4T-LM451349/LM451310	29 NTN
	355,600	57,150	44,450	57,150	14,96	LM451349/LM451310A	29 NTN
	355,600	57,150	44,450	57,150	15,00	T-LM451349/LM451310	29 NTN
	355,600	57,150	44,450	57,150	13,80	T-LM451349A/LM451310	29 NTN
	355,600	109,538			29,90	T-LM451349D/LM451310+A	31 NTN
	355,600	127,000			30,70	T-LM451349/LM451310D+A	30 NTN
	355,600	230,188			61,53	E-LM451349D/LM451310/LM451310D	32 NTN
	355,600	230,188			62,00	T-E-LM451349D/LM451310/LM451310D	32 NTN
	355,600	230,188			62,00	T-LM451349D/LM451310/LM451310D (CRO-5307)	32 NTN
	355,600	230,188			62,30	CRO-5305	32 NTN
	393,700	69,850	50,005	73,817	29,70	T-EE275105/275155	29 NTN
	393,700	157,162			57,60	T-EE275105/275156D+A	30 NTN
	393,700	269,878			116,00	EE275106D/275155/275156D	32 NTN
	393,700	269,878			116,00	E-EE275106D/275155/275156D	32 NTN
444,500	117,475	88,900	120,650	73,30	H852849/H852810	29 NTN	
269,875	381,000	74,612	57,150	74,612	25,40	T-M252349/M252310	29 NTN
	381,000	136,525			48,60	T-M252349D/M252310+A	31 NTN
	381,000	158,750			52,30	M252349/M252310D+A	30 NTN
	381,000	158,750			52,30	T-M252349/M252310D+A	30 NTN
	381,000	282,575			97,50	E-M252349D/M252310/M252310D	32 NTN
	381,000	282,575			97,50	T-M252349D/M252310/M252310D	32 NTN
		74,612			17,60	4T-M252349	29 NTN
270,000	395,000	94,000			38,50	CRO-5403	31 NTN
	410,000	222,000			91,00	CRO-5403	32 NTN
	410,000	222,000			91,00	E-CRO-5403	32 NTN
273,050	393,700	69,850	50,005	73,817	28,50	T-EE275108/275155	29 NTN
	393,700	157,162			55,30	T-EE275108/275156D+A	30 NTN
275,000	385,000	200,000			62,50	CRO-5501	32 NTN
	385,000	200,000			62,50	E-CRO-5501	32 NTN
276,225	352,425	34,925	23,812	36,512	7,59	E-L853049/L853010	29 NTN
	352,425	34,925	23,812	36,512	8,40	L853049/L853010	29 NTN
	352,425	40,000	29,000	40,000	8,76	CR-5501	29 NTN
	393,700	130,175			50,50	T-EE275109D/275155+A	30 NTN
	406,400	268,290			122,00	EE275109D/275160/275161D	32 NTN
	406,400	268,290			122,00	E-EE275109D/275160/275161D	32 NTN
276,887	406,400	144,462			62,00	E-M255449TD/M255410AUP	31 NTN
279,400	374,650	47,625	34,925	47,625	13,00	L555233/L555210	29 NTN
	374,650	104,775			28,50	L555233/L555210D+A	30 NTN
	381,000	269,875			79,60	CRO-5628	32 NTN
	393,700	127,000			48,10	EE135111D/135155+A	31 NTN
	393,700	269,875			103,00	EE135111D/135155/135156D	32 NTN
	393,700	269,875			96,40	CRO-5652LL	32 NTN
	419,100	292,100			141,00	CRO-5614	32 NTN
	457,200	244,475			158,00	HH255149D/HH255110+A	31 NTN
	469,900	93,662	69,850	95,250	65,30	EE722110/722185	29 NTN
	469,900	200,025			125,00	EE722110/722186D+A	30 NTN
	469,900	346,075			258,00	EE722111D/722185/722186D	32 NTN
	469,900	346,075			258,00	E-EE722111D/722185/722186D	32 NTN

								Brands
d	D	B	C	T	Kg	Reference		
279,400	488,950	120,650	92,075	120,650	84,90	EE295110/295193	29	NTN
	488,950	254,000			179,00	EE295110/295192D+A	30	NTN
	533,400	241,300			272,00	CRD-5613	31	NTN
	603,250	136,525			172,00	CRT5613	37	NTN
	603,250	136,525			205,00	E-CRT5617	37	NTN
279,578	380,898	244,475			83,20	T-E-LM654644D/LM654610/LM654610D	32	NTN
	380,898	244,475			83,20	T-LM654644D/LM654610/LM654610D (CRO-5679)	32	NTN
279,982	380,898	65,088	49,212	65,088	19,00	T-LM654642/LM654610	29	NTN
	380,898	139,700			40,70	T-LM654642/LM654610D+A	30	NTN
280,000	380,000	63,500	48,000	63,500	20,00	32956X	29	NTN
	380,000	92,000			28,90	E-CRD-5621	31	NTN
	380,000	290,000			105,00	CRO-5650 (CRO-5676)	32	NTN
	380,000	290,000			90,00	CRO-5660LL	32	NTN
	395,000	288,000			109,62	625956	32	NTN
	395,000	288,000			111,00	E-625956	32	NTN
	395,000	288,000			111,00	625956 (CRO-5684)	32	NTN
	395,000	290,000			108,00	CRO-5665LL	32	NTN
	395,000	340,000			126,00	CRO-5664LL	32	NTN
	400,000	150,000			53,80	CRI-5615	30	NTN
	406,400	67,673	53,975	69,850	29,10	EE128112/128160	29	NTN
	410,000	110,000			49,00	CRD-5616	31	NTN
	410,000	110,000			45,20	E-CRD-5616	31	NTN
	410,000	268,000			116,00	CRO-5639LL	32	NTN
	420,000	87,000	65,000	87,000	60,00	32056 A	29	SNR
	420,000	87,000	65,000	87,000	40,40	32056X	29	NTN
	420,000	106,000			51,20	323056	31	NTN
	420,000	106,000			47,20	413056	30	NTN
	420,000	133,000			57,30	423056	30	NTN
	420,000	174,000			86,80	32056XUDF	30	NTN
	460,000	146,000			95,80	323156	31	NTN
	460,000	146,000			87,40	413156	30	NTN
	460,000	183,000			109,00	423156	30	NTN
	500,000	80,000	67,000	89,000	66,60	30256	29	NTN
	500,000	130,000	106,000	137,000	110,00	32256	29	NTN
	580,000	175,000	145,000	187,000	222,00	32356	29	NTN
	280,192	406,400	67,673	53,975	69,850	29,10	EE128111/128160	29
406,400		149,225			56,50	EE128111/128160D+A	30	NTN
281,252	495,300	263,525			225,00	E-HH258249TD/HH258210+A	31	NTN
285,000	380,000	92,000			29,00	CRD-5704	31	NTN
	400,000	340,000			134,00	CRO-5709LL	32	NTN
285,750	358,775	31,750	22,225	33,338	7,54	545112/545141A	29	NTN
	358,775	76,200			15,17	545112/545142D+A	30	NTN
	380,898	65,088	49,212	65,088	18,00	T-LM654649/LM654610	29	NTN
	380,898	117,475			36,70	T-LM654648D/LM654610+A	31	NTN
	380,898	139,700			38,80	E-LM654649/LM654610CD+A	30	NTN
	380,898	139,700			38,70	T-LM654649/LM654610D+A	30	NTN
	380,898	162,176			41,90	E-LM654649/LM654610DB	30	NTN
	380,898	162,176			41,90	LM654649/LM654610DB	30	NTN
	380,898	244,475			82,50	T-E-LM654648D/LM654610/LM654610D	32	NTN
	380,898	244,475			82,50	T-LM654648D/LM654610/LM654610D (CRO-5710)	32	NTN
	501,650	203,200			151,00	EE147112/147198D+A	30	NTN
288,925	406,400	77,788	60,325	77,788	27,80	M255449/M255410A	29	NTN
	406,400	77,788	60,325	77,788	30,20	4T-CR-5812	29	NTN
	406,400	144,462			59,00	E-M255449D/M255410A+A	31	NTN





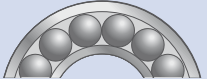



							 Brands	
d	D	B	C	T	Kg	Reference		
288,925	406,400	144,462			58,10	M255449D/M255410A+A	31	NTN
	406,400	165,100			59,00	M255449/M255410DA+A	30	NTN
	406,400	298,450			125,00	E-M255449D/M255410/M255410DA	32	NTN
	406,400	298,450			125,00	M255449D/M255410/M255410DA	32	NTN
290,000	400,000	120,000			40,00	CRI-5808	30	NTN
	400,000	346,000			129,00	CRO-5814LL	32	NTN
	430,000	150,000			72,10	CR1-5810	30	NTN
	430,000	150,000			72,70	CR1-5810	30	NTN
291,150	520,000	266,000			239,00	E-CRTD5807	37	NTN
	374,650	47,625	34,925	47,625	11,90	E-L555249/L555210	29	NTN
	374,650	47,625	34,925	47,625	11,50	L555249/L555210	29	NTN
	374,650	104,775			25,20	L555249/L555210D+A	30	NTN
	469,900	93,662	69,850	95,250	62,00	EE722115/722185	29	NTN
	469,900	200,025			118,00	EE722115/722186D+A	30	NTN
	476,250	296,047			208,00	EE921150D/921875/921876D	32	NTN
	476,250	296,047			208,00	E-EE921150D/921875/921876D	32	NTN
298,450	558,800	136,525	98,425	136,525	135,00	EE790114/790221	29	NTN
	444,500	61,912	39,688	63,500	33,10	EE291175/291750	29	NTN
299,974	444,500	146,050			69,30	EE291175/291751D+A	30	NTN
	495,300	141,288	114,300	141,288	96,00	HH258248/HH258210G2	29	NTN
300,000	495,300	301,625			205,00	HH258248/HH258210DG2+A	30	NTN
	380,000	38,000	28,000	38,000	9,44	CR-6016	29	NTN
300,000	400,000	254,000			84,60	CRO-6038LL	32	NTN
	420,000	76,000	57,000	76,000	31,40	32960X	29	NTN
	420,000	310,000			128,00	CRO-6042LL	32	NTN
	420,000	420,000			163,00	CR-6027DB	30	NTN
	424,000	310,000			138,00	625960	32	NTN
	424,000	310,000			138,00	E-625960	32	NTN
	430,000	280,000			132,00	CRO-6019	32	NTN
	430,000	295,000			136,00	CRO-6031LL	32	NTN
	430,000	300,000			141,00	CRO-6022	32	NTN
	440,000	105,000			54,00	CRD-6025	31	NTN
	440,000	105,000			54,00	CRD-6027	31	NTN
	460,000	100,000	74,000	100,000	63,00	32060X	29	NTN
	460,000	100,000	76,000	100,000	58,20	4T-CR-6013	29	NTN
	460,000	118,000			70,70	323060	31	NTN
	460,000	118,000			64,40	413060	30	NTN
	460,000	148,000			76,70	423060	30	NTN
	460,000	360,000			180,00	CRO-6015	32	NTN
	460,000	360,000			180,00	E-CRO-6015	32	NTN
	470,000	270,000			152,00	CRO-6012	32	NTN
	470,000	270,000			152,00	E-CRO-6012	32	NTN
	470,000	292,000			164,00	E-CRO-6013	32	NTN
	470,000	292,000			164,00	CRO-6013 (CRO-6033)	32	NTN
	495,350	141,288	114,300	141,288	96,00	E-HH258248/HH258210	29	NTN
	500,000	160,000			126,00	323160	31	NTN
	500,000	160,000			112,30	413160	30	NTN
	500,000	180,000			143,00	CRD-6006	31	NTN
	500,000	200,000			144,00	423160	30	NTN
	500,000	200,000			158,00	CRD-6028	31	NTN
	500,000	200,000			158,00	E-CRD-6028	31	NTN
	500,000	200,000			158,00	CRD-6030	31	NTN
	500,000	332,000			257,00	623160	32	NTN
	500,000	332,000			257,00	623160A	32	NTN
	520,000	180,000			187,00	CRD-6026	31	NTN
	540,000	85,000	71,000	96,000	83,10	30260	29	NTN
	540,000	140,000	115,000	149,000	130,00	32260	29	NTN

								Brands
d	D	B	C	T	Kg	Reference		
300,000	540,000	208,000			184,00	CRI-6010	30	NTN
	540,000	298,000			289,00	32260DF	30	NTN
300,038	422,275	82,550	63,500	82,550	31,90	T-HM256849/HM256810G2	29	NTN
	422,275	150,812			65,60	T-HM256849D/HM256810G2+A	31	NTN
	422,275	174,625			69,20	E-HM256849/HM256810D+A	30	NTN
	422,275	174,625			67,40	T-HM256849/HM256810DG2+A	30	NTN
	422,275	311,150			143,00	T-E-HM256849D/HM256810/HM256810DG2	32	NTN
	422,275	311,150			143,00	T-HM256849D/HM256810/HM256810DG2	32	NTN
304,271	447,675	158,750			84,26	E-CRD-6111K	31	NTN
304,648	438,048	128,575			62,80	CRD-6132	31	NTN
	438,048	131,762			64,30	EE329119D/329172+A	31	NTN
	438,048	279,400			143,00	EE329119D/329172/329173D	32	NTN
	438,048	279,400			143,00	E-EE329119D/329172/329173D	32	NTN
	438,048	280,990			136,00	CRO-6143LL	32	NTN
	438,048	280,990			140,00	E-M757448D/M757410/M757410D	32	NTN
	438,048	280,990			140,00	M757448D/M757410/M757410D	32	NTN
304,800	393,700	50,800	38,100	50,800	13,80	L357049/L357010	29	NTN
	393,700	107,950			29,30	L357049/L357010D+A	30	NTN
	406,400	63,500	47,625	63,500	20,10	T-LM757049/LM757010	29	NTN
	419,100	130,175			53,10	M257149D/M257110+A	31	NTN
	419,100	269,875			115,00	E-M257149D/M257110/M257110D	32	NTN
	419,100	269,875			115,00	M257149D/M257110/M257110D	32	NTN
	438,048	76,992	53,975	76,200	34,80	T-EE129120X/129172	29	NTN
	438,048	165,100			71,40	T-EE129120X/129120D+A	30	NTN
	444,500	61,912	39,688	63,500	31,90	EE291201/291750	29	NTN
	444,500	107,950			55,70	EE291200D/291750+A	30	NTN
	444,500	146,050			66,80	EE291201/291751D+A	30	NTN
	444,500	247,650			127,00	EE291202D/291750/291751D	32	NTN
	444,500	247,650			127,00	E-EE291202D/291750/291751D	32	NTN
	495,300	74,612	53,975	76,200	55,80	EE941205/941950A	29	NTN
	495,300	92,075	69,850	95,250	69,70	EE724120/724195	29	NTN
	495,300	92,075	69,850	95,250	69,80	E-EE724120/724195	29	NTN
	495,300	196,850			131,00	EE724120/724196D+A	30	NTN
	495,300	342,900			273,00	EE724121D/724195/724196D	32	NTN
	495,300	342,900			273,00	E-EE724121D/724195/724196D	32	NTN
	499,948	79,375	53,975	101,600	67,00	E-M959442/M959410	29	NTN
	499,948	158,750			158,00	CRD-6109	31	NTN
	499,948	200,000			155,00	CRD-6123	31	NTN
558,800	136,525	98,425	136,525	131,00	EE790120/790221	29	NTN	
304,902	412,648	128,588			49,00	M257248D/M257210+A	31	NTN
	412,648	266,700			107,00	E-M257248D/M257210/M257210D	32	NTN
	412,648	266,700			107,00	M257248D/M257210/M257210D	32	NTN
305,000	438,048	134,145			65,30	M757449D/M757410+A	31	NTN
	500,000	200,000			135,00	CRD-6120	31	NTN
	500,000	200,000			155,00	CRD-6137	31	NTN
	500,000	200,000			155,00	CRD-6148	31	NTN
	500,000	200,000			155,00	E-CRD-6148	31	NTN
	500,000	200,000			155,00	CRD-6151	31	NTN
	500,000	200,000			141,00	E-CRD-6151	31	NTN
	559,968	169,977			193,00	CRD-6140	31	NTN
	560,000	200,000			218,00	CRD-6135	31	NTN
	560,000	200,000			218,00	CRD-6146	31	NTN
	560,000	200,000			218,00	CRD-6154	31	NTN
	560,000	223,000			227,00	CRI-6108	30	NTN
305,003	438,048	280,990			139,00	E-M757449D/M757410/M757410D	32	NTN

							 Brands		
d	D	B	C	T	Kg	Reference			
305,003	438,048	280,990			139,00	M757449D/M757410/M757410D	32	NTN	
	559,867	169,977			192,00	CRD-6113	31	NTN	
305,069	559,999	200,000			218,00	CRD-6112	31	NTN	
	559,999	200,000			218,00	CRD-6152	31	NTN	
	560,000	200,000			218,00	CRD-6136	31	NTN	
305,079	500,000	200,000			155,00	CRD-6101	31	NTN	
	500,000	200,000			155,00	CRD-6116	31	NTN	
	500,000	200,000			155,00	CRD-6125	31	NTN	
305,105	559,867	169,977			217,00	CRD-6104	31	NTN	
	559,867	169,977			217,00	CRD-6117	31	NTN	
	559,968	200,000			217,00	CRD-6110	31	NTN	
	599,968	170,434			169,00	CRD-6115	31	NTN	
310,000	430,000	310,000			136,00	CRO-6204	32	NTN	
	430,000	310,000			133,00	CRO-6213	32	NTN	
	430,000	310,000			133,00	CRO-6220LL	32	NTN	
	430,000	350,000			150,00	CRO-6222LL	32	NTN	
311,150	558,800	190,500			181,00	E-CR1-6216	30	NTN	
317,500	422,275	128,588			49,10	LM258648D/LM258610+A	31	NTN	
	422,275	269,875			110,00	E-LM258649D/LM258610/LM258610D	32	NTN	
	422,275	269,875			110,00	LM258649D/LM258610/LM258610D (CRO-6431)	32	NTN	
	444,500	61,912	39,688	63,500	29,50	EE291250/291750	29	NTN	
	444,500	146,050			61,80	EE291250/291751D+A	30	NTN	
	447,675	85,725	68,262	85,725	40,20	E-HM259048/HM259010	29	NTN	
	447,675	85,725	68,262	85,725	40,20	4T-HM259049/HM259010	29	NTN	
	447,675	85,725	150,812	180,975	83,18	HM259048/HM259010D+A	30	NTN	
	447,675	87,725	68,262	85,725	37,30	T-HM259048/HM259010	29	NTN	
	447,675	158,750	146,050	327,025	161,00	T-HM259049D/HM259010/HM259010D	32	NTN	
	447,675	158,750			78,90	HM259049D/HM259010+A	31	NTN	
	447,675	158,750			77,90	T-HM259049D/HM259010+A	32	NTN	
	447,675	180,975			78,80	T-HM259049/HM259010D+A	30	NTN	
	447,675	327,025			161,00	T-E-HM259049D/HM259010/HM259010D	32	NTN	
	558,800	254,000			248,00	CRI-6412	30	NTN	
	622,300	131,762	82,550	147,638	203,00	H961649/H961610G2	29	NTN	
	622,300	304,800			382,00	H961649/H961610DG2+A	30	NTN	
		61,912			17,00	E-EE291250	29	NTN	
	320,000	440,000	76,000	57,000	76,000	33,10	32964X	29	NTN
		460,000	338,000			183,00	625964	32	NTN
460,000		338,000			183,00	E-625964	32	NTN	
470,000		340,000			141,00	E-CRO-6604	32	NTN	
480,000		100,000	74,000	100,000	33,50	32064 A	29	SNR	
480,000		100,000	74,000	100,000	60,20	32064X	29	NTN	
480,000		100,000	76,000	100,000	58,60	4T-CR-6408	29	NTN	
480,000		121,000			76,30	323064	31	NTN	
480,000		121,000			70,90	413064	30	NTN	
480,000		151,000			85,40	423064	30	NTN	
480,000		200,000			125,00	32064XUDF	30	NTN	
480,000		360,000			228,00	CRO-6426LL	32	NTN	
510,800		220,000			173,00	CRD-6409	31	NTN	
540,000		176,000			164,00	323164	31	NTN	
540,000		176,000			150,00	413164	30	NTN	
540,000		220,000			186,00	423164	30	NTN	
550,000		240,000			223,00	CRI-6410	30	NTN	
580,000		92,000	75,000	104,000	103,90	30264	29	NTN	
580,000		150,000	125,000	159,000	172,10	32264	29	NTN	
580,000		240,000			260,00	CRD-6415	31	NTN	



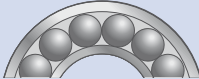



								Brands
d	D	B	C	T	Kg	Reference		
320,000	620,000	280,000			390,00	CRD-6420	31	NTN
327,000	445,000	230,000			99,80	CRO-6501	32	NTN
330,000	458,000	120,000			59,70	CRD-6604	31	NTN
	460,000	52,000	35,000	52,000	24,80	CR-6604	29	NTN
	470,000	340,000			141,00	CRO-6604	32	NTN
	500,000	190,000			117,00	CRI-6603	30	NTN
	510,000	340,000			221,00	CRO-6602	32	NTN
	510,000	340,000			221,00	E-CRO-6602	32	NTN
	650,000	248,000			383,00	CRD-6608	31	NTN
330,200	415,925	47,625	34,925	47,625	13,30	T-L860048/L860010	29	NTN
	415,925	47,625	34,925	47,625	13,30	T-L860049/L860010	29	NTN
	482,600	55,562	38,100	60,325	35,90	T-EE161300/161900	29	NTN
	482,600	80,167	60,325	85,725	47,30	EE526130/526190	29	NTN
	482,600	133,350			72,20	T-EE161300/161901D+A	30	NTN
	482,600	177,800			96,30	EE526130/526191D+A	30	NTN
	482,600	306,388			197,00	EE526131D/526190/526191D	32	NTN
	482,600	306,388			197,00	E-EE526131D/526190/526191D	32	NTN
	533,400	254,000			221,00	CRO-6606	32	NTN
333,375	469,900	90,488	71,438	90,488	43,40	HM261049/HM261010A	29	NTN
	469,900	166,688			90,10	HM261049D/HM261010A+A	31	NTN
	469,900	190,500			91,30	E-HM261049/HM261010DA+A	30	NTN
	469,900	190,500			91,30	HM261049/HM261010DA+A	30	NTN
	469,900	342,900			187,00	HM261049D/HM261010/HM261010DA	32	NTN
	496,900	342,900			186,15	E-HM261049D/HM261010/HM261010D	32	NTN
340,000	440,000	40,000	29,000	40,000	14,60	CR-6816	29	NTN
	460,000	76,000	57,000	76,000	34,90	32968X	29	NTN
	460,000	160,000			70,00	CRI-6808	30	NTN
	470,000	110,000			57,80	CRD-6804	31	NTN
	480,000	350,000			200,00	625968	32	NTN
	480,000	350,000			200,00	E-625968	32	NTN
	500,000	249,000			154,00	CRI-6812	30	NTN
	500,000	249,220			168,00	CR1-6817	30	NTN
	520,000	106,000	90,000	112,000	78,70	32068	29	NTN
	520,000	133,000			101,00	323068	31	NTN
	520,000	133,000			89,20	413068	30	NTN
	520,000	165,000			113,00	423068	30	NTN
	520,000	278,000			213,00	623068	32	NTN
	580,000	190,000			207,00	323168	31	NTN
	580,000	190,000			188,00	413168	30	NTN
	580,000	238,000			228,70	423168	30	NTN
341,312	457,098	254,000			125,00	E-LM761648D/LM761610/LM761610D	32	NTN
	457,098	254,000			125,00	LM761648D/LM761610/LM761610D	32	NTN
342,900	450,850	66,675	52,388	66,675	25,00	LM361649/LM361610	29	NTN
	457,098	63,500	47,625	68,262	30,00	LM961548/LM961511	29	NTN
	457,098	142,875			57,10	LM961548/LM961511D+A	30	NTN
	508,000	82,550	55,562	82,550	49,70	CR-6903	29	NTN
	508,000	469,900			167,00	CR-6902DF	30	NTN
	533,400	76,200	50,800	76,200	55,60	EE971354/972100	29	NTN
	533,400	165,100			83,90	EE971354/972102D	30	NTN
	533,400	165,100			120,00	EE971354/972102D+A	30	NTN
	533,400	307,985			252,00	EE971355D/972100/972103D	32	NTN
	533,400	307,985			252,00	E-EE971355D/972100/972103D	32	NTN
		63,500			19,80	4T-LM961548	29	NTN
343,052	457,098	122,238			55,00	LM761649D/LM761610+A	31	NTN



							 Brands	
d	D	B	C	T	Kg	Reference		
343,052	457,098	254,000			105,00	CRO-6910 (CRO-6944)	32	NTN
	457,098	254,000			107,00	CRO-6920LL	32	NTN
	457,098	254,000			105,00	CRO-6930LL	32	NTN
	457,098	254,000			111,86	E-LM761649D/LM761610/LM761610D	32	NTN
	457,098	254,000			117,00	LM761649D/LM761610/LM761610D (CRO-6945)	32	NTN
	457,098	299,000			130,00	CRO-6936LL	32	NTN
345,000	550,000	270,000			218,00	E-CRD-6908	31	NTN
346,075	482,600	55,562	38,100	60,325	32,80	T-EE161363/161900	29	NTN
	482,600	133,350			66,00	T-EE161363/161901D+A	30	NTN
	488,950	95,250	74,612	95,249	52,50	T-HM262748/HM262710	29	NTN
	488,950	95,250	74,612	95,250	53,80	E-HM262749/HM262710	29	NTN
	488,950	95,250	74,612	95,250	49,70	T-HM262749/HM262710G2	29	NTN
	488,950	174,625			103,00	T-HM262749D/HM262710G2+A	31	NTN
	488,950	200,025			111,00	E-HM262749/HM262710CD+A	30	NTN
	488,950	200,025			104,00	E-HM262749/HM262710D+A	30	NTN
	488,950	200,025			104,00	T-HM262749/HM262710DG2+A	30	NTN
	488,950	358,775			227,00	T-E-HM262749D/HM262710/HM262710DG2	32	NTN
	488,950	358,775			227,00	T-HM262749D/HM262710/HM262710DG2	32	NTN
		95,250			37,10	4T-HM262748	29	NTN
	347,662	469,900	138,112			68,00	M262449D/M262410+A	31
469,900		292,100			148,00	E-M262449D/M262410/M262410D	32	NTN
469,900		292,100			148,00	M262449D/M262410/M262410D	32	NTN
349,250	501,650	84,138	69,850	90,488	56,40	EE333137/333197	29	NTN
	514,350	193,675			121,00	EE333137/333203D+A	30	NTN
		84,138			37,20	E-EE333137	29	NTN
350,000	480,000	110,000			58,70	CRD-7015	31	NTN
	480,000	420,000			207,50	E-CRD-7018LL	31	NTN
	590,000	192,000			218,00	CRD-7011	31	NTN
	590,000	192,000			209,00	CRD-7017	31	NTN
	618,000	200,000			252,00	CRD-7004	31	NTN
352,822	523,875	185,738			136,00	E-HM265049TD/HM265010	31	NTN
355,000	490,000	316,000			170,00	CRO-7105	32	NTN
	490,000	316,000			170,00	E-CRO-7105	32	NTN
	490,000	316,000			159,00	CRO-7109LL	32	NTN
355,600	444,500	60,325	47,625	60,325	18,80	T-L163149/L163110	29	NTN
	444,500	114,300			40,10	T-L163149D/L163110+A	31	NTN
	444,500	136,525			42,50	T-L163149/L163110D+A	30	NTN
	444,500	241,300			89,50	E-L163149D/L163110/L163110D	32	NTN
	444,500	241,300			89,50	L163149D/L163110/L163110D	32	NTN
	457,200	120,650			49,10	LM263149D/LM263110+A	31	NTN
	457,200	252,412			106,00	E-LM263149D/LM263110/LM263110D	32	NTN
	457,200	252,412			106,00	LM263149D/LM263110/LM263110D	32	NTN
	469,900	55,562	38,100	60,325	27,30	T-EE161400/161850	29	NTN
	482,600	55,562	38,100	60,325	30,80	T-EE161400/161900	29	NTN
	482,600	128,588			67,40	LM763449D/LM763410+A	31	NTN
	482,600	133,350			62,10	T-EE161400/161901D+A	30	NTN
	482,600	133,350			62,10	E-E61400/161901DC+A	30	NTN
	482,600	265,112			145,00	E-LM763449D/LM763410/LM763410D	32	NTN
	482,600	265,112			145,00	LM763449D/LM763410/LM763410D (CRO-7123)	32	NTN
	488,950	153,988			85,40	M263349D/M263310+A	31	NTN
	488,950	317,500			173,00	E-M263349D/M263310/M263310D	32	NTN
	488,950	317,500			173,00	M263349D/M263310/M263310D	32	NTN
	501,650	66,675	50,800	74,612	44,90	T-EE231400/231975	29	NTN
	501,650	84,138	69,850	90,488	50,80	EE333140/333197	29	NTN



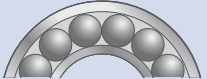



									Brands
d	D	B	C	T	Kg	Reference			
355,600	501,650	111,125			68,50	T-EE231401D/231975+A	31	NTN	
	501,650	155,575			85,20	T-EE231400/231976D+A	30	NTN	
	501,650	155,575			85,20	E-EE231400/231976D+A	30	NTN	
	514,350	193,675			117,00	EE333140/333203D+A	30	NTN	
		84,138			34,90	E-EE333140	29	NTN	
360,000	480,000	76,000	57,000	76,000	36,60	32972X	29	NTN	
	480,000	375,000			180,00	CRO-7226LL	32	NTN	
	480,000	480,000			211,00	CR-7222DB	30	NTN	
	508,000	370,000			236,00	E-625972	32	NTN	
	508,000	370,000			236,00	625972 (CRO-7227)	32	NTN	
	520,000	370,000			260,00	CRO-7220	32	NTN	
	520,000	410,000			297,00	CRO-7217	32	NTN	
	540,000	106,000	90,000	112,000	83,70	32072	29	NTN	
	540,000	134,000			107,00	323072	31	NTN	
	540,000	134,000			98,20	413072	30	NTN	
	540,000	169,000			120,00	423072	30	NTN	
	540,000	200,000			161,00	CRD-7201	31	NTN	
	540,000	340,000			270,00	CRO-7211	32	NTN	
	600,000	192,000			218,00	323172	31	NTN	
	600,000	192,000			199,00	413172	30	NTN	
	600,000	240,000			248,00	423172	30	NTN	
	600,000	396,000			447,00	623172 (CRO-7228)	32	NTN	
	600,000	540,000			520,00	CRO-7210	32	NTN	
	600,000	540,000			520,00	E-CRO-7210	32	NTN	
	680,000	320,000			570,00	CRD-7207	31	NTN	
361,950	406,400	23,812	17,462	23,812	3,56	LL562749/LL562710	29	NTN	
368,249	523,875	101,600	79,375	101,600	65,00	E-HM265049/HM265010	29	NTN	
	523,875	101,600	79,375	101,600	61,70	HM265049/HM265010G2	29	NTN	
	523,875	101,600	169,862	214,312	142,00	HM265049/HM265010DG2+A	30	NTN	
368,300	501,650	250,825			145,00	LM765149D/LM765110/LM765110D	32	NTN	
	523,875	185,738			133,00	E-HM265049D/HM265010+A	31	NTN	
	523,875	185,738			130,00	HM265049D/HM265010G2+A	31	NTN	
	523,875	382,588			280,00	E-HM265049D/HM265010/HM265010DG2	32	NTN	
	523,875	382,588			280,00	HM265049D/HM265010/HM265010DG2 (CRO-7406)	32	NTN	
	596,900	342,900			373,00	EE181455D/182350/182351D	32	NTN	
	609,600	142,875			162,00	EE321145/321240A	32	NTN	
	609,600	279,400			313,00	E-EE321146D/321240A+A	31	NTN	
370,000	630,000	240,000			316,00	CRD-7401	31	NTN	
	680,000	280,000			420,00	CRI-7402	30	NTN	
371,475	501,650	66,675	50,800	74,612	40,70	T-EE231462/231975	29	NTN	
	501,650	66,675	50,800	74,612	40,70	EE231462/231975	29	NTN	
	501,650	155,575			77,30	T-EE231462/231976D+A	30	NTN	
	514,350	155,575			83,30	EE231462/232026D+A	30	NTN	
374,650	501,650	250,825			145,00	E-LM765149D/LM765110/LM765110D	32	NTN	
	522,288	84,138	61,912	85,725	54,50	LM565943/LM565910	29	NTN	
379,000	681,500	307,000			525,00	CRD-7615	31	NTN	
	681,500	307,000			525,00	CRD-7621	31	NTN	
380,000	508,000	139,700			69,50	CRI-7619	30	NTN	
	520,000	82,000	72,000	87,000	50,50	32976	29	NTN	
	536,000	390,000			277,00	625976	32	NTN	
	536,000	390,000			277,00	E-625976	32	NTN	
	550,000	255,000			185,00	E-CRD-7631	31	NTN	
	559,500	160,000			133,00	CRD-7614	31	NTN	



							 Brands	
d	D	B	C	T	Kg	Reference		
380,000	560,000	106,000	90,000	112,000	89,10	32076	29	NTN
	560,000	135,000			113,00	323076	31	NTN
	560,000	135,000			95,90	413076	30	NTN
	560,000	171,000			126,00	423076	30	NTN
	560,000	282,000			240,00	623076	32	NTN
	560,000	285,000			208,00	CRO-7612	32	NTN
	560,000	285,000			208,00	E-CRO-7612	32	NTN
	560,000	360,000			312,00	CRO-7621	32	NTN
	560,000	360,000			302,22	CRO-7622	32	NTN
	620,000	194,000			229,00	323176	31	NTN
	620,000	194,000			206,00	413176	30	NTN
	620,000	241,000			252,00	CRI-7614	30	NTN
	620,000	243,000			262,00	423176	30	NTN
	650,000	240,000			338,20	CRD-7612	31	NTN
	650,000	240,000			329,00	CRD-7623	31	NTN
381,000	479,425	47,625	34,925	49,212	20,00	L865547/L865512	29	NTN
	508,000	58,738	38,100	63,500	34,40	EE192150/192200	29	NTN
	508,000	139,700			69,00	EE192150/192201D+A	30	NTN
	522,288	84,138	61,912	85,725	52,50	LM565949/LM565910	29	NTN
	523,875	84,138	61,912	85,725	53,20	LM565949/LM565912	29	NTN
	546,100	104,775	82,550	104,775	76,00	T-HM266446/HM266410	29	NTN
	546,100	104,775	82,550	104,775	70,10	T-HM266447/HM266410G2	29	NTN
	546,100	222,250			149,00	T-HM266446/HM266410D+A	30	NTN
	590,550	114,300	88,900	114,300	102,00	T-M268730/M268710G2	29	NTN
	590,550	244,475			247,00	T-M268730/M268710DG2+A	30	NTN
384,175	441,325	28,575	20,638	28,575	6,03	E-LL365348/LL365310	29	NTN
	441,325	28,575	20,638	28,575	5,89	LL365348/LL365310	29	NTN
	441,325	68,262			14,10	LL365340/LL365310D+A	30	NTN
	546,100	104,775	82,550	104,775	74,50	E-HM266448/HM266410	29	NTN
	546,100	104,775	82,550	104,775	69,00	T-HM266448/HM266410	29	NTN
	546,100	104,775	82,550	104,775	74,50	HM266449/HM266410	29	NTN
	546,100	104,775	82,550	104,775	69,00	T-HM266449/HM266410G2	29	NTN
	546,100	193,675			153,00	T-HM266449D/HM266410G2+A	31	NTN
	546,100	193,675			152,00	HM266449TD/HM266410	31	NTN
	546,100	222,250			146,00	T-HM266448/HM266410D+A	30	NTN
	546,100	222,250			156,42	HM266449/HM266410DC+A	30	NTN
	546,100	222,250			146,00	T-HM266449/HM266410DG2+A	30	NTN
	546,100	400,050			336,00	E-HM266449D/HM266410/HM266410D	32	NTN
	546,100	400,050			312,00	T-E-HM266449D/HM266410/HM266410DG2	32	NTN
	546,100	400,050			312,00	T-HM266449D/HM266410/HM266410DG2	32	NTN
385,000	530,000	180,000			116,00	CRD-7701	31	NTN
385,762	514,350	82,550	63,500	82,550	45,44	E-LM665949/LM665910	29	NTN
	514,350	82,550	63,500	82,550	41,80	LM665949/LM665910	29	NTN
	514,350	177,800			90,00	E-LM665949/LM665910CD+A	30	NTN
	514,350	177,800			90,00	LM665949/LM665910D+A	30	NTN
	514,350	317,500			240,00	E-LM665949D/LM665910/LM665910D	32	NTN
	514,350	317,500			240,00	LM665949D/LM665910/LM665910D	32	NTN
387,248	546,100	87,312	68,262	87,312	56,60	M667935/M667911G2	29	NTN
390,000	510,000	350,000			186,00	CRO-7801	32	NTN
	600,000	185,000			175,00	CRI-7803	30	NTN
	600,000	185,000			165,00	CR1-7808	30	NTN
393,700	546,100	138,112			97,40	LM767745D/LM767710+A	31	NTN
	546,100	288,925			219,00	E-LM767745D/LM767710/LM767710D	32	NTN
	546,100	288,925			219,00	LM767745D/LM767710/LM767710D	32	NTN
	546,100	469,900			153,00	CR-7901DF	30	NTN



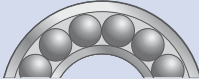



								Brands	
d	D	B	C	T	Kg	Reference			
395,000	545,000	268,700			200,00	CRO-7901	32	NTN	
	545,000	268,700			200,00	E-CRO-7901	32	NTN	
396,875	539,750	142,875			83,60	EE234156/234213D+A	30	NTN	
	546,100	61,120	55,562	76,200	51,50	EE234156/234215	29	NTN	
	546,100	158,750			97,70	EE234156/234216D+A	30	NTN	
	549,275	84,138	61,912	84,138	61,45	LM567943/LM567910B	29	NTN	
398,462	590,550	209,550			207,00	E-M268749TD/M268710+A	31	NTN	
400,000	540,000	82,000	71,000	87,000	54,00	32980	29	NTN	
	540,000	140,000			80,60	CRI-8005	30	NTN	
	560,000	380,000			300,00	CRO-8005	32	NTN	
	560,000	380,000			300,00	E-CRO-8005	32	NTN	
	564,000	412,000			324,00	625980	32	NTN	
	564,000	412,000			324,00	E-625980	32	NTN	
	590,000	142,000			134,00	CRD-8008	31	NTN	
	590,000	142,000			134,00	CRD-8012	31	NTN	
	600,000	118,000	100,000	125,000	115,00	32080	29	NTN	
	600,000	148,000			146,00	323080	31	NTN	
	600,000	148,000			105,00	413080	30	NTN	
	600,000	185,000			163,00	423080	30	NTN	
	635,000	470,000			564,00	CRO-8010	32	NTN	
	650,000	200,000			259,00	323180	31	NTN	
	650,000	200,000			236,00	413180	30	NTN	
	650,000	200,000			260,00	CRD-8010	31	NTN	
	650,000	240,000			303,00	CRD-8013	31	NTN	
	650,000	240,000			303,00	CRD-8014	31	NTN	
	650,000	240,000			303,00	CRD-8023	31	NTN	
	650,000	240,000			303,00	CRD-8026	31	NTN	
	650,000	240,000			292,00	E-CRD-8026	31	NTN	
	650,000	240,000			303,00	CRD-8027	31	NTN	
	650,000	240,000			303,00	CRD-8032	31	NTN	
	650,000	240,000			303,00	CRD-8034	31	NTN	
	650,000	240,000			303,00	CRD-8035	31	NTN	
	650,000	240,000			302,00	CRD-8038	31	NTN	
	650,000	240,000			303,00	CRD-8039	31	NTN	
	650,000	240,000			303,00	CRD-8042	31	NTN	
	650,000	240,000			292,00	CRD-8044	31	NTN	
	650,000	240,000			292,00	E-CRD-8044	31	NTN	
	650,000	240,000			303,00	CRD-8046	31	NTN	
	650,000	240,000			303,00	CRD-8047	31	NTN	
	650,000	240,000			303,00	CRD-8048	31	NTN	
	650,000	240,000			303,00	CRD-8049	31	NTN	
	650,000	250,000			294,00	423180	30	NTN	
	650,000	250,000			325,00	CRD-8017	31	NTN	
	730,000	340,000			672,00	CRD-8029	31	NTN	
	780,000	380,000			895,00	CRD-8040	31	NTN	
	403,225	460,375	28,575	20,638	28,575	6,60	LL566848/LL566810	29	NTN
	406,400	539,750	142,875			78,80	EE234160/234213D+A	30	NTN
		546,100	61,120	55,562	76,200	48,70	EE234160/234215	29	NTN
		546,100	138,112			90,50	LM767749D/LM767710+A	31	NTN
546,100		268,288			190,00	EE234161D/234215/234216D	32	NTN	
546,100		288,925			190,00	E-LM767749D/LM767710/LM767710D	32	NTN	
546,100		288,925			201,00	LM767749D/LM767710/LM767710D	32	NTN	
549,275		84,138	61,912	85,725	56,20	LM567949/LM567910	29	NTN	
565,150		381,000			310,00	CRO-8103	32	NTN	
590,550		107,950	80,962	107,950	86,60	EE833160X/833232	29	NTN	
590,550		193,675			175,00	EE833160XD/833232+A	31	NTN	
590,550		400,050			395,00	EE833161D/833232/833233D	32	NTN	



							 Brands	
d	D	B	C	T	Kg	Reference		
406,400	590,550	400,050			395,00	E-EE833161D/833232/833233D	32	NTN
	609,600	84,138	60,325	92,075	91,30	EE911600/912400	29	NTN
	609,600	187,325			169,00	EE911600/912401D+A	30	NTN
	609,600	309,562			332,00	EE911603D/912400/912401D	32	NTN
	609,600	309,562			332,00	E-EE911603D/912400/912401D	32	NTN
	673,100	192,639			245,00	EE571602/572651D+A	30	NTN
409,575	546,100	87,312	68,262	87,312	49,80	M667948/M667911	29	NTN
	546,100	161,925			104,00	M667947D/M667910G2+A	31	NTN
	546,100	334,962			226,00	E-M667947D/M667911/M667911DG2	32	NTN
	546,100	334,962			226,00	M667947D/M667911/M667911DG2	32	NTN
	546,100	334,962			216,00	E-CRO-8205	32	NTN
410,000	546,000	400,000			253,00	CRO-8204LL	32	NTN
	580,000	160,000			133,00	CRD-8201	31	NTN
415,925	590,550	114,300	88,900	114,300	97,90	E-M268749/M268710	29	NTN
	590,550	114,300	88,900	114,300	87,80	T-M268749/M268710G2	29	NTN
	590,550	209,550			181,00	T-M268749D/M268710G2+A	31	NTN
	590,550	244,475			188,00	T-M268749/M268710DG2+A	30	NTN
	590,550	434,975			421,00	T-E-M268749D/M268710/M268710DG2	32	NTN
	590,550	434,975			421,00	T-M268749D/M268710/M268710DG2	32	NTN
420,000	520,000	90,000			40,90	CRD-8402	31	NTN
	540,000	500,000			253,00	CR-8410DB	30	NTN
	560,000	82,000	71,000	87,000	56,60	32984	29	NTN
	560,000	520,000			309,00	CR-8411DB	30	NTN
	592,000	432,000			374,00	E-625984	32	NTN
	592,000	432,000			374,00	625984 (CRO-8414)	32	NTN
	592,000	432,000			372,00	E-CRO-8414	32	NTN
	620,000	118,000	100,000	125,000	121,00	32084	29	NTN
	620,000	150,000			154,00	323084	31	NTN
	620,000	150,000			135,00	413084	30	NTN
	620,000	188,000			172,00	423084	30	NTN
	620,000	395,000			384,00	E-CRO-8412LL	32	NTN
	620,000	395,000			384,00	CRO-8412LL	32	NTN
	650,000	460,000			600,00	CRO-8402	32	NTN
	650,000	460,000			600,00	E-CRO-8402	32	NTN
	700,000	224,000			346,00	323184	31	NTN
	700,000	224,000			317,00	413184	30	NTN
	700,000	274,000			387,00	CRI-8403	30	NTN
	700,000	280,000			394,00	423184	30	NTN
735,000	406,000			780,00	CRD-8405	31	NTN	
431,800	533,400	46,038	34,925	46,038	19,80	80385/80325	29	NTN
	533,400	46,038	34,925	46,038	19,70	T-80385/80325	29	NTN
	552,450	44,450	31,750	44,450	23,10	80170/80217	29	NTN
	571,500	74,612	52,388	74,612	21,76	LM869448/LM869410A	29	NTN
	571,500	74,612	52,388	74,612	45,70	T-LM869448/LM869410	29	NTN
	571,500	133,350			92,10	T-LM869449D/LM869410+A	31	NTN
	571,500	155,575			97,46	E-LM869448/LM869410D+A	30	NTN
	571,500	155,575			95,30	T-LM869448/LM869410D+A	30	NTN
	571,500	161,925			112,00	LM769349D/LM769310+A	31	NTN
	571,500	279,400			192,00	E-LM869449D/LM869410/LM869410D	32	NTN
	571,500	279,400			193,00	T-LM869449D/LM869410/LM869410D	32	NTN
	571,500	336,550			232,00	E-LM769349D/LM769310/LM769310D	32	NTN
	571,500	336,550			232,00	LM769349D/LM769310/LM769310D	32	NTN
	603,250	73,025	50,800	76,200	64,90	EE241701/242375	29	NTN
	603,250	159,639			124,00	EE241701/242377D+A	30	NTN
	635,000	355,600			402,00	EE931170D/931250/931251XDG2	32	NTN
	673,100	87,833	60,325	88,900	114,00	EE571703/572650	29	NTN
	673,100	192,639			225,00	EE571703/572651D+A	30	NTN



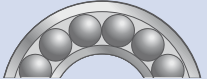



								Brands
d	D	B	C	T	Kg	Reference		
432,003	609,524	317,500			297,00	EE736173D/736238/736239D	32	NTN
	609,524	317,500			297,00	E-EE736173D/736238/736239D	32	NTN
440,000	590,000	480,000			358,00	E-CRO-8830LL	32	NTN
	590,000	480,000			358,00	CRO-8830LL	32	NTN
	600,000	95,000	82,000	100,000	76,00	32988	29	NTN
	620,000	454,000			430,00	E-625988	32	NTN
	620,000	454,000			430,00	625988 (CRO-8839)	32	NTN
	620,000	454,000			421,00	E-CRO-8823LL	32	NTN
	620,000	454,000			426,00	CRO-8832LL	32	NTN
	620,000	454,000			430,00	E-CRO-8839	32	NTN
	635,000	470,000			498,00	CRO-8808	32	NTN
	650,000	122,000	104,000	130,000	136,00	32088	29	NTN
	650,000	155,000			163,00	CRD-8808	31	NTN
	650,000	157,000			177,00	323088	31	NTN
	650,000	157,000			160,00	413088	30	NTN
	650,000	196,000			198,00	423088	30	NTN
	650,000	355,000			400,00	CRO-8807	32	NTN
	650,000	355,000			400,00	E-CRO-8807	32	NTN
	650,000	460,000			600,00	CRO-8806	32	NTN
	650,000	460,000			600,00	E-CRO-8806	32	NTN
	720,000	226,000			361,00	323188	31	NTN
	720,000	226,000			330,00	413188	30	NTN
	720,000	283,000			412,00	423188	30	NTN
730,000	290,000			513,00	CRD-8822	31	NTN	
444,675	635,000	223,838			254,00	E-M270749TD/M270710AUP	31	NTN
	552,450	41,618	32,545	44,450	20,80	E-LL469949/LL469910	29	NTN
	552,450	44,450	31,750	44,450	20,40	80176/80217	29	NTN
	635,000	120,650	95,250	120,650	107,00	M270749/M270710AG2	29	NTN
	635,000	223,838			234,00	M270749D/M270710+A	31	NTN
	635,000	223,838			224,00	M270749D/M270710AG2+A	31	NTN
	635,000	257,175			228,00	M270749/M270710DAG2+A	30	NTN
	635,000	463,550			509,00	E-M270749D/M270710/M270710DAG2	32	NTN
	635,000	463,550			509,00	M270749D/M270710/M270710DG2	32	NTN
448,000	635,000	464,000			485,00	E-CRO-9012	32	NTN
450,000	720,000	300,000			483,00	CRD-9011	31	NTN
457,200	552,450	44,450	31,750	44,450	18,70	80180/80217	29	NTN
	552,450	44,450	31,750	44,450	19,30	80180/80217A	29	NTN
	573,088	74,612	57,150	74,612	42,50	L570649/L570610	29	NTN
	573,088	74,613	57,150	74,613	43,00	CR-9111	29	NTN
	596,900	73,025	53,975	76,200	50,87	EE244180/244235	29	NTN
	596,900	133,350	52,388	133,350	96,70	L770849D/L770810+A	31	NTN
	596,900	133,350			96,70	L770847D/L770810AG2+A	31	NTN
	596,900	165,100			106,00	EE244180/244236D+A	30	NTN
	596,900	276,225			207,00	EE244181D/244235/244236D	32	NTN
	596,900	276,225			201,00	L770849D/L770810/L770810D	32	NTN
	596,900	276,225			209,00	E-L770849D/L770810/L770810DG2	32	NTN
	596,900	276,225			192,00	CRO-9107LL	32	NTN
	596,900	279,400			200,90	E-L770847D/L770810/L770810D	32	NTN
	603,250	84,138	60,325	85,725	63,80	LM770949/LM770910	29	NTN
	609,600	63,500			56,60	CRTX9102	38	NTN
	615,950	85,725	66,675	85,725	63,80	LM272235/LM272210G2	29	NTN
	660,400	323,850			379,00	EE737179D/737260/737260D	32	NTN
	660,400	323,850			379,00	E-EE737179D/737260/737260D	32	NTN
	730,148	114,300	82,550	120,650	188,00	EE671801/672873	29	NTN
	730,148	254,000			360,00	EE671801/672875D+A	30	NTN
	458,000	830,500	377,000			890,00	CRD-9203	31



							 Brands
d	D	B	C	T	Kg	Reference	
460,000	618,000	150,000			126,00	CRD-9202	31 NTN
	618,000	150,000			120,00	CRD-9211	31 NTN
	618,000	150,000			115,00	CRD-9218	31 NTN
	650,000	474,000			493,00	625992A	32 NTN
	650,000	474,000			493,00	E-625992A	32 NTN
	680,000	163,000			201,00	323092	31 NTN
	680,000	163,000			179,00	413092	30 NTN
	680,000	204,000			223,30	423092	30 NTN
	720,000	250,000			388,00	CRD-9214	31 NTN
	760,000	240,000			431,00	323192	31 NTN
	760,000	240,000			395,00	413192	30 NTN
	760,000	300,000			493,00	423192	30 NTN
	860,000	420,000			1 120,00	CRD-9204	31 NTN
	470,000	720,000	216,000			315,00	CRD-9404
475,000	620,000	380,000			294,00	E-CRO-9505	32 NTN
	660,000	450,000			465,00	CRO-9501	32 NTN
	660,000	450,000			465,00	E-CRO-9501	32 NTN
476,250	565,150	41,275	31,750	41,275	16,70	LL771948/LL771911	29 NTN
479,425	679,450	128,588	101,600	128,588	130,00	T-M272749/M272710G2	29 NTN
	679,450	238,125			293,00	E-M272749D/M272710+A	31 NTN
	679,450	238,125			272,00	M272749D/M272710+A	31 NTN
	679,450	238,125			293,00	T-M272749D/M272710G2+A	31 NTN
	679,450	238,125			261,00	CRD-9612	31 NTN
	679,450	276,225			310,00	T-M272749/M272710DG2+A	30 NTN
	679,450	495,300			565,00	CRO-9610LL	32 NTN
480,000	678,000	494,000			563,00	625996	32 NTN
	678,000	494,000			563,00	E-625996	32 NTN
	678,000	494,000			554,00	CRO-9612	32 NTN
	689,500	180,000			223,00	CRD-9609	31 NTN
	690,000	180,000			224,00	CRD-9603	31 NTN
	700,000	165,000			211,00	323096	31 NTN
	700,000	206,000			236,00	423096	30 NTN
	700,000	390,000			436,00	CRO-9602	32 NTN
	700,000	390,000			436,00	E-CRO-9602	32 NTN
	700,000	390,000			511,00	E-CRO-9609	32 NTN
	700,000	390,000			510,00	E-CRO-9619	32 NTN
	790,000	248,000			478,00	323196	31 NTN
	790,000	248,000			442,00	413196	30 NTN
	790,000	310,000			548,00	423196	30 NTN
481,228	615,950	158,750			108,00	CRD-9605	31 NTN
482,000	632,000	520,000			443,00	E-CRD-9613	31 NTN
482,600	615,950	85,725	66,675	85,725	54,90	LM272249/LM272210G2	29 NTN
	615,950	158,750			115,00	LM272249D/LM272210G2+A	31 NTN
	615,950	158,750			108,00	CRD-9709	31 NTN
	615,950	163,750			121,00	CRD-9708	31 NTN
	615,950	184,150			118,00	E-LM272249/LM272210D+A	30 NTN
	615,950	184,150			118,00	LM272249/LM272210DG2+A	30 NTN
	615,950	330,200			250,00	E-LM272249D/LM272210/LM272210DG2	32 NTN
	615,950	330,200			250,00	LM272249D/LM272210/LM272210DG2	32 NTN
	615,950	330,200			225,00	CRO-9725LL	32 NTN
	615,950	330,200			239,00	E-CRO-9737	32 NTN
	615,950	500,000			355,00	E-CRD-9716D2	31 NTN
	634,873	80,962	63,500	80,962	60,20	EE243190/243250	29 NTN
	634,873	177,800			148,00	EE243190/243251D+A	30 NTN



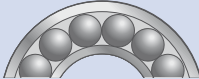



								Brands
d	D	B	C	T	Kg	Reference		
482,600	647,700	201,612			185,00	M272647D/M272610G2+A	31	NTN
	733,500	200,000			301,00	CRD-9704	31	NTN
488,950	634,873	84,138	61,912	84,138	60,30	LM772748/LM772710A	29	NTN
	634,873	180,975			130,00	LM772748/LM772710DA+A	30	NTN
	660,400	94,458	69,850	93,662	85,20	T-EE640192/640260G2	29	NTN
	660,400	206,375			178,00	T-EE640192/640261DG2+A	30	NTN
	660,400	365,125			364,00	T-EE640193D/640260/640261DG2	32	NTN
	660,400	365,125			364,00	T-E-EE640193D/640260/640261DG2	32	NTN
489,026	634,873	80,962	63,500	80,962	58,00	EE243192/243250	29	NTN
	634,873	153,988			124,00	LM772749D/LM772710A+A	31	NTN
	634,873	177,800			140,00	EE243192/243251D+A	30	NTN
	634,873	320,675			268,00	E-LM772749D/LM772710/LM772710DA	32	NTN
	634,873	320,675			268,00	LM772749D/LM772710/LM772710DA	32	NTN
498,475	634,873	80,962	63,500	80,962	59,26	EE243196/243250	29	NTN
	634,873	177,800			129,00	EE243196/243251D+A	30	NTN
500,000	640,000	500,000			346,00	CR-10010DB	30	NTN
	670,000	150,000			148,00	CRD-10005	31	NTN
	670,000	180,000			175,00	CRI-10004	30	NTN
	670,000	515,000			598,00	CRO-10008	32	NTN
	670,000	515,000			598,00	E-CRO-10008	32	NTN
	690,000	480,000			600,00	CRO-10005	32	NTN
	690,000	480,000			600,00	E-CRO-10005	32	NTN
	705,000	515,000			632,00	6259/500	32	NTN
	705,000	515,000			632,00	E-6259/500	32	NTN
	720,000	167,000			202,00	4130/500	30	NTN
	720,000	209,000			247,00	4230/500	30	NTN
	730,000	420,000			606,00	CRO-10023	32	NTN
	730,000	440,000			535,00	CRO-10003	32	NTN
	730,000	440,000			535,00	E-CRO-10003	32	NTN
	750,000	140,000	120,000	150,000	224,00	CR-10024	29	NTN
	820,000	256,000			535,00	CRD-10008	31	NTN
	830,000	264,000			528,00	4131/500	30	NTN
830,000	330,000			678,00	4231/500G2	30	NTN	
501,650	711,200	136,525	106,362	136,525	152,00	M274149/M274110G2	29	NTN
	711,200	250,825			314,00	M274149D/M274110G2+A	31	NTN
	711,200	520,700			726,00	E-M274149D/M274110/M274110DG2	32	NTN
	711,200	520,700			726,00	M274149D/M274110/M274110DG2	32	NTN
508,000	762,000	463,550			740,00	EE531201D/531300/531301XDG2	32	NTN
	838,200	139,700	104,775	146,050	296,00	EE426200/426330	29	NTN
	838,200	304,800			592,00	EE426200/426331D+A	30	NTN
509,948	654,924	377,000			320,00	CRO-10208 (CRO-10214)	32	NTN
	733,425	200,020			256,00	CRD-10208	31	NTN
	733,425	200,020			273,00	E-CRD-10211	31	NTN
510,134	800,001	284,493			511,00	CRD-10206	31	NTN
514,350	673,100	203,200			189,00	LM274449D/LM274410+A	31	NTN
	673,100	422,275			390,00	E-LM274449D/LM274410/LM274410D	32	NTN
	673,100	422,275			390,00	LM274449D/LM274410/LM274410D	32	NTN
519,112	736,600	258,762			348,00	M275349D/M275310G2+A	31	NTN
	736,600	536,575			761,00	E-M275349D/M275310/M275310DG2	32	NTN
	736,600	536,575			761,00	M275349D/M275310/M275310DG2 (CRO-10408)	32	NTN
520,000	735,000	535,000			750,00	CRO-10402	32	NTN



							 Brands
d	D	B	C	T	Kg	Reference	
520,000	735,000	535,000			750,00	E-CRO-10402	32 NTN
530,000	670,000	95,000	82,000	100,000	76,20	CR-10601	29 NTN
	670,000	270,000			198,00	CR-10604DB	30 NTN
	715,000	590,000			700,00	CRO-10607LL	32 NTN
	780,000	185,000			265,00	4130/530	30 NTN
	780,000	231,000			331,00	4230/530	30 NTN
	870,000	272,000			620,00	4131/530G2	30 NTN
	870,000	340,000			774,00	4231/530AG2	30 NTN
533,400	635,000	50,800	38,100	50,800	26,40	LL575343/LL575310	29 NTN
	736,600	225,425			268,00	CRI-10702	30 NTN
	812,800	269,875			444,00	EE626210/626321D+A	30 NTN
	965,200	495,300			1 662,00	CRO-10702	32 NTN
536,575	761,873	146,050	114,300	146,050	187,00	M276449/M276410G2	29 NTN
	761,873	146,050	247,650	311,150	398,00	M276449/M276410DG2+A	30 NTN
	761,873	269,875			389,00	M276448D/M276410G2+A	31 NTN
	761,873	269,875			389,00	M276449D/M276410G2+A	31 NTN
	761,873	558,800			890,00	E-M276449D/M276410/M276410DG2	32 NTN
	761,873	558,800			890,00	M276449D/M276410/M276410DG2	32 NTN
539,750	635,000	50,800	38,100	50,800	24,90	LL575349/LL575310	29 NTN
	784,225	339,725			552,00	EE522126D/523087/523088D	32 NTN
549,275	692,150	80,962	61,912	80,962	68,20	L476549/L476510	29 NTN
	692,150	174,625			135,00	L476549/L476510D+A	30 NTN
550,000	760,000	230,000			296,00	E-CRT1002	37 NTN
	920,000	330,000			914,00	CRD-11001	31 NTN
555,625	698,500	349,250			298,00	CRO-11101 (CRO-11103)	32 NTN
558,800	736,600	76,200	50,800	76,200	76,70	EE542220/542290	29 NTN
	736,600	88,108	63,500	88,108	92,00	EE843220/843290	29 NTN
	736,600	104,775	80,962	104,775	106,00	LM377449/LM377410	29 NTN
	736,600	155,575			177,00	EE843220D/843290+A	31 NTN
	736,600	165,100			166,00	EE542220/542291D+A	30 NTN
	736,600	187,328			189,00	EE843220/843291D+A	30 NTN
	736,600	196,850			224,00	E-LM377449D/LM377410+A	31 NTN
	736,600	196,850			223,00	LM377449D/LM377410G2+A	31 NTN
	736,600	225,425			227,00	LM377449/LM377410D+A	30 NTN
	736,600	322,265			388,00	E-EE843221D/843290/843291D	32 NTN
	736,600	322,265			388,00	EE843221D/843290/843291D (CRO-11217)	32 NTN
	736,600	409,575			502,00	E-LM377449D/LM377410/LM377410DG2	32 NTN
	736,600	409,575			502,00	LM377449D/LM377410/LM377410DG2 (CRO-11216)	32 NTN
558,952	736,600	104,775	80,962	104,775	114,00	E-CR-11221	29 NTN
560,000	735,000	225,000			224,00	CRI-11206	30 NTN
	735,000	225,000			232,00	CRI-11206	30 NTN
	736,000	104,775	80,962	104,775	104,78	E-CR-11220	29 NTN
	740,000	190,000			198,00	CRI-11211	30 NTN
	820,000	195,000			347,00	CRD-11207	31 NTN
	820,000	195,000			340,00	CRI-11214	30 NTN
	820,000	244,000			415,00	CRI-11213	30 NTN
	920,000	280,000			1 310,00	4131/560	30 NTN
	920,000	350,000			894,00	4231/560G2	30 NTN
570,000	695,000	52,000	50,000	57,000	41,70	CR-11402	29 NTN
	780,000	515,000			625,00	CRO-11402	32 NTN
	780,000	515,000			625,00	E-CRO-11402	32 NTN



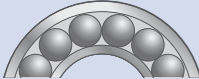



								Brands	
d	D	B	C	T	Kg	Reference			
570,000	810,000	590,000			845,00	CRO-11403	32	NTN	
	810,000	590,000			845,00	E-CRO-11403	32	NTN	
	815,000	345,000			512,00	CRI-11401	30	NTN	
571,500	812,800	155,575	120,650	155,575	227,00	M278749/M278710AG2	29	NTN	
	812,800	285,750			470,00	M278749D/M278710AG2+A	31	NTN	
	812,800	333,375			487,00	M278749/M278710DAG2+A	30	NTN	
	812,800	593,725			1 080,00	E-M278749D/M278710/M278710DAG2	32	NTN	
	812,800	593,725			1 080,00	M278749D/M278710/M278710DAG2	32	NTN	
584,200	685,800	49,212	34,925	49,212	27,80	T-LL778149/LL778110	29	NTN	
	762,000	188,912	169,862	396,875	511,00	LM778549D/LM778510/LM778510DG2	32	NTN	
	762,000	188,912			223,00	LM778549D/LM778510G2+A	31	NTN	
	762,000	396,875			511,00	E-LM778549D/LM778510/LM778510DG2	32	NTN	
	771,525	230,188			285,00	CRD-11701	31	NTN	
	771,525	479,425			610,00	CRO-11701	32	NTN	
	771,525	479,425			750,00	E-LM278849D/LM278810/LM278810D	32	NTN	
	771,525	479,425			750,00	LM278849D/LM278810/LM278810D	32	NTN	
590,000	780,000	255,000			291,00	CRI-11801	30	NTN	
595,312	844,550	296,862			525,00	M280049D/M280010G2+A	31	NTN	
	844,550	615,950			1 135,00	CRO-11913	32	NTN	
	844,550	615,950			1 130,00	CRO-11919LL	32	NTN	
	844,550	615,950			1 160,00	E-M280049D/M280010/M280010DG2	32	NTN	
	844,550	615,950			1 160,00	M280049D/M280010/M280010DG2	32	NTN	
	857,250	590,550			1 020,00	E-LM281031T/LM281044TD/LM281048T/LM2	32	NTN	
596,900	685,800	31,750			15,80	680235/680270	29	NTN	
600,000	760,000	115,000			120,00	CRD-12005	31	NTN	
	820,000	160,000			253,00	E-CRD-12011	31	NTN	
	870,000	111,000	93,000	118,000	208,70	CR-12006	29	NTN	
	870,000	200,000			348,00	4130/600	30	NTN	
	870,000	380,000			758,00	CRD-12006	31	NTN	
	980,000	300,000			858,00	4131/600G2	30	NTN	
	980,000	388,000			1 050,00	4231/600G2	30	NTN	
	1 000,000	350,000			1 130,00	CRD-12002	31	NTN	
602,945	787,400	206,375			246,00	EE649237/649311D+A	30	NTN	
	787,400	206,375			246,00	E-EE649237/649311D+A	30	NTN	
609,396	762,000	92,075	71,438	95,250	95,70	L879946/L879910	29	NTN	
609,600	762,000	92,075	71,438	95,250	95,60	L879947/L879910	29	NTN	
	787,400	93,662	69,850	93,662	112,00	E-EE649240/649310	29	NTN	
	787,400	93,662	69,850	93,662	112,00	EE649240/649310G2	29	NTN	
	787,400	171,450			210,00	T-EE649241D/649310G2+A	31	NTN	
	787,400	206,375			235,00	EE649240/649311DG2+A	30	NTN	
	787,400	361,950			458,00	EE649241D/649310/649311DG2	32	NTN	
	787,400	361,950			458,00	E-EE649241D/649310/649311DG2	32	NTN	
	812,800	82,550	60,325	82,550	104,00	EE743240/743320	29	NTN	
	812,800	190,500			241,00	EE743240/743321D+A	30	NTN	
	863,600	317,500			585,00	M280349D/M280310G2+A	31	NTN	
	863,600	660,400			1 250,00	M280349D/M280310/M280310DG2	32	NTN	
	611,500	832,800	593,725			960,00	CRO-12202	32	NTN
	630,000	920,000	600,000			1 390,00	CRO-12604	32	NTN
736,600		53,975	41,275	57,150	38,30	80780/80720	29	NTN	
812,800		95,250	73,025	95,250	118,60	CR-12702	29	NTN	
850,000		105,000	75,000	105,000	151,00	CR-12701	29	NTN	







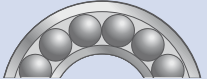

							 Brands	
d	D	B	C	T	Kg	Reference		
635,000	901,700	317,500			641,00	M281049D/M281010G2+A	31	NTN
650,000	1 030,000	560,000			1 760,00	CRO-13001	32	NTN
657,225	933,450	328,612			711,00	M281649D/M281610G2+A	31	NTN
	933,450	676,275			1 630,00	E-M281649D/M281610/M281610DG2	32	NTN
	933,450	676,275			1 630,00	M281649D/M281610/M281610DG2	32	NTN
660,000	814,000	176,212			202,00	CRD-13208	31	NTN
	1 070,000	642,000			1 950,00	CRO-13202	32	NTN
	1 070,000	642,000			1 950,00	E-CRO-13202	32	NTN
660,400	762,000	98,425			71,10	CRD-13209	31	NTN
	812,800	95,250	73,025	95,250	93,50	L281148/L281110A	29	NTN
	812,800	176,212			195,00	L281149D/L281110G2+A	31	NTN
	812,800	203,200			199,00	L281148/L281110DA+A	30	NTN
	812,800	365,125			448,00	E-L281149D/L281110/L281110DG2	32	NTN
	812,800	365,125			448,00	L281149D/L281110/L281110DG2	32	NTN
670,000	830,000	180,000			201,00	CRI-13402	30	NTN
	880,000	185,000			277,00	CRI-13401	30	NTN
	960,000	700,000			1 600,00	CRO-13401	32	NTN
	1 090,000	336,000			1 180,00	4131/670G2	30	NTN
	1 090,000	392,000			1 410,00	4231/670G2	30	NTN
	1 090,000	710,000			2 600,00	CRO-13402	32	NTN
	1 090,000	710,000			2 690,00	CRO-13404	32	NTN
673,100	793,750	61,912	49,212	66,675	51,30	LL481448/LL481411	29	NTN
679,450	901,700	265,112			459,00	LM281849D/LM281810G2+A	31	NTN
	901,700	552,450			1 040,00	E-LM281849D/LM281810/LM281810DG2	32	NTN
	901,700	552,450			1 040,00	LM281849D/LM281810/LM281810DG2	32	NTN
680,000	870,000	460,000			582,00	CRO-13602	32	NTN
	870,000	460,000			582,00	E-CRO-13602	32	NTN
682,625	965,200	701,675			1 770,00	E-M282249D/M282210/M282210DG2	32	NTN
	965,200	701,675			1 770,00	M282249D/M282210/M282210DG2	32	NTN
685,800	876,300	92,075	69,850	93,662	134,00	EE655270/655345G2	29	NTN
	876,300	168,275			247,00	EE655271D/655345G2+A	31	NTN
	876,300	352,425			539,00	E-EE655271D/655345/655346DG2	32	NTN
	876,300	352,425			539,00	EE655271D/655345/655346DG2 (CRO-13708)	32	NTN
	876,300	355,600			539,00	E-EE655271D/655345/655346D	32	NTN
	939,800	234,950			478,00	CRD-13702	31	NTN
685,876	939,876	234,950			435,00	CRD-13701	31	NTN
700,000	850,000	93,000	74,000	96,000	106,00	CR-14003	29	NTN
	890,000	150,000			224,00	CRD-14003	31	NTN
708,025	930,275	273,050			490,00	LM282549D/LM282510G2+A	31	NTN
710,000	900,000	410,000			620,00	CRO-14208	32	NTN
	900,000	410,000			620,00	E-CRO-14208	32	NTN
	1 030,000	236,000			654,00	CRI-14207	30	NTN
	1 030,000	236,000			640,00	4130/710G2	30	NTN
	1 030,000	295,000			810,00	CRI-14209	30	NTN
711,200	914,400	82,550	60,325	85,725	136,00	EE755280/755360G2	29	NTN
	914,400	149,225			243,00	EE755281D/755360G2+A	31	NTN
	914,400	190,500			275,00	EE755280/755361DG2+A	30	NTN





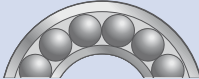

								Brands
d	D	B	C	T	Kg	Reference		
711,200	914,400	317,500			527,00	EE755280D/755360/755361DG2	32	NTN
	914,400	317,500			527,00	EE755281D/755360/755361DG2	32	NTN
	914,400	317,500			527,00	E-EE755281D/755360/755361DG2	32	NTN
	914,400	387,350			616,00	CRO-14214LL	32	NTN
	914,400	410,000			596,00	CRO-14209LL	32	NTN
720,000	880,000	75,000	60,000	80,000	94,00	CR-14403	29	NTN
	880,000	210,000			244,00	CR1-14402	30	NTN
	920,000	130,000			240,00	CRD-14403	31	NTN
	1 060,000	545,000			1 400,00	E-CRD-14402LL	31	NTN
723,900	914,400	80,962	60,325	84,138	126,00	EE755285/755360G2	29	NTN
	914,400	187,325			256,00	EE755285/755361DG2+A	30	NTN
730,000	1 070,000	642,000			1 900,00	CRO-14601	32	NTN
	1 070,000	642,000			1 900,00	E-CRO-14601	32	NTN
730,250	1 035,050	755,650			2 210,00	M283449D/M283410/M283410D	31	NTN
	1 035,050	755,650			2 210,00	E-M283449D/M283410/M283410DG2	32	NTN
740,000	900,000	75,000	65,000	80,000	96,00	CR-14803	29	NTN
745,000	1 000,000	115,000	83,000	115,000	237,00	CR-14901	29	NTN
749,300	958,000	127,000			245,00	CRT15001	37	NTN
	965,200	362,320			660,00	EE752295/752380DB	30	NTN
	990,600	160,337	123,000	159,500	309,00	LM283649/LM283610G2	29	NTN
	990,600	293,000			606,00	LM283649D/LM283610G2+A	31	NTN
	990,600	605,000			1 310,00	E-LM283649D/LM283610/LM283610DG2	32	NTN
	990,600	605,000			1 250,00	LM283649D/LM283610/LM283610DG2	32	NTN
750,000	1 000,000	107,000	80,000	110,000	210,00	CR-15002	29	NTN
	1 075,000	320,000			955,00	CRD-15001	31	NTN
759,925	889,000	69,850	50,800	69,850	70,50	E-LL483448/LL483418	29	NTN
762,000	1 066,800	352,425			968,00	M284148D/M284111G2+A	31	NTN
	1 066,800	723,900			2 220,00	M284148D/M284111/M284110DG2	32	NTN
	1 079,500	381,000			1 097,00	M284249D/M284210G2+A	31	NTN
	1 079,500	787,400			2 480,00	E-M284249D/M284210/M284210DG2	32	NTN
	1 079,500	787,400			2 480,00	M284249D/M284210/M284210DG2	32	NTN
774,700	965,200	80,962	66,675	93,662	126,00	EE752305/752380	29	NTN
780,000	925,000	92,000	75,000	95,000	115,00	CR-15602	29	NTN
	925,000	92,000	75,000	95,000	103,00	E-CR-15602	29	NTN
	1 000,000	200,000			384,00	CRD-15601	31	NTN
800,000	1 120,000	820,000			3 960,00	CRO-16001	32	NTN
	1 120,000	820,000			3 960,00	E-CRO-16001	32	NTN
	1 150,000	350,000			1 119,00	CRI-16001	30	NTN
812,800	1 066,800	190,500			410,00	CR1-16301	30	NTN
825,500	1 168,400	844,550			3 010,00	E-M285848D/M285810/M285810DG2	32	NTN
	1 168,400	844,550			3 010,00	M285848D/M285810/M285810DG2	32	NTN
838,200	1 041,400	88,900	66,675	93,662	172,00	EE763330/763410G2	29	NTN
840,000	1 170,000	840,000			3 970,00	CRO-16803	32	NTN
	1 170,000	840,000			3 970,00	E-CRO-16803	32	NTN



							 Brands
d	D	B	C	T	Kg	Reference	
850,000	1 120,000	112,000	80,000	118,000	276,00	CR-17001	29 NTN
	1 250,000	370,000			1 562,00	CRD-17003	31 NTN
863,600	1 130,300	323,850			848,00	LM286249D/LM286210G2+A	31 NTN
	1 130,300	669,925			1 950,00	E-LM286249D/LM286210/LM286210DG2	32 NTN
	1 130,300	669,925			1 950,00	LM286249D/LM286210/LM286210DG2	32 NTN
	1 219,200	425,450			1 552,00	EE547341D/547480G2+A	31 NTN
	1 219,200	876,300			3 640,00	E-EE547341D/547480/547481DG2	32 NTN
	1 219,200	876,300			3 640,00	EE547341D/547480/547481DG2 (CRO-17301)	32 NTN
900,000	1 120,000	430,000			785,00	CR-18011DB	30 NTN
920,000	1 120,000	150,000			269,00	CRT18401	37 NTN
928,000	1 060,000	90,000	76,000	92,000	116,00	E-CR-18605	29 NTN
930,000	1 060,000	90,000	76,000	92,000	114,00	E-CR-18604	29 NTN
938,212	1 270,000	400,050			1 444,00	LM287649D/LM287610G2+A	31 NTN
	1 270,000	825,500			4 100,00	E-LM287649D/LM287610/LM287610DG2	32 NTN
	1 270,000	825,500			4 100,00	LM287649D/LM287610/LM287610DG2	32 NTN
939,800	1 333,500	349,250			1 540,00	LM287849D/LM287810G2+A	31 NTN
950,000	1 360,000	880,000			4 100,00	CRO-19001	32 NTN
	1 360,000	880,000			4 100,00	E-CRO-19001	32 NTN
977,900	1 130,300	63,500	47,625	66,675	103,00	LL687949/LL687910	29 NTN
	1 130,300	139,700			196,00	LL687949/LL687910D+A	30 NTN
1 040,000	1 290,000	350,000			975,00	CRI-20802	30 NTN
1 063,625	1 219,200	65,088	42,862	65,088	422,00	LL788345/LL788310	29 NTN
1 066,800	1 219,200	65,088	42,862	65,088	422,00	LL788349/LL788310	29 NTN
	1 320,800	88,900	69,850	95,250	796,00	EE776420/776520	29 NTN
1 092,200	1 320,800	88,900	69,850	95,250	794,00	EE776430/776520	29 NTN
1 115,000	1 460,000	300,000			1 255,00	CRI-22303	30 NTN
1 155,700	1 435,100	120,650	95,250	120,650	428,00	E-EE277455/277565	29 NTN
1 200,150	1 593,850	990,600			6 130,00	E-LM288949D/LM288910/LM288910DG2	32 NTN
	1 593,850	990,600			6 130,00	LM288949D/LM288910/LM288910DG2	32 NTN
1 270,000	1 435,100	65,088	47,625	69,850	666,00	LL889049/LL889010	29 NTN
	1 435,100	146,050			285,00	LL889049/LL889010D+A	30 NTN
1 400,000	1 600,000	180,000			534,00	CRD-28003	31 NTN
	31,991		7,938		0,02	4T-A2126	29 NTN
	34,988		8,712		0,02	4T-L21511	29 NTN
	34,988		8,730		0,02	4T-A4138	29 NTN
	39,878		10,668		0,03	4T-LM11710	29 NTN
	39,992		9,525		0,03	4T-A6157	29 NTN
	41,275		8,730		0,03	4T-A6162	29 NTN
	41,275		11,112		0,04	4T-03162	29 NTN
	42,862		9,525		0,04	4T-11520	29 NTN
	42,862		13,495		0,05	4T-17520	29 NTN
	44,450		11,430		0,03	4T-05175	29 NTN
	45,237		12,065		0,04	4T-LM11910	29 NTN



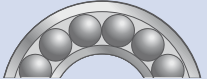



								Brands
d	D	B	C	T	Kg	Reference		
	45,237		12,065		0,04	4T-LM12710	29	NTN
	45,974		12,065		0,04	4T-LM12711	29	NTN
	47,000		11,112		0,05	4T-05185	29	NTN
	47,000		11,112		0,05	4T-05185S	29	NTN
	47,000		12,000		0,05	4T-LM72810	29	NTN
	47,000		16,000		0,08	4T-HM81610	29	NTN
	49,225		14,288		0,07	4T-09195	29	NTN
	49,225		15,875		0,07	4T-12520	29	NTN
	49,225		17,462		0,08	4T-09194	29	NTN
	49,225		17,462		0,08	4T-09196	29	NTN
	50,005		9,525		0,03	4T-07196	29	NTN
	50,005		13,970		0,06	4T-M12610	29	NTN
	50,292		10,668		0,04	4T-L44610	29	NTN
	50,292		10,668		0,04	4T-L45410	29	NTN
	50,800		12,700		0,05	4T-07210X	29	NTN
	51,994		12,700		0,06	4T-07204	29	NTN
	52,000		12,700		0,06	4T-07205	29	NTN
	52,388		14,288		0,07	4T-1328	29	NTN
	53,000		11,500		0,04	4T-JL26710	29	NTN
	53,975		14,288		0,08	4T-1329	29	NTN
	53,975		15,875		0,07	4T-1730	29	NTN
	53,975		15,875		0,10	4T-21212	29	NTN
	56,896		15,875		0,10	4T-1729X	29	NTN
	56,896		15,875		0,10	4T-1729	29	NTN
	56,896		15,875		0,07	4T-1930	29	NTN
	57,150		13,495		0,07	4T-15520	29	NTN
	57,150		14,732		0,09	4T-M84510	29	NTN
	57,150		15,875		0,08	4T-1922	29	NTN
	57,150		17,462		0,11	4T-1220	29	NTN
	58,738		15,080		0,09	4T-1932	29	NTN
	59,131		11,811		0,06	4T-LM67010XL	29	NTN
	59,131		11,811		0,06	4T-LM67010	29	NTN
	59,131		11,938		0,06	4T-L68110	29	NTN
	59,530		18,288		0,13	4T-M84210	29	NTN
	59,974		11,938		0,06	4T-L68111	29	NTN
	60,000		11,938		0,06	4T-JL68111Z	29	NTN
	60,325		15,875		0,16	4T-15523	29	NTN
	60,325		15,875		0,11	4T-1931	29	NTN
	61,912		14,288		0,08	4T-15243	29	NTN
	61,973		13,600		0,07	4T-LM78310A	29	NTN
	62,000		14,288		0,08	4T-15245	29	NTN
	62,000		14,288		0,09	4T-17244	29	NTN
	62,000		15,875		0,08	4T-15244	29	NTN
	63,000		13,500		0,07	4T-JL69310	29	NTN
	63,100		19,050		0,11	4T-2620	29	NTN
	63,500		9,525		0,05	4T-13830	29	NTN
	63,500		15,875		0,11	4T-15250	29	NTN
	63,500		15,875		0,11	4T-15250X	29	NTN
	64,292		16,670		0,13	4T-M86610	29	NTN
	65,088		9,525		0,06	4T-13836	29	NTN
	65,088		13,970		0,08	4T-LM29710	29	NTN
	65,088		13,970		0,08	4T-LM48510	29	NTN
	65,088		15,748		0,09	4T-LM29711	29	NTN
	65,088		15,875		0,14	4T-23256	29	NTN
	65,088		18,034		0,10	4T-LM48510XL	29	NTN
	66,421		19,050		0,16	4T-2631	29	NTN
	66,421		20,638		0,12	4T-2520	29	NTN
	68,000		13,500		0,08	4T-LM300811	29	NTN
	68,262		11,908		0,07	4T-19268	29	NTN
	68,262		17,462		0,15	4T-02420	29	NTN
	68,262		17,462		0,14	4T-M88010	29	NTN
	68,262		22,225		0,17	4T-23420	29	NTN



							 Brands
d	D	B	C	T	Kg	Reference	
	68,288		17,462		0,14	4T-2420	29 NTN
	69,012		15,083		0,10	4T-13620	29 NTN
	69,012		15,083		0,10	4T-13621	29 NTN
	69,012		15,875		0,13	4T-14276	29 NTN
	69,012		15,875		0,13	4T-14274	29 NTN
	69,850		19,050		0,17	4T-2523S	29 NTN
	69,850		19,050		0,17	4T-2523	29 NTN
	71,996		15,032		0,16	4T-14282	29 NTN
	72,000		14,237		0,12	4T-16282	29 NTN
	72,000		14,288		0,13	4T-19283X	29 NTN
	72,085		18,415		0,21	4T-14283	29 NTN
	72,238		15,875		0,14	4T-16284	29 NTN
	72,238		19,050		0,18	4T-16283	29 NTN
	72,258		19,842		0,19	4T-HM88610	29 NTN
	72,626		17,462		0,18	4T-41286	29 NTN
	72,626		23,812		0,22	4T-3120	29 NTN
	72,652		23,812		0,23	4T-3130	29 NTN
	73,025		12,700		0,08	4T-18520	29 NTN
	73,025		17,462		0,15	4T-2820	29 NTN
	73,025		17,462		0,16	4T-02820	29 NTN
	73,025		19,050		0,16	4T-25820	29 NTN
	73,025		19,050		0,17	4T-25821	29 NTN
	73,025		19,050		0,14	4T-2735X	29 NTN
	73,025		21,336		0,17	4T-M201011	29 NTN
	73,025		23,020		0,24	4T-HM88510	29 NTN
	73,431		14,732		0,11	4T-LM501310	29 NTN
	73,431		15,748		0,10	4T-LM102910	29 NTN
	73,431		16,604		0,13	4T-LM501314	29 NTN
	73,431		17,620		0,12	4T-LM102911	29 NTN
	73,431		18,186		0,14	4T-LM501311	29 NTN
	75,000		14,000		0,09	4T-LM503310	29 NTN
	76,200		14,288		0,13	4T-11300	29 NTN
	76,200		15,507		0,14	4T-28300	29 NTN
	76,200		17,462		0,15	4T-24720	29 NTN
	76,200		19,050		0,18	4T-2720	29 NTN
	76,200		19,050		0,19	4T-2729	29 NTN
	76,200		19,050		0,19	4T-2729X	29 NTN
	76,200		20,638		0,19	4T-24721	29 NTN
	76,200		20,638		0,14	4T-26823	29 NTN
	76,200		23,020		0,26	4T-HM89411	29 NTN
	76,200		23,812		0,24	4T-31521	29 NTN
	76,200		23,812		0,23	4T-31520	29 NTN
	76,225		23,020		0,25	4T-HM89410	29 NTN
	76,992		11,908		0,10	4T-12303	29 NTN
	77,788		15,080		0,12	4T-LM603011	29 NTN
	77,788		16,667		0,14	4T-LM603012	29 NTN
	78,000		15,000		0,12	4T-JLM603013Z	29 NTN
	79,375		13,495		0,12	4T-18620	29 NTN
	79,375		15,875		0,13	4T-17830	29 NTN
	79,375		17,462		0,22	4T-43312	29 NTN
	79,375		19,050		0,19	4T-26822	29 NTN
	79,375		22,664		0,25	4T-HM89210	29 NTN
	79,375		23,812		0,25	4T-3420	29 NTN
	79,985		15,080		0,13	4T-17831SA	29 NTN
	79,985		15,080		0,13	4T-17831	29 NTN
	80,000		15,080		0,15	4T-LM603014	29 NTN
	80,000		17,826		0,14	4T-332	29 NTN
	80,000		19,050		0,20	4T-26824	29 NTN
	80,000		21,000		0,18	4T-332A	29 NTN
	80,035		15,875		0,20	4T-28317	29 NTN
	80,035		18,512		0,21	4T-27820	29 NTN
	80,167		20,638		0,21	4T-26820	29 NTN



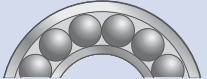



								Brands
d	D	B	C	T	Kg	Reference		
	80,167		20,638		0,22	4T-26830	29	NTN
	80,167		23,812		0,21	4T-3320	29	NTN
	82,000		17,000		0,13	4T-JLM104910	29	NTN
	82,550		16,510		0,13	4T-LM104911	29	NTN
	82,550		18,542		0,16	4T-LM104911A	29	NTN
	82,550		19,050		0,19	4T-25519	29	NTN
	82,550		20,193		0,23	4T-M802011	29	NTN
	82,550		20,638		0,22	4T-22720	29	NTN
	82,550		23,020		0,28	4T-HM801310	29	NTN
	82,931		16,510		0,14	4T-LM104912	29	NTN
	82,931		19,050		0,20	4T-25520	29	NTN
	82,931		22,225		0,23	4T-25523	29	NTN
	83,058		19,050		0,20	4T-25521	29	NTN
	83,058		19,114		0,20	4T-25522	29	NTN
	84,000		17,500		0,16	4T-JLM704610	29	NTN
	84,138		23,812		0,22	4T-3520	29	NTN
	85,000		13,495		0,13	4T-18720	29	NTN
	85,000		17,462		0,16	4T-354X	29	NTN
	85,000		20,638		0,22	4T-2924	29	NTN
	85,027		17,462		0,16	4T-354A	29	NTN
	85,027		19,050		0,24	4T-25526	29	NTN
	85,725		23,812		0,29	4T-3821	29	NTN
	85,750		23,812		0,28	4T-3820	29	NTN
	87,312		23,812		0,30	4T-3525	29	NTN
	87,338		23,813		0,31	4T-3526X	29	NTN
	88,500		17,462		0,24	4T-44348	29	NTN
	88,501		22,225		0,32	4T-414A	29	NTN
	88,501		22,225		0,33	4T-414	29	NTN
	88,900		13,492		0,13	4T-LM806610	29	NTN
	88,900		19,050		0,21	4T-M804010	29	NTN
	88,925		16,513		0,16	4T-362A	29	NTN
	88,925		23,020		0,32	4T-HM803110	29	NTN
	89,980		19,987		0,20	4T-28520	29	NTN
	90,000		15,875		0,17	4T-362	29	NTN
	90,000		18,500		0,18	4T-JLM506810	29	NTN
	90,000		20,000		0,24	4T-363	29	NTN
	90,000		20,500		0,21	4T-JLM506811	29	NTN
	90,000		23,000		0,24	4T-JM205110	29	NTN
	90,119		21,808		0,32	4T-352	29	NTN
	90,513		33,338		0,46	4T-4335	29	NTN
	91,000		26,500		0,31	4T-HM204010	29	NTN
	92,075		16,670		0,24	4T-M903310	29	NTN
	92,075		19,845		0,24	4T-28521	29	NTN
	92,075		23,020		0,39	4T-HM803112	29	NTN
	93,264		22,225		0,24	4T-33820B	29	NTN
	93,264		23,812		0,29	4T-3720	29	NTN
	93,264		23,812		0,30	4T-3730	29	NTN
	93,662		25,400		0,36	4T-49368	29	NTN
	93,662		26,195		0,40	4T-46368	29	NTN
	94,458		15,083		0,16	4T-L610510	29	NTN
	95,000		19,000		0,19	4T-JLM508710	29	NTN
	95,000		23,500		0,26	4T-JM207010	29	NTN
	95,250		20,638		0,36	4T-53377	29	NTN
	95,250		20,638		0,37	4T-53375	29	NTN
	95,250		22,225		0,26	4T-33821	29	NTN
	95,250		22,225		0,27	4T-33822	29	NTN
	95,250		22,225		0,38	4T-432	29	NTN
	95,250		22,225		0,39	4T-HM903210	29	NTN
	95,250		23,020		0,35	4T-HM804810	29	NTN
	95,250		23,812		0,35	4T-3726	29	NTN
	96,838		20,274		0,24	4T-382S	29	NTN
	96,863		15,875		0,18	4T-382A	29	NTN



							 Brands
d	D	B	C	T	Kg	Reference	
	97,630		19,446		0,27	4T-28622	29 NTN
	98,425		17,826		0,22	4T-382	29 NTN
	98,425		23,812		0,43	4T-3732	29 NTN
	99,979		19,050		0,22	4T-28919	29 NTN
	100,000		17,826		0,26	4T-383A	29 NTN
	100,000		19,845		0,23	4T-28921	29 NTN
	101,600		15,083		0,18	4T-L713010	29 NTN
	101,600		19,845		0,27	4T-28920	29 NTN
	101,600		25,400		0,38	4T-49520	29 NTN
	101,600		26,988		0,41	4T-522	29 NTN
	103,188		36,512		0,63	4T-5335	29 NTN
	103,213		11,989		0,12	4T-L812111	29 NTN
	104,775		15,875		0,18	4T-39412	29 NTN
	104,775		23,812		0,35	4T-45221	29 NTN
	104,775		23,812		0,34	4T-45220	29 NTN
	104,775		24,605		0,37	4T-453X	29 NTN
	104,775		28,575		0,47	4T-59412	29 NTN
	104,775		28,575		0,49	4T-HM807010	29 NTN
	104,775		28,575		0,50	4T-HM807011	29 NTN
	104,986		23,368		0,49	4T-HM905810	29 NTN
	105,000		18,500		0,23	4T-JLM710910	29 NTN
	105,000		29,000		0,52	4T-JHM807012	29 NTN
	107,950		19,050		0,28	4T-29522	29 NTN
	107,950		19,050		0,27	4T-29520	29 NTN
	107,950		20,320		0,31	4T-M111012	29 NTN
	107,950		27,000		0,49	4T-452A	29 NTN
	107,950		27,000		0,48	4T-453	29 NTN
	107,950		28,575		0,57	4T-532X	29 NTN
	107,975		22,225		0,42	4T-453A	29 NTN
	110,000		18,824		0,26	4T-394A	29 NTN
	110,000		18,824		0,29	4T-394AB	29 NTN
	110,000		19,050		0,33	4T-29521	29 NTN
	110,000		20,500		0,30	4T-JLM813010	29 NTN
	110,000		22,000		0,28	4T-394	29 NTN
	110,000		22,500		0,34	4T-JM511910	29 NTN
	110,000		27,000		0,55	4T-454	29 NTN
	110,000		32,000		0,56	4T-JH307710	29 NTN
	110,025		18,824		0,26	4T-394AS	29 NTN
	111,125		20,638		0,51	4T-55437	29 NTN
	111,125		20,638		0,50	4T-HM907614	29 NTN
	111,125		30,162		0,74	4T-532A	29 NTN
	112,712		19,050		0,27	4T-29620	29 NTN
	112,712		20,638		0,55	4T-55443	29 NTN
	112,712		23,812		0,45	4T-3920	29 NTN
	112,712		23,812		0,45	4T-3925	29 NTN
	112,712		23,812		0,35	4T-39520	29 NTN
	112,712		23,812		0,36	4T-39521	29 NTN
	113,487		18,824		0,35	4T-394CS	29 NTN
	114,300		34,925		0,87	4T-65320	29 NTN
	114,300		36,068		0,83	4T-HH506310	29 NTN
	115,000		19,000		0,27	4T-JLM714110	29 NTN
	115,000		23,000		0,36	4T-JM612910	29 NTN
	117,475		19,050		0,29	4T-LM814810	29 NTN
	117,475		23,812		0,43	4T-33462	29 NTN
	117,475		23,812		0,54	4T-66462	29 NTN
	120,000		23,444		0,52	4T-33472	29 NTN
	120,000		23,444		0,46	4T-472A	29 NTN
	120,000		24,237		0,49	4T-472	29 NTN
	120,000		25,000		0,42	4T-JM714210	29 NTN
	120,000		26,195		0,47	4T-47420	29 NTN
	120,000		32,000		0,61	4T-JH211710	29 NTN
	120,650		19,050		0,48	4T-29630	29 NTN

								Brands
d	D	B	C	T	Kg	Reference		
	120,650		31,750		0,85	4T-612	29	NTN
	121,442		17,462		0,31	4T-34478	29	NTN
	122,238		23,812		0,55	4T-66520	29	NTN
	122,238		29,718		0,60	4T-HM212010	29	NTN
	122,238		29,718		0,59	4T-HM212011	29	NTN
	122,238		30,162		0,68	4T-553X	29	NTN
	122,238		36,512		0,80	4T-5535	29	NTN
	123,825		16,670		0,23	4T-L217810	29	NTN
	123,825		25,400		0,78	4T-72487	29	NTN
	123,825		30,162		0,75	4T-552A	29	NTN
	123,825		33,338		0,80	4T-552	29	NTN
	124,000		34,000		0,68	4T-H212710	29	NTN
	125,412		19,845		0,34	4T-27620	29	NTN
	127,000		19,842		0,53	4T-34500	29	NTN
	127,000		22,225		0,42	4T-42620	29	NTN
	127,000		26,988		0,60	4T-HM813810	29	NTN
	127,000		28,575		0,64	4T-563	29	NTN
	127,000		34,925		1,02	4T-65500	29	NTN
	127,000		41,275		1,21	4T-6220	29	NTN
	130,000		24,000		0,45	4T-JM716610	29	NTN
	130,000		28,500		0,57	4T-JM515610	29	NTN
	130,175		16,670		0,25	4T-L319210	29	NTN
	130,175		23,812		0,68	4T-HM911210	29	NTN
	130,175		31,750		0,71	4T-633	29	NTN
	132,000		32,000		0,66	4T-HM215210	29	NTN
	133,350		22,225		0,42	4T-492A	29	NTN
	133,350		26,195		0,56	4T-47620	29	NTN
	133,350		26,195		0,58	4T-47620A	29	NTN
	133,350		32,545		0,76	4T-HM516410	29	NTN
	135,000		14,000		0,26	4T-JL819310	29	NTN
	135,755		44,450		1,38	4T-6320	29	NTN
	136,525		31,750		1,03	4T-632	29	NTN
	136,525		22,225		0,54	4T-493	29	NTN
	136,525		23,520		0,77	4T-78537	29	NTN
	136,525		31,750		0,79	4T-H414210	29	NTN
	136,525		36,512		0,94	4T-H715311	29	NTN
	139,700		28,575		0,76	4T-572X	29	NTN
	139,992		28,575		0,78	4T-572	29	NTN
	140,000		31,500		0,76	4T-JHM516810	29	NTN
	140,030		23,520		0,92	4T-78551	29	NTN
	142,138		33,338		1,07	4T-HM515716	29	NTN
	142,138		34,133		0,90	4T-HM617010	29	NTN
	145,000		27,000		0,65	4T-JM718110	29	NTN
	145,000		42,000		1,19	4T-JH415610	29	NTN
	146,050		25,400		0,90	4T-H913810	29	NTN
	146,050		26,195		0,66	4T-47820	29	NTN
	146,050		31,750		0,90	4T-653	29	NTN
	147,000		32,500		0,78	4T-HM218210	29	NTN
	148,430		21,433		0,54	4T-42584	29	NTN
	149,225		24,608		0,71	4T-42587B	29	NTN
	149,225		24,608		0,71	4T-42587	29	NTN
	149,225		44,450		1,63	4T-6420	29	NTN
	150,000		27,000		0,76	4T-593X	29	NTN
	150,000		27,000		0,77	4T-JM719113	29	NTN
	150,000		35,000		1,03	4T-743	29	NTN
	150,000		38,000		1,09	4T-JH217210	29	NTN
	150,089		36,512		1,10	4T-742	29	NTN
	152,400		30,162		0,76	4T-HM518410	29	NTN
	152,400		30,162		1,04	4T-592A	29	NTN
	152,400		31,750		1,28	4T-9121	29	NTN
	152,400		31,750		1,30	4T-652	29	NTN
	152,400		33,338		1,04	4T-592	29	NTN

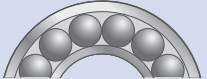

							 Brands
d	D	B	C	T	Kg	Reference	
	155,000		28,000		0,77	4T-JM720210	29 NTN
	155,000		35,500		1,02	4T-JHM318410	29 NTN
	157,000		34,000		0,87	4T-HM220110	29 NTN
	157,162		26,195		0,70	4T-52618	29 NTN
	158,775		15,875		0,49	4T-37625	29 NTN
	159,987		26,988		0,78	4T-LM522510	29 NTN
	160,000		32,000		0,97	4T-JHM720210	29 NTN
	160,000		44,450		1,67	4T-6525X	29 NTN
	160,338		16,670		0,40	4T-L624510	29 NTN
	161,925		26,988		0,83	4T-48120	29 NTN
	161,925		38,100		1,70	4T-752	29 NTN
	161,925		42,862		1,60	4T-6535	29 NTN
	165,000		26,500		0,83	4T-JM822010	29 NTN
	165,100		26,988		0,84	4T-56650	29 NTN
	168,275		26,988		1,04	4T-56662	29 NTN
	168,275		30,162		1,30	4T-672	29 NTN
	168,275		38,100		2,10	4T-753	29 NTN
	168,275		41,275		1,74	4T-832	29 NTN
	169,862		20,638		0,55	4T-L225810	29 NTN
	180,000		38,000		1,51	4T-JHM522610	29 NTN
	180,975		25,400		1,88	4T-68712	29 NTN
	180,975		38,100		2,00	4T-772	29 NTN
	182,562		33,338		1,20	4T-48220	29 NTN
	184,150		52,388		2,55	4T-HH421210	29 NTN
	190,500		33,338		1,16	4T-48320	29 NTN
	190,500		34,925		1,78	4T-71750	29 NTN
	190,500		44,450		2,69	4T-854	29 NTN
	190,500		46,038		2,20	4T-HH221410	29 NTN
	196,850		38,100		1,46	4T-67322	29 NTN
	200,000		34,925		2,37	4T-98788	29 NTN
	200,025		34,130		1,39	4T-48620	29 NTN
	203,200		38,100		2,06	4T-67320	29 NTN
	205,583		18,258		0,60	4T-L432310	29 NTN
	206,375		34,925		2,00	4T-792	29 NTN
	206,375		53,975		3,23	4T-930	29 NTN
	212,725		53,975		3,06	4T-HH224310	29 NTN
	212,725		53,975		4,60	4T-932	29 NTN
	214,000		90,488		8,41	4T-67790D	29 NTN
	214,312		39,688		2,50	4T-H924010	29 NTN
	215,900		34,925		1,95	4T-74850	29 NTN
	222,250		34,925		1,88	4T-M231610	29 NTN
	225,425		33,338		1,80	4T-46720	29 NTN
	227,012		23,020		0,90	4T-36920	29 NTN
	228,600		38,100		2,81	4T-HM926710	29 NTN
	228,625		44,450		3,13	4T-892	29 NTN
	230,000		31,000		1,30	4T-JHM534110	29 NTN
	234,950		49,212		4,05	4T-95925	29 NTN
	240,000		37,000		2,00	4T-JM734410	29 NTN
	247,650		38,100		2,50	4T-67720	29 NTN
	247,650		84,138		5,00	4T-67720D	29 NTN
	254,000		47,625		4,30	4T-99100	29 NTN
	254,000		61,912		6,04	4T-HH228310	29 NTN
	257,175		30,162		1,74	4T-LM739710	29 NTN
	259,974		61,912		7,28	4T-HH228318	29 NTN
	260,000		36,500		2,20	4T-JM738210	29 NTN
	260,350		41,275		2,86	4T-M236810	29 NTN
	261,142		21,433		1,07	4T-LL641110	29 NTN
	269,875		42,862		3,12	4T-M238810	29 NTN
	273,050		53,975		7,00	4T-HH926710	29 NTN
	282,575		36,512		2,81	4T-67920	29 NTN
	285,750		34,925		2,40	4T-LM742710	29 NTN
	288,925		47,625		4,49	4T-HM237510	29 NTN

								Brands
d	D	B	C	T	Kg	Reference		
	290,010		22,225		1,73	4T-543114	29	NTN
	300,000		51,000		5,37	4T-JHM840410	29	NTN
	307,975		66,675		8,69	HH234010	29	NTN
	311,150		65,088		8,60	E-H238110	29	NTN
	314,325		49,212		4,64	4T-M244210	29	NTN
	336,550		50,800		5,49	4T-M246910	29	NTN
	336,550		77,788		11,00	4T-H242610	29	NTN
	358,775		53,975		6,51	4T-M249710	29	NTN
	381,000		57,150		7,72	4T-M252310	29	NTN
	384,175		90,488		9,50	E-H247510	29	NTN
	384,175		90,488		16,90	4T-H247510	29	NTN
	447,675		68,262		12,80	E-HM259010	29	NTN
	457,098		47,625		9,39	4T-LM961511	29	NTN
	488,950		74,612		16,70	E-HM262710	29	NTN
	546,100		82,550		23,60	4T-HM266410	29	NTN



Classification by dimensions – Classement par dimensions
Klassifizierung nach Abmessungen – Classificazione per dimensione
Clasificación por dimensiones – Classificação por dimensões
Классификация по размерам – Klasyfikacja wg wymiarów



Spherical roller bearing



Pendelrollenlager



Rodamientos de rodillos a rótula



Сферические роликоподшипники



Roulements à rotule sur rouleaux



Cuscinetti orientabili a rulli



Rolamentos autocompensadores de rolos



Łożyska baryłkowe



d	D	B	Kg	Reference	?	Brands
25,000	52,000	18,000	0,18	22205EA	33	SNR
	52,000	18,000	0,18	22205EAKW33	33	SNR
	52,000	18,000	0,18	22205EAW33	33	SNR
	52,000	18,000	0,17	22205EG15W33	33	SNR
	52,000	18,000	0,18	22205EMKW33	33	SNR
	52,000	18,000	0,18	22205EMW33	33	SNR
	62,000	17,000	0,26	21305V	33	SNR
	62,000	17,000	0,26	21305VK	33	SNR
30,000	62,000	20,000	0,29	22206EA	33	SNR
	62,000	20,000	0,28	22206EAKW33	33	SNR
	62,000	20,000	0,28	22206EAW33	33	SNR
	62,000	20,000	0,27	22206EG15KW33	33	SNR
	62,000	20,000	0,27	22206EG15W33	33	SNR
	62,000	20,000	0,28	22206EMKW33	33	SNR
	62,000	20,000	0,29	22206EMW33	33	SNR
	72,000	19,000	0,39	21306V	33	SNR
72,000	19,000	0,39	21306VK	33	SNR	
35,000	72,000	23,000	0,44	22207EAKW33	33	SNR
	72,000	23,000	0,45	22207EAW33	33	SNR
	72,000	23,000	0,42	22207EG15KW33	33	SNR
	72,000	23,000	0,43	22207EG15W33	33	SNR
	72,000	23,000	0,45	22207EMKW33	33	SNR
	72,000	23,000	0,46	22207EMW33	33	SNR
	80,000	21,000	0,53	21307V	33	SNR
	80,000	21,000	0,52	21307VK	33	SNR
40,000	80,000	18,000	0,37	20208EG15	33	SNR
	80,000	23,000	0,53	22208EAKW33	33	SNR
	80,000	23,000	0,53	22208EAW33	33	SNR
	80,000	23,000	0,52	22208EG15W33	33	SNR
	80,000	23,000	0,55	22208EM	33	SNR
	80,000	23,000	0,57	22208EMKW33	33	SNR
	80,000	23,000	0,54	22208EMW33	33	SNR
	90,000	23,000	0,73	21308V	33	SNR
	90,000	23,000	0,71	21308VK	33	SNR
	90,000	33,000	1,01	22308EAKW33	33	SNR
	90,000	33,000	1,03	22308EAW33	33	SNR
	90,000	33,000	1,04	22308EF800	33	SNR
	90,000	33,000	0,97	22308EG15KW33	33	SNR
	90,000	33,000	0,99	22308EG15W33	33	SNR
90,000	33,000	1,05	22308EMW33	33	SNR	
45,000	85,000	23,000	0,57	22209EAKW33	33	SNR
	85,000	23,000	0,58	22209EAW33	33	SNR
	85,000	23,000	0,56	22209EG15W33	33	SNR
	85,000	23,000	0,60	22209EM	33	SNR
	85,000	23,000	0,58	22209EMKW33	33	SNR
	85,000	23,000	0,59	22209EMW33	33	SNR
	100,000	25,000	0,97	21309V	33	SNR
	100,000	25,000	0,96	21309VK	33	SNR
	100,000	36,000	1,35	22309EAKW33	33	SNR
	100,000	36,000	1,38	22309EAW33	33	SNR
	100,000	36,000	1,41	22309EF800	33	SNR
	100,000	36,000	1,42	22309EF801	33	SNR
	100,000	36,000	1,30	22309EG15KW33	33	SNR
	100,000	36,000	1,33	22309EG15W33	33	SNR
	100,000	36,000	1,37	22309EKF800	33	SNR
	100,000	36,000	1,41	22309EM	33	SNR
	100,000	36,000	1,40	22309EMW33	33	SNR

d	D	B	Kg	Reference	?	Brands
50,000	90,000	23,000	0,62	22210EAKW33	33	SNR
	90,000	23,000	0,62	22210EAW33	33	SNR
	90,000	23,000	2,80	22210EG15KW33	33	SNR
	90,000	23,000	0,61	22210EG15W33	33	SNR
	90,000	23,000	0,63	22210EMKW33	33	SNR
	90,000	23,000	0,64	22210EMW33	33	SNR
	110,000	27,000	1,28	21310V	33	SNR
	110,000	27,000	1,26	21310VK	33	SNR
	110,000	40,000	1,80	22310EAKW33	33	SNR
	110,000	40,000	1,84	22310EAW33	33	SNR
	110,000	40,000	1,87	22310EF800	33	SNR
	110,000	40,000	1,87	22310EF801	33	SNR
	110,000	40,000	1,72	22310EG15KW33	33	SNR
	110,000	40,000	1,77	22310EG15W33	33	SNR
	110,000	40,000	1,83	22310EKF800	33	SNR
	110,000	40,000	1,82	22310EMKW33	33	SNR
	110,000	40,000	1,87	22310EMW33	33	SNR
	55,000	95,000	37,000	1,13	2P1111	33
100,000		25,000	0,83	22211EA	33	SNR
100,000		25,000	0,83	22211EAKW33	33	SNR
100,000		25,000	0,84	22211EAW33	33	SNR
100,000		25,000	0,80	22211EG15KW33	33	SNR
100,000		25,000	0,84	22211EMKW33	33	SNR
100,000		25,000	0,86	22211EMW33	33	SNR
120,000		29,000	1,63	21311V	33	SNR
120,000		29,000	1,60	21311VK	33	SNR
120,000		43,000	2,40	22311BVS1	33	NTN
120,000		43,000	2,30	22311BVS2	33	NTN
120,000		43,000	2,28	22311EAKW33	33	SNR
120,000		43,000	2,30	22311EAW33	33	SNR
120,000		43,000	2,39	22311EF800	33	SNR
120,000		43,000	2,39	22311EF801	33	SNR
120,000		43,000	2,23	22311EG15KW33	33	SNR
120,000		43,000	2,28	22311EG15W33	33	SNR
120,000		43,000	2,32	22311EKF800	33	SNR
120,000	43,000	2,34	22311EKF801	33	SNR	
120,000	43,000	2,33	22311EMKW33	33	SNR	
120,000	43,000	2,38	22311EMW33	33	SNR	
120,000	43,000	2,14	2P1109LL	33	NTN	
60,000	110,000	28,000	1,14	22212EAKW33	33	SNR
	110,000	28,000	1,16	22212EAW33	33	SNR
	110,000	28,000	1,13	22212EG15W33	33	SNR
	110,000	28,000	1,16	22212EMKW33	33	SNR
	110,000	28,000	1,17	22212EMW33	33	SNR
	130,000	31,000	1,98	21312V	33	SNR
	130,000	31,000	1,96	21312VK	33	SNR
	130,000	42,000	2,74	29412	39	NTN
	130,000	42,000	2,47	29412E	39	SNR
	130,000	46,000	3,06	22312BVS1	33	NTN
	130,000	46,000	3,00	22312BVS2	33	NTN
	130,000	46,000	2,80	22312EAKW33	33	SNR
	130,000	46,000	2,87	22312EAW33	33	SNR
	130,000	46,000	2,95	22312EF800	33	SNR
	130,000	46,000	2,95	22312EF801	33	SNR
	130,000	46,000	2,70	22312EG15KW33	33	SNR
	130,000	46,000	2,77	22312EG15W33	33	SNR
	130,000	46,000	2,89	22312EKF800	33	SNR
130,000	46,000	2,97	22312EM	33	SNR	
130,000	46,000	2,88	22312EMKW33	33	SNR	
130,000	46,000	2,95	22312EMW33	33	SNR	

								Brands	
d	D	B	Kg	Reference					
65,000	120,000	31,000	1,56	22213EA	33	SNR			
	120,000	31,000	1,51	22213EAKW33	33	SNR			
	120,000	31,000	1,55	22213EAW33	33	SNR			
	120,000	31,000	1,39	22213EG15KW33	33	SNR			
	120,000	31,000	1,45	22213EG15W33	33	SNR			
	120,000	31,000	1,54	22213EMKW33	33	SNR			
	120,000	31,000	1,57	22213EMW33	33	SNR			
	140,000	33,000	2,44	21313V	33	SNR			
	140,000	33,000	2,39	21313VK	33	SNR			
	140,000	45,000	3,40	29413	39	NTN			
	140,000	45,000	3,26	29413E	39	SNR			
	140,000	48,000	3,68	22313BVS1	33	NTN			
	140,000	48,000	3,65	22313BVS2	33	NTN			
	140,000	48,000	3,51	22313EA	33	SNR			
	140,000	48,000	3,40	22313EAKW33	33	SNR			
	140,000	48,000	3,48	22313EAW33	33	SNR			
	140,000	48,000	3,55	22313EF800	33	SNR			
	140,000	48,000	3,53	22313EF801	33	SNR			
	140,000	48,000	3,32	22313EG15W33	33	SNR			
	140,000	48,000	3,46	22313EKF800	33	SNR			
140,000	48,000	3,54	22313EMW33	33	SNR				
70,000	125,000	31,000	1,57	22214EAKW33	33	SNR			
	125,000	31,000	1,63	22214EAW33	33	SNR			
	125,000	31,000	1,45	22214EG15KW33	33	SNR			
	125,000	31,000	1,52	22214EG15W33	33	SNR			
	125,000	31,000	1,64	22214EMKW33	33	SNR			
	125,000	31,000	1,67	22214EMW33	33	SNR			
	150,000	35,000	3,01	21314V	33	SNR			
	150,000	35,000	2,97	21314VK	33	SNR			
	150,000	48,000	4,14	29414	39	NTN			
	150,000	48,000	3,89	29414E	39	SNR			
	150,000	51,000	4,19	22314EAKW33	33	SNR			
	150,000	51,000	4,29	22314EAW33	33	SNR			
	150,000	51,000	4,41	22314EF800	33	SNR			
	150,000	51,000	4,38	22314EF801	33	SNR			
	150,000	51,000	4,00	22314EG15KW33	33	SNR			
	150,000	51,000	4,13	22314EG15W33	33	SNR			
	150,000	51,000	4,29	22314EKF800	33	SNR			
	150,000	51,000	4,31	22314EMKW33	33	SNR			
	150,000	51,000	4,39	22314EMW33	33	SNR			
	150,000	51,000	4,37	22314UAVS2	33	NTN			
150,000	51,000	4,11	2P1410LL	33	NTN				
155,000	58,000	5,44	2P1403	33	NTN				
75,000	130,000	31,000	1,66	22215EAKW33	33	SNR			
	130,000	31,000	1,70	22215EAW33	33	SNR			
	130,000	31,000	1,53	22215EG15KW33	33	SNR			
	130,000	31,000	1,62	22215EG15W33	33	SNR			
	130,000	31,000	1,71	22215EMKW33	33	SNR			
	130,000	31,000	1,75	22215EMW33	33	SNR			
	160,000	37,000	3,59	21315V	33	SNR			
	160,000	37,000	3,54	21315VK	33	SNR			
	160,000	51,000	5,01	29415	39	NTN			
	160,000	51,000	4,77	29415E	39	SNR			
	160,000	55,000	5,10	22315EAKW33	33	SNR			
	160,000	55,000	5,21	22315EAW33	33	SNR			
	160,000	55,000	5,35	22315EF800	33	SNR			
	160,000	55,000	5,34	22315EF801	33	SNR			
	160,000	55,000	4,89	22315EG15KW33	33	SNR			
	160,000	55,000	5,01	22315EG15W33	33	SNR			
	160,000	55,000	5,50	22315EKF800	33	SNR			

								Brands	
d	D	B	Kg	Reference					
75,000	160,000	55,000	5,53	22315EM	33	SNR			
	160,000	55,000	5,24	22315EMKW33	33	SNR			
	160,000	55,000	5,35	22315EMW33	33	SNR			
	160,000	55,000	5,47	22315UAVS2	33	NTN			
80,000	140,000	33,000	2,07	22216EAKW33	33	SNR			
	140,000	33,000	2,11	22216EAW33	33	SNR			
	140,000	33,000	2,15	22216EF800	33	SNR			
	140,000	33,000	1,96	22216EG15KW33	33	SNR			
	140,000	33,000	2,00	22216EG15W33	33	SNR			
	140,000	33,000	2,11	22216EMKW33	33	SNR			
	140,000	33,000	2,16	22216EMW33	33	SNR			
	170,000	39,000	4,24	21316V	33	SNR			
	170,000	39,000	4,19	21316VK	33	SNR			
	170,000	54,000	6,04	29416	39	NTN			
	170,000	54,000	5,68	29416E	39	SNR			
	170,000	58,000	6,03	22316EAKW33	33	SNR			
	170,000	58,000	6,17	22316EAW33	33	SNR			
	170,000	58,000	6,35	22316EF800	33	SNR			
	170,000	58,000	6,38	22316EF801	33	SNR			
	170,000	58,000	5,81	22316EG15KW33	33	SNR			
	170,000	58,000	5,92	22316EG15W33	33	SNR			
	170,000	58,000	6,24	22316EKF800	33	SNR			
	170,000	58,000	6,29	22316EMK	33	SNR			
	170,000	58,000	6,25	22316EMKW33	33	SNR			
170,000	58,000	6,38	22316EMW33	33	SNR				
170,000	58,000	6,32	22316UAVS2	33	NTN				
170,000	58,000	6,46	2P1608LL	33	NTN				
85,000	150,000	36,000	2,60	22217EAKW33	33	SNR			
	150,000	36,000	2,65	22217EAW33	33	SNR			
	150,000	36,000	2,47	22217EG15KW33	33	SNR			
	150,000	36,000	2,09	22217EG15W33	33	SNR			
	150,000	36,000	2,69	22217EMKW33	33	SNR			
	150,000	36,000	2,75	22217EMW33	33	SNR			
	150,000	39,000	2,88	29317	39	NTN			
	180,000	41,000	5,28	21317VM	33	SNR			
	180,000	41,000	5,20	21317VMK	33	SNR			
	180,000	58,000	7,10	29417	39	NTN			
	180,000	58,000	6,67	29417E	39	SNR			
	180,000	60,000	7,06	22317EAKW33	33	SNR			
	180,000	60,000	7,22	22317EAW33	33	SNR			
	180,000	60,000	7,39	22317EF800	33	SNR			
	180,000	60,000	7,39	22317EF801	33	SNR			
	180,000	60,000	7,26	22317EKF800	33	SNR			
	180,000	60,000	7,20	22317EMKW33	33	SNR			
	180,000	60,000	7,41	22317EMW33	33	SNR			
	180,000	60,000	7,32	22317UAVS2	33	NTN			
	90,000	155,000	39,000	3,02	29318	39	NTN		
160,000		40,000	3,30	22218EAKW33	33	SNR			
160,000		40,000	3,38	22218EAW33	33	SNR			
160,000		40,000	3,28	22218EF800	33	SNR			
160,000		40,000	3,19	22218EG15KW33	33	SNR			
160,000		40,000	3,27	22218EG15W33	33	SNR			
160,000		40,000	3,42	22218EMKW33	33	SNR			
160,000		40,000	3,50	22218EMW33	33	SNR			
160,000		52,400	4,33	23218EAK	33	SNR			
160,000		52,400	4,31	23218EAKW33	33	SNR			
160,000		52,400	4,43	23218EAW33	33	SNR			
160,000		52,400	4,38	23218EMKW33	33	SNR			
160,000		52,400	4,51	23218EMW33	33	SNR			

d	D	B	Kg	Reference			Brands	
90,000	160,000	69,000	5,20	2P1818	33	NTN		
	190,000	43,000	6,15	21318VM	33	SNR		
	190,000	43,000	6,06	21318VMK	33	SNR		
	190,000	60,000	8,30	29418	39	NTN		
	190,000	60,000	7,77	29418E	39	SNR		
	190,000	64,000	8,28	22318EAKW33	33	SNR		
	190,000	64,000	8,42	22318EANW33	33	SNR		
	190,000	64,000	8,44	22318EAW33	33	SNR		
	190,000	64,000	8,62	22318EF800	33	SNR		
	190,000	64,000	8,67	22318EF801	33	SNR		
	190,000	64,000	8,50	22318EF800	33	SNR		
	190,000	64,000	8,50	22318EF801	33	SNR		
	190,000	64,000	8,53	22318EMK	33	SNR		
	190,000	64,000	8,51	22318EMKW33	33	SNR		
	190,000	64,000	8,68	22318EMW33	33	SNR		
	190,000	64,000	8,66	22318UAVS2	33	NTN		
	190,000	64,000	8,66	MX-22318UAVS2	33	NTN		
	190,000	73,000	10,10	23318VS2	33	NTN		
	95,000	170,000	43,000	3,99	22219EA	33	SNR	
		170,000	43,000	3,93	22219EAKW33	33	SNR	
170,000		43,000	4,03	22219EAW33	33	SNR		
170,000		43,000	4,06	22219EMKW33	33	SNR		
170,000		43,000	4,16	22219EMW33	33	SNR		
200,000		67,000	9,72	22319EAKW33	33	SNR		
200,000		67,000	9,95	22319EAW33	33	SNR		
200,000		67,000	10,18	22319EF800	33	SNR		
200,000		67,000	9,98	22319EMKW33	33	SNR		
200,000		67,000	10,19	22319EMW33	33	SNR		
200,000		67,000	10,00	22319UAVS1	33	NTN		
200,000		67,000	10,40	22319UAVS2	33	NTN		
100,000		150,000	50,000	2,98	24020EAW33	33	SNR	
		165,000	52,000	3,11	23120EAKW33	33	SNR	
	165,000	52,000	4,43	23120EAW33	33	SNR		
	165,000	52,000	4,18	23120EG15KW33	33	SNR		
	165,000	52,000	4,32	23120EG15W33	33	SNR		
	165,000	52,000	4,37	23120EMKW33	33	SNR		
	165,000	52,000	4,67	23120EMW33	33	SNR		
	170,000	42,000	3,87	29320	39	NTN		
	170,000	42,000	3,65	29320E	39	SNR		
	170,000	65,000	6,11	2P2014	33	NTN		
	180,000	46,000	5,01	22220EA	33	SNR		
	180,000	46,000	4,84	22220EAKW33	33	SNR		
	180,000	46,000	4,96	22220EAW33	33	SNR		
	180,000	46,000	5,08	22220EF800	33	SNR		
	180,000	46,000	4,71	22220EG15KW33	33	SNR		
	180,000	46,000	4,80	22220EG15W33	33	SNR		
	180,000	46,000	5,02	22220EMKW33	33	SNR		
	180,000	46,000	5,11	22220EMW33	33	SNR		
	180,000	60,300	6,32	23220EAKW33	33	SNR		
	180,000	60,300	6,50	23220EAW33	33	SNR		
	180,000	60,300	6,42	23220EMKW33	33	SNR		
	180,000	60,300	6,60	23220EMW33	33	SNR		
	210,000	67,000	11,40	29420	39	NTN		
	210,000	67,000	10,80	29420E	39	SNR		
	215,000	73,000	12,37	22320EAKW33	33	SNR		
	215,000	73,000	12,61	22320EAW33	33	SNR		
	215,000	73,000	13,03	22320EF800	33	SNR		
	215,000	73,000	12,78	22320EKF800	33	SNR		
	215,000	73,000	12,79	22320EMKW33	33	SNR		
	215,000	73,000	13,06	22320EMW33	33	SNR		

d	D	B	Kg	Reference			Brands
100,000	215,000	73,000	12,90	22320UAVS2	33	NTN	
	215,000	73,000	12,70	MX-22320UAVS2	33	NTN	
110,000	170,000	45,000	3,59	23022EAKW33	33	SNR	
	170,000	45,000	3,70	23022EAW33	33	SNR	
	170,000	45,000	3,61	23022EMKW33	33	SNR	
	170,000	45,000	3,73	23022EMW33	33	SNR	
	170,000	60,000	4,81	24022EAW33	33	SNR	
	180,000	56,000	5,41	23122EAKW33	33	SNR	
	180,000	56,000	5,58	23122EAW33	33	SNR	
	180,000	56,000	6,86	23122EMKW33	33	SNR	
	180,000	56,000	5,61	23122EMW33	33	SNR	
	180,000	69,000	6,65	24122EAW33	33	SNR	
	180,000	69,000	6,68	2P2212L	33	NTN	
	180,000	82,000	7,97	2P2206	33	NTN	
	186,000	154,000	17,25	MX-RE2224V	33	NTN	
	190,000	48,000	5,70	29322	39	NTN	
	190,000	48,000	5,40	29322E	39	SNR	
	200,000	53,000	6,99	22222EAKW33	33	SNR	
	200,000	53,000	7,12	22222EAW33	33	SNR	
	200,000	53,000	6,80	22222EG15KW33	33	SNR	
	200,000	53,000	6,80	22222EG15W33	33	SNR	
	200,000	53,000	7,18	22222EMKW33	33	SNR	
	200,000	53,000	7,35	22222EMW33	33	SNR	
	200,000	69,800	9,11	23222EAKW33	33	SNR	
	200,000	69,800	9,39	23222EAW33	33	SNR	
	200,000	69,800	9,26	23222EMKW33	33	SNR	
	200,000	69,800	9,52	23222EMW33	33	SNR	
	230,000	73,000	14,90	29422	39	NTN	
	230,000	73,000	17,50	29422E	39	SNR	
	240,000	80,000	16,81	22322EAKW33	33	SNR	
	240,000	80,000	17,10	22322EAW33	33	SNR	
	240,000	80,000	17,73	22322EF800	33	SNR	
	240,000	80,000	17,85	22322EF803	33	SNR	
	240,000	80,000	17,39	22322EKF800	33	SNR	
	240,000	80,000	17,37	22322EMKW33	33	SNR	
	240,000	80,000	17,76	22322EMW33	33	SNR	
240,000	80,000	18,10	22322UAVS1	33	NTN		
240,000	80,000	18,12	22322UAVS2	33	NTN		
120,000	180,000	46,000	3,95	23024EAKW33	33	SNR	
	180,000	46,000	4,07	23024EAW33	33	SNR	
	180,000	46,000	3,98	23024EMKW33	33	SNR	
	180,000	46,000	505,59	23024EMW33	33	SNR	
	180,000	60,000	5,07	24024EAK30W33	33	SNR	
	180,000	60,000	5,16	24024EAW33	33	SNR	
	200,000	62,000	7,55	23124EAKW33	33	SNR	
	200,000	62,000	7,79	23124EAW33	33	SNR	
	200,000	62,000	7,61	23124EMKW33	33	SNR	
	200,000	62,000	7,88	23124EMW33	33	SNR	
	200,000	80,000	9,73	24124EAK30W33	33	SNR	
	200,000	80,000	9,93	24124EAW33	33	SNR	
	210,000	54,000	7,80	29324	39	NTN	
	210,000	54,000	7,24	29324E	39	SNR	
	215,000	58,000	8,70	22224EAKW33	33	SNR	
	215,000	58,000	8,92	22224EAW33	33	SNR	
	215,000	58,000	8,96	22224EMKW33	33	SNR	
	215,000	58,000	9,16	22224EMW33	33	SNR	
	215,000	76,000	11,25	23224EAKW33	33	SNR	
	215,000	76,000	11,64	23224EAW33	33	SNR	
	215,000	76,000	11,45	23224EMKW33	33	SNR	
	215,000	76,000	11,80	23224EMW33	33	SNR	



d	D	B	Kg	Reference						
120,000	250,000	78,000	18,40	29424	39	NTN				
	250,000	78,000	17,50	29424E	39	SNR				
	260,000	86,000	22,23	22324EAKW33	33	SNR				
	260,000	86,000	22,40	22324EAW33	33	SNR				
	260,000	86,000	23,00	22324EF800	33	SNR				
	260,000	86,000	22,53	22324EKF800	33	SNR				
	260,000	86,000	23,21	22324EM	33	SNR				
	260,000	86,000	22,75	22324EMK	33	SNR				
	260,000	86,000	22,52	22324EMKW33	33	SNR				
	260,000	86,000	22,87	22324EMW33	33	SNR				
	260,000	86,000	21,90	22324UAVS2	33	NTN				
	260,000	86,000	21,90	MX-22324UAVS2	33	NTN				
	260,000	106,000	28,10	23324VS2	33	NTN				
	130,000	200,000	52,000	5,76	23026EAKW33	33	SNR			
		200,000	52,000	5,93	23026EAW33	33	SNR			
200,000		52,000	5,82	23026EMKW33	33	SNR				
200,000		52,000	6,00	23026EMW33	33	SNR				
200,000		69,000	7,41	24026EAK30W33	33	SNR				
200,000		69,000	7,52	24026EAW33	33	SNR				
210,000		64,000	8,26	23126EAKW33	33	SNR				
210,000		64,000	8,59	23126EAW33	33	SNR				
210,000		64,000	8,35	23126EMKW33	33	SNR				
210,000		64,000	8,63	23126EMW33	33	SNR				
210,000		80,000	10,21	24126EAK30W33	33	SNR				
210,000		80,000	10,34	24126EAW33	33	SNR				
215,000		172,000	21,00	2PE2606	33	NTN				
225,000		58,000	9,65	29326	39	NTN				
225,000		58,000	8,98	29326E	39	SNR				
230,000		64,000	10,74	22226EAKW33	33	SNR				
230,000		64,000	11,00	22226EAW33	33	SNR				
230,000		64,000	10,90	22226EMKW33	33	SNR				
230,000		64,000	11,30	22226EMW33	33	SNR				
230,000		80,000	13,33	23226EAKW33	33	SNR				
230,000		80,000	13,76	23226EAW33	33	SNR				
230,000		80,000	13,56	23226EMKW33	33	SNR				
230,000		80,000	14,29	23226EMW33	33	SNR				
230,000		89,000	15,50	2P2635LLS	33	NTN				
270,000		85,000	23,50	29426	39	NTN				
270,000		85,000	27,00	29426E	39	SNR				
280,000		93,000	30,30	22326EAKW33	33	SNR				
280,000		93,000	30,80	22326EAW33	33	SNR				
280,000		93,000	31,60	22326EF800	33	SNR				
280,000		93,000	31,20	22326EKF800	33	SNR				
280,000		93,000	29,85	22326EMKW33	33	SNR				
280,000		93,000	31,64	22326EMW33	33	SNR				
280,000		93,000	28,32	22326UAVS1	33	NTN				
280,000	93,000	28,32	22326UAVS2	33	NTN					
140,000	210,000	53,000	6,20	23028EAKW33	33	SNR				
	210,000	53,000	6,41	23028EAW33	33	SNR				
	210,000	53,000	6,29	23028EMKW33	33	SNR				
	210,000	53,000	6,48	23028EMW33	33	SNR				
	210,000	69,000	8,03	24028EAK30W33	33	SNR				
	210,000	69,000	8,15	24028EAW33	33	SNR				
	225,000	68,000	10,00	23128EAKW33	33	SNR				
	225,000	68,000	10,33	23128EAW33	33	SNR				
	225,000	68,000	10,09	23128EMKW33	33	SNR				
	225,000	68,000	10,41	23128EMW33	33	SNR				
	225,000	85,000	12,37	24128EAK30W33	33	SNR				
	225,000	85,000	12,56	24128EAW33	33	SNR				
	240,000	60,000	11,22	29328	39	NTN				

d	D	B	Kg	Reference					
140,000	240,000	60,000	10,40	29328E	39	SNR			
	250,000	68,000	13,60	22228EAKW33	33	SNR			
	250,000	68,000	13,92	22228EAW33	33	SNR			
	250,000	68,000	14,07	22228EMKW33	33	SNR			
	250,000	68,000	14,42	22228EMW33	33	SNR			
	250,000	88,000	17,48	23228EAKW33	33	SNR			
	250,000	88,000	18,04	23228EAW33	33	SNR			
	250,000	88,000	17,89	23228EMKW33	33	SNR			
	250,000	88,000	18,45	23228EMW33	33	SNR			
	280,000	85,000	22,90	29428	39	NTN			
	280,000	85,000	28,39	29428E	39	SNR			
	300,000	102,000	35,60	22328EAKW33	33	SNR			
	300,000	102,000	37,33	22328EAW33	33	SNR			
	300,000	102,000	41,00	22328EF800	33	SNR			
	300,000	102,000	40,60	22328EKF800	33	SNR			
	300,000	102,000	34,72	22328EMKW33	33	SNR			
	300,000	102,000	38,67	22328EMW33	33	SNR			
	300,000	102,000	35,52	22328UAVS1	33	NTN			
	300,000	102,000	36,10	22328UAVS2	33	NTN			
	300,000	102,000	34,40	MX-22328UAVS2	33	NTN			
	300,000	118,000	39,80	23328VS1	33	NTN			
	300,000	118,000	38,60	23328VS2	33	NTN			
	145,000	202,000	196,000	19,30	MX-RE2906V	33	NTN		
150,000	215,000	39,000	4,44	29230	39	NTN			
	225,000	56,000	7,53	23030EAKW33	33	SNR			
	225,000	56,000	7,77	23030EAW33	33	SNR			
	225,000	56,000	7,91	23030EM	33	SNR			
	225,000	56,000	7,64	23030EMKW33	33	SNR			
	225,000	56,000	7,86	23030EMW33	33	SNR			
	225,000	56,000	7,00	2P3016	33	NTN			
	225,000	75,000	9,90	24030EAK30W33	33	SNR			
	225,000	75,000	10,14	24030EAW33	33	SNR			
	250,000	60,000	11,70	29330	39	NTN			
	250,000	60,000	16,10	29330E	39	SNR			
	250,000	80,000	15,30	23130EAKW33	33	SNR			
	250,000	80,000	15,78	23130EAW33	33	SNR			
	250,000	80,000	15,45	23130EMKW33	33	SNR			
	250,000	80,000	15,97	23130EMW33	33	SNR			
	250,000	100,000	18,60	24130EAK30W33	33	SNR			
	250,000	100,000	19,21	24130EAW33	33	SNR			
	250,000	100,000	18,30	2P3019	33	NTN			
	250,000	100,000	18,30	2P3032L	33	NTN			
	270,000	73,000	17,35	22230EAKW33	33	SNR			
	270,000	73,000	17,75	22230EAW33	33	SNR			
	270,000	73,000	17,89	22230EMKW33	33	SNR			
	270,000	73,000	18,28	22230EMW33	33	SNR			
	270,000	96,000	22,78	23230EAKW33	33	SNR			
	270,000	96,000	23,51	23230EAW33	33	SNR			
	270,000	96,000	23,12	23230EMKW33	33	SNR			
	270,000	96,000	23,83	23230EMW33	33	SNR			
300,000	90,000	30,30	29430	39	NTN				
300,000	90,000	40,00	29430E	39	SNR				
320,000	108,000	46,38	22330EF800	33	SNR				
320,000	108,000	47,10	22330EKF800	33	SNR				
320,000	108,000	41,40	22330EKW33	33	SNR				
320,000	108,000	45,90	22330EMKW33	33	SNR				
320,000	108,000	45,57	22330EMW33	33	SNR				
320,000	108,000	43,40	22330UAVS1	33	NTN				
320,000	108,000	43,40	22330UAVS2	33	NTN				
320,000	108,000	41,30	MX-22330UAVS2	33	NTN				

								Brands		
d	D	B	Kg	Reference						
160,000	220,000	45,000	5,50	23932	33	NTN				
	225,000	39,000	4,81	29232	39	NTN				
	240,000	60,000	9,00	23032EAKW33	33	SNR				
	240,000	60,000	9,40	23032EAW33	33	SNR				
	240,000	60,000	9,25	23032EMKW33	33	SNR				
	240,000	60,000	9,49	23032EMW33	33	SNR				
	240,000	80,000	11,77	24032EAK30W33	33	SNR				
	240,000	80,000	11,96	24032EAW33	33	SNR				
	270,000	67,000	15,70	29332	39	NTN				
	270,000	67,000	14,40	29332E	39	SNR				
	270,000	86,000	19,44	23132EAKW33	33	SNR				
	270,000	86,000	20,22	23132EAW33	33	SNR				
	270,000	86,000	19,79	23132EMKW33	33	SNR				
	270,000	86,000	20,36	23132EMW33	33	SNR				
	270,000	109,000	24,36	24132EAK30W33	33	SNR				
	270,000	109,000	24,80	24132EAW33	33	SNR				
	290,000	80,000	21,93	22232EAKW33	33	SNR				
	290,000	80,000	22,45	22232EAW33	33	SNR				
	290,000	80,000	22,85	22232EMKW33	33	SNR				
	290,000	80,000	23,21	22232EMW33	33	SNR				
	290,000	104,000	31,15	23232EAKW33	33	SNR				
	290,000	104,000	33,90	23232EAW33	33	SNR				
	290,000	104,000	32,45	23232EMKW33	33	SNR				
	290,000	104,000	34,40	23232EMW33	33	SNR				
	320,000	95,000	36,60	29432	39	NTN-SNR				
	340,000	114,000	56,00	22332EF800	33	SNR				
	340,000	114,000	55,80	22332EF802	33	SNR				
	340,000	114,000	54,50	22332EF800	33	SNR				
	340,000	114,000	55,70	22332EMKW33	33	SNR				
	340,000	114,000	54,13	22332EMW33	33	SNR				
	340,000	114,000	51,12	22332UAVS1	33	NTN				
	340,000	114,000	54,00	22332UAVS2	33	NTN				
	340,000	114,000	49,20	MX-22332UAVS2	33	NTN				
	340,000	136,000	58,60	23332VS1	33	NTN				
	340,000	136,000	58,00	23332VS2	33	NTN				
	165,000	275,000	194,000	45,00	2PE3303	33	NTN			
	170,000	230,000	45,000	5,34	23934	33	NTN			
		240,000	42,000	5,94	29234	39	NTN			
		260,000	67,000	12,45	23034EAKW33	33	SNR			
		260,000	67,000	12,85	23034EAW33	33	SNR			
260,000		67,000	12,63	23034EMKW33	33	SNR				
260,000		67,000	13,00	23034EMW33	33	SNR				
260,000		90,000	16,20	24034EAK30W33	33	SNR				
260,000		90,000	17,00	24034EAW33	33	SNR				
280,000		67,000	16,50	29334	39	NTN				
280,000		67,000	15,10	29334E	39	SNR				
280,000		88,000	20,97	23134EAKW33	33	SNR				
280,000		88,000	21,66	23134EAW33	33	SNR				
280,000		88,000	21,15	23134EMKW33	33	SNR				
280,000		88,000	21,84	23134EMW33	33	SNR				
280,000		88,000	19,40	2P3411LLK	33	NTN				
280,000		109,000	29,10	24134EAK30W33	33	SNR				
280,000		109,000	32,80	24134EAW33	33	SNR				
310,000		86,000	31,85	22234EMKW33	33	SNR				
310,000		86,000	32,75	22234EMW33	33	SNR				
310,000		110,000	36,12	23234EMKW33	33	SNR				
310,000		110,000	26,78	23234EMW33	33	SNR				
340,000		103,000	44,70	29434	39	NTN-SNR				
360,000		120,000	72,00	22334EF800	33	SNR				
360,000		120,000	70,00	22334EF802	33	SNR				

								Brands		
d	D	B	Kg	Reference						
170,000	360,000	120,000	59,55	22334EKF800	33	SNR				
	360,000	120,000	66,00	22334EMKW33	33	SNR				
	360,000	120,000	67,00	22334EMW33	33	SNR				
	360,000	120,000	60,62	22334UAVS2	33	NTN				
180,000	250,000	42,000	6,24	29236	39	NTN				
	250,000	52,000	7,80	23936	33	NTN				
	280,000	74,000	16,37	23036EAKW33	33	SNR				
	280,000	74,000	16,79	23036EAW33	33	SNR				
	280,000	74,000	16,55	23036EMKW33	33	SNR				
	280,000	74,000	17,02	23036EMW33	33	SNR				
	280,000	100,000	25,33	24036EAK30W33	33	SNR				
	280,000	100,000	23,74	24036EAW33	33	SNR				
	280,000	100,000	24,00	24036EAW34	33	SNR				
	290,000	169,000	43,50	MX-RE3621V	33	NTN				
	300,000	73,000	21,00	29336	39	NTN				
	300,000	73,000	26,10	29336E	39	SNR				
	300,000	96,000	29,81	23136EAKW33	33	SNR				
	300,000	96,000	31,20	23136EAW33	33	SNR				
	300,000	96,000	30,50	23136EMKW33	33	SNR				
	300,000	96,000	31,50	23136EMW33	33	SNR				
	300,000	118,000	33,40	24136EAK30W33	33	SNR				
	300,000	118,000	36,95	24136EAW33	33	SNR				
	320,000	86,000	32,57	22236EMKW33	33	SNR				
	320,000	86,000	31,98	22236EMW33	33	SNR				
	320,000	112,000	30,00	23236EMKW33	33	SNR				
	320,000	112,000	39,81	23236EMW33	33	SNR				
	360,000	109,000	52,80	29436	39	NTN-SNR				
	380,000	126,000	72,20	22336EMKW33	33	SNR				
	380,000	126,000	72,84	22336EMW33	33	SNR				
	380,000	126,000	67,60	22336UAVS1	33	NTN				
	380,000	126,000	71,40	22336UAVS2	33	NTN				
190,000	260,000	52,000	8,60	23938	33	NTN				
	260,000	52,000	8,34	23938K	33	NTN				
	270,000	48,000	8,67	29238	39	NTN				
	290,000	75,000	17,31	23038EAKW33	33	SNR				
	290,000	75,000	17,93	23038EAW33	33	SNR				
	290,000	75,000	17,60	23038EMKW33	33	SNR				
	290,000	75,000	18,17	23038EMW33	33	SNR				
	290,000	100,000	25,90	24038EAK30W33	33	SNR				
	290,000	100,000	26,35	24038EMW33	33	SNR				
	290,000	150,000	35,00	2PE3801	33	NTN				
	320,000	78,000	25,80	29338	39	NTN				
	320,000	78,000	33,50	29338E	39	SNR				
	320,000	104,000	37,30	23138EMKW33	33	SNR				
	320,000	104,000	29,53	23138EMW33	33	SNR				
	320,000	128,000	43,90	24138EAK30W33	33	SNR				
	320,000	128,000	44,50	24138EAW33	33	SNR				
	340,000	92,000	37,00	22238EMKW33	33	SNR				
	340,000	92,000	36,65	22238EMW33	33	SNR				
	340,000	120,000	49,03	23238EMKW33	33	SNR				
	340,000	120,000	36,25	23238EMW33	33	SNR				
	380,000	115,000	62,00	29438	39	NTN-SNR				
	400,000	132,000	81,00	22338B	33	NTN				
	400,000	132,000	79,30	22338BK	33	NTN				
	400,000	132,000	85,30	22338EMKW33	33	SNR				
	400,000	132,000	81,60	22338EMW33	33	SNR				
	400,000	132,000	82,60	22338UAVS1	33	NTN				
	400,000	132,000	78,40	MX-22338UAVS2	33	NTN				
	200,000	280,000	48,000	9,00	29240	39	NTN			



								Brands		
d	D	B	Kg	Reference						
200,000	280,000	60,000	11,48	23940	33	NTN				
	280,000	60,000	11,70	23940K	33	NTN				
	310,000	82,000	24,11	23040EMKW33	33	SNR				
	310,000	82,000	26,81	23040EMW33	33	SNR				
	310,000	109,000	30,45	24040EMK30W33	33	SNR				
	310,000	109,000	33,70	24040EMW33	33	SNR				
	340,000	85,000	31,90	29340	39	NTN				
	340,000	85,000	37,40	29340E	39	SNR				
	340,000	112,000	42,00	23140EMKW33	33	SNR				
	340,000	112,000	41,70	23140EMW33	33	SNR				
	340,000	140,000	55,05	24140EMK30W33	33	SNR				
	340,000	140,000	55,47	24140EMW33	33	SNR				
	360,000	98,000	46,57	22240EMKW33	33	SNR				
	360,000	98,000	45,40	22240EMW33	33	SNR				
	360,000	128,000	62,30	23240EMKW33	33	SNR				
	360,000	128,000	59,05	23240EMW33	33	SNR				
	400,000	122,000	72,82	29440	39	NTN-SNR				
	420,000	138,000	93,20	22340B	33	NTN				
	420,000	138,000	91,20	22340BK	33	NTN				
	420,000	138,000	46,77	22340EMKW33	33	SNR				
	420,000	138,000	47,50	22340EMW33	33	SNR				
	420,000	138,000	95,20	22340UAVS2	33	NTN				
	220,000	300,000	48,000	9,79	29244	39	NTN			
		300,000	60,000	12,80	23944	33	NTN			
		300,000	60,000	12,56	23944EMW33	33	SNR			
		300,000	60,000	12,70	23944K	33	NTN			
		340,000	90,000	33,13	23044EMKW33	33	SNR			
		340,000	90,000	32,19	23044EMW33	33	SNR			
340,000		118,000	38,00	24044EMK30W33	33	SNR				
340,000		118,000	41,17	24044EMW33	33	SNR				
360,000		85,000	34,20	29344	39	NTN				
360,000		85,000	49,00	29344E	39	SNR				
370,000		120,000	57,17	23144EMKW33	33	SNR				
370,000		120,000	54,86	23144EMW33	33	SNR				
370,000		150,000	68,00	24144EMK30W33	33	SNR				
370,000		150,000	68,00	24144EMW33	33	SNR				
400,000		108,000	58,40	22244EMKW33	33	SNR				
400,000		108,000	65,25	22244EMW33	33	SNR				
400,000		144,000	83,00	23244EMKW33	33	SNR				
400,000		144,000	82,77	23244EMW33	33	SNR				
420,000		122,000	77,30	29444	39	NTN-SNR				
460,000		145,000	115,26	22344B	33	NTN				
460,000		145,000	115,00	22344BK	33	NTN				
460,000		145,000	133,65	22344VMKW33	33	SNR				
460,000		145,000	140,25	22344VMW33	33	SNR				
228,600		400,050	139,700	77,70	2P4602	33	NTN			
240,000		320,000	60,000	13,20	23948	33	NTN			
		320,000	60,000	13,60	23948K	33	NTN			
		340,000	60,000	17,20	29248	39	NTN			
	360,000	92,000	31,67	23048EMKW33	33	SNR				
	360,000	92,000	34,91	23048EMW33	33	SNR				
	360,000	118,000	41,00	24048EMK30W33	33	SNR				
	360,000	118,000	48,20	24048EMW33	33	SNR				
	380,000	85,000	36,20	29348	39	NTN				
	380,000	85,000	48,80	29348E	39	SNR				
	400,000	128,000	62,72	23148EMKW33	33	SNR				
	400,000	128,000	64,72	23148EMW33	33	SNR				
	400,000	160,000	79,18	24148B	33	NTN				
	400,000	160,000	82,00	24148BK30	33	NTN				

								Brands		
d	D	B	Kg	Reference						
240,000	400,000	160,000	86,90	24148VMK30W33	33	SNR				
	400,000	160,000	93,80	24148VMW33	33	SNR				
	400,000	160,000	83,50	24148VW33	33	SNR				
	440,000	120,000	88,00	22248B	33	NTN				
	440,000	120,000	80,00	22248BK	33	NTN				
	440,000	120,000	93,30	22248VMW33	33	SNR				
	440,000	122,000	89,00	29448	39	NTN-SNR				
	440,000	160,000	108,00	23248B	33	NTN				
	440,000	160,000	105,00	23248BK	33	NTN				
	440,000	160,000	119,00	23248VMKW33	33	SNR				
	440,000	160,000	112,40	23248VMW33	33	SNR				
	500,000	155,000	148,00	22348B	33	NTN				
	500,000	155,000	145,00	22348BK	33	NTN				
	500,000	155,000	165,20	22348VMKW33	33	SNR				
	500,000	155,000	172,62	22348VMW33	33	SNR				
	260,000	360,000	60,000	19,00	29252	39	NTN			
		360,000	75,000	23,50	23952	33	NTN			
		400,000	104,000	48,50	23052B	33	NTN			
		400,000	104,000	46,80	23052BK	33	NTN			
		400,000	104,000	51,00	23052EMKW33	33	SNR			
		400,000	104,000	52,20	23052EMW33	33	SNR			
		400,000	140,000	65,20	24052B	33	NTN			
400,000		140,000	64,10	24052BK30	33	NTN				
400,000		140,000	63,90	24052VMK30W33	33	SNR				
400,000		140,000	65,75	24052VMW33	33	SNR				
420,000		95,000	51,34	29352	39	NTN				
420,000		95,000	55,80	29352E	39	SNR				
440,000		144,000	91,10	23152B	33	NTN				
440,000		144,000	88,60	23152BK	33	NTN				
440,000		144,000	96,50	23152VMKW33	33	SNR				
440,000		144,000	100,80	23152VMW33	33	SNR				
440,000		180,000	118,00	24152B	33	NTN				
440,000		180,000	112,00	24152BK30	33	NTN				
440,000		180,000	180,00	24152VMK30W33	33	SNR				
440,000		180,000	120,65	24152VMW33	33	SNR				
480,000		130,000	113,00	22252B	33	NTN				
480,000		130,000	104,00	22252BK	33	NTN				
480,000		130,000	35,50	22252VMW33	33	SNR				
480,000		132,000	108,00	29452	39	NTN-SNR				
480,000		174,000	141,00	23252B	33	NTN				
480,000		174,000	137,00	23252BK	33	NTN				
480,000		174,000	148,80	23252VMKW33	33	SNR				
480,000		174,000	152,45	23252VMW33	33	SNR				
480,000	174,000	138,00	2P5217L	33	NTN					
500,000	176,000	160,00	23256B	33	NTN					
540,000	164,000	192,00	22352VMW33	33	SNR					
540,000	165,000	197,00	22352B	33	NTN					
540,000	165,000	179,00	22352BK	33	NTN					
280,000	380,000	60,000	19,60	29256	39	NTN				
	380,000	75,000	24,00	23956	33	NTN				
	380,000	75,000	25,60	23956K	33	NTN				
	420,000	106,000	52,40	23056B	33	NTN				
	420,000	106,000	50,60	23056BK	33	NTN				
	420,000	106,000	55,03	23056EMKW33	33	SNR				
	420,000	106,000	54,08	23056EMW33	33	SNR				
	420,000	140,000	69,00	24056B	33	NTN				
	420,000	140,000	67,90	24056BK30	33	NTN				
	420,000	140,000	64,90	24056EMK30W33	33	SNR				
	420,000	140,000	72,30	24056EMW33	33	SNR				
	440,000	95,000	54,60	29356	39	NTN				

d	D	B	Kg	Reference			Brands
280,000	440,000	95,000	59,00	29356E	39	SNR	
	460,000	146,000	96,80	23156B	33	NTN	
	460,000	146,000	94,60	23156BK	33	NTN	
	460,000	146,000	107,40	23156VMKW33	33	SNR	
	460,000	146,000	112,05	23156VMW33	33	SNR	
	460,000	180,000	117,00	24156B	33	NTN	
	460,000	180,000	118,00	24156BK30	33	NTN	
	460,000	180,000	119,00	24156VMK30W33	33	SNR	
	460,000	180,000	127,50	24156VMW33	33	SNR	
	500,000	130,000	112,00	22256B	33	NTN	
	500,000	130,000	110,00	22256BK	33	NTN	
	500,000	176,000	145,00	23256BK	33	NTN	
	500,000	176,000	162,75	23256VMKW33	33	SNR	
	500,000	176,000	171,25	23256VMW33	33	SNR	
	520,000	145,000	139,51	29456	39	NTN	
	520,000	145,000	146,30	29456E	39	SNR	
	580,000	175,000	243,00	22356B	33	NTN	
	580,000	175,000	220,00	22356BK	33	NTN	
	580,000	175,000	241,36	22356VMW33	33	SNR	
	300,000	420,000	73,000	30,60	29260	39	NTN
420,000		90,000	38,81	23960	33	NTN	
420,000		90,000	38,70	23960K	33	NTN	
460,000		118,000	71,90	23060B	33	NTN	
460,000		118,000	70,20	23060BK	33	NTN	
460,000		118,000	84,20	23060VMKW33	33	SNR	
460,000		118,000	80,59	23060VMW33	33	SNR	
460,000		160,000	106,00	24060B	33	NTN	
460,000		160,000	96,40	24060BK30	33	NTN	
460,000		160,000	103,40	24060VMK30W33	33	SNR	
460,000		160,000	164,10	24060VMW33	33	SNR	
480,000		109,000	74,90	29360	39	NTN	
480,000		109,000	85,50	29360E	39	SNR	
500,000		160,000	125,86	23160B	33	NTN	
500,000		160,000	127,00	23160BK	33	NTN	
500,000		160,000	148,80	23160VMKW33	33	SNR	
500,000		160,000	146,20	23160VMW33	33	SNR	
500,000		200,000	155,45	24160B	33	NTN	
500,000		200,000	159,00	24160BK30	33	NTN	
500,000		200,000	128,20	24160VMK30W33	33	SNR	
500,000		200,000	175,00	24160VMW33	33	SNR	
540,000		140,000	141,00	22260B	33	NTN	
540,000		140,000	138,00	22260BK	33	NTN	
540,000		145,000	146,54	29460	39	NTN	
540,000		145,000	148,00	29460E	39	SNR	
540,000		192,000	188,47	23260B	33	NTN	
540,000		192,000	187,00	23260BK	33	NTN	
540,000		192,000	198,60	23260VMKW33	33	SNR	
540,000		192,000	205,90	23260VMW33	33	SNR	
620,000		185,000	270,00	22360B	33	NTN	
620,000		185,000	265,00	22360BK	33	NTN	
302,000		420,000	90,000	40,00	23960/302	33	NTN
315,910	520,000	210,000	161,00	2PE6303	33	NTN	
320,000	400,000	80,000	22,80	24864	33	NTN	
	400,000	80,000	22,40	24864K30	33	NTN	
	440,000	73,000	33,50	29264	39	NTN	
	440,000	90,000	41,32	23964K	33	NTN	
	440,000	90,000	41,70	23964K	33	NTN	
	480,000	121,000	77,40	23064B	33	NTN	

d	D	B	Kg	Reference			Brands	
320,000	480,000	121,000	75,50	23064BK	33	NTN		
	480,000	121,000	77,20	23064EMKW33	33	SNR		
	480,000	121,000	79,60	23064EMW33	33	SNR		
	480,000	160,000	101,91	24064B	33	NTN		
	480,000	160,000	101,00	24064BK30	33	NTN		
	500,000	109,000	79,10	29364	39	NTN		
	500,000	109,000	90,20	29364E	39	SNR		
	540,000	176,000	164,45	23164B	33	NTN		
	540,000	176,000	162,00	23164BK	33	NTN		
	540,000	176,000	176,20	23164VMKW33	33	SNR		
	540,000	176,000	187,50	23164VMW33	33	SNR		
	540,000	186,000	166,00	2P6601	33	NTN		
	540,000	186,000	160,00	2P6601K	33	NTN		
	540,000	218,000	207,00	24164B	33	NTN		
	540,000	218,000	204,00	24164BK30	33	NTN		
	580,000	150,000	168,00	22264B	33	NTN		
	580,000	150,000	168,00	22264BK	33	NTN		
	580,000	155,000	181,49	29464	39	NTN		
	580,000	155,000	181,00	29464E	39	SNR		
	580,000	208,000	236,90	23264B	33	NTN		
	580,000	208,000	236,00	23264BK	33	NTN		
	580,000	213,000	241,00	2P6404	33	NTN		
	580,000	213,000	233,00	2P6404K	33	NTN		
	330,000	460,000	90,000	43,30	23968K	33	NTN	
	340,000	460,000	73,000	34,40	29268	39	NTN	
		460,000	90,000	42,90	23968	33	NTN	
		520,000	133,000	104,00	23068B	33	NTN	
520,000		133,000	100,00	23068BK	33	NTN		
520,000		133,000	118,40	23068VMKW33	33	SNR		
520,000		133,000	118,75	23068VMW33	33	SNR		
520,000		180,000	140,00	24068B	33	NTN		
520,000		180,000	138,00	24068BK30	33	NTN		
540,000		122,000	107,00	29368	39	NTN		
580,000		190,000	205,86	23168B	33	NTN		
580,000		190,000	204,00	23168BK	33	NTN		
580,000		190,000	223,00	23168VMKW33	33	SNR		
580,000		190,000	228,40	23168VMW33	33	SNR		
580,000		243,000	269,00	24168B	33	NTN		
580,000		243,000	265,00	24168BK30	33	NTN		
580,000		243,000	266,00	24168VMW33	33	SNR		
620,000		170,000	252,00	29468	39	NTN		
620,000		224,000	300,00	23268B	33	NTN		
620,000	224,000	291,00	23268BK	33	NTN			
620,000	229,000	298,00	2P6802	33	NTN			
620,000	229,000	288,00	2P6802K	33	NTN			
360,000	440,000	60,000	19,20	23872	33	NTN		
	440,000	60,000	18,60	23872K	33	NTN		
	480,000	75,000	37,10	2P7202	33	NTN		
	480,000	75,000	36,10	2P7202K	33	NTN		
	480,000	90,000	44,96	23972	33	NTN		
	480,000	90,000	45,70	23972K	33	NTN		
	500,000	85,000	50,00	29272	39	NTN		
	520,000	133,000	92,80	2P7201	33	NTN		
	520,000	133,000	89,50	2P7201K	33	NTN		
	530,000	127,000	95,30	2P7205	33	NTN		
	530,000	127,000	92,30	2P7205K	33	NTN		
	540,000	134,000	110,00	23072B	33	NTN		
540,000	134,000	106,00	23072BK	33	NTN			
540,000	134,000	120,00	23072VMKW33	33	SNR			



								Brands		
d	D	B	Kg	Reference						
360,000	540,000	134,000	124.65	23072VMW33	33	SNR				
	540,000	180,000	147,00	24072B	33	NTN				
	540,000	180,000	145,00	24072BK30	33	NTN				
	540,000	212,000	156,48	2PE7204	33	NTN				
	540,000	212,000	156,48	2PE7206	33	NTN				
	560,000	122,000	122,00	29372	39	NTN				
	600,000	192,000	222,00	23172B	33	NTN				
	600,000	192,000	215,00	23172BK	33	NTN				
	600,000	192,000	240,78	23172VMKW33	33	SNR				
	600,000	192,000	239,50	23172VMW33	33	SNR				
	600,000	243,000	281,00	24172B	33	NTN				
	600,000	243,000	277,00	24172BK30	33	NTN				
	610,000	255,000	290,00	2P7206	33	NTN				
	610,000	255,000	277,00	2P7206K	33	NTN				
	640,000	170,000	240,00	29472	39	NTN				
	650,000	232,000	339,00	23272B	33	NTN				
	650,000	232,000	329,00	23272BK	33	NTN				
	380,000	520,000	85,000	52,60	29276	39	NTN			
		520,000	106,000	69,90	23976	33	NTN			
		520,000	106,000	67,70	23976K	33	NTN			
560,000		135,000	115,00	23076B	33	NTN				
560,000		135,000	111,00	23076BK	33	NTN				
560,000		135,000	141,90	23076VMKW33	33	SNR				
560,000		135,000	136,65	23076VMW33	33	SNR				
560,000		180,000	153,00	24076B	33	NTN				
560,000		180,000	150,00	24076BK30	33	NTN				
600,000		132,000	143,00	29376	39	NTN				
620,000		194,000	235,00	23176B	33	NTN				
620,000		194,000	228,00	23176BK	33	NTN				
620,000		243,000	292,00	24176B	33	NTN				
620,000		243,000	287,00	24176BK30	33	NTN				
670,000		175,000	266,61	29476	39	NTN				
680,000		240,000	380,00	23276B	33	NTN				
680,000		240,000	369,00	23276BK	33	NTN				
680,000		245,000	382,00	2P7603	33	NTN				
680,000		245,000	370,00	2P7603K	33	NTN				
390,000		510,000	90,000	47,30	2P7801	33	NTN			
	510,000	90,000	45,70	2P7801K	33	NTN				
400,000	500,000	100,000	45,30	24880	33	NTN				
	500,000	100,000	44,50	24880K30	33	NTN				
	540,000	85,000	55,20	29280	39	NTN				
	540,000	106,000	73,00	23980	33	NTN				
	540,000	106,000	70,70	23980K	33	NTN				
	600,000	148,000	149,00	23080B	33	NTN				
	600,000	148,000	144,00	23080BK	33	NTN				
	600,000	148,000	165,70	23080VMKW33	33	SNR				
	600,000	148,000	172,73	23080VMW33	33	SNR				
	600,000	200,000	202,00	24080B	33	NTN				
	600,000	200,000	200,00	24080BK30	33	NTN				
	620,000	132,000	148,00	29380	39	NTN				
	650,000	200,000	264,00	23180B	33	NTN				
	650,000	200,000	256,00	23180BK	33	NTN				
	650,000	250,000	329,00	24180B	33	NTN				
	650,000	250,000	324,00	24180BK30	33	NTN				
	710,000	185,000	320,95	29480	39	NTN				
	720,000	256,000	457,00	23280B	33	NTN				
	720,000	256,000	443,00	23280BK	33	NTN				
	720,000	260,000	457,00	2P8002	33	NTN				
	720,000	260,000	443,00	2P8002K	33	NTN				

								Brands		
d	D	B	Kg	Reference						
400,000	820,000	243,000	607,00	22380B	33	NTN				
420,000	520,000	75,000	34,80	23884	33	NTN				
	520,000	75,000	33,60	23884K	33	NTN				
	560,000	106,000	76,20	23984	33	NTN				
	560,000	106,000	73,80	23984K	33	NTN				
	580,000	95,000	76,60	29284	39	NTN				
	620,000	150,000	157,00	23084B	33	NTN				
	620,000	150,000	152,00	23084BK	33	NTN				
	620,000	200,000	221,00	24084B	33	NTN				
	620,000	200,000	207,00	24084BK30	33	NTN				
	650,000	140,000	172,00	29384	39	NTN				
	700,000	224,000	354,00	23184B	33	NTN				
	700,000	224,000	343,00	23184BK	33	NTN				
	700,000	280,000	440,00	24184B	33	NTN				
	700,000	280,000	433,00	24184BK30	33	NTN				
	730,000	185,000	428,37	29484	39	NTN				
	760,000	272,000	544,00	23284B	33	NTN				
	760,000	272,000	528,00	23284BK	33	NTN				
	440,000	600,000	95,000	79,60	29288	39	NTN			
600,000		118,000	101,00	23988	33	NTN-SNR				
600,000		118,000	98,00	23988K	33	NTN				
650,000		157,000	180,99	23088B	33	NTN				
650,000		157,000	175,00	23088BK	33	NTN				
650,000		212,000	245,00	24088B	33	NTN				
650,000		212,000	241,00	24088BK30	33	NTN				
680,000		145,000	195,00	29388	39	NTN				
720,000		226,000	370,00	23188B	33	NTN				
720,000		226,000	358,00	23188BK	33	NTN				
720,000		280,000	456,00	24188B	33	NTN				
720,000		280,000	449,00	24188BK30	33	NTN				
780,000		206,000	428,00	29488	39	NTN				
790,000		280,000	586,46	23288B	33	NTN				
790,000		280,000	582,00	23288BK	33	NTN				
790,000		285,000	588,00	2P8802	33	NTN				
790,000		285,000	576,00	2P8802K	33	NTN				
450,000		620,000	190,000	171,00	2P9002	33	NTN			
	620,000	190,000	157,00	2P9002K	33	NTN				
460,000	580,000	118,000	73,60	24892	33	NTN				
	580,000	118,000	72,30	24892K30	33	NTN				
	620,000	95,000	82,80	29292	39	NTN				
	620,000	118,000	107,00	23992	33	NTN				
	620,000	118,000	104,00	23992K	33	NTN				
	620,000	140,000	122,00	2P9203	33	NTN				
	620,000	140,000	118,00	2P9203K	33	NTN				
	680,000	163,000	206,00	23092B	33	NTN				
	680,000	163,000	200,00	23092BK	33	NTN				
	680,000	218,000	308,00	24092B	33	NTN				
	680,000	218,000	272,00	24092BK30	33	NTN				
	710,000	150,000	221,00	29392	39	NTN				
	760,000	240,000	443,00	23192B	33	NTN				
	760,000	240,000	429,00	23192BK	33	NTN				
	760,000	300,000	550,00	24192B	33	NTN				
	760,000	300,000	541,00	24192BK30	33	NTN				
	800,000	206,000	443,00	29492	39	NTN				
	830,000	296,000	704,00	23292B	33	NTN				
	830,000	296,000	683,00	23292BK	33	NTN				
	480,000	600,000	90,000	57,80	23896	33	NTN			

										Brands		
d	D	B	Kg	Reference								
480,000	650,000	103,000	98,60	29296	39	NTN						
	650,000	128,000	123,00	23996	33	NTN						
	650,000	128,000	119,00	23996K	33	NTN						
	660,000	200,000	195,00	2P9602	33	NTN						
	660,000	200,000	185,00	2P9602K	33	NTN						
	700,000	165,000	217,00	23096B	33	NTN						
	700,000	165,000	209,00	23096BK	33	NTN						
	700,000	218,000	282,00	24096B	33	NTN						
	700,000	218,000	280,00	24096BK30	33	NTN						
	730,000	150,000	228,00	29396	39	NTN						
	790,000	248,000	492,00	23196B	33	NTN						
	790,000	248,000	477,00	23196BK	33	NTN						
	790,000	308,000	608,00	24196B	33	NTN						
	790,000	308,000	600,00	24196BK30	33	NTN						
	850,000	224,000	552,00	29496	39	NTN						
	870,000	310,000	814,00	23296B	33	NTN						
	870,000	310,000	790,00	23296BK	33	NTN						
	490,000	650,000	130,000	114,00	2P9801	33	NTN					
		650,000	130,000	109,00	2P9801K	33	NTN					
	500,000	620,000	90,000	59,60	238/500	33	NTN					
620,000		90,000	57,50	238/500K	33	NTN						
670,000		128,000	131,00	239/500	33	NTN						
670,000		128,000	127,00	239/500K	33	NTN						
720,000		167,000	226,00	230/500B	33	NTN						
720,000		167,000	218,00	230/500BK	33	NTN						
720,000		218,000	295,00	240/500B	33	NTN						
720,000		218,000	290,00	240/500BK30	33	NTN						
750,000		150,000	235,00	293/500	39	NTN						
830,000		264,000	584,00	231/500B	33	NTN						
830,000		264,000	566,00	231/500BK	33	NTN						
830,000		325,000	716,00	241/500B	33	NTN						
830,000		325,000	705,00	241/500BK30	33	NTN						
920,000		336,000	1 000,00	232/500B	33	NTN						
920,000		336,000	971,00	232/500BK	33	NTN						
530,000	710,000	136,000	157,00	239/530	33	NTN						
	710,000	136,000	152,00	239/530K	33	NTN						
	750,000	248,000	329,20	2P0603	33	NTN						
	780,000	185,000	306,00	230/530B	33	NTN						
	780,000	185,000	295,00	230/530BK	33	NTN						
	780,000	250,000	413,00	240/530B	33	NTN						
	780,000	250,000	406,00	240/530BK30	33	NTN						
	870,000	272,000	631,08	231/530B	33	NTN						
	870,000	272,000	633,00	231/530BK	33	NTN						
	870,000	335,000	800,00	241/530B	33	NTN						
	870,000	335,000	788,00	241/530BK30	33	NTN						
	980,000	355,000	1 200,00	232/530B	33	NTN						
980,000	355,000	1 170,00	232/530BK	33	NTN							
540,000	980,000	250,000	825,00	294/560/540	39	NTN						
545,000	755,000	230,000	322,00	2P10901	33	NTN						
	755,000	230,000	286,00	2P10901K	33	NTN						
560,000	680,000	90,000	66,10	238/560	33	NTN						
	680,000	90,000	63,70	238/560K	33	NTN						
	750,000	140,000	182,00	239/560	33	NTN						
	750,000	140,000	176,00	239/560K	33	NTN						
	750,000	248,000	297,80	2P1201	33	NTN						
	820,000	195,000	347,73	230/560B	33	NTN						

										Brands		
d	D	B	Kg	Reference								
560,000	820,000	195,000	340,00	230/560BK	33	NTN						
	820,000	258,000	467,00	240/560B	33	NTN						
	820,000	258,000	459,00	240/560BK30	33	NTN						
	920,000	280,000	752,00	231/560B	33	NTN						
	920,000	280,000	729,00	231/560BK	33	NTN						
	920,000	355,000	948,00	241/560B	33	NTN						
	920,000	355,000	934,00	241/560BK30	33	NTN						
	980,000	250,000	815,00	294/560	39	NTN						
	1 030,000	365,000	1 360,00	232/560B	33	NTN						
	1 030,000	365,000	1 320,00	232/560BK	33	NTN						
	600,000	800,000	150,000	209,00	239/600	33	NTN					
		800,000	150,000	211,00	239/600K	33	NTN					
		870,000	200,000	400,00	230/600B	33	NTN					
		870,000	200,000	386,00	230/600BK	33	NTN					
		870,000	272,000	544,00	240/600B	33	NTN					
870,000		272,000	535,00	240/600BK30	33	NTN						
980,000		300,000	908,00	231/600B	33	NTN						
980,000		300,000	880,00	231/600BK	33	NTN						
980,000		375,000	1 130,00	241/600B	33	NTN						
980,000		375,000	1 110,00	241/600BK30	33	NTN						
1 030,000		258,000	898,00	294/600	39	NTN						
1 090,000		388,000	1 540,00	232/600B	33	NTN						
1 090,000	388,000	1 490,00	232/600BK	33	NTN							
630,000	780,000	150,000	158,00	248/630	33	NTN						
	780,000	150,000	155,00	248/630K30	33	NTN						
	850,000	165,000	277,00	239/630	33	NTN						
	850,000	165,000	268,00	239/630K	33	NTN						
	920,000	212,000	472,39	230/630B	33	NTN						
	920,000	212,000	464,00	230/630BK	33	NTN						
	920,000	290,000	657,00	240/630B	33	NTN						
	920,000	290,000	646,00	240/630BK30	33	NTN						
	1 030,000	315,000	1 050,00	231/630B	33	NTN						
	1 030,000	315,000	1 020,00	231/630BK	33	NTN						
	1 030,000	400,000	1 330,00	241/630B	33	NTN						
	1 030,000	400,000	1 310,00	241/630BK30	33	NTN						
1 150,000	412,000	1 900,00	232/630B	33	NTN							
1 150,000	412,000	1 840,00	232/630BK	33	NTN							
670,000	900,000	170,000	317,00	239/670	33	NTN						
	980,000	230,000	578,39	230/670B	33	NTN						
	980,000	308,000	794,00	240/670B	33	NTN						
	1 090,000	336,000	1 250,00	231/670B	33	NTN						
	1 090,000	412,000	1 530,00	241/670B	33	NTN						
	1 220,000	438,000	2 270,00	232/670B	33	NTN						
680,000	980,000	220,000	550,00	2P13601	33	NTN						
	980,000	220,000	533,00	2P13601K	33	NTN						
710,000	950,000	145,000	292,00	292/710	39	NTN						
	950,000	180,000	375,00	239/710	33	NTN						
	950,000	180,000	363,00	239/710K	33	NTN						
	1 030,000	236,000	663,00	230/710B	33	NTN						
	1 030,000	236,000	640,00	230/710BK	33	NTN						
	1 030,000	315,000	884,00	240/710B	33	NTN						
	1 030,000	315,000	870,00	240/710BK30	33	NTN						
	1 150,000	345,000	1 420,00	231/710B	33	NTN						
	1 150,000	345,000	1 380,00	231/710BK	33	NTN						
	1 150,000	438,000	1 800,00	241								

d	D	B	Kg	Reference					
710,000	1 280,000	450,000	2 470,000	232/710BK	33	NTN			
750,000	920,000	128,000	184,58	238/750	33	NTN			
	920,000	128,000	173,00	238/750K	33	NTN			
	1 000,000	185,000	412,00	239/750	33	NTN			
	1 000,000	185,000	399,00	239/750K	33	NTN			
	1 090,000	250,000	790,00	230/750B	33	NTN			
	1 090,000	250,000	763,00	230/750BK	33	NTN			
	1 090,000	335,000	1 060,00	240/750B	33	NTN			
	1 090,000	335,000	1 040,00	240/750BK30	33	NTN			
	1 220,000	365,000	1 700,00	231/750B	33	NTN			
	1 220,000	365,000	1 650,00	231/750BK	33	NTN			
	1 280,000	315,000	1 700,00	294/750	39	NTN			
	1 360,000	475,000	3 050,00	232/750B	33	NTN			
	1 360,000	475,000	2 960,00	232/750BK	33	NTN			
760,000	1 140,000	325,000	1 150,00	2P15203	33	NTN			
	1 140,000	325,000	1 060,00	2P15203K	33	NTN			
780,000	1 220,000	375,000	1 610,00	2P15605	33	NTN			
	1 220,000	375,000	1 560,00	2P15605K	33	NTN			
790,000	1 100,000	310,000	953,00	2P15802	33	NTN			
	1 100,000	310,000	817,00	2P15802K	33	NTN			
800,000	1 060,000	195,000	467,12	239/800	33	NTN			
	1 060,000	195,000	471,00	239/800K	33	NTN			
	1 150,000	258,000	890,00	230/800B	33	NTN			
	1 150,000	258,000	859,00	230/800BK	33	NTN			
	1 150,000	345,000	1 190,00	240/800B	33	NTN			
	1 150,000	345,000	1 170,00	240/800BK30	33	NTN			
	1 280,000	375,000	1 890,00	231/800B	33	NTN			
	1 280,000	375,000	1 830,00	231/800BK	33	NTN			
	1 360,000	335,000	2 040,00	294/800	39	NTN			
842,000	1 220,000	502,000	1 560,00	2P7010	33	NTN			
850,000	1 030,000	136,000	232,00	238/850	33	NTN			
	1 030,000	136,000	223,00	238/850K	33	NTN			
	1 120,000	200,000	550,00	239/850	33	NTN			
	1 120,000	200,000	532,00	239/850K	33	NTN			
	1 220,000	272,000	1 050,00	230/850B	33	NTN			
	1 220,000	272,000	1 010,00	230/850BK	33	NTN			
	1 220,000	290,000	1 100,00	2P17001	33	NTN			
	1 220,000	290,000	1 070,00	2P17001K	33	NTN			
	1 220,000	290,000	1 060,00	2P17011	33	NTN			
	1 220,000	290,000	1 020,00	2P17011K	33	NTN			
	1 220,000	330,000	1 240,00	2P17012	33	NTN			
	1 220,000	330,000	1 160,00	2P17012K	33	NTN			
	1 220,000	365,000	1 410,00	240/850B	33	NTN			
	1 220,000	365,000	1 390,00	240/850BK30	33	NTN			
	1 280,000	375,000	1 580,00	2P7012	33	NTN			
	1 360,000	400,000	2 270,00	231/850B	33	NTN			
	1 360,000	400,000	2 200,00	231/850BK	33	NTN			
	1 500,000	515,000	3 890,00	232/850B	33	NTN			
	1 500,000	515,000	3 780,00	232/850BK	33	NTN			
900,000	900,000	170,000	307,00	239/670K	33	NTN			
	980,000	230,000	573,00	230/670BK	33	NTN			
	980,000	308,000	781,00	240/670BK30	33	NTN			
	1 090,000	336,000	1 210,00	231/670BK	33	NTN			
	1 090,000	412,000	1 510,00	241/670BK30	33	NTN			

d	D	B	Kg	Reference					
900,000	1 180,000	206,000	623,00	239/900	33	NTN			
	1 180,000	206,000	603,00	239/900K	33	NTN			
	1 220,000	438,000	2 200,00	232/670BK	33	NTN			
	1 280,000	280,000	1 170,00	230/900B	33	NTN			
	1 280,000	280,000	1 130,00	230/900BK	33	NTN			
	1 280,000	375,000	1 570,00	240/900B	33	NTN			
	1 280,000	375,000	1 540,00	240/900BK30	33	NTN			
	1 280,000	375,000	1 550,00	2P18003K30	33	NTN			
	1 420,000	412,000	2 500,00	231/900B	33	NTN			
	1 420,000	412,000	2 420,00	231/900BK	33	NTN			
950,000	1 250,000	224,000	774,00	239/950	33	NTN			
	1 250,000	224,000	749,00	239/950K	33	NTN			
	1 280,000	260,000	921,00	2P19014	33	NTN			
	1 280,000	260,000	888,00	2P19014K	33	NTN			
	1 330,000	300,000	1 210,00	2P19013	33	NTN			
	1 330,000	300,000	1 170,00	2P19013K	33	NTN			
	1 360,000	300,000	1 430,00	230/950B	33	NTN			
	1 360,000	300,000	1 380,00	230/950BK	33	NTN			
	1 360,000	320,000	1 450,00	2P19022	33	NTN			
	1 360,000	320,000	1 400,00	2P19022K	33	NTN			
	1 360,000	412,000	1 970,00	240/950B	33	NTN			
	1 360,000	412,000	1 940,00	240/950BK30	33	NTN			
	1 400,000	380,000	1 940,00	2P19019	33	NTN			
	1 400,000	380,000	1 870,00	2P19019K	33	NTN			
1 000,000	1 320,000	236,000	916,00	239/1000	33	NTN			
	1 320,000	236,000	887,00	239/1000K	33	NTN			
	1 320,000	258,000	911,00	2P20002	33	NTN			
	1 320,000	258,000	877,00	2P20002K	33	NTN			
	1 420,000	308,000	1 580,00	230/1000B	33	NTN			
	1 420,000	308,000	1 520,00	230/1000BK	33	NTN			
	1 420,000	412,000	2 110,00	240/1000B	33	NTN			
	1 420,000	412,000	2 080,00	240/1000BK30	33	NTN			
	1 580,000	580,000	4 220,00	241/1000BK30	33	NTN			
1 050,000	1 500,000	412,000	2 290,00	2P21001	33	NTN			
	1 500,000	412,000	2 200,00	2P21001K	33	NTN			
1 060,000	1 400,000	206,000	874,00	292/1060	39	NTN			
	1 400,000	250,000	1 090,00	239/1060	33	NTN			
	1 400,000	250,000	1 060,00	239/1060K	33	NTN			
	1 500,000	325,000	1 850,00	230/1060B	33	NTN			
	1 500,000	325,000	1 790,00	230/1060BK	33	NTN			
	1 500,000	340,000	1 870,00	2P21202	33	NTN			
	1 500,000	340,000	1 810,00	2P21202K	33	NTN			
	1 500,000	438,000	2 450,00	240/1060B	33	NTN			
	1 500,000	438,000	2 140,00	240/1060BK30	33	NTN			
1 120,000	1 360,000	180,000	536,00	238/1120	33	NTN			
	1 360,000	180,000	517,00	238/1120K	33	NTN			
	1 460,000	250,000	1 140,00	239/1120	33	NTN			
	1 460,000	250,000	1 100,00	239/1120K	33	NTN			
	1 580,000	345,000	2 160,00	230/1120B	33	NTN			
	1 580,000	345,000	2 090,00	230/1120BK	33	NTN			
	1 580,000	462,000	2 890,00	240/1120B	33	NTN			
	1 580,000	462,000	2 840,00	240/1120BK30	33	NTN			
1 180,000	1 420,000	180,000	559,00	238/1180	33	NTN			
	1 420,000	180,000	539,00	238/1180K	33	NTN			
	1 540,000	272,000	1 390,00	239/1180	33	NTN			
	1 540,000	272,000	1 340,00	239/1180K	33	NTN			

d	D	B	Kg	Reference			
1 180,000	1 540,000	355,000	1 740,00	249/1180	33	NTN	
	1 540,000	355,000	1 660,00	249/1180K30	33	NTN	
	1 660,000	475,000	3 220,00	240/1180B	33	NTN	
	1 660,000	475,000	3 170,00	240/1180BK30	33	NTN	
1 200,000	1 700,000	410,000	2 860,00	2P24005	33	NTN	
	1 700,000	410,000	2 750,00	2P24005K	33	NTN	
	1 700,000	410,000	2 830,00	2P24007	33	NTN	
	1 700,000	410,000	2 730,00	2P24007K	33	NTN	
	1 700,000	730,000	4 220,00	2PE24006	33	NTN	
1 250,000	1 500,000	185,000	630,00	238/1250	33	NTN	
	1 630,000	280,000	1 600,00	239/1250	33	NTN	
	1 630,000	280,000	1 550,00	239/1250K	33	NTN	
	1 750,000	390,000	2 880,00	2P25002	33	NTN	
	1 750,000	390,000	2 780,00	2P25002K	33	NTN	
1 320,000	1 720,000	300,000	1 900,00	239/1320	33	NTN	
	1 720,000	300,000	1 840,00	239/1320K	33	NTN	
	1 850,000	480,000	3 830,00	2P26402	33	NTN	
	1 850,000	480,000	3 670,00	2P26402K	33	NTN	
	1 850,000	530,000	4 320,00	240/1320B	33	NTN	
	1 850,000	530,000	4 240,00	240/1320BK30	33	NTN	
1 400,000	1 820,000	315,000	2 230,00	239/1400	33	NTN	
	1 820,000	315,000	2 160,00	239/1400K	33	NTN	
1 500,000	1 820,000	315,000	1 660,00	248/1500	33	NTN	
	1 820,000	315,000	1 580,00	248/1500K30	33	NTN	
1 800,000	2 180,000	375,000	2 830,00	248/1800	33	NTN	
	2 180,000	375,000	2 770,00	248/1800K30	33	NTN	



Classification by dimensions – Classement par dimensions
Klassifizierung nach Abmessungen – Classificazione per dimensione
Clasificación por dimensiones – Classificação por dimensões
Классификация по размерам – Klasyfikacja wg wymiarów



Needle roller bearing



Nadellager



Rodamientos
de agujas



Игольчатые
подшипники



Roulements
à aiguilles



Cuscinetti a rullini



Rolamentos
de agulhas



Łożyska igielkowe



								Brands	
d	D	B	Kg	Reference					
3,000	5,700	4,900	0,001	K3X5.7X4.9	40	NTN			
	6,000	6,800	0,001	K3X6X7	40	NTN			
	6,500	6,000	0,002	HK0306	47	NTN			
	6,500	6,000	0,001	HKS3X6.5X6	47	NTN			
	10,000	17,000	0,01	KR0	44	NTN			
	10,000	17,000	0,01	KROLL	44	NTN			
	10,000	17,000	0,01	KR0X	44	NTN			
	10,000	17,000	0,01	KR10	44	NTN			
	10,000	17,000	0,01	KR10LL	44	NTN			
	10,000	17,000	0,02	KR10X	44	NTN			
	10,000	17,000	0,03	KR10XLL	44	NTN			
4,000	6,000	7,800	0,001	K4X6X7.8X	40	NTN			
	7,000	6,800	0,001	K4X7X7	40	NTN			
	8,000	8,000	0,01	BK0408	48	NTN			
	8,000	8,000	0,004	HK0408	47	NTN			
	8,000	15,800	0,01	HK24X8X15.8	47	NTN			
	10,000	7,000	0,01	RNA0-4X10X7X	41	NTN			
	11,000	23,900	0,03	KDX4X11X23.9	61	NTN			
	12,000	20,000	0,02	KR12	44	NTN			
	12,000	20,000	0,01	KR12LL	44	NTN			
	12,000	20,000	0,01	KR12X	44	NTN			
	12,000	20,000	0,02	KR12XLL	44	NTN			
	12,000	20,000	0,01	KR2	44	NTN			
	12,000	20,000	0,02	KR2LL	44	NTN			
	12,000	20,000	0,01	KR2XLL	44	NTN			
	4,762	12,700	23,000	0,01	CR8	44	NTN		
12,700		27,000	0,01	CR8X	44	NTN			
5,000	7,000	10,000	0,00	1R5X7X10	55	NTN			
	8,000	7,800	0,002	K5X8X8	40	NTN			
	8,000	9,800	0,002	K5X8X10	40	NTN			
	8,000	12,000	0,01	1R5X8X12	55	NTN			
	8,000	16,000	0,01	1R5X8X16	55	NTN			
	9,000	9,000	0,01	BK0509	48	NTN			
	9,000	9,000	0,002	HK0509	47	NTN			
	10,000	8,000	0,004	RNA0-5X10X8	41	NTN			
	10,000	10,000	0,01	NK5/10	41	NTN			
	10,000	12,000	0,01	NK5/12	41	NTN			
	13,000	10,000	0,01	RNA495	41	NTN			
	13,000	23,000	0,01	KR13	44	NTN			
	13,000	23,000	0,01	KR13LL	44	NTN			
	13,000	23,000	0,01	KR13X	44	NTN			
	13,000	23,000	0,02	KR13XLL	44	NTN			
	13,000	23,000	0,03	KR3	44	NTN			
	13,000	23,000	0,03	KR3LL	44	NTN			
	13,000	23,000	0,03	KR3XLL	44	NTN			
	14,000	6,000	0,01	NATR5X14X6	45	NTN			
	15,000	12,000	0,02	NK8/12+1R5X8X12	42	NTN			
	15,000	16,000	0,15	NK8/16+1R5X8X16	42	NTN			
	16,000	12,000	0,04	NATR5	45	NTN			
	16,000	12,000	0,04	NATR5LL	45-A	NTN			
	16,000	12,000	0,04	NATR5X	45	NTN			
	16,000	12,000	0,04	NATR5XLL	45-A	NTN			
	16,000	12,000	0,04	NATV5	46	NTN			
	16,000	12,000	0,04	NATV5LL	46	NTN			
	16,000	12,000	0,05	NATV5X	46	NTN			
	16,000	12,000	0,04	NATV5XLL	46	NTN			
	6,000	7,900	10,000	0,00	1R6X7.9X10	55	NTN		
8,000		10,000	0,01	1R6X8X10	55	NTN			

								Brands	
d	D	B	Kg	Reference					
6,000	9,000	7,800	0,002	K6X9X7.8	40	NTN			
	9,000	7,800	0,003	K6X9X8	40	NTN			
	9,000	9,800	0,003	K6X9X10	40	NTN			
	9,000	12,000	0,01	1R6X9X12	55	NTN			
	9,000	16,000	0,01	1R6X9X16	55	NTN			
	10,000	8,000	0,004	HKS6X10X8M	47	NTN			
	10,000	9,000	0,01	BK0609	48	NTN			
	10,000	9,000	0,002	HK0609	47	NTN			
	10,000	10,000	0,01	1R6X10X10	55	NTN			
	10,000	12,800	0,004	K6X10X13	40	NTN			
	10,000	13,000	0,01	1R6X10X13	55	NTN			
	12,000	7,000	0,01	RNA0-6X12X7X	41	NTN			
	12,000	8,000	0,01	RNA0-6X12X8X	41	NTN			
	12,000	10,000	0,01	NK6/10	41	NTN			
	12,000	12,000	0,02	NK6/12	41	NTN			
	13,000	8,000	0,01	RNA0-6X13X8	41	NTN			
	16,000	12,000	0,04	NK9/12+1R6X9X12	42	NTN			
	16,000	16,000	0,03	NK9/16+1R6X9X16	42	NTN			
	16,000	28,000	0,06	KR16	44	NTN			
	16,000	28,000	0,02	KR16LL	44	NTN			
	16,000	28,000	0,06	KR6	44	NTN			
	16,000	28,000	0,06	KR6LL	44	NTN			
	16,000	28,000	0,06	KR6X	44	NTN			
	16,000	28,000	0,06	KR6XLL	44	NTN			
	16,000	28,000	0,04	KRU16LL	44	NTN			
	16,000	28,000	0,02	KRU16XLL	44	NTN			
	17,000	12,000	0,01	HKZ6X17X12	47	NTN			
	19,000	12,000	0,07	NA22/6LL	43	NTN			
	19,000	12,000	0,07	NA22/6XLL	43	NTN			
	19,000	12,000	0,06	NATR6	45	NTN			
	19,000	12,000	0,02	NATR6LL	45-A	NTN			
	19,000	12,000	0,06	NATR6X	45	NTN			
	19,000	12,000	0,06	NATR6XLL	45-A	NTN			
19,000	12,000	0,06	NATV6	46	NTN				
19,000	12,000	0,06	NATV6LL	46	NTN				
19,000	12,000	0,06	NATV6X	46	NTN				
19,000	12,000	0,06	NATV6XLL	46	NTN				
6,350	15,875	27,800	0,02	CRV10XLL	44	NTN			
7,000	9,000	10,000	0,00	1R7X9X10	55	NTN			
	10,000	7,800	0,002	K7X10X8	40	NTN			
	10,000	9,800	0,003	K7X10X10	40	NTN			
	10,000	9,800	0,01	KBK7X10X9.8	40	NTN			
	10,000	10,500	0,01	1R7X10X10.5	55	NTN			
	10,000	12,000	0,01	1R7X10X12	55	NTN			
	10,000	12,800	0,002	KV7X10X12.8	40	NTN			
	10,000	16,000	0,01	1R7X10X16	55	NTN			
	11,000	9,000	0,01	BK0709	48	NTN			
	11,000	9,000	0,003	HK0709	47	NTN			
	12,000	16,000	0,02	1R7X12X16	55	NTN			
	14,000	8,000	0,01	RNA0-7X14X8	41	NTN			
	14,000	10,000	0,02	NK7/10	41	NTN			
	14,000	12,000	0,02	NK7/12	41	NTN			
16,000	8,000	0,01	RNAB2/5	43-A	NTN				
16,000	8,000	0,02	RNAB2/5X	43-A	NTN				
17,000	12,000	0,03	NK10/12+1R7X10X12	42	NTN				
17,000	16,000	0,06	NK10/16+1R7X10X16	42	NTN				
7,940	11,940	7,800	0,01	KV7.9X11.9X7.8	40	NTN			
8,000	10,000	11,000	0,00	1R8X10X11	55	NTN			



								Brands	
d	D	B	Kg	Reference					
8,000	11,000	7,800	0,003	K8X11X8	40	NTN			
	11,000	7,800	0,005	KV8X11X8	40	NTN			
	11,000	8,600	0,004	K8X11X8.6	40	NTN			
	11,000	8,800	0,01	KBK8X11X8.8	40	NTN			
	11,000	9,800	0,004	K8X11X10	40	NTN			
	11,000	9,800	0,002	KV8X11X10	40	NTN			
	11,000	11,800	0,01	KBK8X11X11.8	40	NTN			
	11,000	12,800	0,01	K8X11X13	40	NTN			
	12,000	8,000	0,002	HKS8X12X8	47	NTN			
	12,000	9,000	0,01	HKS8X12X9M	47	NTN			
	12,000	9,800	0,002	K8X12X10	40	NTN			
	12,000	10,000	0,02	1R8X12X10	55	NTN			
	12,000	10,000	0,01	BK0810	48	NTN			
	12,000	10,000	0,003	HK0810	47	NTN			
	12,000	10,500	0,01	1R8X12X10.5	55	NTN			
	12,000	11,000	0,01	K8X12X11	40	NTN			
	12,000	12,000	0,02	1R8X12X12	55	NTN			
	12,000	12,500	0,01	1R8X12X12.5	55	NTN			
	12,000	12,800	0,01	K8X12X13	40	NTN			
	12,600	10,500	0,01	HKS8X12.6X10.5	47	NTN			
	14,000	16,000	0,01	1R8X14X16	55	NTN			
	15,000	10,000	0,01	RNA0-8X15X10	41	NTN			
	15,000	10,000	0,02	RNA496	41	NTN			
	15,000	12,000	0,02	HMK0812L	47	NTN			
	15,000	12,000	0,03	NK8/12	41	NTN			
	15,000	14,000	0,02	HMK0814LL	47	NTN			
	15,000	15,000	0,03	HMK0815	47	NTN			
	15,000	15,000	0,04	NK8X15X15	41	NTN			
	15,000	16,000	0,04	NK8/16	41	NTN			
	15,000	20,000	0,02	HMK0820	47	NTN			
	15,875	31,800	0,02	CR10X	44	NTN			
	16,000	13,000	0,01	NKS8	41	NTN			
	16,000	28,000	0,06	KR16X	44	NTN			
	16,000	28,000	0,06	KR16XLL	44	NTN			
	19,000	11,000	0,05	NA498	42	NTN			
	19,000	32,000	0,09	KR19	44	NTN			
	19,000	32,000	0,09	KR19LL	44	NTN			
	19,000	32,000	0,03	KR19XLL	44	NTN			
	19,000	32,000	0,10	KR9	44	NTN			
	19,000	32,000	0,09	KR9LL	44	NTN			
	19,000	32,000	0,10	KR9X	44	NTN			
	19,000	32,000	0,10	KR9XLL	44	NTN			
	19,000	32,000	0,03	KRT19LL	44	NTN			
	19,000	32,000	0,03	KRU19	44	NTN			
	19,000	32,000	0,06	KRU19LL	44	NTN			
	19,000	32,000	0,10	KRVT19LL	44	NTN			
	24,000	12,000	0,10	NA22/8LL	43	NTN			
	24,000	12,000	0,10	NA22/8XLL	43	NTN			
	24,000	15,000	0,08	NATR8	45	NTN			
	24,000	15,000	0,08	NATR8LL	45-A	NTN			
	24,000	15,000	0,08	NATR8X	45	NTN			
	24,000	15,000	0,12	NATR8XLL	45-A	NTN			
	24,000	15,000	0,13	NATV8	46	NTN			
	24,000	15,000	0,04	NATV8LL	46	NTN			
	24,000	15,000	0,13	NATV8X	46	NTN			
	24,000	15,000	0,12	NATV8XLL	46	NTN			
34,000	56,000	0,30	ARX8X34X56	59	NTN				
8,500	24,000	3,000	0,03	XS8.5X24X3	58	NTN			
	25,000	3,000	0,01	XS8.5X25X3	58	NTN			
	30,000	3,000	0,04	XS8.5X30X3	58	NTN			

								Brands		
d	D	B	Kg	Reference						
9,000	12,000	9,800	0,004	K9X12X10	40	NTN				
	12,000	9,800	0,01	KV9X12X10	40	NTN				
	12,000	11,000	0,01	1R9X12X11	55	NTN				
	12,000	11,500	0,01	KBK9X12X11.7	40	NTN				
	12,000	12,000	0,01	1R9X12X12	55	NTN				
	12,000	12,000	0,01	KBK9X12X12	40	NTN				
	12,000	12,800	0,01	K9X12X13	40	NTN				
	12,000	16,000	0,02	1R9X12X16	55	NTN				
	12,000	32,800	0,02	K9X12X32.8	40	NTN				
	13,000	10,000	0,004	BK0910	48	NTN				
	13,000	10,000	0,004	HK0910	47	NTN				
	13,000	12,000	0,01	BK0912	48	NTN				
	13,000	12,000	0,01	HK0912	47	NTN				
	15,000	16,000	0,03	1R9X15X16	55	NTN				
	16,000	12,000	0,02	HMK0912	47	NTN				
	16,000	12,000	0,03	NK9/12	41	NTN				
	16,000	16,000	0,01	HMK0916	47	NTN				
	16,000	16,000	0,04	NK9/16	41	NTN				
	19,000	12,000	0,06	NK12/12+1R9X12X12	42	NTN				
	19,000	16,000	0,07	NK12/16+1R9X12X16	42	NTN				
	9,525	14,288	12,950	0,01	M1-060908	55	NTN			
		15,875	19,300	0,02	M1-061012	55	NTN			
		15,875	25,650	0,05	M1-061016	55	NTN			
		19,050	36,500	0,04	CRV12X	44	NTN			
19,050		36,500	0,04	CRV12XLL	44	NTN				
22,225		36,500	0,05	CRV14XLL	44	NTN				
10,000		13,000	9,800	0,003	K10X13X10	40	NTN			
	13,000	12,500	0,01	1R10X13X12.5	55	NTN				
	13,000	12,800	0,01	K10X13X13	40	NTN				
	13,000	14,800	0,002	K10X13X14.8	40	NTN				
	14,000	7,800	0,01	K10X14X8	40	NTN				
	14,000	7,800	0,01	PK10X14X7.8	40	NTN				
	14,000	8,800	0,01	K10X14X8.8	40	NTN				
	14,000	8,800	0,01	KMJ10X14X8.8	40	NTN				
	14,000	8,800	0,01	PK10X14X8.8	40	NTN				
	14,000	9,300	0,003	KMJ10X14X9.3	40	NTN				
	14,000	9,800	0,01	K10X14X10	40	NTN				
	14,000	9,800	0,01	KMJ10X14X9.8	40	NTN				
	14,000	9,800	0,01	PK10X14X9.8	40	NTN				
	14,000	10,000	0,01	BK1010	48	NTN				
	14,000	10,000	0,01	HK1010	47	NTN				
	14,000	10,000	0,01	HK1010D	47	NTN				
	14,000	11,300	0,01	KMJ10X14X11.3	40	NTN				
	14,000	12,000	0,01	1R10X14X12	55	NTN				
	14,000	12,000	0,01	BK1012	48	NTN				
	14,000	12,000	0,01	HK1012	47	NTN				
	14,000	12,500	0,02	KBK10X14X12.5	40	NTN				
	14,000	12,800	0,01	K10X14X13	40	NTN				
	14,000	13,000	0,02	1R10X14X13	55	NTN				
	14,000	14,000	0,01	HKS10X14X14M	47	NTN				
	14,000	14,800	0,01	KBK10X14X14.8	40	NTN				
	14,000	15,000	0,02	BK1015	48	NTN				
	14,000	15,000	0,01	HK1015	47	NTN				
	14,000	16,000	0,03	1R10X14X16	55	NTN				
	14,000	20,000	0,04	1R10X14X20	55	NTN				
	15,000	7,800	0,01	K10X15X7.8	40	NTN				
	15,000	15,000	0,02	HKS10X15X15	47	NTN				
	15,000	15,500	0,01	1R10X15X15.5	55	NTN				
	15,000	20,500	0,02	1R10X15X20.5	55	NTN				
	16,000	11,800	0,02	K10X16X12	40	NTN				

								Brands	
d	D	B	Kg	Reference					
10,000	16,000	16,000	0,03	1R10X16X16	55	NTN			
	17,000	10,000	0,01	HMK1010	47	NTN			
	17,000	10,000	0,01	RNA0-10X17X10	41	NTN			
	17,000	12,000	0,02	HMK1012	47	NTN			
	17,000	12,000	0,03	HMK1012L	47	NTN			
	17,000	12,000	0,03	NK10/12	41	NTN			
	17,000	14,000	0,02	HMK1014LL	47	NTN			
	17,000	15,000	0,03	HMK1015	47	NTN			
	17,000	15,000	0,04	NK10X17X15	41	NTN			
	17,000	16,000	0,02	NK10/16	41	NTN			
	17,000	20,000	0,05	HMK1020	47	NTN			
	19,000	10,000	0,03	RNAB2/6	43-A	NTN			
	19,000	10,000	0,03	RNAB2/6X	43-A	NTN			
	19,000	11,000	0,04	RNA498	41	NTN			
	19,000	11,800	0,05	RNA22/6LL	41	NTN			
	19,000	11,800	0,05	RNA22/6XLL	41	NTN			
	19,000	23,000	0,09	HKZ10X19X23	47	NTN			
	19,000	32,000	0,09	KR19X	44	NTN			
	20,000	12,000	0,02	RNA0-10X20X12	41	NTN			
	22,000	10,000	0,06	RNA0-10X22X10X	41	NTN			
	22,000	14,000	0,07	NA4900LL	42	NTN			
	22,000	14,000	0,07	NA4900R	42	NTN			
	22,000	16,000	0,09	NK14/16R+1R10X14X16	42	NTN			
	22,000	20,000	0,11	NK14/20R+1R10X14X20	42	NTN			
	22,000	36,000	0,14	KR22	44	NTN			
	22,000	36,000	0,14	KR22C	44	NTN			
	22,000	36,000	0,14	KR22CCLL	44	NTN			
	22,000	36,000	0,14	KR22LL	44	NTN			
	22,000	36,000	0,14	KR22X	44	NTN			
	22,000	36,000	0,14	KR22XCCLL	44	NTN			
	22,000	36,000	0,14	KR22XLL	44	NTN			
	22,000	36,000	0,14	KR22CLL	44	NTN			
	22,000	36,000	0,14	KR2X	44	NTN			
	22,000	36,000	0,14	KRU22LL	44	NTN			
	22,000	36,000	0,06	KRVU22LL	44	NTN			
	23,000	2,000	0,01	AKJ10X23X2	57	NTN			
	24,000	1,000	0,01	AS1100	58	NTN			
	24,000	2,000	0,01	AXK1100	57	NTN			
	24,000	2,750	0,02	GS81100	58	NTN			
	24,000	2,750	0,02	WS81100	58	NTN			
	24,000	2,750	0,01	XS10X24X2.7	58	NTN			
	24,000	23,000	0,08	NKX10	49	NTN			
	24,500	3,800	0,02	ARXJ10X24.5X3.8	59	NTN			
	25,000	6,000	0,02	ARX10X25X6	59	NTN			
	25,000	13,900	0,11	ARX10X25X13.9	59	NTN			
	25,000	23,000	0,12	NKX10Z	49	NTN			
	26,000	36,000	0,18	KR26	44	NTN			
	26,000	36,000	0,12	KR26C	44	NTN			
	26,000	36,000	0,12	KR26CCLL	44	NTN			
	26,000	36,000	0,18	KR26LL	44	NTN			
26,000	36,000	0,18	KR26X	44	NTN				
26,000	36,000	0,12	KR26XCCLL	44	NTN				
26,000	36,000	0,12	KR6CLL	44	NTN				
26,000	36,000	0,18	KRU26LL	44	NTN				
26,000	36,000	0,18	KRV6LL	44	NTN				
26,000	36,000	0,09	KRVU26LL	44	NTN				
27,600	29,500	0,14	HKZ10X27.6X29.5	47	NTN				
30,000	14,000	0,18	NA2200LL	43	NTN				
30,000	14,000	0,12	NA2200XLL	43	NTN				
30,000	15,000	0,19	NATR10	45	NTN				
30,000	15,000	0,19	NATR10LL	45-A	NTN				
30,000	15,000	0,19	NATR10X	45	NTN				

								Brands	
d	D	B	Kg	Reference					
10,000	30,000	15,000	0,06	NATR10XLL	45-A	NTN			
	35,000	42,000	0,23	ARX10X35X42	59	NTN			
	60,000	197,000	3,09	ARX10X60X197	59	NTN			
10,170	15,570	19,800	0,01	KMJ10.1X15.5X19.8	40	NTN			
11,000	14,000	9,800	0,003	K11X14X10	40	NTN			
	14,000	9,800	0,003	K11X14X9.8X	40	NTN			
	14,000	14,000	0,01	1R11X14X14	55	NTN			
	15,000	12,300	0,01	KBK11X15X12.3	40	NTN			
	15,000	15,800	0,02	KBK11X15X15.8	40	NTN			
	16,000	13,000	0,01	HKS11X16X13M	47	NTN			
11,112	25,400	42,800	0,26	CR16X	44	NTN			
	25,400	42,800	0,08	CR16XLL	44	NTN			
	25,400	42,800	0,23	CRV16X	44	NTN			
	25,400	42,800	0,23	CRV16XLL	44	NTN			
	28,575	42,800	0,09	CR18	44	NTN			
	28,575	42,800	0,13	CR18X	44	NTN			
	28,575	42,800	0,23	CRV18XLL	44	NTN			
11,300	16,100	26,300	0,04	KMJ11.3X16.1X26.3	40	NTN			
12,000	15,000	8,800	0,003	K12X15X9	40	NTN			
	15,000	9,800	0,01	K12X15X10	40	NTN			
	15,000	12,000	0,02	1R12X15X12	55	NTN			
	15,000	12,500	0,01	1R12X15X12.5	55	NTN			
	15,000	13,000	0,01	K12X15X13	40	NTN			
	15,000	14,300	0,01	KBK12X15X14.3	40	NTN			
	15,000	16,000	0,02	1R12X15X16	55	NTN			
	15,000	16,400	0,02	KBK12X15X16.6	40	NTN			
	15,000	16,500	0,02	1R12X15X16.5	55	NTN			
	15,000	19,800	0,01	K12X15X20ZW	40	NTN			
	15,000	22,500	0,02	1R12X15X22.5	55	NTN			
	16,000	7,800	0,01	K12X16X8	40	NTN			
	16,000	8,000	0,01	K12X16X8.8	40	NTN			
	16,000	10,000	0,01	BK1210	48	NTN			
	16,000	10,000	0,005	HK1210	47	NTN			
	16,000	10,000	0,01	HK1210D	47	NTN			
	16,000	10,000	0,005	K12X16X10	40	NTN			
	16,000	10,000	0,01	PK12X16X10.2	40	NTN			
	16,000	11,300	0,01	KMJ12X16X11.3	40	NTN			
	16,000	12,000	0,02	1R12X16X12	55	NTN			
	16,000	13,000	0,03	1R12X16X13	55	NTN			
	16,000	14,000	0,03	1R12X16X14	55	NTN			
	16,000	14,800	0,02	KBK12X16X14.8	40	NTN			
	16,000	15,300	0,02	KBK12X16X15.3	40	NTN			
	16,000	15,400	0,02	KBK12X16X15.6	40	NTN			
	16,000	15,800	0,02	KBK12X16X16	40	NTN			
	16,000	16,000	0,03	1R12X16X16	55	NTN			
16,000	16,400	0,02	KBK12X16X16.4	40	NTN				
16,000	19,800	0,03	K12X16X19.8	40	NTN				
16,000	20,000	0,04	1R12X16X20	55	NTN				
16,000	22,000	0,05	1R12X16X22	55	NTN				
17,000	7,800	0,01	K12X17X7.8	40	NTN				
17,000	7,800	0,01	PK12X17X7.8	40	NTN				
17,000	9,800	0,02	K12X17X9.8	40	NTN				
17,000	9,800	0,02	KMJ12X17X9.8	40	NTN				
17,000	9,800	0,02	PK12X17X9.8	40	NTN				
17,000	11,800	0,01	KMJ12X17X11.8	40	NTN				
17,000	12,800	0,02	K12X17X13	40	NTN				
17,000	17,800	0,03	KV12X17X17.8	40	NTN				



								Brands	
d	D	B	Kg	Reference					
12,000	17,000	25,500	0,02	1R12X17X25.5	55	NTN			
	18,000	11,800	0,02	K12X18X12	40	NTN			
	18,000	12,000	0,03	BK1212	48	NTN			
	18,000	12,000	0,01	HK1212	47	NTN			
	18,000	12,000	0,02	HK1212D	47	NTN			
	18,000	14,000	0,03	HK1214L	47	NTN			
	18,000	16,000	0,02	1R12X18X16	55	NTN			
	18,000	16,000	0,04	HK1216LL	47	NTN			
	18,000	20,000	0,02	NK12X18X20	41	NTN			
	19,000	12,000	0,02	HMK1212	47	NTN			
	19,000	12,000	0,03	NK12/12	41	NTN			
	19,000	12,000	0,02	NK12X19X12	41	NTN			
	19,000	14,000	0,01	HMK1214L	47	NTN			
	19,000	15,000	0,03	HMK1215	47	NTN			
	19,000	16,000	0,03	HMK1216LL	47	NTN			
	19,000	16,000	0,02	NK12/16	41	NTN			
	19,000	16,000	0,04	NK12X19X16	41	NTN			
	19,000	20,000	0,05	HMK1220	47	NTN			
	19,000	20,000	0,07	NK12X19X20	41	NTN			
	19,000	25,000	0,07	HMK1225	47	NTN			
	19,000	25,000	0,08	NK12X19X25	41	NTN			
	19,000	28,000	0,05	KH1228	60	NTN			
	19,000	28,000	0,05	KH1228LL	60	NTN			
	19,050	36,500	0,04	CR12H	44	NTN			
	19,050	36,500	0,04	CR12X	44	NTN			
	19,050	36,500	0,04	CR12XH	44	NTN			
	19,050	36,500	0,04	CR14XH	44	NTN			
	20,000	11,000	0,04	RNA499	41	NTN			
	20,000	12,000	0,01	NK12X20X12	41	NTN			
	22,000	12,000	0,06	RNA0-12X22X12	41	NTN			
	23,000	32,000	0,05	K22332LL	40	NTN			
	24,000	2,000	0,01	AKJ12X24X2	57	NTN			
	24,000	4,000	0,02	ARXJ12X24X4	59	NTN			
	24,000	10,000	0,07	RNAB2/8	43-A	NTN			
	24,000	10,000	0,05	RNAB2/8X	43-A	NTN			
	24,000	11,800	0,08	RNA22/8LL	41	NTN			
	24,000	11,800	0,08	RNA22/8XLL	41	NTN			
	24,000	13,000	0,08	NA4901R	42	NTN			
	24,000	13,000	0,05	RNA4901R	41	NTN			
	24,000	14,000	0,08	NA4901LL	42	NTN			
	24,000	16,000	0,10	NK16/16R+1R12X16X16	42	NTN			
	24,000	20,000	0,12	NK16/20R+1R12X16X20	42	NTN			
	24,000	22,000	0,14	NA6901R	42	NTN			
	26,000	1,000	0,01	AS1101	58	NTN			
	26,000	2,000	0,004	AXK1101	57	NTN			
	26,000	2,750	0,02	GS81101	58	NTN			
	26,000	2,750	0,03	WS81101	58	NTN			
	26,000	23,000	0,13	NKX12	49	NTN			
	26,000	36,000	0,18	KR26XLL	44	NTN			
	27,000	23,000	0,13	NKX12Z	49	NTN			
	28,000	12,000	0,08	NA0-12X28X12	42	NTN			
	30,000	40,000	0,09	KR30LL	44	NTN			
	30,000	40,000	0,26	KR30X	44	NTN			
	30,000	40,000	0,17	KR30XLL	44	NTN			
	30,000	40,000	0,09	KRT30LL	44	NTN			
	30,000	40,000	0,17	KRT30XLL	44	NTN			
	30,000	40,000	0,26	KRU30LL	44	NTN			
	30,000	40,000	0,26	KRU30XLL	44	NTN			
	30,000	40,000	0,27	KRV30	44	NTN			
	30,000	40,000	0,27	KRV30X	44	NTN			
30,000	40,000	0,09	KRV30XLL	44	NTN				
30,000	40,000	0,33	KRVT30LL	44	NTN				

								Brands			
d	D	B	Kg	Reference							
12,000	30,000	40,000	0,33	KRVT30XLL	44	NTN					
	30,000	40,000	0,11	KRVU30LL	44	NTN					
	30,000	40,000	0,09	KRVU30XLL	44	NTN					
	30,000	40,000	0,18	NUKR30	51	NTN					
	30,000	40,000	0,09	NUKR30X	51	NTN					
	30,000	40,000	0,09	NUKRT30X	51	NTN					
	32,000	14,000	0,13	NA2201LL	43	NTN					
	32,000	14,000	0,13	NA2201XLL	43	NTN					
	32,000	15,000	0,21	NATR12	45	NTN					
	32,000	15,000	0,20	NATR12LL	45-A	NTN					
	32,000	15,000	0,22	NATR12X	45	NTN					
	32,000	15,000	0,21	NATR12XLL	45-A	NTN					
	32,000	40,000	0,10	KR32XLL	44	NTN					
	32,000	40,000	0,10	KRT32	44	NTN					
	32,000	40,000	0,10	KRT32LL	44	NTN					
	32,000	40,000	0,29	KRU32XLL	44	NTN					
	32,000	40,000	0,45	KRVT32XLL	44	NTN					
	35,000	3,000	0,02	XS12X35X3	58	NTN					
	40,000	24,000	0,19	NATR12X40X24	45	NTN					
	12,700	17,400	19,600	0,03	K12.7X17.4X19.6	40	NTN				
		17,400	22,200	0,03	HKS12.7X17.4X22.2	47	NTN				
		19,050	16,130	0,02	M1-081210	55	NTN				
		19,050	19,300	0,05	M1-081212	55	NTN				
		19,050	25,650	0,06	M1-081216	55	NTN				
		31,750	52,400	0,15	CRV20	44	NTN				
		31,750	52,400	0,15	CRV20XLL	44	NTN				
		34,925	52,400	0,15	CRV22XLL	44	NTN				
		152,400	63,880	9,03	M1-109640	55	NTN				
		12,800	17,600	26,300	0,03	KMJ12.8X17.6X26.3	40	NTN			
13,000		16,000	13,800	0,01	KJ13X16X13.8	40	NTN				
	17,000	18,100	0,02	KBK13X17X18.1	40	NTN					
	19,000	9,800	0,01	PK13X19X9.8X3	40	NTN					
	19,000	12,000	0,01	BK1312	48	NTN					
	19,000	12,000	0,03	HK1312	47	NTN					
	19,000	12,000	0,01	HK1312D	47	NTN					
	19,000	14,000	0,03	HKS13X19X14	47	NTN					
	21,000	12,000	0,04	NK13X21X12	41	NTN					
	25,400	42,800	0,17	CR16	44	NTN					
	25,500	13,000	0,09	NK13X25.5X13N	41	NTN					
	26,000	1,000	0,01	AS13X26X1	58	NTN					
	35,000	3,000	0,04	XS13X35X3	58	NTN					
42,000	3,000	0,08	XS13X42X3	58	NTN						
13,100	29,000	1,530	0,02	XS13.1X29X1.5	58	NTN					
13,500	16,500	8,300	0,004	K13.5X16.5X8.3	40	NTN					
	17,500	10,000	0,02	HKS13.5X17.5X10M	47	NTN					
13,850	18,850	16,300	0,03	KMJ13.8X18.8X16.3	40	NTN					
14,000	17,000	9,800	0,01	K14X17X10	40	NTN					
	17,000	9,800	0,01	KV14X17X10	40	NTN					
	17,000	17,000	0,02	1R14X17X17	55	NTN					
	18,000	9,800	0,02	K14X18X10	40	NTN					
	18,000	10,000	0,01	HKS14X18X10	47	NTN					
	18,000	11,800	0,02	KMJ14X18X11.8	40	NTN					
	18,000	12,800	0,02	K14X18X13	40	NTN					
	18,000	14,000	0,01	HKS14X18X14	47	NTN					
	18,000	14,800	0,02	K14X18X15	40	NTN					

										Brands	
d	D	B	Kg	Reference							
14,000	18,000	15,800	0,02	KBK14X18X15.8	40	NTN					
	18,000	16,800	0,01	GK14X18X16.8	40	NTN					
	18,000	16,800	0,03	K14X18X17	40	NTN					
	18,000	16,800	0,01	KBK14X18X17	40	NTN					
	18,000	17,300	0,03	KBK14X18X17.3	40	NTN					
	18,000	17,800	0,02	KJ14X18X17.8	40	NTN					
	18,000	18,300	0,01	KBK14X18X18.3	40	NTN					
	18,000	18,800	0,02	KBK14X18X18.8	40	NTN					
	18,000	19,800	0,03	KBK14X18X20	40	NTN					
	18,000	38,800	0,02	K14X18X39ZW	40	NTN					
	19,000	7,900	0,005	PK14X19X7.9	40	NTN					
	19,000	9,700	0,01	PK14X19X9.7	40	NTN					
	19,000	11,800	0,02	KMJ14X19X11.8	40	NTN					
	19,000	11,800	0,02	PK14X19X11.8	40	NTN					
	19,000	12,800	0,01	K14X19X13	40	NTN					
	20,000	11,800	0,03	K14X20X12	40	NTN					
	20,000	11,800	0,03	PK14X20X11.8	40	NTN					
	20,000	12,000	0,02	BK1412	48	NTN					
	20,000	12,000	0,03	HK1412	47	NTN					
	20,000	14,000	0,04	HK1414L	47	NTN					
	20,000	16,000	0,04	HK1416	47	NTN					
	20,000	16,000	0,03	HK1416LL	47	NTN					
	20,000	16,800	0,02	K14X20X17	40	NTN					
	20,000	20,000	0,06	HKS14X20X20	47	NTN					
	21,000	9,000	0,01	HKS14X21X9	47	NTN					
	21,000	28,000	0,06	KH1428	60	NTN					
	22,000	10,000	0,01	HKS14X22X10M	47	NTN					
	22,000	12,000	0,04	HKS14X22X12M	47	NTN					
	22,000	13,000	0,04	RNA0-14X22X13	41	NTN					
	22,000	13,000	0,05	RNA4900L	41	NTN					
	22,000	13,000	0,05	RNA4900LL	41	NTN					
	22,000	13,000	0,03	RNA4900R	41	NTN					
	22,000	16,000	0,03	HKS14X22X16M	47	NTN					
	22,000	16,000	0,04	HMK1416	47	NTN					
	22,000	16,000	0,02	NK14/16	41	NTN					
	22,000	16,000	0,06	NK14/16R	41	NTN					
	22,000	19,000	0,02	HMK1419L	47	NTN					
	22,000	20,000	0,07	HMK1420C	47	NTN					
	22,000	20,000	0,03	NK14/20	41	NTN					
	22,000	20,000	0,07	NK14/20R	41	NTN					
	22,000	20,000	0,03	RNA0-14X22X20ZW	41	NTN					
	22,000	22,000	0,02	HMK1422LL	47	NTN					
	24,500	15,000	0,09	NK14X24.5X15N	41	NTN					
	29,000	4,800	0,02	ARX14X29X4.8	59	NTN					
	29,000	5,700	0,05	ARX14X29X5.7	59	NTN					
	29,500	4,870	0,05	ARX14X29.5X4.8	59	NTN					
	30,000	12,000	0,05	RNAB200	43-A	NTN					
30,000	12,000	0,09	RNAB200X	43-A	NTN						
30,000	13,800	0,16	RNA2200LL	41	NTN						
30,000	13,800	0,18	RNA2200XLL	41	NTN						
31,000	3,500	0,05	XS14X31X3.5	58	NTN						
14,288	19,050	19,050	0,01	HKS14.2X19X19	47	NTN					
14,300	19,040	8,800	0,01	KV14.3X19X8.8	40	NTN					
15,000	18,000	8,800	0,01	1R15X18X8.8	55	NTN					
	18,000	12,500	0,02	1R15X18X12.5	55	NTN					
	18,000	13,000	0,01	1R15X18X13	55	NTN					
	18,000	13,800	0,01	K15X18X14	40	NTN					
	18,000	16,000	0,03	1R15X18X16	55	NTN					
	18,000	16,500	0,02	1R15X18X16.5	55	NTN					

										Brands	
d	D	B	Kg	Reference							
15,000	18,000	17,500	0,01	1R15X18X17.5	55	NTN					
	18,000	20,500	0,02	1R15X18X20.5	55	NTN					
	18,000	21,800	0,02	K15X18X21.8ZW	40	NTN					
	18,000	25,500	0,02	1R15X18X25.5	55	NTN					
	19,000	7,800	0,01	KV15X19X7.8	40	NTN					
	19,000	9,800	0,02	K15X19X10	40	NTN					
	19,000	12,800	0,02	K15X19X13	40	NTN					
	19,000	13,500	0,01	1R15X19X13.5	55	NTN					
	19,000	16,000	0,04	1R15X19X16	55	NTN					
	19,000	16,500	0,03	1R15X19X16.5	55	NTN					
	19,000	16,800	0,03	K15X19X17	40	NTN					
	19,000	16,800	0,01	KBK15X19X16.8	40	NTN					
	19,000	17,300	0,03	KBK15X19X17.3	40	NTN					
	19,000	18,800	0,02	KBK15X19X18.8	40	NTN					
	19,000	19,000	0,02	1R15X19X19	55	NTN					
	19,000	19,500	0,01	KBK15X19X19.5	40	NTN					
	19,000	19,800	0,04	KBK15X19X19.8	40	NTN					
	19,000	20,000	0,03	1R15X19X20	55	NTN					
	19,000	23,800	0,04	K15X19X24ZW	40	NTN					
	20,000	9,800	0,02	PK15X20X9.8	40	NTN					
	20,000	11,800	0,01	K15X20X11.8	40	NTN					
	20,000	11,800	0,02	PK15X20X11.8X	40	NTN					
	20,000	12,000	0,04	1R15X20X12	55	NTN					
	20,000	12,800	0,02	K15X20X13	40	NTN					
	20,000	13,000	0,04	1R15X20X13	55	NTN					
	20,000	14,000	0,04	1R15X20X14	55	NTN					
	20,000	15,800	0,03	KMJ15X20X15.8	40	NTN					
	20,000	17,800	0,04	KBK15X20X17.8	40	NTN					
	20,000	18,000	0,04	1R15X20X18	55	NTN					
	20,000	20,500	0,02	1R15X20X20.5	55	NTN					
	20,000	23,000	0,07	1R15X20X23	55	NTN					
	20,000	26,000	0,05	1R15X20X26	55	NTN					
	20,000	30,500	0,03	1R15X20X30.5	55	NTN					
	21,000	9,800	0,02	PK15X21X10	40	NTN					
	21,000	9,800	0,02	PK15X21X9.8	40	NTN					
	21,000	11,800	0,02	PK15X21X11.8	40	NTN					
	21,000	12,000	0,04	BK1512	48	NTN					
	21,000	12,000	0,02	HK1512	47	NTN					
	21,000	12,000	0,03	HK1512D	47	NTN					
	21,000	14,000	0,04	HK1514L	47	NTN					
	21,000	14,800	0,04	K15X21X15	40	NTN					
	21,000	15,500	0,04	BKS15X21X15.5	48	NTN					
	21,000	16,000	0,03	BK1516	48	NTN					
	21,000	16,000	0,02	HK1516	47	NTN					
	21,000	16,000	0,04	HK1516D	47	NTN					
	21,000	16,000	0,01	HK1516LL	47	NTN					
	21,000	16,000	0,03	HK1516LLD	47	NTN					
	21,000	16,800	0,01	KMJ15X21X16.8	40	NTN					
	21,000	16,800	0,04	KMJ15X21X17	40	NTN					
	21,000	20,800	0,04	K15X21X21	40	NTN					
	21,000	22,000	0,06	HK1522ZWD	47	NTN					
	22,000	10,000	0,03	HMK1510	47	NTN					
	22,000	12,000	0,03	HMK1512	47	NTN					
	22,000	13,000	0,03	HMK1513L	47	NTN					
	22,000	15,000	0,02	HMK1515C	47	NTN					
	22,000	16,000	0,03	HMK1516LL	47	NTN					
	22,000	18,000	0,02	HMK1518L	47	NTN					
22,000	20,000	0,06	1R15X22X20	55	NTN						
22,000	20,000	0,04	HMK1520	47	NTN						
22,000	21,000	0,06	HMK1521LL	47	NTN						
22,000	25,000	0,03	HMK1525	47	NTN						
23,000	13,000	0,04	RNA0-15X23X13	41	NTN						



								Brands		
d	D	B	Kg	Reference						
15,000	23,000	16,000	0,02	NK15/16R	41	NTN				
	23,000	16,000	0,06	NK15X23X16	41	NTN				
	23,000	20,000	0,08	NK15/20R	41	NTN				
	23,000	20,000	0,05	NK15X23X12	41	NTN				
	24,000	13,000	0,05	HKS15X24X13M	47	NTN				
	24,000	17,000	0,05	HKS15X24X17M	47	NTN				
	24,000	23,000	0,13	NKXR15	50	NTN				
	24,000	23,000	0,15	NKXR15Z	50	NTN				
	25,000	17,000	0,10	NK15X25X17N	41	NTN				
	27,000	16,000	0,11	NK19/16R+1R15X19X16	42	NTN				
	27,000	19,000	0,04	NK19/16R+1R15X19X19	42	NTN				
	27,000	20,000	0,14	NK19/20R+1R15X19X20	42	NTN				
	28,000	1,000	0,01	AS1102	58	NTN				
	28,000	2,000	0,01	AXK1102	57	NTN				
	28,000	2,750	0,02	WS81102	58	NTN				
	28,000	3,500	0,01	K81102	57	NTN				
	28,000	9,000	0,06	81102	56	NTN				
	28,000	13,000	0,10	NA4902R	42	NTN				
	28,000	14,000	0,08	NA4902LL	42	NTN				
	28,000	18,000	0,15	NK1A5902A	53	NTN				
	28,000	23,000	0,19	NA6902R	42	NTN				
	28,000	23,000	0,14	NKX15	49	NTN				
	29,000	23,000	0,14	NKX15Z	49	NTN				
	30,000	12,000	0,06	ARX15X30X12	59	NTN				
	30,000	40,000	0,26	KR30	44	NTN				
	30,000	40,000	0,27	KRV30LL	44	NTN				
	32,000	40,000	0,29	KR32	44	NTN				
	32,000	40,000	0,29	KR32LL	44	NTN				
	32,000	40,000	0,19	KR32X	44	NTN				
	32,000	40,000	0,30	KRV32	44	NTN				
	32,000	40,000	0,30	KRV32LL	44	NTN				
	32,000	40,000	0,30	KRV32X	44	NTN				
	32,000	40,000	0,20	KRV32XLL	44	NTN				
	35,000	14,000	0,23	NA2202LL	43	NTN				
	35,000	19,000	0,32	NATR15	45	NTN				
	35,000	19,000	0,30	NATR15LL	45-A	NTN				
	35,000	19,000	0,32	NATR15X	45	NTN				
	35,000	19,000	0,10	NATR15XLL	45-A	NTN				
	35,000	19,000	0,10	NUTR202	52	NTN				
	35,000	19,000	0,30	NUTR202X	52	NTN				
	35,000	52,000	0,51	KR35	44	NTN				
	35,000	52,000	0,51	KR35LL	44	NTN				
	42,000	19,000	0,45	NUTR302	52	NTN				
	42,000	19,000	0,48	NUTR302X	52	NTN				
	58,000	77,000	1,09	ARX15X58X77	59	NTN				
	15,875	20,638	14,270	0,02	HKS15.8X20.6X14.2	47	NTN			
		20,638	15,880	0,02	HKS15.8X20.6X15.8	47	NTN			
		20,650	17,200	0,03	PK15.8X20.6X17.2	40	NTN			
		22,225	12,950	0,02	M1-101408	55	NTN			
		22,225	19,300	0,06	M1-101412	55	NTN			
22,225		25,650	0,04	M1-101416	55	NTN				
28,575		19,050	0,14	MR101812	41	NTN				
28,575		25,400	0,19	MR101816	41	NTN				
38,100		61,900	0,24	CR24	44	NTN				
38,100		61,900	0,24	CR24X	44	NTN				
38,100		61,900	0,78	CRV24LL	44	NTN				
38,100		61,900	0,78	CRV24X	44	NTN				
38,100		61,900	0,78	CRV24XLL	44	NTN				
41,275		61,900	0,56	CRV26XLL	44	NTN				
15,900		20,640	8,800	0,01	KV15.9X20.6X8.8	40	NTN			

								Brands	
d	D	B	Kg	Reference					
16,000	19,000	14,000	0,03	1R16X19X14	55	NTN			
	20,000	7,800	0,03	K16X20X7.8	40	NTN			
	20,000	9,800	0,02	K16X20X10	40	NTN			
	20,000	10,800	0,01	K16X20X11	40	NTN			
	20,000	12,800	0,02	K16X20X13	40	NTN			
	20,000	13,000	0,03	1R16X20X13	55	NTN			
	20,000	16,000	0,04	1R16X20X16	55	NTN			
	20,000	16,800	0,03	K16X20X17	40	NTN			
	20,000	16,800	0,03	KBK16X20X17	40	NTN			
	20,000	16,800	0,02	KJ16X20X17	40	NTN			
	20,000	17,300	0,03	KBK16X20X17.3	40	NTN			
	20,000	17,800	0,03	KBK16X20X17.8	40	NTN			
	20,000	18,800	0,01	KBK16X20X18.8	40	NTN			
	20,000	19,600	0,01	KBK16X20X19.8	40	NTN			
	20,000	22,800	0,01	KBK16X20X22.8	40	NTN			
	21,000	12,800	0,01	PK16X21X12.8	40	NTN			
	21,000	19,600	0,05	KBK16X21X19.6	40	NTN			
	22,000	11,800	0,03	K16X22X12	40	NTN			
	22,000	11,800	0,04	KMJ16X22X11.8	40	NTN			
	22,000	11,800	0,02	PK16X22X11.8	40	NTN			
	22,000	12,000	0,04	BK1612	48	NTN			
	22,000	12,000	0,01	HK1612	47	NTN			
	22,000	12,000	0,03	HK1612D	47	NTN			
	22,000	12,800	0,03	KMJ16X22X13	40	NTN			
	22,000	14,000	0,04	HK1614L	47	NTN			
	22,000	15,800	0,03	K16X22X15.8	40	NTN			
	22,000	15,800	0,02	KMJ16X22X16	40	NTN			
	22,000	16,000	0,02	BK1616	48	NTN			
	22,000	16,000	0,02	HK1616	47	NTN			
	22,000	16,000	0,05	HK1616D	47	NTN			
	22,000	16,000	0,01	HK1616LL	47	NTN			
	22,000	16,800	0,02	K16X22X17	40	NTN			
	22,000	16,800	0,03	PK16X22X16.8	40	NTN			
	22,000	19,800	0,05	K16X22X20	40	NTN			
	22,000	20,000	0,06	NK16X22X20	41	NTN			
	22,000	22,000	0,05	BK1622ZWD	48	NTN			
	22,000	22,000	0,04	HK1622ZWD	47	NTN			
	23,000	11,800	0,04	PK16X23X11.8	40	NTN			
	23,000	13,800	0,01	KMJ16X23X13.8	40	NTN			
	23,000	16,000	0,05	NK16X23X16	41	NTN			
	23,000	22,000	0,08	NK16X23X22	41	NTN			
	24,000	8,000	0,04	RNA0-16X24X8X	41	NTN			
	24,000	13,000	0,06	RNA0-16X24X13	41	NTN			
	24,000	13,000	0,02	RNA4901L	41	NTN			
	24,000	13,000	0,07	RNA4901LL	41	NTN			
	24,000	16,000	0,06	HMK1616	47	NTN			
	24,000	16,000	0,05	NK16/16	41	NTN			
	24,000	16,000	0,07	NK16/16R	41	NTN			
	24,000	19,800	0,05	K16X24X19.8	40	NTN			
	24,000	20,000	0,03	HMK1620	47	NTN			
24,000	20,000	0,08	NK16/20R	41	NTN				
24,000	20,000	0,07	RNA0-16X24X20ZW	41	NTN				
24,000	22,000	0,06	NK16X24X22	41	NTN				
24,000	22,000	0,09	RNA6901R	41	NTN				
24,000	26,000	0,06	HMK1626LL	47	NTN				
24,000	30,000	0,08	KH1630	60	NTN				
24,000	30,000	0,08	KH1630LL	60	NTN				
24,500	1,000	0,004	AS16X24.5X1	58	NTN				
26,000	13,000	0,08	NK16X26X13N	41	NTN				
28,000	2,750	0,02	GS81102	58	NTN				
28,000	3,000	0,01	XS16X28X3	58	NTN				
28,000	12,000	0,03	RNA0-16X28X12	41	NTN				

								Brands		
d	D	B	Kg	Reference						
16,000	28,000	13,000	0,10	RNA4902R+1R16X20X13X	41	NTN				
	29,000	1,000	0,01	AS16X29X1	58	NTN				
	31,750	52,400	0,30	CR20	44	NTN				
	31,750	52,400	0,32	CR20X	44	NTN				
	32,000	12,000	0,10	RNAB201	43-A	NTN				
	32,000	12,000	0,05	RNAB201X	43-A	NTN				
	32,000	13,800	0,17	RNA2201LL	41	NTN				
	34,925	52,400	0,17	CR22	44	NTN				
	35,000	50,000	0,17	KRU35	44	NTN				
	35,000	52,000	0,34	KR35XLL	44	NTN				
	35,000	52,000	0,21	KRT35	44	NTN				
	35,000	52,000	0,21	KRT35LL	44	NTN				
	35,000	52,000	0,21	KRT35XLL	44	NTN				
	35,000	52,000	0,51	KRU35LL	44	NTN				
	35,000	52,000	0,34	KRU35XLL	44	NTN				
	35,000	52,000	0,52	KRVT35LL	44	NTN				
	35,000	52,000	0,17	KRVT35X	44	NTN				
	35,000	52,000	0,52	KRVT35XLL	44	NTN				
	35,000	52,000	0,17	KRVU35LL	44	NTN				
	35,000	52,000	0,17	KRVU35XLL	44	NTN				
	35,000	52,000	0,17	NUKR35	51	NTN				
	35,000	52,000	0,17	NUKR35X	51	NTN				
	35,000	52,000	0,20	NUKRT35	51	NTN				
	17,000	20,000	8,800	0,004	K17X20X8.8	40	NTN			
		20,000	16,000	0,03	1R17X20X16	55	NTN			
		20,000	16,500	0,03	1R17X20X16.5	55	NTN			
		20,000	20,000	0,03	1R17X20X20	55	NTN			
		20,000	20,500	0,03	1R17X20X20.5	55	NTN			
		20,000	30,500	0,06	1R17X20X30.5	55	NTN			
		21,000	9,800	0,02	K17X21X10	40	NTN			
21,000		12,800	0,03	K17X21X13	40	NTN				
21,000		14,800	0,03	K17X21X15	40	NTN				
21,000		16,000	0,04	1R17X21X16	55	NTN				
21,000		16,800	0,03	K17X21X17	40	NTN				
21,000		20,000	0,03	1R17X21X20	55	NTN				
21,000		25,000	0,03	KBK17X21X25	40	NTN				
22,000		11,000	0,01	1R17X22X11	55	NTN				
22,000		12,600	0,03	KMJ17X22X12.6	40	NTN				
22,000		13,000	0,05	1R17X22X13	55	NTN				
22,000		14,000	0,05	1R17X22X14	55	NTN				
22,000		14,100	0,03	KMJ17X22X14.1	40	NTN				
22,000		15,800	0,04	K17X22X15.8	40	NTN				
22,000		16,000	0,04	1R17X22X16	55	NTN				
22,000		18,000	0,06	1R17X22X18	55	NTN				
22,000		19,800	0,05	K17X22X20	40	NTN				
22,000		20,500	0,05	1R17X22X20.5	55	NTN				
22,000		21,800	0,03	GK17X22X21.8	40	NTN				
22,000		22,000	0,04	KBK17X22X22	40	NTN				
22,000		23,000	0,08	1R17X22X23	55	NTN				
22,000		26,000	0,06	1R17X22X26	55	NTN				
22,000		32,000	0,04	1R17X22X32	55	NTN				
23,000		9,800	0,01	K17X23X9.8	40	NTN				
23,000		12,000	0,01	HK1712	47	NTN				
23,000	12,000	0,01	HK1712D	47	NTN					
23,000	13,800	0,04	K17X23X13.8	40	NTN					
23,000	14,800	0,05	K17X23X14.8	40	NTN					
23,000	22,800	0,04	K17X23X22.8	40	NTN					
23,800	31,600	0,12	BKS17X23.8X31.6	48	NTN					
23,862	22,100	0,04	BKS17X23.8X22.1	48	NTN					
24,000	14,500	0,01	KMJ17X24X14.5	40	NTN					
24,000	15,000	0,05	HMK1715	47	NTN					

								Brands	
d	D	B	Kg	Reference					
17,000	24,000	18,000	0,02	HMK1718L	47	NTN			
	24,000	20,000	0,07	1R17X24X20	55	NTN			
	24,000	20,000	0,07	HMK1720C	47	NTN			
	24,000	21,000	0,07	HMK1721LL	47	NTN			
	25,000	13,000	0,02	RNA0-17X25X13	41	NTN			
	25,000	13,800	0,06	K17X25X13.8	40	NTN			
	25,000	15,000	0,06	HKS17X25X15	47	NTN			
	25,000	16,000	0,07	NK17/16R	41	NTN			
	25,000	18,000	0,07	HKS17X25X18	47	NTN			
	25,000	20,000	0,08	HKS17X25X20	47	NTN			
	25,000	20,000	0,09	NK17/20R	41	NTN			
	25,000	26,000	0,04	RNA0-17X25X26ZW	41	NTN			
	26,000	20,000	0,10	NK21/20R+1R17X21X20	42	NTN			
	26,000	25,000	0,11	NKXR17	50	NTN			
	26,000	25,000	0,17	NKXR17Z	50	NTN			
	27,000	14,800	0,07	PK17X27X14.8	40	NTN			
	29,000	16,000	0,12	NK21/16R+1R17X21X16	42	NTN			
	30,000	1,000	0,01	AS1103	58	NTN			
	30,000	2,000	0,01	AXK1103	57	NTN			
	30,000	2,750	0,03	WS81103	58	NTN			
	30,000	3,500	0,01	K81103	57	NTN			
	30,000	9,000	0,07	81103	56	NTN			
	30,000	13,000	0,12	NA4903LL	42	NTN			
	30,000	13,000	0,12	NA4903R	42	NTN			
	30,000	13,000	0,03	RNA4903	41	NTN			
	30,000	18,000	0,16	NA5903	42	NTN			
	30,000	18,000	0,17	NK1A5903A	53	NTN			
	30,000	23,000	0,20	NA6903R	42	NTN			
	30,000	25,000	0,16	NKX17	49	NTN			
	30,000	25,000	0,17	NKX17Z	49	NTN			
	30,000	27,500	0,03	XS17X30X2.7	58	NTN			
	33,000	1,000	0,01	AS17X33X1	58	NTN			
	33,000	2,000	0,01	AKJ17X33X2	57	NTN			
	40,000	16,000	0,34	NA2203LL	43	NTN			
	40,000	16,000	0,34	NA2203XLL	43	NTN			
	40,000	21,000	0,46	NATR17	45	NTN			
	40,000	21,000	0,29	NATR17LL	45-A	NTN			
	40,000	21,000	0,31	NATR17X	45	NTN			
	40,000	21,000	0,29	NATR17XLL	45-A	NTN			
	40,000	21,000	0,15	NUTR203	52	NTN			
40,000	21,000	0,44	NUTR203X	52	NTN				
42,000	3,000	0,03	XS17X42X3	58	NTN				
47,000	21,000	0,22	NUTR303	52	NTN				
47,000	21,000	0,67	NUTR303X	52	NTN				
70,000	106,000	4,55	ARX17X70X106	59	NTN				
17,500	22,000	15,800	0,03	K17.5X22X15.8	40	NTN			
	30,000	1,500	0,02	XS17.5X30X1.5	58	NTN			
17,700	30,000	17,000	0,08	NK17.7X30X17	41	NTN			
18,000	22,000	9,800	0,01	K18X22X10	40	NTN			
	22,000	12,800	0,03	K18X22X13	40	NTN			
	22,000	16,800	0,03	K18X22X17	40	NTN			
	22,000	19,000	0,04	1R18X22X19	55	NTN			
	22,000	21,800	0,05	KBK18X22X21.8	40	NTN			
	22,000	22,800	0,05	KBK18X22X22.8	40	NTN			
	22,000	23,800	0,05	KBK18X22X23.8	40	NTN			
	23,000	12,000	0,03	HK1812	47	NTN			
	23,000	19,800	0,02	K18X23X20	40	NTN			
	24,000	11,600	0,03	PK18X24X11.6	40	NTN			
24,000	11,800	0,04	K18X24X12	40	NTN				



								Brands	
d	D	B	Kg	Reference					
18,000	24,000	11,800	0,03	PK18X24X11.8	40	NTN			
	24,000	12,000	0,02	BK1812	48	NTN			
	24,000	12,600	0,04	KMJ18X24X12.6	40	NTN			
	24,000	12,800	0,01	K18X24X13	40	NTN			
	24,000	13,000	0,03	K18X24X14.8	40	NTN			
	24,000	13,200	0,01	PK18X24X13.2	40	NTN			
	24,000	13,300	0,02	PK18X24X13.3	40	NTN			
	24,000	14,000	0,01	HK1814L	47	NTN			
	24,000	14,100	0,03	KMJ18X24X14.1	40	NTN			
	24,000	16,000	0,02	HK1816	47	NTN			
	24,000	16,000	0,03	HK1816D	47	NTN			
	24,000	16,000	0,03	HK1816F	47	NTN			
	24,000	16,000	0,03	HK1816LL	47	NTN			
	24,000	16,800	0,04	KMJ18X24X17	40	NTN			
	24,000	19,800	0,06	K18X24X20	40	NTN			
	25,000	12,000	0,05	NK18X25X12	41	NTN			
	25,000	13,000	0,02	HMK1813	47	NTN			
	25,000	15,000	0,02	HMK1815	47	NTN			
	25,000	16,000	0,05	NK18X25X16	41	NTN			
	25,000	16,800	0,04	K18X25X17	40	NTN			
	25,000	17,000	0,04	HMK1817	47	NTN			
	25,000	19,000	0,02	HMK1819	47	NTN			
	25,000	20,000	0,05	HMK1820	47	NTN			
	25,000	20,000	0,02	HMK1820L	47	NTN			
	25,000	21,000	0,02	HMK1821LL	47	NTN			
	25,000	21,800	0,05	K18X25X22	40	NTN			
	25,000	21,800	0,04	K8X25X21.8	40	NTN			
	25,000	23,000	0,09	1R18X25X23	55	NTN			
	25,000	25,000	0,06	HMK1825	47	NTN			
	26,000	16,000	0,07	NK18/16R	41	NTN			
	26,000	20,000	0,09	NK18/20R	41	NTN			
	26,000	20,000	0,02	RNA0-18X26X13	41	NTN			
	26,000	23,000	0,09	KDX18X26X23	61	NTN			
	27,000	13,000	0,06	NK18X27X13	41	NTN			
	27,000	23,800	0,12	PK18X27X23.8	40	NTN			
	27,000	26,800	0,14	PK18X27X26.8	40	NTN			
	28,000	20,000	0,12	NK18X28X20	41	NTN			
	29,000	14,000	0,11	NK18X29X14	41	NTN			
	30,000	2,750	0,03	GS81103	58	NTN			
	30,000	12,000	0,11	RNA0-18X30X12	41	NTN			
	30,000	24,000	0,07	RNA0-18X30X24ZW	41	NTN			
	31,000	1,000	0,01	AS18X31X1	58	NTN			
	34,600	5,400	0,02	ARXJ18X34.6X5.4	59	NTN			
	34,600	6,200	0,01	ARXJ18X34.6X6.2	59	NTN			
	35,000	5,400	0,03	ARXJ18X35X5.4	59	NTN			
	35,000	6,200	0,01	ARXJ18X35X6.2	59	NTN			
	35,000	52,000	0,51	KR35X	44	NTN			
	35,000	52,000	0,34	KRV35	44	NTN			
	35,000	52,000	0,52	KRV35LL	44	NTN			
	35,000	52,000	0,40	KRV35X	44	NTN			
	35,000	52,000	0,40	KRV35XLL	44	NTN			
	35,400	5,400	0,03	ARXJ18X35.4X5.4	59	NTN			
	35,400	6,200	0,02	ARXJ18X35.4X6.2	59	NTN			
	35,800	5,400	0,01	ARXJ18X35.8X5.4	59	NTN			
	38,900	6,600	0,07	ARXJ18X38.9X6.6	59	NTN			
	40,000	58,000	0,74	KR40	44	NTN			
	40,000	58,000	0,25	KR40LL	44	NTN			
	40,000	58,000	0,74	KR40X	44	NTN			
	40,000	58,000	0,25	KR40XLL	44	NTN			
	40,000	58,000	0,25	KRT40	44	NTN			
40,000	58,000	0,25	KRT40LL	44	NTN				
40,000	58,000	0,25	KRT40XLL	44	NTN				

								Brands		
d	D	B	Kg	Reference						
18,000	40,000	58,000	0,74	KRU40LL	44	NTN				
	40,000	58,000	0,76	KRV40	44	NTN				
	40,000	58,000	0,76	KRV40LL	44	NTN				
	40,000	58,000	0,89	KRV40XLL	44	NTN				
	40,000	58,000	0,50	KRVU40XLL	44	NTN				
	40,000	58,000	0,48	NUKR40	51	NTN				
	40,000	58,000	0,48	NUKRT40	51	NTN				
	40,000	58,000	0,48	NUKRT40X	51	NTN				
	40,000	58,000	0,24	NUKR40	51	NTN				
	44,000	3,000	0,08	XS18X44X3	58	NTN				
	18,600	25,600	16,300	0,02	KMJ18.6X25.6X16.3	40	NTN			
	19,000	22,000	9,800	0,01	K19X22X9.8	40	NTN			
		23,000	12,800	0,03	K19X23X13	40	NTN			
		23,000	16,800	0,01	K19X23X17	40	NTN			
23,000		16,800	0,01	KV19X23X17	40	NTN				
23,000		21,800	0,03	KBK19X23X21.8	40	NTN				
24,000		13,900	0,02	PK19X24X13.9	40	NTN				
24,000		22,000	0,06	K19X24X22	40	NTN				
24,000		25,500	0,04	K19X24X25.5	40	NTN				
25,000		15,800	0,02	PK19X25X15.8	40	NTN				
25,000		19,200	0,05	KMJ19X25X19.2	40	NTN				
25,000		22,200	0,04	KMJ19X25X22.2	40	NTN				
25,000		22,800	0,04	PK19X25X22.8	40	NTN				
25,400		15,800	0,03	HKS19X25.4X15.8	47	NTN				
27,000		16,000	0,05	HMK1916	47	NTN				
27,000		16,000	0,08	NK19/16R	41	NTN				
27,000		17,000	0,08	BKS19X27X17	48	NTN				
27,000		19,000	0,05	HMK1919L	47	NTN				
27,000		20,000	0,03	HMK1920	47	NTN				
27,000		20,000	0,09	NK19/20R	41	NTN				
27,000		20,800	0,03	PK19X27X20.8	40	NTN				
34,000		18,000	0,18	NK19X34X18N	41	NTN				
35,000		20,000	0,25	NK19X35X20N	41	NTN				
19,050		25,400	19,300	0,07	M1-121612	55	NTN			
		25,400	25,650	0,13	M1-121616	55	NTN			
	31,750	19,050	0,16	MR122012	41	NTN				
	31,750	25,400	0,14	MR122016	41	NTN				
	44,450	71,400	0,65	CRV28XLL	44	NTN				
19,100	50,000	8,400	0,07	ARX19.1X50X8.4	59	NTN				
19,220	22,220	5,800	0,005	K19.2X22.2X5.8	40	NTN				
20,000	24,000	9,600	0,02	K20X24X9.6	40	NTN				
	24,000	9,800	0,02	K20X24X10	40	NTN				
	24,000	10,000	0,01	1R20X24X10	55	NTN				
	24,000	10,600	0,02	K20X24X10.6	40	NTN				
	24,000	10,800	0,02	K20X24X11	40	NTN				
	24,000	12,800	0,03	K20X24X13	40	NTN				
	24,000	16,000	0,05	1R20X24X16	55	NTN				
	24,000	16,800	0,02	K20X24X16.8	40	NTN				
	24,000	16,800	0,04	K20X24X17	40	NTN				
	24,000	20,000	0,06	1R20X24X20	55	NTN				
	24,000	21,400	0,02	1R20X24X21.4	55	NTN				
	24,000	28,500	0,03	1R20X24X28.5	55	NTN				
	25,000	12,500	0,03	1R20X25X12.5	55	NTN				
	25,000	14,000	0,06	1R20X25X14	55	NTN				
	25,000	15,500	0,06	1R20X25X15.5	55	NTN				
	25,000	16,000	0,07	1R20X25X16	55	NTN				

								Brands	
d	D	B	Kg	Reference					
20,000	25,000	16,500	0,02	1R20X25X16.5	55	NTN			
	25,000	17,000	0,07	1R20X25X17	55	NTN			
	25,000	18,000	0,07	1R20X25X18	55	NTN			
	25,000	18,800	0,04	KJ20X25X18.8	40	NTN			
	25,000	20,000	0,08	1R20X25X20	55	NTN			
	25,000	20,500	0,08	1R20X25X20.5	55	NTN			
	25,000	23,000	0,06	1R20X25X23	55	NTN			
	25,000	24,100	0,03	1R20X25X24.1	55	NTN			
	25,000	26,000	0,07	1R20X25X26	55	NTN			
	25,000	26,300	0,05	K20X25X26.3	40	NTN			
	25,000	26,500	0,11	1R20X25X26.5	55	NTN			
	25,000	29,000	0,03	KBK20X25X29	40	NTN			
	25,000	30,000	0,12	1R20X25X30	55	NTN			
	25,000	32,000	0,09	1R20X25X32	55	NTN			
	25,000	38,500	0,16	1R20X25X38.5	55	NTN			
	26,000	11,800	0,04	K20X26X12	40	NTN			
	26,000	11,800	0,04	KMJ20X26X11.8	40	NTN			
	26,000	12,000	0,01	HK2012	47	NTN			
	26,000	12,800	0,03	K20X26X13	40	NTN			
	26,000	12,800	0,04	KMJ20X26X13	40	NTN			
	26,000	12,800	0,01	PK20X26X12.8	40	NTN			
	26,000	13,800	0,02	H20X26X13.8	40	NTN			
	26,000	13,800	0,04	KMJ20X26X13.8	40	NTN			
	26,000	13,800	0,03	PK20X26X13.8	40	NTN			
	26,000	13,800	0,02	PK20X26X16.8	40	NTN			
	26,000	15,100	0,04	KMJ20X26X15.1	40	NTN			
	26,000	16,000	0,07	BK2016	48	NTN			
	26,000	16,000	0,05	HK2016	47	NTN			
	26,000	16,000	0,06	HK2016D	47	NTN			
	26,000	16,000	0,05	HK2016LL	47	NTN			
	26,000	16,700	0,05	PK20X26X16.7	40	NTN			
	26,000	16,800	0,05	KMJ20X26X17	40	NTN			
	26,000	17,000	0,04	GK20X26X17	40	NTN			
	26,000	18,000	0,02	HK2018L	47	NTN			
	26,000	18,200	0,04	KV20X26X18.2	40	NTN			
	26,000	19,800	0,07	K20X26X20	40	NTN			
	26,000	19,800	0,06	KMJ20X26X20	40	NTN			
	26,000	19,800	0,02	PK20X26X19.8	40	NTN			
	26,000	20,000	0,05	BK2020	48	NTN			
	26,000	20,000	0,05	HK2020	47	NTN			
	26,000	20,000	0,07	HK2020D	47	NTN			
	26,000	20,000	0,05	HK2020LL	47	NTN			
	26,000	20,000	0,02	HK2020LLD	47	NTN			
	26,000	20,800	0,06	KJ20X26X20.8	40	NTN			
	26,000	20,800	0,02	PK20X26X20.8	40	NTN			
	26,000	23,800	0,02	KJ20X26X23.8	40	NTN			
	26,000	29,800	0,08	KJ20X26X29.8	40	NTN			
	26,000	30,000	0,04	BK2030ZWD	48	NTN			
	26,000	30,000	0,11	HK2030ZWD	47	NTN			
	27,000	15,000	0,02	HMK2015	47	NTN			
	27,000	17,000	0,07	PK20X27X17	40	NTN			
	27,000	18,000	0,07	HMK2018L	47	NTN			
	27,000	20,000	0,08	HMK2020	47	NTN			
	27,000	21,000	0,02	HMK2021LL	47	NTN			
	27,000	23,000	0,03	HMK2023L	47	NTN			
27,000	25,000	0,10	HMK2025	47	NTN				
27,000	25,000	0,10	HMK2025C	47	NTN				
27,000	26,000	0,07	HMK2026LL	47	NTN				
27,000	30,000	0,12	HMK2030	47	NTN				
28,000	12,800	0,04	PK20X28X12.8	40	NTN				
28,000	13,000	0,08	RNA0-20X28X13	41	NTN				
28,000	13,000	0,05	RNA4902	41	NTN				

								Brands	
d	D	B	Kg	Reference					
20,000	28,000	13,000	0,07	RNA4902L	41	NTN			
	28,000	13,000	0,07	RNA4902LL	41	NTN			
	28,000	13,800	0,02	PK20X28X13.8	40	NTN			
	28,000	15,800	0,02	PK20X28X15.8	40	NTN			
	28,000	16,000	0,08	NK20/16R	41	NTN			
	28,000	16,800	0,07	KMJ20X28X16.8	40	NTN			
	28,000	18,500	0,07	KMJ20X28X18.5	40	NTN			
	28,000	19,800	0,08	KMJ20X28X19.8	40	NTN			
	28,000	20,000	0,14	1R20X28X20	55	NTN			
	28,000	20,000	0,03	BKS20X28X20	48	NTN			
	28,000	20,000	0,10	NK20/20R	41	NTN			
	28,000	23,000	0,11	RNA6902R	41	NTN			
	28,000	26,000	0,15	RNA0-20X28X26ZW	41	NTN			
	28,000	30,000	0,10	KH2030	60	NTN			
	28,000	30,000	0,10	KH2030LL	60	NTN			
	29,000	15,100	0,05	PK20X29X15.1	40	NTN			
	29,000	18,000	0,09	HKS20X29X18	47	NTN			
	30,000	15,000	0,12	NK20X30X15	41	NTN			
	30,000	15,000	0,15	NK20X30X15N	41	NTN			
	30,000	21,800	0,13	PK20X30X21.8	40	NTN			
	30,000	30,000	0,25	NKXR20	50	NTN			
	30,000	30,000	0,26	NKXR20Z	50	NTN			
	32,000	12,000	0,04	RNA0-20X32X12	41	NTN			
	32,000	13,000	0,08	NK20X32X13	41	NTN			
	32,000	14,000	0,08	NK20X32X14	41	NTN			
	32,000	16,000	0,14	NK24/16R+1R20X24X16	42	NTN			
	32,000	20,000	0,18	NK24/20R+1R20X24X20	42	NTN			
	32,000	20,000	0,12	NKS20	41	NTN			
	32,000	24,000	0,08	RNA0-20X32X24ZW	41	NTN			
	32,000	32,300	0,24	K20X32X32.3	40	NTN			
	32,000	45,000	0,20	KD203245	61	NTN			
	32,000	45,000	0,11	KD203245LL	61	NTN			
	33,000	12,000	0,08	NK20X33X12	41	NTN			
	33,000	15,000	0,15	NK20X33X15N	41	NTN			
	34,000	16,000	0,05	NK20X34X16	41	NTN			
	34,000	18,000	0,20	NK20X34X18	41	NTN			
	35,000	1,000	0,01	AS1104	58	NTN			
	35,000	2,000	0,02	AXK1104	57	NTN			
	35,000	2,750	0,04	WS81104	58	NTN			
	35,000	2,750	0,03	XS20X35X2.7	58	NTN			
	35,000	2,800	0,02	ARXJ20X35X2.8	59	NTN			
	35,000	7,500	0,06	ARX20X35X7.5	59	NTN			
	35,000	10,000	0,04	81104	56	NTN			
	35,000	12,000	0,10	RNAB202	43-A	NTN			
	35,000	12,000	0,16	RNAB202X	43-A	NTN			
	35,000	13,800	0,19	RNA2202LL	41	NTN			
	35,000	13,800	0,13	RNA2202XLL	41	NTN			
	35,000	17,000	0,08	NA0-20X35X17	42	NTN			
	35,000	30,000	0,26	NKX20	49	NTN			
	35,000	30,000	0,26	NKX20Z	49	NTN			
	35,000	45,000	0,02	K81104	57	NTN			
	36,000	6,000	0,07	ARX20X36X6	59	NTN			
	37,000	17,000	0,26	NA4904LL	42	NTN			
	37,000	17,000	0,27	NA4904R	42	NTN			
	37,000	23,000	0,31	NA5904	42	NTN			
37,000	23,000	0,33	NK1A5904A	53	NTN				
37,000	30,000	0,40	NA6904R	42	NTN				
38,700	2,800	0,03	ARXJ20X38.7X2.8	59	NTN				
45,000	25,000	0,44	NATR20X45X25	45	NTN				
47,000	18,000	0,54	NA2204LL	43	NTN				
47,000	18,000	0,36	NA2204XLL	43	NTN				
47,000	25,000	0,75	NATR20	45	NTN				



								Brands	
d	D	B	Kg	Reference					
20,000	47,000	25,000	0,48	NATR20LL	45-A	NTN			
	47,000	25,000	0,75	NATR20X	45	NTN			
	47,000	25,000	0,24	NATR20X47X25	45	NTN			
	47,000	25,000	0,48	NATR20XLL	45-A	NTN			
	47,000	25,000	0,73	NUTR204	52	NTN			
	47,000	25,000	0,73	NUTR204X	52	NTN			
	47,000	66,000	1,38	KR47	44	NTN			
	47,000	66,000	1,16	KR47LL	44	NTN			
	47,000	66,000	1,38	KR47X	44	NTN			
	47,000	66,000	0,39	KR47XLL	44	NTN			
	47,000	66,000	0,39	KRT47LL	44	NTN			
	47,000	66,000	0,39	KRT47XLL	44	NTN			
	47,000	66,000	0,39	KRU47LL	44	NTN			
	47,000	66,000	0,77	KRU47XLL	44	NTN			
	47,000	66,000	0,39	KRV47LL	44	NTN			
	47,000	66,000	1,17	KRVT47	44	NTN			
	47,000	66,000	1,17	KRVT47LL	44	NTN			
	47,000	66,000	1,17	KRVT47XLL	44	NTN			
	47,000	66,000	1,17	KRVU47LL	44	NTN			
	47,000	66,000	1,17	KRVU47XLL	44	NTN			
	47,000	66,000	1,14	NUKRT47	51	NTN			
	47,000	66,000	0,76	NUKRT47X	51	NTN			
	47,000	66,000	0,38	NUKRU47	51	NTN			
	47,000	66,000	0,38	NUKRU47X	51	NTN			
	52,000	25,000	0,95	NUTR304	52	NTN			
	52,000	25,000	0,95	NUTR304X	52	NTN			
	52,000	46,000	0,50	ARN2052	54	NTN			
	52,000	66,000	1,38	KR52	44	NTN			
	52,000	66,000	1,38	KR52LL	44	NTN			
	52,000	66,000	1,38	KR52X	44	NTN			
	52,000	66,000	1,38	KR52XLL	44	NTN			
	52,000	66,000	1,38	KRT52LL	44	NTN			
	52,000	66,000	1,38	KRT52XLL	44	NTN			
	52,000	66,000	0,92	KRU52	44	NTN			
	52,000	66,000	1,38	KRU52LL	44	NTN			
	52,000	66,000	1,38	KRU52XLL	44	NTN			
	52,000	66,000	1,40	KRV52XLL	44	NTN			
	52,000	66,000	1,40	KRVT52LL	44	NTN			
	52,000	66,000	0,93	KRVT52XLL	44	NTN			
	52,000	66,000	0,54	KRVU52	44	NTN			
	52,000	66,000	0,54	KRVU52XLL	44	NTN			
	52,000	66,000	0,45	NUKR52	51	NTN			
	52,000	66,000	1,35	NUKR52X	51	NTN			
	52,000	66,000	1,35	NUKRT52	51	NTN			
	52,000	66,000	1,35	NUKRT52X	51	NTN			
	52,000	66,000	0,45	NUKRU52X	51	NTN			
	72,000	80,000	1,00	KRVU72XLL	44	NTN			
72,000	165,000	0,50	ARX20X72X165	59	NTN				
20,500	27,500	11,800	0,04	PK20.5X27.5X11.8	40	NTN			
	35,000	1,500	0,02	XS20.5X35X1.5	58	NTN			
21,000	25,000	12,800	0,02	KMJ21X25X12.8	40	NTN			
	25,000	16,800	0,04	K21X25X17	40	NTN			
	27,000	19,800	0,06	PK21X27X19.8	40	NTN			
	28,000	10,000	0,04	HKS21X28X10	47	NTN			
	29,000	16,000	0,08	NK21/16R	41	NTN			
	29,000	20,000	0,03	HMK2120	47	NTN			
	29,000	20,000	0,01	NK21/20R	41	NTN			
	33,000	2,200	0,02	AS21X33X2.2	58	NTN			
	35,000	2,750	0,04	GS81104	58	NTN			
	40,000	3,200	0,02	XS21X40X3.2	58	NTN			

								Brands	
d	D	B	Kg	Reference					
21,300	29,500	17,300	0,02	KMJ21.3X29.5X17.3	40	NTN			
21,500	40,000	58,000	0,73	NUKR40X	51	NTN			
21,670	29,670	15,800	0,05	PK21.6X29.6X15.8	40	NTN			
22,000	25,000	16,000	0,03	1R22X25X16	55	NTN			
	26,000	9,600	0,02	K22X26X9.6	40	NTN			
	26,000	9,800	0,01	K22X26X10	40	NTN			
	26,000	10,000	0,04	1R22X26X10	55	NTN			
	26,000	10,600	0,01	K22X26X10.6	40	NTN			
	26,000	10,800	0,01	K22X26X11	40	NTN			
	26,000	12,800	0,03	K22X26X13	40	NTN			
	26,000	12,800	0,01	KV22X26X13	40	NTN			
	26,000	14,300	0,01	K22X26X14.3	40	NTN			
	26,000	16,000	0,05	1R22X26X16	55	NTN			
	26,000	16,800	0,01	K22X26X17	40	NTN			
	26,000	17,000	0,02	1R22X26X17	55	NTN			
	26,000	20,000	0,07	1R22X26X20	55	NTN			
	26,000	20,500	0,07	1R22X26X20.5	55	NTN			
	26,000	22,800	0,05	GK22X26X22.8	40	NTN			
	26,000	22,800	0,04	KJ22X26X22.8	40	NTN			
	26,000	25,000	0,06	1R22X26X25	55	NTN			
	26,000	33,800	0,06	KV22X26X33.8ZV	40	NTN			
	27,000	19,800	0,06	K22X27X20	40	NTN			
	27,000	21,300	0,04	KV22X27X21.3	40	NTN			
	27,000	28,300	0,08	K22X27X28.3	40	NTN			
	28,000	12,000	0,02	BK2212	48	NTN			
	28,000	12,000	0,03	HK2212	47	NTN			
	28,000	13,800	0,01	PK22X28X13.8	40	NTN			
	28,000	15,800	0,05	PK22X28X15.8	40	NTN			
	28,000	16,000	0,06	HK2216	47	NTN			
	28,000	16,000	0,06	HK2216D	47	NTN			
	28,000	16,000	0,06	HK2216LL	47	NTN			
	28,000	16,800	0,04	K22X28X17	40	NTN			
	28,000	16,800	0,06	KJ22X28X17	40	NTN			
	28,000	16,800	0,06	PK22X28X16.8	40	NTN			
	28,000	17,000	0,10	1R22X28X17	55	NTN			
	28,000	18,000	0,02	HK2218L	47	NTN			
	28,000	19,500	0,07	KV22X28X19.5	40	NTN			
	28,000	20,000	0,07	1R22X28X20	55	NTN			
	28,000	20,000	0,09	BK2220	48	NTN			
	28,000	20,000	0,08	HK2220	47	NTN			
	28,000	20,000	0,08	HK2220D	47	NTN			
	28,000	20,000	0,07	HK2220LL	47	NTN			
	28,000	20,500	0,11	1R22X28X20.5	55	NTN			
28,000	22,800	0,08	K22X28X22.8	40	NTN				
28,000	23,000	0,08	1R22X28X23	55	NTN				
28,000	29,900	0,04	KBK22X28X29.9	40	NTN				
28,000	30,000	0,16	1R22X28X30	55	NTN				
29,000	10,000	0,03	HMK2210	47	NTN				
29,000	13,800	0,01	H22X29X13.8	40	NTN				
29,000	15,800	0,07	K22X29X16	40	NTN				
29,000	15,800	0,02	PK22X29X15.8	40	NTN				
29,000	17,800	0,07	PK22X29X17.8	40	NTN				
29,000	18,000	0,05	HMK2218L	47	NTN				
29,000	20,000	0,09	HMK2220	47	NTN				
29,000	21,000	0,03	HMK2221LL	47	NTN				
29,000	25,000	0,04	HMK2225	47	NTN				
29,000	26,000	0,07	HMK2226LL	47	NTN				
29,000	30,000	0,13	HMK2230	47	NTN				
29,000	38,000	0,23	1R22X29X38	55	NTN				

								Brands	
d	D	B	Kg	Reference					
22,000	30,000	11,800	0,04	K22X30X11.8	40	NTN			
	30,000	13,000	0,03	RNA0-22X30X13	41	NTN			
	30,000	13,000	0,08	RNA4903LL	41	NTN			
	30,000	14,700	0,02	PK22X30X14.7	40	NTN			
	30,000	14,800	0,08	K22X30X15	40	NTN			
	30,000	16,000	0,08	NK22/16R	41	NTN			
	30,000	16,800	0,09	K22X30X16.8	40	NTN			
	30,000	16,800	0,05	PK22X30X16.8	40	NTN			
	30,000	17,300	0,07	KMJ22X30X17.3	40	NTN			
	30,000	17,800	0,08	PK22X30X17.8	40	NTN			
	30,000	18,000	0,09	RNA5903	41	NTN			
	30,000	19,800	0,10	K22X30X19.8	40	NTN			
	30,000	20,000	0,11	NK22/20R	41	NTN			
	30,000	23,000	0,12	RNA6903R	41	NTN			
	30,000	23,800	0,10	KMJ22X30X23.8	40	NTN			
	30,000	26,000	0,05	RNA0-22X30X26ZW	41	NTN			
	31,000	16,800	0,62	PK22X31X16.8	40	NTN			
	31,000	24,800	0,04	PK22X31X24.8	40	NTN			
	32,000	13,400	0,09	K22X32X13.4	40	NTN			
	32,000	17,000	0,11	1R22X32X17	55	NTN			
	32,000	25,000	0,16	K22X32X25	40	NTN			
	32,000	44,800	0,28	K22X32X44.8	40	NTN			
	34,000	16,000	0,10	NK26/16R+1R22X26X16	42	NTN			
	34,000	20,000	0,13	NK26/20R+1R22X26X20	42	NTN			
	35,000	16,000	0,06	RNA0-22X35X16	41	NTN			
	35,000	20,000	0,07	NKS22	41	NTN			
	35,000	32,000	0,26	RNA0-22X35X32ZW	41	NTN			
	36,800	3,000	0,02	XS22X36.8X3	58	NTN			
	37,000	2,000	0,02	AKJ22X37X2	57	NTN			
	38,000	1,000	0,01	AS22X38X1	58	NTN			
	39,000	6,000	0,06	ARXJ22X39X6	59	NTN			
	39,000	17,000	0,24	NA49/22R	42	NTN			
	39,000	23,000	0,27	NA59/22	42	NTN			
	39,000	23,000	0,24	NK1A59/22A	53	NTN			
	39,000	30,000	0,45	NA69/22R	42	NTN			
	40,000	15,800	0,29	RNA2203LL	41	NTN			
	40,000	15,800	0,29	RNA2203XLL	41	NTN			
	40,000	16,000	0,29	RNAB203	43-A	NTN			
	40,000	16,000	0,10	RNAB203X	43-A	NTN			
	40,000	58,000	0,50	KRV40X	44	NTN			
40,000	58,000	0,87	KRVT40LL	44	NTN				
40,000	58,000	0,59	KRVT40XLL	44	NTN				
48,000	16,000	0,28	ARX22X48X16	59	NTN				
50,400	17,000	0,26	HK22X50.4X17	47	NTN				
62,000	3,000	0,17	XS23X62X3	58	NTN				
22,100	40,000	4,200	0,01	ARXJ22.1X40X4.2	59	NTN			
22,150	30,000	17,500	0,08	1R22.1X30X17.5	55	NTN			
22,200	27,200	23,600	0,06	KJ22.2X27.2X23.6	40	NTN			
	28,500	31,700	0,11	PK22.2X28.5X31.7	40	NTN			
	42,300	3,800	0,05	ARXJ22.2X42.3X3.8	59	NTN			
22,218	36,000	17,000	0,18	NK22.2X36X17	41	NTN			
22,225	28,575	25,650	0,05	M1-141816	55	NTN			
	28,575	32,000	0,06	M1-141820	55	NTN			
	34,925	19,050	0,18	MR142212	41	NTN			
	34,925	25,400	0,08	MR142216	41	NTN			
	50,800	84,100	1,30	CRV32XLL	44	NTN			

								Brands	
d	D	B	Kg	Reference					
22,300	26,300	19,800	0,03	K22.3X26.3X19.8	40	NTN			
23,000	27,000	12,800	0,03	KMJ23X27X12.8	40	NTN			
	28,000	24,800	0,06	KJ23X28X24.8	40	NTN			
	29,000	17,800	0,06	KMJ23X29X17.8	40	NTN			
	37,000	24,700	0,03	KJ32X37X24.7	40	NTN			
	42,000	2,800	0,04	ARXJ23X42X2.8	59	NTN			
23,100	28,100	13,900	0,04	PK23.1X28.1X13.9	40	NTN			
23,390	29,745	9,000	0,04	HKS23.3X29.7X9	47	NTN			
23,800	44,700	11,000	0,20	ARX23.8X44.7X11	59	NTN			
24,000	28,000	9,800	0,02	K24X28X10	40	NTN			
	28,000	12,800	0,03	K24X28X13	40	NTN			
	30,000	13,800	0,05	PK24X30X13.8	40	NTN			
	30,000	16,800	0,07	K24X30X17	40	NTN			
	30,000	24,100	0,08	KMJ24X30X24.1	40	NTN			
	30,000	30,800	0,08	K24X30X31ZW	40	NTN			
	31,000	16,800	0,02	PK24X31X16.8	40	NTN			
	31,000	20,000	0,06	HMK2420	47	NTN			
	31,000	20,000	0,09	HMK2420C	47	NTN			
	31,000	23,000	0,07	HMK2423L	47	NTN			
	32,000	16,000	0,09	NK24/16R	41	NTN			
	32,000	19,800	0,10	PK24X32X19.8	40	NTN			
	32,000	20,000	0,04	NK24/20R	41	NTN			
	36,000	2,000	0,01	AKJ24X36X2	57	NTN			
	37,000	20,000	0,14	NKS24R	41	NTN			
	50,000	19,000	0,51	NK30.5X50X17+1R22X43X19	42	NTN			
	62,000	80,000	2,37	KR62	44	NTN			
	62,000	80,000	2,37	KR62LL	44	NTN			
	62,000	80,000	1,58	KR62X	44	NTN			
	62,000	80,000	2,37	KR62XLL	44	NTN			
	62,000	80,000	0,79	KRT62LL	44	NTN			
	62,000	80,000	0,79	KRT62XLL	44	NTN			
	62,000	80,000	1,58	KRU62LL	44	NTN			
	62,000	80,000	0,79	KRU62XLL	44	NTN			
	62,000	80,000	2,40	KRV62LL	44	NTN			
	62,000	80,000	2,40	KRV62XLL	44	NTN			
	62,000	80,000	0,89	NUKRT62	51	NTN			
	72,000	80,000	3,12	KR72	44	NTN			
	72,000	80,000	2,08	KR72X	44	NTN			
	72,000	80,000	1,04	KR72XLL	44	NTN			
	72,000	80,000	1,04	KRT72LL	44	NTN			
	72,000	80,000	1,04	KRT72XLL	44	NTN			
72,000	80,000	3,15	KRV72XLL	44	NTN				
72,000	80,000	1,05	KRV72LL	44	NTN				
72,000	80,000	1,05	KRV72XLL	44	NTN				
72,000	80,000	3,03	NUKR72X	51	NTN				
72,000	80,000	2,02	NUKRT72	51	NTN				
72,000	80,000	1,01	NUKRU72X	51	NTN				
29,000	9,800	0,03	K25X29X10	40	NTN				
29,000	12,800	0,03	K25X29X13	40	NTN				
29,000	16,800	0,05	K25X29X17	40	NTN				
29,000	19,800	0,03	K25X29X19.8	40	NTN				
29,000	20,000	0,08	1R25X29X20	55	NTN				
29,000	24,500	0,03	1R25X29X24.5	55	NTN				
29,000	28,000	0,11	1R25X29X28	55	NTN				
29,000	30,000	0,12	1R25X29X30	55	NTN				
30,000	12,500	0,06	1R25X30X12.5	55	NTN				
30,000	12,800	0,05	K25X30X13	40	NTN				



								Brands	
d	D	B	Kg	Reference					
25,000	30,000	13,000	0,02	1R25X30X13	55	NTN			
	30,000	16,000	0,08	1R25X30X16	55	NTN			
	30,000	16,500	0,05	1R25X30X16.5	55	NTN			
	30,000	16,800	0,05	K25X30X17	40	NTN			
	30,000	17,000	0,08	1R25X30X17	55	NTN			
	30,000	18,000	0,09	1R25X30X18	55	NTN			
	30,000	18,800	0,04	K25X30X18.8	40	NTN			
	30,000	18,800	0,05	KJ25X30X18.8	40	NTN			
	30,000	19,800	0,03	GK25X30X20S	40	NTN			
	30,000	19,800	0,02	K25X30X19.8	40	NTN			
	30,000	19,800	0,07	K25X30X20	40	NTN			
	30,000	19,800	0,02	KJ25X30X20	40	NTN			
	30,000	20,000	0,10	1R25X30X20	55	NTN			
	30,000	20,500	0,10	1R25X30X20.5	55	NTN			
	30,000	21,800	0,01	GK25X30X21.8	40	NTN			
	30,000	21,800	0,02	K25X30X21.8	40	NTN			
	30,000	21,800	0,06	KMJ25X30X21.8	40	NTN			
	30,000	22,800	0,05	K25X30X22.8	40	NTN			
	30,000	23,000	0,11	1R25X30X23	55	NTN			
	30,000	23,800	0,05	K25X30X23.8	40	NTN			
	30,000	23,800	0,07	KJ25X30X23.8	40	NTN			
	30,000	25,000	0,41	1R25X30X25	55	NTN			
	30,000	25,000	0,07	KJ25X30X25	40	NTN			
	30,000	25,800	0,09	K25X30X26ZW	40	NTN			
	30,000	26,000	0,09	1R25X30X26	55	NTN			
	30,000	26,000	0,04	GK25X30X25.8	40	NTN			
	30,000	26,500	0,13	1R25X30X26.5	55	NTN			
	30,000	30,000	0,15	1R25X30X30	55	NTN			
	30,000	31,000	0,05	1R25X30X31	55	NTN			
	30,000	32,000	0,16	1R25X30X32	55	NTN			
	30,000	38,500	0,13	1R25X30X38.5	55	NTN			
	30,000	38,800	0,11	K25X30X39ZW	40	NTN			
	30,000	80,000	0,27	1R25X30X80	55	NTN			
	30,000	85,000	0,29	1R25X30X85	55	NTN			
	31,000	12,800	0,05	K25X31X13	40	NTN			
	31,000	13,000	0,05	K25X31X12.6	40	NTN			
	31,000	13,500	0,06	K25X31X13.5	40	NTN			
	31,000	13,800	0,06	K25X31X14	40	NTN			
	31,000	16,800	0,07	K25X31X17	40	NTN			
	31,000	16,800	0,04	PK25X31X16.8	40	NTN			
	31,000	18,300	0,04	KMJ25X31X18.3	40	NTN			
	31,000	20,800	0,08	K25X31X21	40	NTN			
	31,000	21,800	0,08	GK25X31X21.8	40	NTN			
	31,000	23,900	0,09	K25X31X23.9	40	NTN			
	31,000	24,420	0,10	K25X31X24.4	40	NTN			
	31,000	25,800	0,02	GK25X31X25.8	40	NTN			
	32,000	12,000	0,04	HK2512	47	NTN			
	32,000	14,000	0,06	HKS25X32X14	47	NTN			
	32,000	15,000	0,10	1R25X32X15	55	NTN			
	32,000	15,800	0,01	H25X32X15.80	40	NTN			
	32,000	15,800	0,03	H25X32X15.85	40	NTN			
	32,000	15,800	0,08	K25X32X16	40	NTN			
	32,000	15,800	0,05	PK25X32X15.8	40	NTN			
	32,000	16,000	0,03	BK2516	48	NTN			
	32,000	16,000	0,03	HK2516	47	NTN			
32,000	16,000	0,03	HK2516D	47	NTN				
32,000	16,000	0,05	HK2516LL	47	NTN				
32,000	16,000	0,05	HK2516LLD	47	NTN				
32,000	18,000	0,03	HK2518L	47	NTN				
32,000	18,000	0,06	HK2518LD	47	NTN				
32,000	20,000	0,12	BK2520	48	NTN				
32,000	20,000	0,04	HK2520	47	NTN				

								Brands	
d	D	B	Kg	Reference					
25,000	32,000	20,000	0,10	HK2520D	47	NTN			
	32,000	20,000	0,06	HK2520LL	47	NTN			
	32,000	22,000	0,16	1R25X32X22	55	NTN			
	32,000	22,000	0,04	BKS25X32X22	48	NTN			
	32,000	26,000	0,04	HK2526	47	NTN			
	32,000	26,000	0,13	HK2526D	47	NTN			
	32,000	26,500	0,18	1R25X32X26.5	55	NTN			
	32,000	30,500	0,22	1R25X32X30.5	55	NTN			
	32,000	31,300	0,12	KJ25X32X31.3	40	NTN			
	32,000	31,300	0,92	KV25X32X31.3	40	NTN			
	32,000	34,000	0,11	HKS25X32X34ZW	47	NTN			
	32,000	36,000	0,18	1R25X32X36	55	NTN			
	32,000	38,000	0,19	HK2538ZWD	47	NTN			
	33,000	10,000	0,04	HMK2510	47	NTN			
	33,000	13,800	0,07	PK25X33X13.8	40	NTN			
	33,000	15,000	0,03	HMK2515	47	NTN			
	33,000	15,000	0,09	HMK2515C	47	NTN			
	33,000	16,000	0,09	NK25/16R	41	NTN			
	33,000	18,000	0,10	HKS25X33X18	47	NTN			
	33,000	18,000	0,03	HMK2518L	47	NTN			
	33,000	20,000	0,11	HMK2520	47	NTN			
	33,000	20,000	0,08	NK25/20R	41	NTN			
	33,000	21,000	0,07	HMK2521LL	47	NTN			
	33,000	23,000	0,13	HMK2523L	47	NTN			
	33,000	23,800	0,12	KMJ25X33X24	40	NTN			
	33,000	23,800	0,13	PK25X33X23.8	40	NTN			
	33,000	25,000	0,14	HMK2525	47	NTN			
	33,000	25,000	0,06	NK25X33X25	41	NTN			
	33,000	26,000	0,09	HMK2526LL	47	NTN			
	33,000	30,000	0,17	HMK2530	47	NTN			
	33,000	30,000	0,18	NK25X33X30	41	NTN			
	35,000	13,800	0,07	PK25X35X13.8	40	NTN			
	35,000	15,900	0,08	PK25X35X15.9	40	NTN			
	35,000	17,000	0,05	RNA0-25X35X17	41	NTN			
	35,000	17,400	0,04	PK25X35X17.4	40	NTN			
	35,000	19,800	0,08	K25X35X19.8	40	NTN			
	35,000	24,800	0,16	PK25X35X24.8	40	NTN			
	35,000	26,000	0,08	RNA0-25X35X26ZW	41	NTN			
	35,000	29,800	0,22	K25X35X29.8	40	NTN			
	35,000	40,000	0,19	KH2540	60	NTN			
	35,000	40,000	0,20	KH2540LL	60	NTN			
	36,000	16,800	0,09	PK25X36X16.8	40	NTN			
	37,000	17,000	0,21	RNA4904L	41	NTN			
	37,000	17,000	0,19	RNA4904LL	41	NTN			
	37,000	17,000	0,05	RNA4904R	41	NTN			
	37,000	17,000	0,16	RNA4904RLL	41	NTN			
	37,000	23,000	0,08	RNA5904	41	NTN			
	37,000	30,000	0,26	NKXR25	50	NTN			
	37,000	30,000	0,40	NKXR25Z	50	NTN			
	37,000	32,000	0,11	RNA0-25X37X32ZW	41	NTN			
	37,000	45,000	0,02	KD253745	61	NTN			
	37,000	45,000	0,36	KD253745LL	61	NTN			
	38,000	2,000	0,01	AKJ25X38X2	57	NTN			
	38,000	20,000	0,23	NK29/20R+1R25X29X20	42	NTN			
	38,000	20,000	0,21	NKS25R	41	NTN			
38,000	30,000	0,24	NK29/30R+1R25X29X30	42	NTN				
38,000	40,000	0,47	NK29/20RD2+1R25X29X20D2	42	NTN				
40,000	17,000	0,09	NA0-25X40X17	42	NTN				
42,000	1,000	0,02	AS1105	58	NTN				
42,000	2,000	0,02	AXK1105	57	NTN				
42,000	3,000	0,06	WS81105	58	NTN				
42,000	4,800	0,02	ARXJ25X42X4.8	59	NTN				

								Brands		
d	D	B	Kg	Reference						
25,000	42,000	5,000	0,04	K81105	57	NTN				
	42,000	11,000	0,10	81105	56	NTN				
	42,000	17,000	0,27	NA4905R	42	NTN				
	42,000	18,000	0,30	NA4905LL	42	NTN				
	42,000	23,000	0,36	NA5905	42	NTN				
	42,000	23,000	0,25	NK1A5905A	53	NTN				
	42,000	30,000	0,48	NA6905R	42	NTN				
	42,000	30,000	0,13	NKX25	49	NTN				
	42,000	30,000	0,39	NKX25Z	49	NTN				
	42,000	40,000	0,39	AXN2052	57	NTN				
	44,450	71,400	0,38	CR28	44	NTN				
	44,450	71,400	0,38	CR28X	44	NTN				
	45,000	12,000	0,16	ARX25X45X12	59	NTN				
	45,000	17,500	0,39	NK25X45X17.5NR	41	NTN				
	45,000	18,500	0,39	NK25X45X18.5NR	41	NTN				
	47,000	16,000	0,40	RNAB204X	43-A	NTN				
	47,000	17,000	0,13	RNA4906R+1R25X35X17	41	NTN				
	47,000	17,800	0,47	RNA2204LL	41	NTN				
	47,000	17,800	0,47	RNA2204XLL	41	NTN				
	47,000	66,000	1,17	KRV47	44	NTN				
	47,000	66,000	0,78	KRV47X	44	NTN				
	47,000	66,000	1,17	KRV47XLL	44	NTN				
	52,000	18,000	0,62	NA2205LL	43	NTN				
	52,000	18,000	0,21	NA2205XLL	43	NTN				
	52,000	25,000	0,86	NATR25	45	NTN				
	52,000	25,000	0,28	NATR25LL	45-A	NTN				
	52,000	25,000	0,57	NATR25X	45	NTN				
	52,000	25,000	0,83	NATR25XLL	45-A	NTN				
	52,000	25,000	0,84	NUTR205	52	NTN				
	52,000	25,000	0,84	NUTR205X	52	NTN				
	52,000	66,000	0,05	KRV52	44	NTN				
	52,000	66,000	1,40	KRV52LL	44	NTN				
	52,000	66,000	1,40	KRV52X	44	NTN				
	52,200	15,000	0,15	NK15X52.2X15	41	NTN				
	57,000	50,000	1,59	ARN2557	54	NTN				
	58,000	20,000	0,87	NK15X58X20NR	41	NTN				
	62,000	25,000	1,34	NUTR305	52	NTN				
	62,000	25,000	1,34	NUTR305X	52	NTN				
	70,000	153,000	3,94	ARX25X70X153	59	NTN				
	25,100	30,100	13,800	0,04	KMJ25.1X30.1X13.8	40	NTN			
		30,100	13,800	0,01	PK25.1X30.1X13.8	40	NTN			
	25,200	31,120	11,500	0,05	HKS25.2X31.1X11.5	47	NTN			
	25,400	31,700	21,000	0,07	HKS25.4X31.7X21	47	NTN			
31,750		19,300	0,08	M1-162012	55	NTN				
31,750		23,050	0,07	HKS25.4X31.7X23	47	NTN				
31,750		25,650	0,11	M1-162016	55	NTN				
31,750		32,000	0,14	M1-162020	55	NTN				
33,300		15,700	0,08	PK25.4X33.3X15.7	40	NTN				
33,338		19,050	0,10	PCJ162112	40	NTN				
33,338		25,400	0,13	PCJ162116	40	NTN				
38,100		19,050	0,20	MR162412	41	NTN				
38,100		25,400	0,18	MR162416	41	NTN				
40,300		2,800	0,02	ARXJ25.4X40.3X2.8	59	NTN				
63,500		96,800	1,15	CRV40XLL	44	NTN				
76,200		46,038	2,90	NACV48XLL	46	NTN				
25,500		40,000	1,800	0,03	AS25.5X40X1.8	58	NTN			
		40,000	2,200	0,04	AS25.5X40X2.2	58	NTN			
	47,000	22,000	0,18	NK25.5X47X22	41	NTN				

								Brands	
d	D	B	Kg	Reference					
25,500	47,000	66,000	1,14	NUKR47	51	NTN			
	47,000	66,000	1,14	NUKR47X	51	NTN			
26,000	30,000	12,800	0,04	K26X30X13	40	NTN			
	30,000	16,800	0,05	K26X30X17	40	NTN			
	30,000	17,000	0,04	GK26X30X17S	40	NTN			
	31,000	9,800	0,03	PK26X31X9.8	40	NTN			
	31,000	13,800	0,03	PK26X31X13.8	40	NTN			
	31,000	19,100	0,04	K26X31X19.1	40	NTN			
	31,000	21,800	0,06	KJ26X31X21.8	40	NTN			
	31,000	25,800	0,07	KJ26X31X25.8	40	NTN			
	31,000	27,800	0,08	KJ26X31X27.8	40	NTN			
	32,000	16,800	0,01	H26X32X16.8	40	NTN			
	33,000	13,800	0,06	KM.J26X33X13.8	40	NTN			
	33,000	15,800	0,03	H26X33X15.8	40	NTN			
	34,000	16,000	0,10	NK26/16R	41	NTN			
	34,000	19,800	0,04	PK26X34X19.8	40	NTN			
	34,000	20,000	0,11	HMK2620	47	NTN			
	34,000	20,000	0,12	NK26/20R	41	NTN			
	35,000	24,800	0,17	PK26X35X24.8	40	NTN			
	35,000	25,000	0,19	NK26X35X25	41	NTN			
	35,000	25,500	0,19	NK26X35X25.5	41	NTN			
	35,000	35,000	0,24	1R26X35X35X	55	NTN			
	36,000	13,800	0,05	PK26X32X13.8	40	NTN			
	39,000	13,000	0,06	RNA0-26X39X13	41	NTN			
	42,000	1,000	0,01	AS26X42X1	58	NTN			
	42,000	3,000	0,06	GS81105	58	NTN			
	42,000	4,000	0,08	XS26X42X4	58	NTN			
	42,600	2,800	0,04	ARXJ26X42.6X2.8	59	NTN			
26,200	53,000	56,800	1,97	NK26.2X53X56.8	41	NTN			
26,500	42,000	2,000	0,03	XS26.5X42X2	58	NTN			
26,700	40,960	2,800	0,02	ARXJ26.7X40.9X2.8	59	NTN			
27,000	31,000	16,800	0,04	KJ27X31X16.8	40	NTN			
	32,000	21,800	0,07	PK27X32X21.8	40	NTN			
	32,000	23,800	0,07	KJ27X32X23.8	40	NTN			
	32,000	34,000	0,06	1R27X32X34	55	NTN			
	32,000	38,000	0,20	1R27X32X38	55	NTN			
	32,000	39,300	0,14	1R27X32X39.3	55	NTN			
	32,000	39,500	0,07	1R27X32X39.5	55	NTN			
	35,000	10,000	0,03	NK27X35X10NR	41	NTN			
	35,000	15,800	0,06	PK27X35X15.8	40	NTN			
	36,000	20,800	0,14	PK27X36X20.8	40	NTN			
38,000	17,300	0,09	K27X38X17.3	40	NTN				
46,000	21,000	0,40	NK27X46X21	41	NTN				
27,400	32,000	25,800	0,04	1R27.4X32X25.8	55	NTN			
27,500	33,500	21,800	0,05	GK27.5X33.5X21.8	40	NTN			
	56,000	3,000	0,09	XS27.5X56X3	58	NTN			
	72,000	3,000	0,09	XS27.5X72X3	58	NTN			
28,000	31,000	10,000	0,02	1R28X31X10	55	NTN			
	32,000	16,800	0,05	K28X32X17	40	NTN			
	32,000	17,000	0,05	1R28X32X17	55	NTN			
	32,000	20,000	0,09	1R28X32X20	55	NTN			
	32,000	20,800	0,02	K28X32X21	40	NTN			
	32,000	23,000	0,07	1R28X32X23	55	NTN			
	32,000	26,800	0,07	K28X32X26.8	40	NTN			



								Brands		
d	D	B	Kg	Reference						
28,000	32,000	27,000	0,12	1R28X32X27	55	NTN				
	32,000	30,000	0,09	1R28X32X30	55	NTN				
	33,000	12,800	0,05	K28X33X13	40	NTN				
	33,000	13,800	0,02	PK28X33X13.8	40	NTN				
	33,000	16,800	0,02	K28X33X16.8	40	NTN				
	33,000	16,800	0,07	K28X33X17	40	NTN				
	33,000	16,800	0,05	KJ28X33X17	40	NTN				
	33,000	19,800	0,06	KJ28X33X19.8	40	NTN				
	33,000	21,800	0,08	K28X33X21.8	40	NTN				
	33,000	25,800	0,09	K28X33X26ZW	40	NTN				
	33,000	26,800	0,10	K28X33X27	40	NTN				
	33,000	26,800	0,08	KJ28X33X26.8	40	NTN				
	33,000	29,800	0,03	KJ28X33X29.8	40	NTN				
	34,000	13,800	0,04	K28X34X14	40	NTN				
	34,000	14,000	0,07	GK28X34X14	40	NTN				
	34,000	16,800	0,03	K28X34X17	40	NTN				
	34,000	16,800	0,07	KMJ28X34X16.8	40	NTN				
	34,000	16,800	0,07	PK28X34X16.8	40	NTN				
	34,000	19,800	0,05	GK28X34X19.8	40	NTN				
	35,000	13,800	0,07	KMJ28X35X13.8	40	NTN				
	35,000	13,800	0,07	PK28X35X13.8	40	NTN				
	35,000	15,600	0,03	PK28X35X15.6	40	NTN				
	35,000	15,800	0,06	K28X35X16	40	NTN				
	35,000	16,000	0,06	HK2816	47	NTN				
	35,000	17,800	0,10	K28X35X18	40	NTN				
	35,000	18,000	0,04	GK28X35X18	40	NTN				
	35,000	19,800	0,15	PK28X38X19.8	40	NTN				
	35,000	20,000	0,04	BK2820D	48	NTN				
	35,000	20,000	0,04	HK2820	47	NTN				
	35,000	20,000	0,04	HK2820D	47	NTN				
	35,000	20,000	0,10	HK2820LL	47	NTN				
	35,000	32,000	0,26	1R28X35X32	55	NTN				
	36,000	13,800	0,08	PK28X36X13.8	40	NTN				
	36,000	15,800	0,09	PK28X36X15.8	40	NTN				
	37,000	20,000	0,13	HMK2820	47	NTN				
	37,000	20,000	0,15	NK28/20R	41	NTN				
	37,000	20,800	0,09	PK28X37X20.8	40	NTN				
	37,000	30,000	0,20	HMK2830	47	NTN				
	37,000	30,000	0,23	NK28/30R	41	NTN				
	38,000	15,800	0,04	PK28X38X15.8	40	NTN				
	38,000	16,800	0,08	PK28X38X16.8	40	NTN				
	39,000	17,000	0,10	RNA49/22R	41	NTN				
	39,000	23,000	0,02	RNA59/22	41	NTN				
	39,000	30,000	0,18	RNA69/22R	41	NTN				
	41,000	25,000	0,20	K28X41X25	40	NTN				
	41,000	34,500	0,12	PK28X41X34.5	40	NTN				
	42,000	20,000	0,28	NK32/20R+1R28X32X20	42	NTN				
	42,000	20,000	0,25	NKS28R	41	NTN				
	42,000	23,000	0,33	NK28X42X23	41	NTN				
	42,000	30,000	0,42	NK32/30R+1R28X32X30	42	NTN				
	42,700	3,000	0,03	ARXJ28X42.7X3	59	NTN				
	43,000	2,000	0,02	AKJ28X43X2	57	NTN				
	45,000	17,000	0,20	NA49/28R	42	NTN				
	45,000	25,000	0,44	NK28X45X25	41	NTN				
	45,000	30,000	0,53	NA69/28R	42	NTN				
	46,000	4,300	0,02	ARXJ28X46X4.3	59	NTN				
	51,600	6,000	0,04	ARXJ28X51.6X6	59	NTN				
	74,000	17,000	0,32	HKZ28X74X17	47	NTN				
	28,100	32,100	23,800	0,06	KJ28.1X32.1X23.8	40	NTN			
28,120	40,000	17,500	0,08	1R28.1X40X17.5	55	NTN				

								Brands	
d	D	B	Kg	Reference					
28,190	42,164	10,185	0,06	XS28.1X42.1X10.1	58	NTN			
28,200	45,100	8,600	0,08	ARXJ28.2X45.1X8.6	59	NTN			
28,500	38,100	25,400	0,18	PK28.5X38.1X25.4	40	NTN			
	38,100	27,500	0,06	PK28.5X38.1X27.5	40	NTN			
	38,500	21,800	0,06	PK28.5X38.5X21.8	40	NTN			
28,575	34,925	25,650	0,06	M1-182216	55	NTN			
	34,925	32,000	0,16	M1-182220	55	NTN			
	38,100	1,500	0,01	AKJ28.5X38.1X1.5	57	NTN			
	38,100	31,750	0,12	PCJ182420	40	NTN			
	38,100	31,800	0,23	PK28.5X38.1X31.8	40	NTN			
	41,275	25,400	0,02	MR182616	41	NTN			
	41,275	31,750	0,36	MR182620	41	NTN			
28,780	37,850	2,200	0,03	AS28.7X37.8X2.2	58	NTN			
	37,850	2,200	0,02	XS28.7X37.8X2.2	58	NTN			
29,000	32,000	13,000	0,02	1R29X32X13	55	NTN			
	33,000	25,800	0,04	1R29X33X25.8	55	NTN			
	34,000	16,800	0,05	K29X34X17	40	NTN			
	34,000	23,800	0,05	KJ29X34X23.8	40	NTN			
	34,000	26,800	0,07	K29X34X27	40	NTN			
	34,000	27,800	0,11	K29X34X27.8	40	NTN			
	34,000	27,800	0,03	KJ29X34X27.8	40	NTN			
	35,000	20,300	0,05	K29X35X20.3	40	NTN			
	36,000	18,000	0,10	HKS29X36X18	47	NTN			
	38,000	20,000	0,14	HMK2920	47	NTN			
	38,000	20,000	0,11	NK29/20R	41	NTN			
	38,000	30,000	0,16	NK29/30R	41	NTN			
	43,000	1,000	0,02	AS29X43X1	58	NTN			
	43,000	42,800	0,57	PK29X43X42.8	40	NTN			
	29,300	49,000	8,800	0,10	ARXJ29.3X49X8.8	59	NTN		
29,800	35,000	19,000	0,08	1R29.8X35X19	55	NTN			
	47,000	3,800	0,04	ARXJ29.8X47X3.8	59	NTN			
30,000	34,000	13,800	0,04	KV30X34X13.8	40	NTN			
	34,000	22,800	0,04	K30X34X22.8	40	NTN			
	34,000	29,800	0,03	K30X34X29.8ZW	40	NTN			
	34,000	33,800	0,05	GK30X34X33.8XZW	40	NTN			
	35,000	10,800	0,05	K30X35X11	40	NTN			
	35,000	12,500	0,05	1R30X35X12.5	55	NTN			
	35,000	12,800	0,05	K30X35X13	40	NTN			
	35,000	12,800	0,05	KV30X35X13	40	NTN			
	35,000	13,000	0,05	1R30X35X13	55	NTN			
	35,000	16,000	0,06	1R30X35X16	55	NTN			
	35,000	16,500	0,07	1R30X35X16.5	55	NTN			
	35,000	16,500	0,06	KJ30X35X16.5	40	NTN			
	35,000	16,800	0,07	K30X35X17	40	NTN			
	35,000	16,800	0,06	KJ30X35X17	40	NTN			
	35,000	16,800	0,02	KV30X35X17	40	NTN			
	35,000	17,000	0,10	1R30X35X17	55	NTN			
	35,000	18,000	0,11	1R30X35X18	55	NTN			
	35,000	19,800	0,08	K30X35X20	40	NTN			
35,000	19,800	0,07	KJ30X35X20	40	NTN				
35,000	20,000	0,12	1R30X35X20	55	NTN				
35,000	20,500	0,08	1R30X35X20.5	55	NTN				
35,000	21,000	0,08	1R30X35X21	55	NTN				
35,000	21,800	0,03	KJ30X35X21.8	40	NTN				

								Brands	
d	D	B	Kg	Reference					
30,000	35,000	22,800	0,04	K30X35X22.8	40	NTN			
	35,000	23,000	0,09	1R30X35X23	55	NTN			
	35,000	24,800	0,05	GK30X35X24.8	40	NTN			
	35,000	24,800	0,06	K30X35X24.8	40	NTN			
	35,000	24,800	0,08	KJ30X35X24.8	40	NTN			
	35,000	25,000	0,05	1R30X35X25	55	NTN			
	35,000	25,800	0,07	K30X35X26ZW	40	NTN			
	35,000	25,800	0,09	KJ30X35X25.8	40	NTN			
	35,000	26,000	0,10	1R30X35X26	55	NTN			
	35,000	26,800	0,10	K30X35X27	40	NTN			
	35,000	26,800	0,09	KJ30X35X27	40	NTN			
	35,000	27,100	0,16	1R30X35X27.1	55	NTN			
	35,000	29,000	0,06	1R30X35X29	55	NTN			
	35,000	29,800	0,07	KJ30X35X29.8	40	NTN			
	35,000	30,000	0,18	1R30X35X30	55	NTN			
	35,000	31,400	0,19	1R30X35X31.4	55	NTN			
	35,000	32,000	0,13	1R30X35X32	55	NTN			
	35,000	33,500	0,13	1R30X35X33.5	55	NTN			
	35,000	35,000	0,14	1R30X35X35	55	NTN			
	35,000	36,500	0,15	1R30X35X36.5	55	NTN			
	35,000	38,000	0,23	1R30X35X38	55	NTN			
	36,000	12,500	0,06	K30X36X12.5	40	NTN			
	36,000	13,400	0,07	K30X36X13.4	40	NTN			
	36,000	13,800	0,03	GK30X36X14	40	NTN			
	36,000	13,800	0,06	KMJ30X36X14	40	NTN			
	36,000	24,000	0,06	1R30X36X24	55	NTN			
	36,000	28,000	0,07	1R30X36X28	55	NTN			
	37,000	10,000	0,03	HKS30X37X10	47	NTN			
	37,000	12,000	0,07	HK3012	47	NTN			
	37,000	12,000	0,05	HK3012D	47	NTN			
	37,000	13,800	0,07	PK30X37X13.8	40	NTN			
	37,000	15,800	0,09	K30X37X16	40	NTN			
	37,000	15,900	0,05	PK30X37X15.9	40	NTN			
	37,000	16,000	0,04	BK3016	48	NTN			
	37,000	16,000	0,03	HK3016C	47	NTN			
	37,000	16,000	0,03	HK3016LL	47	NTN			
	37,000	17,800	0,03	GK30X37X18	40	NTN			
	37,000	17,800	0,07	K30X37X18	40	NTN			
	37,000	18,000	0,05	1R30X37X18	55	NTN			
	37,000	18,000	0,10	HK3018L	47	NTN			
	37,000	19,800	0,11	K30X37X20	40	NTN			
	37,000	19,800	0,10	KMJ30X37X20	40	NTN			
	37,000	19,800	0,04	PK30X37X19.8	40	NTN			
	37,000	20,000	0,14	BK3020	48	NTN			
	37,000	20,000	0,04	HK3020	47	NTN			
	37,000	20,000	0,12	HK3020D	47	NTN			
	37,000	20,000	0,11	HK3020LL	47	NTN			
	37,000	22,000	0,12	1R30X37X22	55	NTN			
	37,000	22,800	0,09	K30X37X22.8	40	NTN			
	37,000	22,800	0,11	KJ30X37X22.8	40	NTN			
	37,000	26,000	0,12	BK3026	48	NTN			
	37,000	26,000	0,10	HK3026	47	NTN			
	37,000	26,000	0,16	HK3026D	47	NTN			
	37,000	27,300	0,13	KJ30X37X27.3	40	NTN			
	37,000	30,000	0,06	HKS30X37X30	47	NTN			
	37,000	38,000	0,08	BK3038ZWD	48	NTN			
	37,000	38,000	0,15	HK3038ZWD	47	NTN			
	37,000	45,500	0,27	HKS30X37X45.5ZW	47	NTN			
	38,000	13,800	0,09	PK30X38X13.8	40	NTN			
	38,000	15,800	0,10	PK30X38X15.8	40	NTN			
38,000	17,800	0,03	H30X38X17.8	40	NTN				
38,000	17,800	0,07	K30X38X18	40	NTN				

								Brands	
d	D	B	Kg	Reference					
30,000	38,000	17,800	0,04	PK30X38X17.8	40	NTN			
	38,000	20,000	0,13	1R30X38X20	55	NTN			
	38,000	23,000	0,17	RNA5905	41	NTN			
	38,000	23,800	0,16	K30X38X23.8	40	NTN			
	38,000	23,800	0,10	PK30X38X23.8	40	NTN			
	38,000	26,300	0,11	PK30X38X26.3	40	NTN			
	38,000	28,000	0,27	1R30X38X28	55	NTN			
	38,000	29,800	0,19	K30X38X29.8	40	NTN			
	38,000	37,800	0,29	PK30X38X37.8	40	NTN			
	40,000	13,000	0,04	HMK3013	47	NTN			
	40,000	15,000	0,13	HMK3015	47	NTN			
	40,000	17,000	0,12	RNA0-30X40X17	41	NTN			
	40,000	17,500	0,07	1R30X40X17.5	55	NTN			
	40,000	19,800	0,16	PK30X40X19.8	40	NTN			
	40,000	20,000	0,11	HMK3020	47	NTN			
	40,000	20,000	0,18	NK30/20R	41	NTN			
	40,000	20,000	0,13	NK30/20R1	41	NTN			
	40,000	23,000	0,06	HMK3023L	47	NTN			
	40,000	24,800	0,21	K30X40X24.8	40	NTN			
	40,000	24,800	0,20	PK30X40X24.8	40	NTN			
	40,000	25,000	0,21	HMK3025	47	NTN			
	40,000	26,000	0,14	HMK3026LL	47	NTN			
	40,000	26,000	0,28	RNA0-30X40X26ZW	41	NTN			
	40,000	27,000	0,22	1R30X40X27	55	NTN			
	40,000	28,800	0,07	PK30X40X28.8	40	NTN			
	40,000	30,000	0,09	HMK3030	47	NTN			
	40,000	30,000	0,09	HMK3030D	47	NTN			
	40,000	30,000	0,19	NK30/30R	41	NTN			
	40,000	31,000	0,17	HMK3031LL	47	NTN			
	40,000	37,800	0,29	KV30X40X37.8	40	NTN			
	40,000	50,000	0,19	KH3050	60	NTN			
	40,000	50,000	0,29	KH3050LL	60	NTN			
	40,000	60,000	0,20	NK30/30RD2	41	NTN			
	41,930	2,000	0,01	AKJ30X41.9	57	NTN			
	42,000	14,800	0,10	PK30X42X14.8	40	NTN			
	42,000	17,000	0,22	RNA4905L	41	NTN			
	42,000	17,000	0,21	RNA4905LL	41	NTN			
	42,000	17,000	0,12	RNA4905R	41	NTN			
	42,000	17,000	0,06	RNA4905RLL	41	NTN			
	42,000	17,000	0,06	RNA4905S	41	NTN			
	42,000	19,800	0,20	PK30X42X19.8	40	NTN			
	42,000	22,300	0,22	PK30X42X22.3	40	NTN			
	42,000	24,800	0,25	PK30X42X24.8	40	NTN			
	42,000	26,000	0,09	PK30X42X26	40	NTN			
	42,000	30,000	0,22	NK30X42X30	41	NTN			
	42,000	30,000	0,14	NKXR30	50	NTN			
	42,000	30,000	0,43	NKXR30Z	50	NTN			
	42,000	30,000	0,28	RNA6904R	41	NTN			
	42,000	30,000	0,33	RNA6905R	41	NTN			
	42,000	32,000	0,27	RNA0-30X42X32ZW	41	NTN			
	42,000	39,800	0,25	PK30X42X39.8	40	NTN			
	42,000	60,000	0,72	NKXR35D2	50	NTN			
	43,000	54,800	0,60	K30X43X54.8ZW	40	NTN			
	43,000	62,800	0,28	K30X43X62.8ZW	40	NTN			
	45,000	14,000	0,04	H30X45X14	40	NTN			
	45,000	20,000	0,32	NK35/20R+1R30X35X20	42	NTN			
	45,000	22,000	0,37	NKS30	41	NTN			
	45,000	25,800	0,11	PK30X45X25.8	40	NTN			
	45,000	26,000	0,16	NA0-20X45X26ZW	42	NTN			
	45,000	28,800	0,37	PK30X45X28.8	40	NTN			
45,000	30,000	0,33	NK35/30R+1R30X35X30	42	NTN				
45,000	65,000	0,53	KD304565	61	NTN				



								Brands	
d	D	B	Kg	Reference					
30,000	45,000	65,000	0,81	KD304565LL	61	NTN			
	47,000	1,000	0,02	AS1106	58	NTN			
	47,000	2,000	0,02	AXK1106	57	NTN			
	47,000	3,000	0,07	WS81106	58	NTN			
	47,000	3,800	0,01	ARXJ30X47X3.8	59	NTN			
	47,000	5,000	0,04	K81106	57	NTN			
	47,000	6,000	0,14	XS30X47X6	58	NTN			
	47,000	11,000	0,17	81106	56	NTN			
	47,000	17,000	0,35	NA4906LL	42	NTN			
	47,000	17,000	0,31	NA4906R	42	NTN			
	47,000	17,000	0,29	NK30X47X17	41	NTN			
	47,000	23,000	0,42	NA5906	42	NTN			
	47,000	23,000	0,45	NK1A5906A	53	NTN			
	47,000	30,000	0,55	NA6906R	42	NTN			
	47,000	30,000	0,43	NKX30	49	NTN			
	47,000	30,000	0,44	NKX30Z	49	NTN			
	48,000	3,300	0,01	ARXJ30X48X3.3	59	NTN			
	48,000	5,500	0,05	AKJ30X48X5.5	57	NTN			
	49,000	8,800	0,05	ARXJ30X49X8.8	59	NTN			
	50,000	17,000	0,36	NK30X50X17N	41	NTN			
	50,800	84,100	0,62	CR32	44	NTN			
	50,800	84,100	0,62	CR32X	44	NTN			
	52,000	4,250	0,13	WS81206	58	NTN			
	52,000	7,500	0,11	K81206	57	NTN			
	52,000	16,000	0,95	81206	56	NTN			
	52,000	16,000	0,46	RNAB205	43-A	NTN			
	52,000	16,000	0,15	RNAB205X	43-A	NTN			
	52,000	17,800	0,18	RNA2205LL	41	NTN			
	52,000	17,800	0,53	RNA2205XLL	41	NTN			
	52,000	30,000	0,37	NKXR35	50	NTN			
	53,000	12,000	0,26	ARX30X53X12	59	NTN			
	55,000	21,000	0,61	NK30X55X21	41	NTN			
	57,150	84,100	0,75	CR36X	44	NTN			
	58,000	20,000	0,26	ARX30X58X20	59	NTN			
	59,300	3,000	0,14	XS30X59.3X3	58	NTN			
	59,900	12,000	0,32	ARX30X59.9X12	59	NTN			
	60,000	5,500	0,13	K89306	57	NTN			
	60,000	6,250	0,48	89306	56	NTN			
	60,000	6,250	0,20	WS89306	58	NTN			
	62,000	20,000	1,00	NA2206LL	43	NTN			
	62,000	20,000	0,64	NA2206XLL	43	NTN			
	62,000	29,000	1,41	NATR30	45	NTN			
	62,000	29,000	1,38	NATR30LL	45-A	NTN			
	62,000	29,000	1,41	NATR30X	45	NTN			
	62,000	29,000	0,46	NATR30X62X29	45	NTN			
	62,000	29,000	1,38	NATR30XLL	45-A	NTN			
	62,000	29,000	0,48	NATV30	46	NTN			
	62,000	29,000	1,41	NATV30LL	46	NTN			
	62,000	29,000	1,46	NATV30X	46	NTN			
	62,000	29,000	1,42	NATV30XLL	46	NTN			
	62,000	29,000	0,46	NUTR206	52	NTN			
	62,000	29,000	1,39	NUTR206X	52	NTN			
	62,000	50,000	1,25	ARN3062	54	NTN			
	62,000	80,000	1,60	KRV62	44	NTN			
	62,000	80,000	2,40	KRV62LL	44	NTN			
	62,000	80,000	1,60	KRV62X	44	NTN			
	62,000	80,000	2,40	KRV62XLL	44	NTN			
	70,000	29,000	0,70	ARX30X70X29	59	NTN			
	70,000	116,000	2,41	ARX30X70X116	59	NTN			
	70,000	145,000	3,49	ARX30X70X145	59	NTN			
	72,000	29,000	2,08	NUTR306	52	NTN			
	72,000	29,000	2,10	NUTR306X	52	NTN			

								Brands		
d	D	B	Kg	Reference						
30,000	72,000	80,000	3,12	KR72LL	44	NTN				
	72,000	80,000	2,09	KRV72	44	NTN				
	72,000	80,000	3,14	KRV72LL	44	NTN				
	72,000	80,000	1,05	KRV72X	44	NTN				
	80,000	100,000	4,65	KR80	44	NTN				
	80,000	100,000	3,10	KR80X	44	NTN				
	80,000	100,000	4,65	KR80XLL	44	NTN				
	80,000	100,000	3,10	KRT80LL	44	NTN				
	80,000	100,000	1,55	KRU80	44	NTN				
	80,000	100,000	3,10	KRU80LL	44	NTN				
	80,000	100,000	1,55	KRU80XLL	44	NTN				
	80,000	100,000	4,68	KRV80XLL	44	NTN				
	80,000	100,000	3,12	KRVT80LL	44	NTN				
	80,000	100,000	3,12	KRVT80XLL	44	NTN				
	80,000	100,000	1,56	KRVU80LL	44	NTN				
	80,000	100,000	1,56	KRVU80XLL	44	NTN				
	80,000	100,000	4,62	NUKR80	51	NTN				
	80,000	100,000	3,08	NUKRT80	51	NTN				
	80,000	100,000	4,62	NUKRT80X	51	NTN				
	80,000	100,000	1,54	NUKRU80	51	NTN				
	80,000	100,000	1,54	NUKRU80X	51	NTN				
	85,000	100,000	1,74	KR85X	44	NTN				
	85,000	100,000	1,74	KR85XLL	44	NTN				
	90,000	100,000	1,95	KR90X	44	NTN				
	90,000	100,000	1,95	KR90XLL	44	NTN				
	90,000	100,000	3,90	KRT90LL	44	NTN				
	90,000	100,000	1,95	KRU90LL	44	NTN				
	90,000	100,000	1,95	KRU90XLL	44	NTN				
	90,000	100,000	5,91	KRV90XLL	44	NTN				
	90,000	100,000	1,96	NUKRT90	51	NTN				
	90,000	100,000	1,96	NUKRT90X	51	NTN				
	90,000	311,000	13,48	ARX30X90X311	59	NTN				
	106,000	31,000	1,93	ARX30X106X31	59	NTN				
	114,000	172,000	20,84	ARX30X114X172	59	NTN				
	30,120	40,000	27,000	0,11	1R30.1X40X27	55	NTN			
	30,150	43,800	2,800	0,03	ARXJ30.1X43.8X2.8	59	NTN			
	30,500	47,000	1,000	0,02	AS30.5X47X1	58	NTN			
		50,000	16,000	0,23	NK30.5X50X16	41	NTN			
		50,000	17,000	0,25	NK30.5X50X17	41	NTN			
	31,000	35,000	18,300	0,03	KJ31X35X18.3	40	NTN			
		35,000	23,800	0,07	KV31X35X23.8	40	NTN			
		36,000	13,800	0,05	KV31X36X13.8	40	NTN			
		36,000	18,300	0,04	KJ31X36X18.3	40	NTN			
41,000		21,400	0,12	PK31X41X21.4	40	NTN				
42,100		10,000	0,09	NK31X42.1X10NR	41	NTN				
43,400		3,000	0,03	AKJ31X43.4	57	NTN				
46,000		3,300	0,03	ARXJ31X46X3.3	59	NTN				
31,200	35,200	4,800	0,01	K31.2X35.2X4.8	40	NTN				
31,700	41,200	38,100	0,29	PK31.7X41.2X38.1	40	NTN				
	76,200	32,000	2,51	NATR31.7X76.2X32	45	NTN				
31,750	38,000	30,000	0,08	1R31.7X38X30	55	NTN				
	38,100	25,650	0,14	M1-102416	55	NTN				
	38,100	32,000	0,25	M1-102420	55	NTN				
	41,275	38,100	0,23	PCJ202624	40	NTN				
	44,450	25,400	0,32	MR202816	41	NTN				

								Brands	
d	D	B	Kg	Reference					
31,750	44,450	31,750	0,14	MR202820	41	NTN			
	76,200	109,500	5,40	CRV48XLL	44	NTN			
	82,550	109,500	2,20	CRV52XLL	44	NTN			
	101,600	58,738	3,49	NACV64XLL	46	NTN			
31,830	59,000	3,500	0,05	XS31.8X59X3.5	58	NTN			
32,000	35,000	25,000	0,09	1R32X35X25	55	NTN			
	36,000	11,000	0,02	1R32X36X11	55	NTN			
	36,000	14,800	0,05	K32X36X15	40	NTN			
	36,000	25,700	0,05	KJ32X36X25.7	40	NTN			
	36,000	29,800	0,03	GK32X36X29.8	40	NTN			
	37,000	12,800	0,05	K32X37X13	40	NTN			
	37,000	16,800	0,08	K32X37X17	40	NTN			
	37,000	16,800	0,02	KJ32X37X17	40	NTN			
	37,000	20,000	0,12	1R32X37X20	55	NTN			
	37,000	23,300	0,05	KJ32X37X23.3	40	NTN			
	37,000	23,600	0,06	K32X37X23.6	40	NTN			
	37,000	23,800	0,09	K32X37X23.8	40	NTN			
	37,000	23,800	0,03	KV32X37X23.8	40	NTN			
	37,000	25,500	0,16	1R32X37X25.5	55	NTN			
	37,000	25,800	0,11	K32X37X26ZW	40	NTN			
	37,000	26,550	0,03	KJ32X37X26.5	40	NTN			
	37,000	26,800	0,10	K32X37X27	40	NTN			
	37,000	26,800	0,10	KJ32X37X27	40	NTN			
	37,000	29,800	0,10	KJ32X37X29.8	40	NTN			
	37,000	30,000	0,20	1R32X37X30	55	NTN			
	37,000	35,000	0,22	1R32X37X35	55	NTN			
	37,000	38,300	0,13	K32X37X38.3ZW	40	NTN			
	38,000	13,800	0,03	GK32X38X14	40	NTN			
	38,000	13,800	0,06	KMJ32X38X14	40	NTN			
	38,000	19,800	0,08	KJ32X38X20	40	NTN			
	38,000	23,800	0,10	KJ32X38X23.8	40	NTN			
	38,000	25,800	0,13	K32X38X26	40	NTN			
	38,000	28,100	0,04	KJ32X38X28.1	40	NTN			
	38,000	30,000	0,22	1R32X38X30	55	NTN			
	38,000	32,000	0,16	1R32X38X32	55	NTN			
	38,000	33,800	0,07	K32X38X33.8	40	NTN			
	38,000	35,800	0,07	K32X38X35.8ZW	40	NTN			
	39,000	15,800	0,10	K32X39X16	40	NTN			
	39,000	17,800	0,11	K32X39X18	40	NTN			
	39,000	19,800	0,12	K32X39X20	40	NTN			
	39,000	19,800	0,10	KJ32X39X20	40	NTN			
	39,000	34,000	0,21	HKS32X39X34	47	NTN			
	39,000	37,000	0,23	HKS32X39X37	47	NTN			
	40,000	17,800	0,08	PK32X40X17.8	40	NTN			
	40,000	18,800	0,04	KJ32X40X18.8	40	NTN			
	40,000	20,000	0,21	1R32X40X20	55	NTN			
	40,000	27,000	0,19	1R32X40X27	55	NTN			
40,000	30,500	0,31	1R32X40X30.5	55	NTN				
40,000	30,650	0,11	1R32X40X30.6	55	NTN				
40,000	35,800	0,19	PK32X40X35.8	40	NTN				
40,000	36,000	0,38	1R32X40X36	55	NTN				
40,000	49,200	0,30	KV32X40X49.2ZW	40	NTN				
41,000	17,800	0,05	H32X41X17.8	40	NTN				
41,000	17,800	0,13	PK32X41X17.8	40	NTN				
42,000	13,000	0,10	RNA0-32X42X13	41	NTN				
42,000	16,800	0,14	PK32X42X16.8	40	NTN				
42,000	20,000	0,07	NK32/20R	41	NTN				
42,000	26,000	0,07	HMK3226LL	47	NTN				
42,000	30,000	0,20	NK32/30R	41	NTN				
42,000	30,000	0,12	NK32X42X30	41	NTN				

								Brands	
d	D	B	Kg	Reference					
32,000	43,000	17,300	0,10	K32X43X17.3X3	40	NTN			
	43,000	22,400	0,07	PK32X43X22.4	40	NTN			
	44,000	2,000	0,02	AKJ32X44X2	57	NTN			
	44,000	17,800	0,19	PK32X44X17.8	40	NTN			
	44,000	32,500	0,11	PK32X44X32.5	40	NTN			
	45,000	17,000	0,22	RNA49/28R	41	NTN			
	45,000	23,000	0,22	RNA59/28	41	NTN			
	45,000	24,800	0,19	PK32X45X24.8	40	NTN			
	45,000	30,000	0,26	RNA69/28R	41	NTN			
	45,300	2,000	0,01	XS32X45.3X2	58	NTN			
	46,000	2,000	0,02	AKJ32X46X2	57	NTN			
	46,000	17,700	0,26	NK32X46X17.7	41	NTN			
	47,000	2,000	0,04	XS32X47X2	58	NTN			
	47,000	3,000	0,06	GS81106	58	NTN			
	47,000	3,000	0,04	XS32X47X3	58	NTN			
	47,000	20,000	0,34	NK37/20R+1R32X37X20	42	NTN			
	47,000	22,000	0,39	NKS32	41	NTN			
	47,000	30,000	0,51	NK37/30R+1R32X37X30	42	NTN			
	48,000	2,000	0,01	AKJ32X48X2	57	NTN			
	48,000	2,000	0,03	XS32X48X2	58	NTN			
	48,000	24,800	0,24	K32X48X24.8	40	NTN			
	52,000	4,250	0,08	GS81206	58	NTN			
	52,000	20,000	0,47	NA49/32R	42	NTN			
	52,000	27,000	0,43	NA59/32	42	NTN			
	52,000	36,000	0,88	NA69/32R	42	NTN			
	54,000	2,500	0,01	AKJ32X54X2.5	57	NTN			
	60,000	6,250	0,19	GS89306	58	NTN			
70,000	25,000	0,95	ARX32X70X25	59	NTN				
72,000	25,000	0,97	ARX32X72X25	59	NTN				
32,500	51,000	23,000	0,18	NK32.5X51X23	41	NTN			
	53,000	20,500	0,53	NK32.5X53X20.5	41	NTN			
	65,000	3,000	0,05	XS32.5X65X3	58	NTN			
33,000	37,000	25,800	0,05	GK33X37X25.8	40	NTN			
	37,000	25,800	0,07	KJ33X37X25.8	40	NTN			
	38,000	14,800	0,05	KJ33X38X14.8	40	NTN			
	38,000	16,300	0,06	KJ33X38X16.3	40	NTN			
	38,000	27,300	0,10	KJ33X38X27.3	40	NTN			
	38,000	30,300	0,08	K33X38X30.3	40	NTN			
	39,000	22,600	0,05	K33X39X22.6	40	NTN			
	39,000	32,000	0,16	1R33X39X32	55	NTN			
	40,000	25,000	0,08	1R33X40X25	55	NTN			
	41,000	19,800	0,05	H33X41X19.8	40	NTN			
	41,000	19,800	0,05	PK33X41X19.8	40	NTN			
	45,000	24,800	0,27	PK33X45X24.8	40	NTN			
	47,000	17,000	0,28	NK33X47X17NR	41	NTN			
	49,000	2,000	0,01	AKJ33X49X2	57	NTN			
	52,000	4,000	0,07	ARXJ33X52X4	59	NTN			
57,700	5,800	0,17	ARXJ33X57.7X5.8	59	NTN				
33,338	41,275	25,650	0,09	M1-112616	55	NTN			
	41,275	32,000	0,12	M1-112620	55	NTN			
33,500	47,000	14,000	0,20	NK33.5X47X14	41	NTN			
34,000	39,000	22,800	0,03	KJ34X39X22.8	40	NTN			
	39,000	24,000	0,16	1R34X39X24	55	NTN			
	39,000	27,300	0,03	KJ34X39X27.3	40	NTN			
	39,000	36,300	0,08	GK34X39X36.3	40	NTN			
	40,000	10,600	0,03	1R34X40X10.6	55	NTN			
	40,000	17,800	0,09	KJ34X40X17.8	40	NTN			



								Brands		
d	D	B	Kg	Reference						
34,000	40,000	19,800	0,06	KJ34X40X19.8	40	NTN				
	40,000	23,800	0,04	KJ34X40X23.8	40	NTN				
	40,000	25,800	0,10	KJ34X40X25.8	40	NTN				
	40,000	39,300	0,20	KV34X40X39.3ZW	40	NTN				
	40,000	49,800	0,14	GK34X40X49.8	40	NTN				
	42,000	19,800	0,02	H34X42X19.8	40	NTN				
	42,000	19,800	0,09	PK34X42X19.8	40	NTN				
	42,000	21,800	0,03	H34X42X21.8	40	NTN				
	43,000	19,800	0,02	H34X43X19.8	40	NTN				
	43,000	20,800	0,05	H34X43X20.8	40	NTN				
	43,000	29,800	0,08	PK34X43X29.8	40	NTN				
	46,000	15,800	0,17	PK34X46X15.8	40	NTN				
	49,000	15,300	0,09	K34X49X15.3	40	NTN				
	53,500	2,500	0,02	AKJ34X53.5X2.5	57	NTN				
	80,000	28,000	1,45	ARX34X80X28	59	NTN				
	34,500	50,700	2,000	0,01	AKJ34.5X50.7X2	57	NTN			
	34,600	51,100	2,000	0,02	AKJ34.6X51.1X2	57	NTN			
34,667	40,000	32,000	0,16	1R34.6X40X32	55	NTN				
	40,000	43,000	0,21	1R34.6X40X43	55	NTN				
34,925	44,450	25,650	0,12	M1-122816	55	NTN				
	44,450	31,750	0,22	PCJ222820	40	NTN				
	44,450	32,000	0,29	M1-122820	55	NTN				
	47,625	25,400	0,11	MR223016	41	NTN				
	47,625	31,750	0,43	MR223020	41	NTN				
	48,925	19,800	0,28	PK34.9X48.9X19.8	40	NTN				
	48,925	24,800	0,21	K34.9X48.9X24.8	40	NTN				
	48,925	27,300	0,37	PK34.9X48.9X27.3	40	NTN				
	48,925	32,300	0,44	PK34.9X48.9X32.3	40	NTN				
	50,925	29,700	0,16	PK34.9X50.9X29.7	40	NTN				
	50,925	45,000	0,47	K34.9X50.9X45	40	NTN				
	50,925	45,000	0,70	PK34.9X50.9X45	40	NTN				
35,000	39,000	22,300	0,07	KV35X39X22.3	40	NTN				
	39,000	23,800	0,05	K35X39X23.8	40	NTN				
	39,000	23,800	0,07	KJ35X39X23.8	40	NTN				
	39,000	34,000	0,04	K35X39X34ZW	40	NTN				
	40,000	12,500	0,06	1R35X40X12.5	55	NTN				
	40,000	12,800	0,06	K35X40X13	40	NTN				
	40,000	16,500	0,04	1R35X40X16.5	55	NTN				
	40,000	16,800	0,08	K35X40X17	40	NTN				
	40,000	17,000	0,11	1R35X40X17	55	NTN				
	40,000	17,800	0,08	K35X40X17.8	40	NTN				
	40,000	19,000	0,09	K35X40X19	40	NTN				
	40,000	20,000	0,13	1R35X40X20	55	NTN				
	40,000	20,500	0,14	1R35X40X20.5	55	NTN				
	40,000	21,800	0,09	KJ35X40X21.8	40	NTN				
	40,000	22,800	0,06	K35X40X22.8	40	NTN				
	40,000	22,800	0,08	KJ35X40X22.8	40	NTN				
	40,000	23,800	0,06	KJ35X40X23.8	40	NTN				
	40,000	24,000	0,09	KJ35X40X24	40	NTN				
	40,000	25,800	0,12	K35X40X26ZW	40	NTN				
	40,000	25,800	0,10	KJ35X40X25.8	40	NTN				
	40,000	26,800	0,06	GK35X40X26.8	40	NTN				
	40,000	26,800	0,04	K35X40X27	40	NTN				
	40,000	26,800	0,10	KJ35X40X27	40	NTN				
	40,000	28,700	0,07	GK35X40X28.7	40	NTN				
	40,000	28,700	0,11	KJ35X40X28.7	40	NTN				
	40,000	29,800	0,05	K35X40X30ZW	40	NTN				

								Brands	
d	D	B	Kg	Reference					
35,000	40,000	30,000	0,21	1R35X40X30	55	NTN			
	40,000	31,000	0,12	KJ35X40X31	40	NTN			
	40,000	31,800	0,12	KJ35X40X31.8	40	NTN			
	40,000	33,500	0,08	1R35X40X33.5	55	NTN			
	40,000	34,000	0,15	1R35X40X34	55	NTN			
	40,000	34,800	0,12	KJ35X40X34.8	40	NTN			
	40,000	35,800	0,18	K35X40X35.8ZWS	40	NTN			
	40,000	39,800	0,15	KV35X40X39.8ZW	40	NTN			
	40,000	40,000	0,27	1R35X40X40	55	NTN			
	41,000	12,000	0,05	K35X41X12	40	NTN			
	41,000	13,600	0,05	K35X41X13.6	40	NTN			
	41,000	13,800	0,05	K35X41X14	40	NTN			
	41,000	14,800	0,08	K35X41X15	40	NTN			
	41,000	23,800	0,13	K35X41X23.8	40	NTN			
	41,000	23,800	0,11	KJ35X41X23.8	40	NTN			
	41,000	25,800	0,04	KJ35X41X25.8	40	NTN			
	41,000	27,800	0,04	KJ35X41X27.8	40	NTN			
	41,000	28,800	0,13	KJ35X41X28.8	40	NTN			
	42,000	10,000	0,04	HKS35X42X10	47	NTN			
	42,000	12,000	0,08	HK3512	47	NTN			
	42,000	15,800	0,11	K35X42X16	40	NTN			
	42,000	16,000	0,07	HK3516	47	NTN			
	42,000	16,000	0,07	HK3516LL	47	NTN			
	42,000	17,800	0,12	K35X42X18	40	NTN			
	42,000	18,000	0,12	HK3518L	47	NTN			
	42,000	19,800	0,14	K35X42X20	40	NTN			
	42,000	19,800	0,03	KJ35X42X20	40	NTN			
	42,000	19,800	0,04	KV35X42X20	40	NTN			
	42,000	19,800	0,11	PK35X42X19.8	40	NTN			
	42,000	20,000	0,19	1R35X42X20	55	NTN			
	42,000	20,000	0,06	BK3520	48	NTN			
	42,000	20,000	0,13	HK3520	47	NTN			
	42,000	20,000	0,13	HK3520D	47	NTN			
	42,000	20,000	0,08	HK3520LL	47	NTN			
	42,000	21,000	0,14	1R35X42X21	55	NTN			
	42,000	22,500	0,07	1R35X42X22.5	55	NTN			
	42,000	23,000	0,07	1R35X42X23	55	NTN			
	42,000	27,000	0,26	1R35X42X27	55	NTN			
	42,000	29,800	0,20	K35X42X30	40	NTN			
	42,000	29,800	0,05	KJ35X42X30	40	NTN			
	42,000	30,000	0,22	NK35X42X30	41	NTN			
	42,000	36,000	0,35	1R35X42X36	55	NTN			
	42,000	37,000	0,24	1R35X42X37	55	NTN			
	42,000	40,000	0,13	1R35X42X40	55	NTN			
	42,000	80,000	0,26	1R35X42X80	55	NTN			
	43,000	18,800	0,09	PK35X43X18.8	40	NTN			
	43,000	22,000	0,25	1R35X43X22	55	NTN			
	43,000	33,500	0,13	1R35X43X33.5	55	NTN			
	44,000	35,600	0,28	PK35X44X35.6	40	NTN			
	45,000	12,000	0,11	HMK3512	47	NTN			
	45,000	13,000	0,05	RNA0-35X45X13	41	NTN			
	45,000	15,000	0,14	HMK3515	47	NTN			
45,000	17,000	0,07	RNA0-35X45X17	41	NTN				
45,000	18,000	0,16	HMK3518L	47	NTN				
45,000	20,000	0,12	HMK3520	47	NTN				
45,000	20,000	0,21	NK35/20R	41	NTN				
45,000	24,800	0,17	K35X45X24.8	40	NTN				
45,000	25,000	0,23	HMK3525	47	NTN				
45,000	26,000	0,32	RNA0-35X45X26ZW	41	NTN				
45,000	28,000	0,08	HMK3528L	47	NTN				
45,000	30,000	0,28	HMK3530	47	NTN				
45,000	30,000	0,31	NK35/30R	41	NTN				

								Brands	
d	D	B	Kg	Reference					
35,000	45,000	31,000	0,28	HMK3531LL	47	NTN			
	46,500	1,500	0,02	AS35X46.5X1.5	58	NTN			
	47,000	2,000	0,02	AKJ35X47X2	57	NTN			
	47,000	17,000	0,08	RNA4906L	41	NTN			
	47,000	17,000	0,24	RNA4906LL	41	NTN			
	47,000	17,000	0,14	RNA4906R	41	NTN			
	47,000	17,000	0,22	RNA4906RLL	41	NTN			
	47,000	23,000	0,28	RNA5906	41	NTN			
	47,000	24,800	0,28	PK35X47X24.8	40	NTN			
	47,000	29,800	0,34	K35X47X29.8	40	NTN			
	47,000	29,800	0,24	PK35X47X29.8	40	NTN			
	47,000	30,000	0,13	NK35X47X30	41	NTN			
	47,000	30,000	0,51	NKXR35Z	50	NTN			
	47,000	30,000	0,13	RNA6906R	41	NTN			
	47,000	32,000	0,36	RNA0-35X47X32ZW	41	NTN			
	47,000	35,800	0,13	PK35X47X35.8	40	NTN			
	48,000	12,500	0,24	1R35X48X12.5	55	NTN			
	48,000	30,800	0,36	PK35X48X30.8	40	NTN			
	49,000	24,800	0,34	PK35X49X24.8	40	NTN			
	50,000	17,000	0,12	NA0-25X50X17	42	NTN			
	50,000	20,000	0,37	NK40/20R+1R35X40X20	42	NTN			
	50,000	22,000	0,42	NKS35	41	NTN			
	50,000	30,000	0,56	NK40/30R+1R35X40X30	42	NTN			
	50,000	39,800	0,37	PK35X50X39.8	40	NTN			
	51,000	20,800	0,22	PK35X51X20.8	40	NTN			
	52,000	0,800	0,02	AS35X52X0.8	58	NTN			
	52,000	1,000	0,03	AS1107	58	NTN			
	52,000	2,000	0,03	AXK1107	57	NTN			
	52,000	2,000	0,03	XS35X52X2	58	NTN			
	52,000	3,500	0,09	WS81107	58	NTN			
	52,000	5,000	0,05	K81107	57	NTN			
	52,000	12,000	0,22	81107	56	NTN			
	52,000	30,000	0,17	NKX35	49	NTN			
	52,000	30,000	0,51	NKX35Z	49	NTN			
	52,000	33,000	0,23	NK35X52X33	41	NTN			
	52,000	70,000	0,41	KD355270LL	61	NTN			
	53,000	2,800	0,04	ARXJ35X53X2.8	59	NTN			
	53,000	3,000	0,05	ARXJ35X53X3	59	NTN			
	55,000	17,800	0,16	K35X55X17.8	40	NTN			
	55,000	20,000	0,39	NA0-25X55X20	42	NTN			
	55,000	20,000	0,52	NA4907R	42	NTN			
	55,000	21,000	0,38	NA4907LL	42	NTN			
	55,000	27,000	0,70	NA5907	42	NTN			
	55,000	27,000	0,23	NK15X55X27	41	NTN			
	55,000	27,000	0,74	NK1A5907A	53	NTN			
	55,000	36,000	0,94	NA6907R	42	NTN			
	56,000	5,000	0,11	XS35X56X5	58	NTN			
	60,000	1,000	0,03	AS35X60X1	58	NTN			
	62,000	5,250	0,24	WS81207	58	NTN			
	62,000	5,250	0,17	XS35X62X5.2	58	NTN			
	62,000	7,500	0,13	K81207	57	NTN			
	62,000	16,500	0,07	ARXJ35X62X16.5	59	NTN			
	62,000	18,000	0,25	81207	56	NTN			
	62,000	19,800	0,88	RNA2206LL	41	NTN			
	62,000	19,800	0,58	RNA2206XLL	41	NTN			
	62,000	80,000	2,39	NUKR62	51	NTN			
	62,000	80,000	2,39	NUKR62X	51	NTN			
	68,000	6,000	0,13	K89307	57	NTN			
	68,000	7,000	0,28	WS89307	58	NTN			
	68,000	20,000	0,68	89307	56	NTN			
	70,000	54,000	1,86	ARN3570	54	NTN			
	72,000	23,000	1,01	NA2207LL	43	NTN			

								Brands		
d	D	B	Kg	Reference						
35,000	72,000	23,000	0,51	NA2207XLL	43	NTN				
	72,000	29,000	1,28	NATR35	45	NTN				
	72,000	29,000	1,88	NATR35LL	45-A	NTN				
	72,000	29,000	0,64	NATR35X	45	NTN				
	72,000	29,000	1,88	NATR35XLL	45-A	NTN				
	72,000	29,000	1,31	NATV35	46	NTN				
	72,000	29,000	1,91	NATV35LL	46	NTN				
	72,000	29,000	1,31	NATV35X	46	NTN				
	72,000	29,000	1,92	NATV35XLL	46	NTN				
	72,000	29,000	0,63	NUTR207	52	NTN				
	72,000	29,000	1,89	NUTR207X	52	NTN				
	80,000	29,000	2,51	NUTR307	52	NTN				
	80,000	29,000	2,51	NUTR307X	52	NTN				
	116,000	30,000	1,55	ARX35X116X30	59	NTN				
	160,000	305,000	44,74	ARX35X160X305	59	NTN				
	35,100	54,000	3,400	0,02	ARXJ35.1X54X3.4	59	NTN			
	35,500	43,500	19,800	0,14	PK35.5X43.5X19.8	40	NTN			
	35,600	52,000	24,000	0,16	NK35.6X52X24	41	NTN			
	36,000	40,000	12,000	0,04	1R36X40X11.5	55	NTN			
		40,000	12,000	0,02	1R36X40X12	55	NTN			
		41,000	14,800	0,06	KJ36X41X14.8	40	NTN			
		41,000	18,300	0,05	KJ36X41X18.3	40	NTN			
		41,000	20,300	0,03	KJ36X41X20.3	40	NTN			
		41,000	21,500	0,11	K36X41X21.5	40	NTN			
41,000		25,300	0,10	KJ36X41X25.3	40	NTN				
41,000		30,300	0,06	K36X41X30.3	40	NTN				
41,000		30,300	0,12	KJ36X41X30.3	40	NTN				
41,000		70,600	0,16	GK36X41X70.6	40	NTN				
42,000		12,000	0,07	HKS36X42X12	47	NTN				
42,000		14,800	0,02	KM36X42X14.8	40	NTN				
44,000		26,000	0,30	1R36X44X26	55	NTN				
45,000		22,800	0,06	H36X45X22.8	40	NTN				
47,000		11,000	0,16	NK36X47X11NR	41	NTN				
48,000		22,400	0,25	PK36X48X22.4	40	NTN				
48,000		24,900	0,29	PK36X48X24.9	40	NTN				
52,000		2,000	0,03	AKJ36X52X2	57	NTN				
62,000	29,500	0,37	NK16X62X29.5	41	NTN					
100,000	120,000	9,24	NUKR100	51	NTN					
100,000	120,000	9,24	NUKR100X	51	NTN					
100,000	120,000	3,08	NUKRT100	51	NTN					
100,000	120,000	3,08	NUKRT100X	51	NTN					
100,000	120,000	3,08	NUKR100	51	NTN					
120,000	184,000	12,54	ARX36X120X184	59	NTN					
120,000	189,000	12,56	ARX36X120X189	59	NTN					
120,000	213,000	13,98	ARX36X120X213	59	NTN					
160,000	94,000	10,58	ARX36X160X94	59	NTN					
36,100	50,000	25,500	0,17	1R36.1X50X25.5	55	NTN				
36,200	44,450	30,800	0,38	1R36.2X44.4X30.8	55	NTN				
36,400	54,000	3,300	0,02	ARXJ36.4X54X3.3	59	NTN				
37,000	42,000	12,800	0,02	K37X42X13	40	NTN				
	42,000	14,800	0,02	KJ37X42X14.8	40	NTN				
	42,000	16,800	0,05	K37X42X17	40	NTN				
	42,000	16,800	0,07	KJ37X42X17	40	NTN				
	42,000	23,100	0,07	KJ37X42X23.1	40	NTN				



										Brands		
d	D	B	Kg	Reference								
37,000	42,000	23,800	0,06	K37X42X23.8	40	NTN						
	42,000	24,800	0,04	GK37X42X24.8	40	NTN						
	42,000	26,800	0,11	GK37X42X27	40	NTN						
	42,000	26,800	0,12	K37X42X27	40	NTN						
	42,000	26,800	0,11	KJ37X42X27	40	NTN						
	42,000	27,800	0,08	K37X42X27.8	40	NTN						
	42,000	29,800	0,04	KJ37X42X29.8	40	NTN						
	43,000	17,800	0,03	KJ37X43X17.8	40	NTN						
	43,000	22,600	0,03	K37X43X22.6	40	NTN						
	43,000	22,800	0,11	KJ37X43X22.8	40	NTN						
	43,000	33,300	0,19	KV37X43X33.3	40	NTN						
	44,000	17,800	0,08	K37X44X18	40	NTN						
	45,000	24,800	0,11	K37X45X24.8	40	NTN						
	47,000	13,000	0,05	RNA0-37X47X13	41	NTN						
	47,000	20,000	0,28	NK37/20R	41	NTN						
	47,000	24,800	0,25	PK37X47X24.8	40	NTN						
	47,000	30,000	0,21	HMK3730	47	NTN						
	47,000	30,000	0,32	NK37/30R	41	NTN						
	48,900	1,600	0,03	AS37X48.9X1.6	58	NTN						
	48,900	1,700	0,01	AS37X48.9X1.7	58	NTN						
	48,900	1,800	0,03	AS37X48.9X1.8	58	NTN						
	48,900	1,900	0,04	XS37X48.9X1.9	58	NTN						
	48,900	2,000	0,04	XS37X48.9X2	58	NTN						
	52,000	3,500	0,08	GS81107	58	NTN						
	52,000	18,000	0,25	RNA0-37X52X18	41	NTN						
	52,000	22,000	0,29	NKS37	41	NTN						
	52,000	26,800	0,14	PK37X52X26.8	40	NTN						
	56,000	3,710	0,05	ARXJ37X56X3.7	59	NTN						
	59,000	2,800	0,06	ARXJ37X59X2.8	59	NTN						
	62,000	5,250	0,23	GS81207	58	NTN						
	68,000	7,000	0,40	GS89307	58	NTN						
	37,100	52,000	2,800	0,03	ARXJ37.1X52X2.8	59	NTN					
37,500	58,000	4,800	0,06	ARXJ37.5X58X4.8	59	NTN						
37,800	43,000	30,020	0,16	1R37.8X43X30	55	NTN						
38,000	43,000	16,800	0,06	K38X43X17	40	NTN						
	43,000	20,000	0,15	1R38X43X20	55	NTN						
	43,000	21,800	0,06	KJ38X43X21.8	40	NTN						
	43,000	24,800	0,11	KV38X43X24.8	40	NTN						
	43,000	25,800	0,11	KBK38X43X25.8	40	NTN						
	43,000	25,800	0,10	KJ38X43X25.8	40	NTN						
	43,000	26,020	0,13	1R38X43X26	55	NTN						
	43,000	26,800	0,04	K38X43X27	40	NTN						
	43,000	27,900	0,12	KJ38X43X27.9	40	NTN						
	43,000	28,800	0,05	K38X43X28.8	40	NTN						
	43,000	29,800	0,12	KJ38X43X29.8	40	NTN						
	43,000	30,000	0,21	1R38X43X30	55	NTN						
	43,000	36,000	0,18	K38X43X36ZW	40	NTN						
	44,000	19,800	0,07	KV38X44X19.8	40	NTN						
	44,000	22,300	0,09	KV38X44X22.3	40	NTN						
	44,000	28,800	0,09	KJ38X44X28.8	40	NTN						
	46,000	19,800	0,14	KMJ38X46X20	40	NTN						
	46,000	19,800	0,05	PK38X46X19.8	40	NTN						
	46,000	31,800	0,04	GK38X46X32	40	NTN						
	46,000	31,800	0,26	K38X46X32	40	NTN						
	47,000	19,800	0,02	H38X47X19.8	40	NTN						
	48,000	13,000	0,14	HKS38X48X13	47	NTN						
	48,000	20,000	0,20	HMK3820	47	NTN						
	48,000	20,000	0,22	NK38/20R	41	NTN						

										Brands	
d	D	B	Kg	Reference							
38,000	48,000	22,800	0,05	H38X48X22.8	40	NTN					
	48,000	22,800	0,23	PK38X48X22.8	40	NTN					
	48,000	25,000	0,08	HMK3825	47	NTN					
	48,000	28,000	0,28	HMK3828L	47	NTN					
	48,000	30,000	0,20	HMK3830	47	NTN					
	48,000	30,000	0,33	NK38/30R	41	NTN					
	48,000	31,000	0,10	HMK3831LL	47	NTN					
	51,800	2,800	0,04	ARXJ38X51.8X2.8	59	NTN					
	52,000	3,500	0,02	XS38X52X3.5	58	NTN					
	52,000	27,000	0,14	NK38X52X27	41	NTN					
	52,000	48,800	0,70	PK38X52X48.8	40	NTN					
	53,000	20,000	0,13	NK43/20R+1R38X43X20	42	NTN					
	53,000	29,800	0,31	PK38XPK53X29.8	40	NTN					
	53,000	30,000	0,60	NK43/30R+1R38X43X30	42	NTN					
	54,000	34,800	0,20	PK38X54X34.8	40	NTN					
	57,000	2,500	0,03	AKJ38X57X2.5	57	NTN					
	57,000	3,800	0,02	ARXJ38X57X3.9	59	NTN					
	57,000	4,200	0,05	ARXJ38X57X4.2	59	NTN					
	60,000	7,500	0,15	ARXJ38X60X7.5	59	NTN					
	69,000	5,700	0,14	ARXJ38X69X5.7	59	NTN					
	80,000	28,500	0,85	ARX38X80X28.5	59	NTN					
	80,000	100,000	4,65	KR80LL	44	NTN					
	80,000	100,000	4,65	KRV80	44	NTN					
	80,000	100,000	4,68	KRV80LL	44	NTN					
	80,000	100,000	3,12	KRV80X	44	NTN					
	85,000	100,000	3,48	KR85	44	NTN					
	85,000	100,000	3,48	KR85LL	44	NTN					
	90,000	100,000	3,90	KR90	44	NTN					
	90,000	100,000	3,90	KR90LL	44	NTN					
	90,000	100,000	2,32	KRV90	44	NTN					
	90,000	100,000	2,32	KRV90LL	44	NTN					
	90,000	100,000	1,97	KRV90X	44	NTN					
	92,000	35,000	2,76	ARX38X92X35	59	NTN					
128,000	45,000	3,70	ARX38X128X45	59	NTN						
38,100	44,450	25,650	0,16	M1-142816	55	NTN					
	47,600	31,700	0,19	PK38.1X47.6X31.7	40	NTN					
	47,600	34,900	0,12	HKS38.1X47.6X34.9	47	NTN					
	47,600	38,100	0,36	PK38.1X47.6X38.1	40	NTN					
	47,625	25,400	0,22	PCJ243016	40	NTN					
	47,625	31,750	0,19	PCJ243020	40	NTN					
	47,625	35,750	0,26	HKS38.1X47.6X35.7	47	NTN					
	47,625	38,100	0,34	PCJ243024	40	NTN					
	52,388	25,400	0,42	MR243316	41	NTN					
	52,388	31,750	0,53	MR243320	41	NTN					
	54,100	24,800	0,14	PK38.1X54.1X24.8	40	NTN					
	54,100	29,800	0,50	PK38.1X54.1X29.8	40	NTN					
	54,100	31,700	0,55	PK38.1X54.1X31.7	40	NTN					
	54,100	34,800	0,39	PK38.1X54.1X34.8	40	NTN					
	54,100	39,800	0,67	PK38.1X54.1X39.8	40	NTN					
101,600	147,600	6,67	CRV64XLL	44	NTN						
38,500	53,500	3,000	0,04	ARXJ38.5X53.5X3	59	NTN					
	56,500	4,200	0,08	ARXJ38.5X56.5X4.2	59	NTN					
39,000	44,000	18,300	0,06	KJ39X44X18.3	40	NTN					
	44,000	23,800	0,04	K39X44X23.8	40	NTN					
	44,000	24,800	0,10	KJ39X44X24.8	40	NTN					
	44,000	25,800	0,07	GK39X44X25.8	40	NTN					
	44,000	30,800	0,08	GK39X44X30.8	40	NTN					
	44,000	30,800									

										Brands	
d	D	B	Kg	Reference							
39,000	54,000	2,000	0,02	AKJ39X54X2	57	NTN					
	54,000	22,800	0,12	PK39X54X22.8	40	NTN					
	55,000	20,500	0,37	PK39X55X20.5	40	NTN					
	55,000	24,800	0,27	K39X55X24.8	40	NTN					
	55,000	25,000	0,45	PK39X55X25	40	NTN					
	62,300	4,000	0,10	ARXJ39X62.3X4	59	NTN					
39,300	45,000	22,500	0,20	1R39.3X45X22.5	55	NTN					
	45,000	24,500	0,22	1R39.3X45X24.5	55	NTN					
39,500	45,000	28,000	0,08	1R39.5X45X28	55	NTN					
	45,000	32,000	0,27	1R39.5X45X32	55	NTN					
	62,000	2,500	0,07	XS39.5X62X2.5	58	NTN					
39,688	47,625	32,000	0,14	M1-153020	55	NTN					
39,800	53,000	4,000	0,06	XS39.8X53X4	58	NTN					
40,000	44,000	22,800	0,17	KV40X44X22.8	40	NTN					
	44,000	34,600	0,10	K40X44X34.6ZW	40	NTN					
	45,000	11,500	0,03	1R40X45X11.5	55	NTN					
	45,000	12,000	0,06	1R40X45X12	55	NTN					
	45,000	12,800	0,07	K40X45X13	40	NTN					
	45,000	16,500	0,04	1R40X45X16.5	55	NTN					
	45,000	16,800	0,09	K40X45X17	40	NTN					
	45,000	17,000	0,13	1R40X45X17	55	NTN					
	45,000	20,000	0,15	1R40X45X20	55	NTN					
	45,000	20,500	0,16	1R40X45X20.5	55	NTN					
	45,000	20,800	0,11	K40X45X21	40	NTN					
	45,000	22,000	0,06	1R40X45X22	55	NTN					
	45,000	22,000	0,11	K40X45X22	40	NTN					
	45,000	22,300	0,11	KJ40X45X22.3	40	NTN					
	45,000	22,800	0,06	1R40X45X22.8	55	NTN					
	45,000	24,800	0,04	KJ40X45X24.8	40	NTN					
	45,000	25,000	0,13	1R40X45X25	55	NTN					
	45,000	25,500	0,20	1R40X45X25.5	55	NTN					
	45,000	26,500	0,07	1R40X45X26.5	55	NTN					
	45,000	26,800	0,14	K40X45X27	40	NTN					
	45,000	26,800	0,04	KJ40X45X26.8	40	NTN					
	45,000	29,800	0,05	K40X45X29.8	40	NTN					
	45,000	29,800	0,13	KJ40X45X29.8	40	NTN					
	45,000	30,000	0,23	1R40X45X30	55	NTN					
	45,000	31,800	0,05	K40X45X31.8ZW	40	NTN					
	45,000	32,500	0,08	1R40X45X32.5	55	NTN					
	45,000	32,600	0,11	K40X45X32.6	40	NTN					
	45,000	34,000	0,26	1R40X45X34	55	NTN					
	45,000	34,550	0,15	K40X45X34.5	40	NTN					
	45,000	40,000	0,21	1R40X45X40	55	NTN					
	45,000	43,800	0,24	GK40X45X43.8	40	NTN					
	45,000	53,800	0,42	1R40X45X53.8	55	NTN					
	45,000	59,000	0,31	1R40X45X59	55	NTN					
	45,000	65,000	0,17	1R40X45X65	55	NTN					
	46,000	14,300	0,07	KMJ40X46X14.3	40	NTN					
	46,000	16,600	0,04	K40X46X16.6	40	NTN					
	46,000	30,000	0,10	1R40X46X30	55	NTN					
	46,000	33,300	0,06	K40X46X33.3ZW	40	NTN					
	46,000	33,800	0,19	KV40X46X33.8	40	NTN					
	47,000	12,000	0,09	HK4012	47	NTN					
	47,000	16,000	0,12	HK4016	47	NTN					
	47,000	16,000	0,04	HK4016D	47	NTN					
	47,000	16,000	0,04	HK4016LL	47	NTN					
	47,000	17,800	0,09	K40X47X18	40	NTN					

										Brands	
d	D	B	Kg	Reference							
40,000	47,000	18,000	0,13	HK4018L	47	NTN					
	47,000	19,800	0,15	K40X47X20	40	NTN					
	47,000	20,000	0,19	BK4020	48	NTN					
	47,000	20,000	0,15	HK4020	47	NTN					
	47,000	20,000	0,05	HK4020LL	47	NTN					
	47,000	20,000	0,10	HK4020LLD	47	NTN					
	47,000	28,800	0,17	KJ40X47X28.8	40	NTN					
	47,000	31,000	0,25	NK40X47X31	41	NTN					
	48,000	18,800	0,05	KMJ40X48X18.8	40	NTN					
	48,000	19,800	0,17	K40X48X20	40	NTN					
	48,000	22,000	0,28	1R40X48X22	55	NTN					
	48,000	23,000	0,29	1R40X48X23	55	NTN					
	48,000	24,800	0,07	K40X48X25	40	NTN					
	48,000	24,800	0,20	KV40X48X25	40	NTN					
	48,000	24,800	0,06	PK40X48X24.8	40	NTN					
	48,000	30,000	0,38	1R40X48X30	55	NTN					
	48,000	37,000	0,48	1R40X48X37	55	NTN					
	48,000	40,000	0,51	1R40X48X40	55	NTN					
	50,000	15,000	0,16	HMK4015	47	NTN					
	50,000	17,000	0,15	RNA0-40X50X17	41	NTN					
	50,000	18,000	0,06	HMK4018L	47	NTN					
	50,000	20,000	0,32	1R40X50X20	55	NTN					
	50,000	20,000	0,24	NK40/20R	41	NTN					
	50,000	22,000	0,23	1R40X50X22	55	NTN					
	50,000	22,800	0,11	H40X50X22.8	40	NTN					
	50,000	25,000	0,14	1R40X50X25	55	NTN					
	50,000	28,000	0,10	HMK4028L	47	NTN					
	50,000	30,000	0,11	HMK4030	47	NTN					
	50,000	30,000	0,24	NK40/30R	41	NTN					
	50,000	31,000	0,30	HMK4031LL	47	NTN					
	50,000	34,000	0,46	RNA0-40X50X34ZW	41	NTN					
	50,000	40,000	0,43	HMK4040ZWD	47	NTN					
	52,000	12,000	0,14	NK40X52X12NR	41	NTN					
	52,000	17,800	0,23	PK40X52X17.8	40	NTN					
	52,000	20,000	0,19	RNA49/32R	41	NTN					
	52,000	27,000	0,37	RNA59/32	41	NTN					
	52,000	32,000	0,62	NKXR40	50	NTN					
	52,000	32,000	0,65	NKXR40Z	50	NTN					
	52,000	36,000	0,40	RNA69/32	41	NTN					
	52,000	36,000	0,50	RNA69/32R	41	NTN					
	52,000	60,000	0,54	KH4060	60	NTN					
	52,000	60,000	0,36	KH4060LL	60	NTN					
	54,000	3,000	0,05	ARXJ40X54X3	59	NTN					
	55,000	20,000	0,27	NK45/20R+1R40X45X20	42	NTN					
	55,000	20,000	0,45	RNA0-40X55X20	41	NTN					
	55,000	22,000	0,47	NKS40	41	NTN					
	55,000	27,500	0,15	PK40X55X27.5	40	NTN					
55,000	30,000	0,62	NK45/30R+1R40X45X30	42	NTN						
55,000	30,000	0,50	PK40X55X30	40	NTN						
55,000	40,000	0,58	RNA0-40X55X40ZW	41	NTN						
56,000	20,800	0,25	PK40XPK56X20.8	40	NTN						
56,000	24,800	0,15	K40X56X24.8	40	NTN						
56,000	27,500	0,47	PK40XPK56X27.5	40	NTN						
57,000	31,500	0,61	PK40X57X31.5	40	NTN						
57,700	2,000	0,03	AKJ40X57.7X2	57	NTN						
59,000	3,000	0,05	AKJ40X59X3	57	NTN						
59,000	30,000	0,26	NK10X59X30.5	41	NTN						
59,900	6,500	0,14	ARX40X59.9X6.5	59	NTN						
60,000	1,000	0,04	AS1108	58	NTN						
60,000	3,000	0,05	AXK1108	57	NTN						
60,000	3,500	0,12	WS81108	58	NTN						
60,000	4,000	0,03	ARXJ40X60X4	59	NTN						



								Brands	
d	D	B	Kg	Reference					
40,000	60,000	6,000	0,04	K81108	57	NTN			
	60,000	13,000	0,32	81108	56	NTN			
	60,000	29,800	0,23	PK40X60X29.8	40	NTN			
	60,000	31,800	0,73	PK40X60X31.8	40	NTN			
	60,000	32,000	0,67	NKX40	49	NTN			
	60,000	32,000	0,68	NKX40Z	49	NTN			
	60,000	48,000	0,77	AXN3570	57	NTN			
	60,000	80,000	1,86	KD406080LL	61	NTN			
	62,000	4,000	0,07	ARXJ40X62X4	59	NTN			
	62,000	22,000	0,70	NA4908R	42	NTN			
	62,000	23,000	0,80	NA4908LL	42	NTN			
	62,000	30,000	1,02	NA5908	42	NTN			
	62,000	30,000	1,04	NK1A5908A	53	NTN			
	62,000	40,000	0,46	NA0-40X62X40ZW	42	NTN			
	62,000	40,000	1,27	NA6908R	42	NTN			
	68,000	5,000	0,26	WS81208	58	NTN			
	68,000	9,000	0,20	K81208	57	NTN			
	68,000	17,500	0,22	ARX40X68X17.5	59	NTN			
	68,000	19,000	0,76	81208	56	NTN			
	68,000	31,000	0,93	ARX40X68X31	59	NTN			
	68,000	66,000	4,62	ARN3080	54	NTN			
	70,000	1,000	0,06	AS40X70X1	58	NTN			
	72,000	20,000	0,92	ARX40X72X20	59	NTN			
	75,000	54,000	1,02	ARN4075	54	NTN			
	78,000	7,000	0,20	K89308	57	NTN			
	78,000	7,500	0,60	WS89308	58	NTN			
	78,000	22,000	1,56	89308	56	NTN			
	80,000	23,000	1,86	NA2208LL	43	NTN			
	80,000	32,000	2,56	NATR40	45	NTN			
	80,000	32,000	2,50	NATR40LL	45-A	NTN			
	80,000	32,000	1,70	NATR40X	45	NTN			
	80,000	32,000	0,85	NATR40X80X32	45	NTN			
	80,000	32,000	2,50	NATR40XLL	45-A	NTN			
	80,000	32,000	1,73	NATV40	46	NTN			
	80,000	32,000	2,53	NATV40LL	46	NTN			
	80,000	32,000	0,86	NATV40X	46	NTN			
	80,000	32,000	2,54	NATV40XLL	46	NTN			
	80,000	32,000	0,82	NUTR208	52	NTN			
	80,000	32,000	2,45	NUTR208X	52	NTN			
	90,000	8,250	0,33	WS87408	58	NTN			
	90,000	23,000	0,76	87408	56	NTN			
	90,000	32,000	3,37	NUTR308	52	NTN			
	90,000	32,000	3,39	NUTR308X	52	NTN			
	110,000	23,000	1,43	ARX40X110X23	59	NTN			
	127,000	177,000	11,91	ARX40X127X177	59	NTN			
132,000	19,000	2,01	ARX40X132X19	59	NTN				
134,000	34,000	1,59	ARX40X134X34	59	NTN				
135,000	23,000	2,19	ARX40X135X23	59	NTN				
140,000	277,000	30,01	ARX40X140X277	59	NTN				
40,500	45,500	22,300	0,07	KV40.5X45.5X22.3	40	NTN			
	54,000	3,000	0,05	XS40.5X54X3	58	NTN			
40,600	61,000	5,300	0,09	ARXJ40.6X61X5.3	59	NTN			
40,700	58,000	4,700	0,02	ARXJ40.7X58X4.2	59	NTN			
41,000	46,000	21,800	0,06	GK41X46X21.8	40	NTN			
	46,000	21,800	0,06	K41X46X21.8	40	NTN			
	46,000	22,300	0,13	K41X46X22.3	40	NTN			
	46,000	23,300	0,10	KJ41X46X23.3	40	NTN			
	46,000	25,800	0,05	K41X46X25.8	40	NTN			

								Brands		
d	D	B	Kg	Reference						
41,000	46,000	28,600	0,08	KJ41X46X28.6	40	NTN				
	46,000	30,600	0,05	K41X46X30.6	40	NTN				
	47,000	12,000	0,03	HKS41X47X12	47	NTN				
	47,000	29,800	0,13	KJ41X46X29.8	40	NTN				
	57,500	2,000	0,01	AKJ41X57.5X2	57	NTN				
	57,500	2,800	0,02	ARXJ41X57.5X2.8	59	NTN				
41,275	50,800	25,650	0,13	M1-163216	55	NTN				
	50,800	32,000	0,17	M1-163220	55	NTN				
	50,800	38,350	0,41	1R41.2X50.8X38.3	55	NTN				
	55,562	25,400	0,30	MR263516	41	NTN				
	55,562	31,750	0,39	MR263520	41	NTN				
	57,275	29,800	0,53	PK41.2X57.2X29.8	40	NTN				
41,500	68,000	9,000	0,19	AKJ41.5X68X9	57	NTN				
	72,000	80,000	3,03	NUKR72	51	NTN				
42,000	47,000	16,800	0,03	K42X47X17	40	NTN				
	47,000	20,000	0,16	1R42X47X20	55	NTN				
	47,000	21,800	0,02	GK42X47X21.8	40	NTN				
	47,000	21,800	0,10	KJ42X47X21.8	40	NTN				
	47,000	23,300	0,12	KV42X47X23.3	40	NTN				
	47,000	23,800	0,12	K42X47X23.8	40	NTN				
	47,000	23,800	0,11	KJ42X47X23.8	40	NTN				
	47,000	26,800	0,05	K42X47X27	40	NTN				
	47,000	27,000	0,09	KV42X47X27	40	NTN				
	47,000	27,300	0,04	KJ42X47X27.3	40	NTN				
	47,000	28,300	0,04	PK42X47X28.3	40	NTN				
	47,000	29,800	0,11	K42X47X29.8	40	NTN				
	47,000	29,800	0,05	KJ42X47X29.8	40	NTN				
	47,000	30,000	0,24	1R42X47X30	55	NTN				
	47,000	30,300	0,14	KJ42X47X30.3	40	NTN				
	47,000	30,800	0,14	GK42X47X30.8	40	NTN				
	47,000	35,300	0,16	KJ42X47X35.3	40	NTN				
	47,000	35,300	0,05	KV42X47X35.3ZW	40	NTN				
	48,000	14,300	0,10	K42X48X14.3	40	NTN				
	48,000	16,600	0,11	K42X48X16.6	40	NTN				
	49,000	10,000	0,03	HKS42X49X10	47	NTN				
	50,000	19,800	0,18	K42X50X20	40	NTN				
	50,000	39,600	0,32	KV42X50X39.6ZW	40	NTN				
	52,000	20,000	0,24	NK42/20R	41	NTN				
52,000	30,000	0,12	NK42/30R	41	NTN					
55,000	20,000	0,30	RNA4907L	41	NTN					
55,000	20,000	0,37	RNA4907LL	41	NTN					
55,000	20,000	0,21	RNA4907R	41	NTN					
55,000	27,000	0,30	RNA5907	41	NTN					
55,000	36,000	0,37	NK42X55X36	41	NTN					
55,000	36,000	0,23	RNA6907	41	NTN					
55,000	36,000	0,39	RNA6907R	41	NTN					
57,000	20,000	0,43	NK47/20R+1R42X47X20	42	NTN					
57,000	30,000	0,64	NK47/30R+1R42X47X30	42	NTN					
57,400	35,800	0,42	PK42X57.4X35.8	40	NTN					
58,000	2,000	0,03	AKJ42X58X2	57	NTN					
59,000	5,800	0,11	ARXJ42X59X5.8	59	NTN					
60,000	3,500	0,11	GS81108	58	NTN					
60,000	3,000	0,04	AKJ42X67X3	57	NTN					
68,000	5,000	0,25	GS81208	58	NTN					
72,000	22,700	0,87	RNA2207LL	41	NTN					
78,000	7,500	0,58	GS89308	58	NTN					
120,000	140,000	15,51	NUKR120	51	NTN					
120,000	140,000	15,51	NUKR120X	51	NTN					
120,000	140,000	5,17	NUKR120	51	NTN					

d	D	B	Kg	Reference					Brands		
42,395	51,948	21,500	0,23	PK42.3X51.9X21.5	40	NTN					
43,000	48,000	16,800	0,03	K43X48X17	40	NTN					
	48,000	18,300	0,07	K43X48X18.3	40	NTN					
	48,000	22,300	0,04	KV43X48X22.3	40	NTN					
	48,000	23,300	0,07	K43X48X23.3	40	NTN					
	48,000	24,000	0,08	K43X48X24	40	NTN					
	48,000	24,500	0,20	1R43X48X24.5	55	NTN					
	48,000	25,800	0,08	KJ43X48X25.8	40	NTN					
	48,000	29,800	0,16	K43X48X29.8	40	NTN					
	48,000	29,800	0,14	KJ43X48X29.8	40	NTN					
	48,000	32,800	0,12	K43X48X32.8	40	NTN					
	48,000	35,700	0,12	K43X48X35.7	40	NTN					
	48,000	37,800	0,14	K43X48X37.8ZW	40	NTN					
	48,000	37,800	0,17	KV43X48X37.8ZW	40	NTN					
	49,000	23,800	0,08	GK43X49X23.8	40	NTN					
	49,000	27,800	0,17	GK43X49X27.8	40	NTN					
	49,000	29,300	0,06	PK43X49X29.3	40	NTN					
	49,000	35,700	0,17	K44X49X35.7	40	NTN					
	50,000	17,800	0,15	K43X50X18	40	NTN					
	50,000	51,300	0,11	KV43X50X51.3ZW	40	NTN					
	52,000	32,000	0,16	1R43X52X32	55	NTN					
	53,000	20,000	0,25	NK43/20R	41	NTN					
	53,000	30,000	0,39	NK43/30R	41	NTN					
	54,600	3,000	0,04	XS43X54.6X3	58	NTN					
	58,000	22,000	0,52	NKS43	41	NTN					
	63,000	32,800	0,78	PK43X63X32.8	40	NTN					
	159,000	269,000	37,93	ARX43X159X269	59	NTN					
43,500	58,000	5,000	0,06	ARX43.5X58X5	59	NTN					
44,000	49,000	23,800	0,04	KJ44X49X23.8	40	NTN					
	50,000	23,800	0,16	KBK44X50X23.8	40	NTN					
	50,000	27,800	0,16	KJ44X50X27.8	40	NTN					
	50,000	30,800	0,20	KV44X50X30.8	40	NTN					
	50,000	36,300	0,22	KV44X50X36.3	40	NTN					
	54,000	25,800	0,06	K44X54X25.8	40	NTN					
	57,200	2,000	0,01	AKJ44X57.5X2	57	NTN					
	57,660	2,630	0,03	ARXJ44X57.6X2.6	59	NTN					
44,400	57,100	26,850	0,13	PK44.4X57.1X26.8	40	NTN					
44,450	53,975	25,400	0,26	PCJ283416	40	NTN					
	53,975	31,750	0,22	PCJ283420	40	NTN					
	53,975	31,750	0,34	PK44.4XPK53.9X31.7	40	NTN					
	53,975	38,100	0,26	PCJ283424	40	NTN					
	53,975	38,100	0,41	PK44.4XPK53.9X38.1	40	NTN					
	53,975	44,450	0,19	PK44.4XPK53.9X44.4	40	NTN					
	57,150	44,700	0,35	M1-183628	55	NTN					
	58,450	49,750	0,64	PK44.4X58.4X49.7	40	NTN					
	58,738	25,400	0,48	MR283716	41	NTN					
	58,738	31,750	0,41	MR283720	41	NTN					
	60,450	39,750	0,77	PK44.4X60.4X39.7	40	NTN					
	60,450	44,750	0,87	PK44.4X60.4X44.7	40	NTN					
	127,000	73,025	12,16	NACV80XLL	46	NTN					
44,500	48,500	21,300	0,09	KV44.5X48.5X21.3	40	NTN					
	48,500	25,800	0,10	KV44.5X48.5X25.8ZW	40	NTN					
	60,000	2,000	0,03	AKJ44.5X60X2	57	NTN					
	64,500	34,000	0,56	PK44.5X64.5X34	40	NTN					
45,000	49,000	18,800	0,05	K45X49X19	40	NTN					

d	D	B	Kg	Reference					Brands		
45,000	50,000	16,800	0,10	K45X50X17	40	NTN					
	50,000	16,800	0,08	KJ45X50X17	40	NTN					
	50,000	17,500	0,10	1R45X50X17.5	55	NTN					
	50,000	20,000	0,11	1R45X50X20	55	NTN					
	50,000	22,300	0,07	K45X50X22.3	40	NTN					
	50,000	24,800	0,05	K45X50X24.8	40	NTN					
	50,000	25,000	0,21	1R45X50X25	55	NTN					
	50,000	25,500	0,22	1R45X50X25.5	55	NTN					
	50,000	25,800	0,02	K45X50X25.8	40	NTN					
	50,000	25,800	0,14	KV45X50X25.8	40	NTN					
	50,000	26,800	0,08	GK45X50X27S	40	NTN					
	50,000	26,800	0,15	K45X50X27	40	NTN					
	50,000	29,600	0,14	KJ45X50X29.6	40	NTN					
	50,000	32,000	0,09	1R45X50X32	55	NTN					
	50,000	35,000	0,30	1R45X50X35	55	NTN					
	50,000	40,000	0,35	1R45X50X40	55	NTN					
	51,000	24,300	0,16	KV45X51X24.3	40	NTN					
	51,000	26,800	0,04	K45X51X26.8	40	NTN					
	51,000	26,800	0,17	KV45X51X26.8	40	NTN					
	52,000	12,000	0,10	HKS45X52X12	47	NTN					
	52,000	16,000	0,05	HK4516	47	NTN					
	52,000	17,800	0,15	K45X52X18	40	NTN					
	52,000	18,000	0,05	HK4518L	47	NTN					
	52,000	20,000	0,17	HK4520	47	NTN					
	52,000	20,000	0,11	HK4520D	47	NTN					
	52,000	20,000	0,16	HK4520LL	47	NTN					
	52,000	20,800	0,17	K45X52X21	40	NTN					
	52,000	22,000	0,27	1R45X52X22	55	NTN					
	52,000	23,000	0,19	1R45X52X23	55	NTN					
	52,000	30,000	0,24	1R45X52X30	55	NTN					
	52,000	33,000	0,14	1R45X52X33	55	NTN					
	52,000	35,800	0,05	GK45X52X35.8	40	NTN					
	52,000	40,000	0,49	1R45X52X40	55	NTN					
	53,000	19,800	0,13	K45X53X20	40	NTN					
	53,000	24,800	0,16	K45X53X25	40	NTN					
	53,000	25,800	0,25	PK45XPK53X25.8	40	NTN					
	53,000	27,800	0,24	PK45XPK53X27.8	40	NTN					
	53,000	28,000	0,21	KJ45X53X28	40	NTN					
	53,000	31,800	0,09	PK45XPK53X31.8	40	NTN					
	54,500	12,000	0,06	NK45X54.5X12	41	NTN					
	55,000	17,000	0,17	RNA0-45X55X17	41	NTN					
	55,000	20,000	0,23	1R45X55X20	55	NTN					
	55,000	20,000	0,23	HMK4520	47	NTN					
	55,000	20,000	0,26	NK45/20R	41	NTN					
	55,000	22,000	0,39	1R45X55X22	55	NTN					
	55,000	25,000	0,29	HMK4525	47	NTN					
	55,000	26,000	0,04	HMK4526LL	47	NTN					
	55,000	30,000	0,25	HMK4530	47	NTN					
	55,000	30,000	0,39	NK45/30R	41	NTN					
	55,000	40,000	0,73	1R45X55X40	55	NTN					
	57,000	37,800	0,17	PK45X57X37.8	40	NTN					
	58,000	20,000	0,13	NK45X58X20	41	NTN					
	58,000	21,800	0,22	PK45X58X21.8	40	NTN					
	58,000	32,000	0,74	NKXR45	50	NTN					
	58,000	32,000	0,80	NKXR45Z	50	NTN					
	60,000	12,000	0,30	NK45X60X12NR	41	NTN					
	60,000	24,800	0,16	K45X60X24.8	40	NTN					
	60,000	30,000	0,66	NK45X60X30	41	NTN					
	60,000	39,800	0,49	K45X60X39.8	40	NTN					
	62,000	20,000									

								Brands	
d	D	B	Kg	Reference					
45,000	62,000	40,000	0,75	RNA0-45X62X40ZW	41	NTN			
	63,000	51,800	1,11	K45X63X51.8	40	NTN			
	64,000	1,800	0,05	AS45X64X1.8	58	NTN			
	64,000	80,000	0,70	NK45X64X40D2	41	NTN			
	65,000	1,000	0,04	AS1109	58	NTN			
	65,000	3,000	0,05	AXK1109	57	NTN			
	65,000	4,000	0,05	AKJ45X65X4	57	NTN			
	65,000	4,000	0,10	WS81109	58	NTN			
	65,000	6,000	0,06	K81109	57	NTN			
	65,000	14,000	0,39	81109	56	NTN			
	65,000	20,000	0,29	NA0-45X65X20	42	NTN			
	65,000	32,000	0,79	NKX45	49	NTN			
	65,000	32,000	0,27	NKX45Z	49	NTN			
	65,000	54,800	1,04	PK45X65X54.8	40	NTN			
	68,000	22,000	0,82	NA4909R	42	NTN			
	68,000	23,000	0,94	NA4909LL	42	NTN			
	68,000	30,000	1,16	NA5909	42	NTN			
	68,000	30,000	1,32	NK1A5909A	53	NTN			
	68,000	40,000	1,52	NA6909R	42	NTN			
	73,000	5,500	0,32	WS81209	58	NTN			
	73,000	9,000	0,23	K81209	57	NTN			
	73,000	20,000	0,31	81209	56	NTN			
	73,000	66,000	3,34	ARN3585	54	NTN			
	75,000	22,000	1,32	NK15X75X22	41	NTN			
	80,000	60,000	1,23	ARN4580	54	NTN			
	85,000	7,500	0,36	K89309	57	NTN			
	85,000	8,250	0,77	WS89309	58	NTN			
	85,000	24,000	2,01	89309	56	NTN			
	85,000	32,000	0,92	NATR45	45	NTN			
	85,000	32,000	1,81	NATR45LL	45-A	NTN			
	85,000	32,000	0,91	NATR45XLL	45-A	NTN			
	85,000	32,000	2,65	NUTR209	52	NTN			
	85,000	32,000	2,67	NUTR209X	52	NTN			
	100,000	32,000	4,21	NUTR309	52	NTN			
	100,000	32,000	4,18	NUTR309X	52	NTN			
	105,000	35,000	1,90	ARX45X105X35	59	NTN			
	105,000	82,000	3,16	ARN45105	54	NTN			
	115,000	44,000	4,06	ARX45X115X44	59	NTN			
	130,000	40,000	10,14	NATR45X130X40	45	NTN			
	180,000	365,000	66,72	ARX45X180X365	59	NTN			
45,400	50,000	30,000	0,34	1R45.4X55X30	55	NTN			
	64,000	4,800	0,09	ARXJ45.4X64X4.8	59	NTN			
45,550	78,000	33,000	0,63	NK45.5X78X33	41	NTN			
45,700	78,000	47,150	3,48	1R45.7X78X47.1	55	NTN			
	90,000	50,750	5,40	1R45.7X90X50.7	55	NTN			
46,000	50,000	17,800	0,03	K46X50X17.8	40	NTN			
	52,000	14,800	0,06	KMJ46X52X14.8	40	NTN			
	80,000	36,500	0,74	NK16X80X36.5	41	NTN			
46,500	63,300	9,000	0,27	NK46.5X63.3X9	41	NTN			
47,000	52,000	15,300	0,03	KV47X52X15.3	40	NTN			
	52,000	16,800	0,07	K47X52X17	40	NTN			
	52,000	22,800	0,13	KV47X52X22.8	40	NTN			
	52,000	23,800	0,13	K47X52X23.8	40	NTN			
	52,000	24,800	0,08	GK47X52X24.8	40	NTN			
	52,000	26,300	0,07	GK47X52X26.3	40	NTN			
	52,000	26,300	0,14	K47X52X26.3	40	NTN			

								Brands		
d	D	B	Kg	Reference						
47,000	52,000	26,800	0,10	K47X52X27	40	NTN				
	52,000	29,800	0,12	K47X52X29.8	40	NTN				
	52,000	32,800	0,19	KV47X52X32.8ZW	40	NTN				
	53,000	32,000	0,08	K47X53X32	40	NTN				
	54,000	51,300	0,25	GK47X54X51.3XZW	40	NTN				
	54,000	63,300	0,20	GK47X54X63.3XZW	40	NTN				
	57,000	20,000	0,27	NK47/20R	41	NTN				
	57,000	28,760	0,28	NK47X57X28.7	41	NTN				
	57,000	30,000	0,40	NK47/30R	41	NTN				
	62,000	30,000	0,38	PK46X62X30	40	NTN				
	65,000	4,000	0,14	GS81109	58	NTN				
	65,000	24,800	0,53	PK47X65X24.8	40	NTN				
	65,000	27,400	0,64	PK47X65X27.4	40	NTN				
	73,000	5,500	0,10	GS81209	58	NTN				
	85,000	8,250	0,74	GS89309	58	NTN				
	100,000	4,000	0,18	XS47X100X4	58	NTN				
	47,200	66,250	26,850	0,41	PK47.2X66.2X26.8	40	NTN			
	47,500	80,000	100,000	4,62	NUKR80X	51	NTN			
		90,000	100,000	5,88	NUKR90	51	NTN			
90,000		100,000	5,88	NUKR90X	51	NTN				
47,625	61,912	31,750	0,22	MR303920	41	NTN				
48,000	53,000	20,800	0,11	KJ48X53X20.8	40	NTN				
	53,000	22,300	0,13	KV48X53X22.3	40	NTN				
	53,000	25,800	0,06	K48X53X25.8	40	NTN				
	53,000	29,800	0,19	K48X53X29.8	40	NTN				
	53,000	29,800	0,15	KJ48X53X29.8	40	NTN				
	53,000	36,800	0,08	K48X53X36.8ZW	40	NTN				
	53,000	36,800	0,19	KV48X53X36.8ZW	40	NTN				
	54,000	16,300	0,10	K48X54X16.3	40	NTN				
	54,000	18,800	0,14	K48X54X19	40	NTN				
	54,000	23,300	0,17	KV48X54X23.3	40	NTN				
	54,000	23,800	0,10	KJ48X54X23.8	40	NTN				
	54,000	26,300	0,06	KV48X54X26.3	40	NTN				
	54,000	30,800	0,19	KJ48X54X30.8	40	NTN				
	54,000	39,800	0,16	GK48X54X39.8	40	NTN				
	55,000	24,300	0,21	KV48X55X24.3	40	NTN				
	55,000	27,000	0,27	NK48X55X27	41	NTN				
	58,000	47,800	0,63	K48X58X47.8	40	NTN				
58,000	49,300	0,22	K48X58X49.3	40	NTN					
60,000	62,800	0,90	K48X60X62.8ZW	40	NTN					
62,000	22,000	0,51	RNA4908LL	41	NTN					
62,000	22,000	0,42	RNA4908R	41	NTN					
62,000	30,000	0,64	RNA5908	41	NTN					
62,000	40,000	0,76	RNA6908R	41	NTN					
79,000	5,700	0,14	ARXJ48X79X5.7	59	NTN					
80,000	22,700	1,05	RNA2208LL	41	NTN					
140,000	160,000	23,94	NUKR140	51	NTN					
140,000	160,000	23,94	NUKR140X	51	NTN					
140,000	160,000	7,98	NUKRU140X	51	NTN					
48,200	72,000	4,000	0,14	XS48.2X72X4	58	NTN				
48,500	65,000	4,000	0,07	ARXJ48.5X65X4	59	NTN				
	66,700	3,600	0,09	ARXJ48.5X66.7X3.6	59	NTN				
49,000	54,000	32,800	0,18	KV49X54X32.8ZW	40	NTN				
	90,000	8,700	0,44	ARX49X90X8.7	59	NTN				

								Brands	
d	D	B	Kg	Reference					
50,000	55,000	13,300	0,03	K50X55X13.5	40	NTN			
	55,000	19,800	0,13	K50X55X20	40	NTN			
	55,000	19,800	0,12	KV50X55X20	40	NTN			
	55,000	20,000	0,19	1R50X55X20	55	NTN			
	55,000	25,000	0,23	1R50X55X25	55	NTN			
	55,000	26,800	0,17	K50X55X27	40	NTN			
	55,000	29,800	0,19	K50X55X30	40	NTN			
	55,000	35,000	0,33	1R50X55X35	55	NTN			
	55,000	40,000	0,26	1R50X55X40	55	NTN			
	56,000	19,800	0,05	K50X56X19.8	40	NTN			
	57,000	17,800	0,17	K50X57X18	40	NTN			
	58,000	12,000	0,09	HK50X58X12	47	NTN			
	58,000	15,000	0,11	HK50X58X15	47	NTN			
	58,000	19,800	0,21	K50X58X20	40	NTN			
	58,000	20,000	0,21	HK5020	47	NTN			
	58,000	22,000	0,34	1R50X58X22	55	NTN			
	58,000	22,000	0,08	HK5022L	47	NTN			
	58,000	23,000	0,24	1R50X58X23	55	NTN			
	58,000	24,000	0,17	HK5024LL	47	NTN			
	58,000	24,000	0,27	HK5024LLD	47	NTN			
	58,000	24,800	0,26	K50X58X25	40	NTN			
	58,000	24,800	0,08	KV50X58X25	40	NTN			
	58,000	25,000	0,27	HK5025	47	NTN			
	58,000	25,000	0,18	HK5025D	47	NTN			
	58,000	30,000	0,31	1R50X58X30	55	NTN			
	58,000	40,000	0,63	1R50X58X40	55	NTN			
	58,000	57,800	0,56	KV50X58X57.8ZW	40	NTN			
	58,500	45,200	0,78	1R50X58.5X45.2	55	NTN			
	58,600	33,100	0,19	1R50X58.6X33.1	55	NTN			
	60,000	20,000	0,39	1R50X60X20	55	NTN			
	60,000	25,000	0,49	1R50X60X25	55	NTN			
	60,000	28,000	0,55	1R50X60X28	55	NTN			
	60,000	40,000	0,52	1R50X60X40	55	NTN			
	60,000	41,800	0,57	PK50X65X41.8	40	NTN			
	62,000	25,000	0,15	NK50/25R	41	NTN			
	62,000	35,000	0,62	NK50/35R	41	NTN			
	62,000	35,000	0,31	NKX50Z	49	NTN			
	62,000	35,000	0,24	NKXR50	50	NTN			
	62,000	35,000	0,90	NKXR50Z	50	NTN			
	62,000	40,000	0,27	RNA0-50X62X40ZW	41	NTN			
	62,000	70,000	0,74	KH5070	60	NTN			
	62,000	70,000	0,48	KH5070LL	60	NTN			
	65,000	22,000	0,59	NKS50	41	NTN			
	65,000	24,800	0,18	K50X65X24.8	40	NTN			
	65,000	40,000	0,35	RNA0-50X65X40ZW	41	NTN			
	68,000	20,000	0,23	NA0-50X68X20	42	NTN			
	68,000	25,000	0,78	NK55/25R+1R50X55X25	42	NTN			
	68,000	35,000	1,10	NK55/35R+1R50X55X35	42	NTN			
	68,600	3,600	0,10	ARXJ50X68.6X3.6	59	NTN			
	70,000	1,000	0,04	AS1110	58	NTN			
70,000	3,000	0,06	AXK1110	57	NTN				
70,000	4,000	0,17	WS81110	58	NTN				
70,000	6,000	0,07	K81110	57	NTN				
70,000	9,000	0,11	ARX50X70X9	59	NTN				
70,000	14,000	0,42	81110	56	NTN				
70,000	35,000	0,91	NKX50	49	NTN				
71,000	44,800	1,37	PK50X71X44.8	40	NTN				
72,000	22,000	0,96	NA4910LL	42	NTN				
72,000	22,000	0,84	NA4910R	42	NTN				
72,000	30,000	0,39	NA5910	42	NTN				
72,000	30,000	1,05	NK10X72X30	41	NTN				
72,000	30,000	1,26	NK1A5910A	53	NTN				

								Brands		
d	D	B	Kg	Reference						
50,000	72,000	40,000	1,54	NA6910R	42	NTN				
	72,000	100,000	0,46	KD5072100LL	61	NTN				
	72,000	200,000	2,01	KD5072100	61	NTN				
	74,000	4,000	0,08	AKJ50X74X4	57	NTN				
	78,000	6,500	0,41	WS81210	58	NTN				
	78,000	9,000	0,24	K81210	57	NTN				
	78,000	22,000	0,85	81210	56	NTN				
	78,000	75,000	6,24	ARN4090	54	NTN				
	80,000	20,000	1,29	RNAB208	43-A	NTN				
	90,000	23,000	0,68	NA2210LL	43	NTN				
	90,000	32,000	2,97	NATR50	45	NTN				
	90,000	32,000	2,92	NATR50LL	45-A	NTN				
	90,000	32,000	0,99	NATR50X	45	NTN				
	90,000	32,000	0,99	NATR50X90X32	45	NTN				
	90,000	32,000	2,92	NATR50XLL	45-A	NTN				
	90,000	32,000	1,01	NATV50	46	NTN				
	90,000	32,000	2,95	NATV50LL	46	NTN				
	90,000	32,000	3,03	NATV50X	46	NTN				
	90,000	32,000	2,96	NATV50XLL	46	NTN				
	90,000	32,000	2,85	NUTR210	52	NTN				
	90,000	32,000	2,85	NUTR210X	52	NTN				
	90,000	54,000	4,04	AXN5090	57	NTN				
	90,000	60,000	1,48	ARN5090	54	NTN				
	95,000	8,000	0,52	K89310	57	NTN				
	95,000	9,500	0,74	WS89310	58	NTN				
	95,000	27,000	2,73	89310	56	NTN				
	100,000	38,000	1,53	NATR50X100X38	45	NTN				
	110,000	32,000	5,05	NUTR310	52	NTN				
	110,000	32,000	5,06	NUTR310X	52	NTN				
	160,000	218,500	69,00	ARX50X160X218.5	59	NTN				
	160,000	325,000	45,18	ARX50X160X325	59	NTN				
	50,200	57,000	48,100	0,65	1R50.2X57X48.1	55	NTN			
	50,600	72,000	4,800	0,06	ARXJ50.6X72X4.8	59	NTN			
	50,800	60,325	25,400	0,29	PCJ323816	40	NTN			
		60,325	31,750	0,24	PCJ323820	40	NTN			
		60,325	38,100	0,43	PCJ323824	40	NTN			
		63,500	38,350	0,67	M1-124024	55	NTN			
63,500		44,700	0,79	M1-124028	55	NTN				
64,800		25,400	0,49	PK50.8X64.8X25.4	40	NTN				
64,800		27,750	0,52	PK50.8X64.8X27.7	40	NTN				
64,800		31,750	0,20	PK50.8X64.8X31.7	40	NTN				
64,800		44,500	0,53	K50.8X64.8X44.5	40	NTN				
64,800		44,500	0,92	PK50.8X64.8X44.5	40	NTN				
64,800		49,800	0,20	K50.8X64.8X49.8	40	NTN				
65,088		31,750	0,69	MR324120	41	NTN				
66,800		49,800	1,10	PK50.8X66.8X49.8	40	NTN				
70,800		48,800	1,10	K50.8X70.8X48.8	40	NTN				
70,800		48,800	0,49	PK50.8X70.8X48.8	40	NTN				
127,000		200,000	13,81	CRV80XLL	44	NTN				
51,000		57,000	22,800	0,15	KJ51X57X22.8	40	NTN			
52,000	57,000	16,800	0,03	KJ52X57X16.8	40	NTN				
	57,000	17,800	0,11	KV52X57X17.8	40	NTN				
	57,000	22,800	0,14	KV52X57X22.8	40	NTN				
	58,000	16,300	0,03	K52X58X16.3	40	NTN				
	58,000	23,300	0,06	K52X58X23.3	40	NTN				
	58,000	30,600	0,25	K52X58X30.6	40	NTN				
	59,000	46,000	0,21	1R52X59X46	55	NTN				



										Brands	
d	D	B	Kg	Reference							
52,000	60,000	46,100	0,50	1R52X60X46.1	55	NTN					
	65,000	16,800	0,10	PK52X65X16.8	40	NTN					
	68,000	22,000	0,43	RNA4909LL	41	NTN					
	68,000	22,000	0,55	RNA4909R	41	NTN					
	68,000	30,000	0,79	RNA5909	41	NTN					
	68,000	34,300	0,51	PK52X68X34.3	40	NTN					
	68,000	40,000	1,02	RNA6909R	41	NTN					
	70,000	4,000	0,15	GS81110	58	NTN					
	76,500	0,800	0,04	AS52X76.5X0.8	58	NTN					
	76,500	1,000	0,03	AS52X76.5X1	58	NTN					
	78,000	6,500	0,39	GS81210	58	NTN					
	85,000	22,700	0,55	RNA2209LL	41	NTN					
	85,000	22,700	0,58	RNA2209LXL	41	NTN					
	95,000	9,500	0,72	GS89310	58	NTN					
	150,000	170,000	19,40	NUKR150	51	NTN					
	150,000	170,000	19,40	NUKR150X	51	NTN					
	150,000	170,000	9,70	NUKRT150X	51	NTN					
52,388	61,913	25,400	0,10	PK52.3X61.9X25.4	40	NTN					
53,000	57,000	19,800	0,06	KV53X57X19.8	40	NTN					
	59,000	18,300	0,09	KJ53X59X18.3	40	NTN					
	59,000	21,300	0,16	KV53X59X21.3	40	NTN					
	73,000	39,800	0,39	PK53X73X39.8	40	NTN					
53,150	70,000	40,000	0,51	1R53.1X70X40	55	NTN					
53,500	60,000	46,000	0,41	1R53.5X60X46	55	NTN					
	78,000	47,150	2,80	1R53.5X78X47.1	55	NTN					
53,600	114,000	8,000	0,36	XS53.6X114X8	58	NTN					
54,000	59,000	22,800	0,15	KV54X59X22.8	40	NTN					
	60,000	22,000	0,18	1R54X60X22	55	NTN					
	60,000	25,800	0,19	KJ54X60X25.8	40	NTN					
	60,000	28,500	0,14	KJ54X60X28.5	40	NTN					
	77,000	6,000	0,22	ARXJ54X77X6	59	NTN					
	77,100	3,600	0,08	ARXJ54X77.1X3.6	59	NTN					
54,500	59,500	23,300	0,13	KJ54.5X59.5X23.3	40	NTN					
	60,500	24,300	0,20	KV54.5X60.5X24.3	40	NTN					
	61,500	32,800	0,30	KV54.5X61.5X32.8	40	NTN					
55,000	59,000	12,800	0,05	K55X59X12.8	40	NTN					
	60,000	16,800	0,08	K55X60X17	40	NTN					
	60,000	19,800	0,14	K55X60X20	40	NTN					
	60,000	20,800	0,10	K55X60X20.8	40	NTN					
	60,000	20,800	0,12	KJ55X60X20.8	40	NTN					
	60,000	24,300	0,16	K55X60X24.3	40	NTN					
	60,000	25,000	0,26	1R55X60X25	55	NTN					
	60,000	29,800	0,14	K55X60X30	40	NTN					
	60,000	29,800	0,20	KV55X60X30	40	NTN					
	60,000	31,300	0,15	K55X60X31.3	40	NTN					
	60,000	31,300	0,19	KJ55X60X31.3	40	NTN					
	60,000	34,800	0,20	KJ55X60X34.8	40	NTN					
	60,000	35,000	0,36	1R55X60X35	55	NTN					
	60,000	36,800	0,26	K55X60X36.8	40	NTN					
	60,000	38,000	0,13	1R55X60X38	55	NTN					
	61,000	16,800	0,09	K55X61X16.8	40	NTN					
	61,000	19,000	0,12	K55X61X19	40	NTN					
	61,000	29,800	0,15	K55X61X30	40	NTN					
	61,000	29,800	0,07	KJ55X61X30	40	NTN					

										Brands	
d	D	B	Kg	Reference							
55,000	61,000	33,000	0,19	K55X61X33	40	NTN					
	61,000	33,000	0,26	KJ55X61X33	40	NTN					
	61,000	39,800	0,31	KJ55X61X39.8	40	NTN					
	62,000	17,800	0,18	K55X62X18	40	NTN					
	63,000	19,800	0,16	K55X63X20	40	NTN					
	63,000	24,800	0,29	K55X63X25	40	NTN					
	63,000	25,000	0,28	1R55X63X25	55	NTN					
	63,000	27,800	0,11	K55X63X27.8	40	NTN					
	63,000	31,800	0,36	K55X63X32	40	NTN					
	63,000	34,000	0,38	1R55X63X34	55	NTN					
	63,000	45,000	0,77	1R55X63X45	55	NTN					
	65,000	28,000	0,62	1R55X65X28	55	NTN					
	65,000	30,000	0,65	1R55X65X30	55	NTN					
	65,000	40,600	0,38	K55X65X40.6	40	NTN					
	65,000	60,000	0,87	1R55X65X60	55	NTN					
	67,000	20,000	0,24	NK55X67X20	41	NTN					
	67,000	27,300	0,15	PK55X67X27.3	40	NTN					
	68,000	20,000	0,17	RNA0-55X68X20	41	NTN					
	68,000	25,000	0,54	NK55/25R	41	NTN					
	68,000	35,000	0,76	NK55/35R	41	NTN					
	68,000	40,000	0,34	RNA0-55X68X40	41	NTN					
	69,000	24,800	0,47	PK55X69X24.8	40	NTN					
	69,000	34,800	0,68	PK55X69X34.8	40	NTN					
	72,000	22,000	0,75	NK55	41	NTN					
	72,000	25,000	0,77	NK60/25R+1R55X60X25	42	NTN					
	72,000	35,000	1,09	NK60/35R+1R55X60X35	42	NTN					
	72,000	40,000	0,45	RNA0-55X72X40Z	41	NTN					
	75,000	39,800	1,15	PK55X75X39.8	40	NTN					
	77,000	35,800	0,77	PK55X77X35.8	40	NTN					
	78,000	1,000	0,06	AS1111	58	NTN					
	78,000	3,000	0,08	AXK1111	57	NTN					
	78,000	3,000	0,10	XS55X78X3	58	NTN					
	78,000	5,000	0,27	WS81111	58	NTN					
	78,000	6,000	0,14	K81111	57	NTN					
	78,000	16,000	0,26	81111	56	NTN					
	78,000	16,000	0,71	81111J	56	NTN					
	80,000	16,000	0,88	ARX55X80X16	59	NTN					
	80,000	25,000	0,40	NA4911R	42	NTN					
	80,000	34,000	1,71	NA5911	42	NTN					
	80,000	34,000	1,53	NK15X80X34	41	NTN					
	80,000	34,000	1,18	NK1A5911A	53	NTN					
	80,000	45,000	2,20	NA6911R	42	NTN					
	80,000	52,200	3,21	1R55X80X52.2	55	NTN					
	90,000	7,000	0,63	WS81211	58	NTN					
	90,000	11,000	0,33	K81211	57	NTN					
	90,000	25,000	1,66	81211	56	NTN					
	105,000	9,000	0,47	K89311	57	NTN					
105,000	10,500	1,00	WS89311	58	NTN						
105,000	30,000	1,23	89311	56	NTN						
115,000	82,000	7,22	ARN55115	54	NTN						
120,000	29,000	1,72	87411	56	NTN						
120,000	68,000	6,33	NATR55X120X68	45	NTN						
126,000	39,500	3,05	ARX55X126X39.5	59	NTN						
178,000	40,000	6,90	ARX55X178X40	59	NTN						
178,000	48,000	8,28	ARX55X178X48	59	NTN						
178,000	50,500	13,15	ARX55X178X50.5	59	NTN						
56,000	61,000	17,800	0,10	KJ56X61X17.8	40	NTN					
	61,000	33,600	0,16	K56X61X33.6	40	NTN					
	62,000	16,000	0,05	KV56X62X16	40	NTN					
	66,000	40,800	0,44	K56X66X40.8	40	NTN					
	72,000	30,800	0,24	PK56X72X30.8	40	NTN					

												Brands	
d	D	B	Kg	Reference									
56,000	73,000	4,900	0,07	ARXJ56X73X4.9	59	NTN							
	160,000	50,000	5,62	ARX56X160X50	59	NTN							
57,000	64,000	31,100	0,32	K57X64X31.1	40	NTN							
	64,000	33,800	0,23	K57X64X33.8	40	NTN							
	64,000	41,750	0,66	1R57X64X41.7	55	NTN							
	65,000	39,800	0,44	KV57X65X39.8ZW	40	NTN							
	73,000	29,800	0,48	PK57X73X29.8	40	NTN							
	73,000	49,700	0,44	PK57X73X49.7	40	NTN							
	78,000	5,000	0,25	GS81111	58	NTN							
	90,000	7,000	0,61	GS81211	58	NTN							
	105,000	10,500	0,98	GS89311	58	NTN							
	57,150	69,850	38,350	0,76	M1-164424	55	NTN						
69,850		44,700	0,44	M1-164428	55	NTN							
76,200		38,100	1,26	MR364824	41	NTN							
76,200		44,450	1,48	MR364828	41	NTN							
152,400		85,725	9,80	NACV96XLL	46	NTN							
57,160	90,000	34,000	0,78	NK57.1X90X34	41	NTN							
57,200	81,550	3,985	0,12	ARXJ57.2X81.5X3.9	59	NTN							
57,250	69,850	38,350	0,38	1R57.2X69.8X38.3	55	NTN							
57,500	65,500	30,800	0,36	KV57.5X65.5X30.8	40	NTN							
	65,500	36,300	0,14	KV57.5X65.5X36.3	40	NTN							
57,700	72,000	80,000	0,75	NK57.7X72X40D2	41	NTN							
58,000	63,000	29,800	0,14	K58X63X29.8	40	NTN							
	63,000	31,800	0,08	K58X63X31.8	40	NTN							
	63,000	34,300	0,07	K58X63X34.3ZW	40	NTN							
	64,000	16,300	0,05	K58X64X16.3	40	NTN							
	64,000	18,800	0,06	K58X64X19	40	NTN							
	65,000	26,500	0,09	GK58X65X26.5	40	NTN							
	70,000	30,200	0,85	1R58X70X30.2	55	NTN							
	70,000	32,200	0,91	1R58X70X32.2	55	NTN							
	72,000	22,000	0,59	RNA4910LL	41	NTN							
	72,000	22,000	0,50	RNA4910R	41	NTN							
	72,000	30,000	0,70	RNA5910	41	NTN							
	72,000	40,000	0,60	RNA6910R	41	NTN							
	80,000	64,200	1,51	K58X80X64.2	40	NTN							
	80,000	64,200	2,53	PK58X80X64.2	40	NTN							
	86,700	4,780	0,15	ARXJ58X86.7X4.7	59	NTN							
	87,000	13,250	0,68	ARX58X87X13.2	59	NTN							
	90,000	22,700	0,61	RNA2210LL	41	NTN							
	90,000	22,700	1,69	RNA2210XLL	41	NTN							
58,400	88,000	5,500	0,27	ARXJ58.4X88X5.5	59	NTN							
59,332	81,998	50,550	0,65	PK59.3X81.9X50.5	40	NTN							
59,600	80,000	13,500	0,17	NK59.6X80X13.5	41	NTN							
60,000	64,000	7,450	0,02	1R60X64X7.4	55	NTN							
	65,000	19,800	0,15	K60X65X20	40	NTN							
	65,000	26,800	0,20	K60X65X26.8	40	NTN							
	65,000	29,800	0,23	K60X65X30	40	NTN							
	66,000	18,800	0,12	K60X66X19	40	NTN							
	66,000	22,800	0,21	K60X66X22.8	40	NTN							
	66,000	29,800	0,17	K60X66X30	40	NTN							

												Brands	
d	D	B	Kg	Reference									
60,000	66,000	32,800	0,21	K60X66X32.8ZW	40	NTN							
	68,000	12,000	0,05	HKS60X68X12	47	NTN							
	68,000	19,800	0,25	K60X68X20	40	NTN							
	68,000	22,800	0,29	K60X68X23	40	NTN							
	68,000	24,800	0,11	K60X68X25	40	NTN							
	68,000	25,000	0,46	1R60X68X25	55	NTN							
	68,000	26,800	0,23	K60X68X27	40	NTN							
	68,000	34,000	0,62	1R60X68X34	55	NTN							
	68,000	35,000	0,65	1R60X68X35	55	NTN							
	68,000	45,000	0,83	1R60X68X45	55	NTN							
	70,000	25,000	0,58	1R60X70X25	55	NTN							
	70,000	28,000	0,65	1R60X70X28	55	NTN							
	70,000	30,000	0,71	1R60X70X30	55	NTN							
	70,000	60,000	0,94	1R60X70X60	55	NTN							
	72,000	25,000	0,52	NK60/25R	41	NTN							
	72,000	25,000	0,40	NK60X72X25	41	NTN							
	72,000	35,000	0,73	NK60/35R	41	NTN							
	74,000	2,500	0,02	AKJ60X74X2.5	57	NTN							
	74,000	56,500	1,90	1R60X74X56.5	55	NTN							
	75,000	35,800	0,31	K60X75X35.8	40	NTN							
	75,000	49,800	0,39	K60X75X49.8	40	NTN							
	76,000	54,800	1,44	PK60X76X54.8	40	NTN							
	78,000	20,000	0,52	RNA0-60X78X20	41	NTN							
	78,000	29,800	0,88	PK60X78X29.8	40	NTN							
	78,000	40,000	1,59	RNA0-60X78X40ZW	41	NTN							
	78,500	2,500	0,03	AKJ60X78.5X2.5	57	NTN							
	80,000	2,500	0,04	XS60X80X2.5	58	NTN							
	80,000	28,000	1,25	NKS60	41	NTN							
	82,000	25,000	1,14	NK68/25R+1R60X68X25	42	NTN							
	82,000	35,000	1,61	NK68/35R+1R60X68X35	42	NTN							
	82,000	44,800	1,65	PK60X82X44.8	40	NTN							
	84,000	36,800	0,50	PK60X84X36.8	40	NTN							
	84,000	38,800	1,56	PK60X84X38.8	40	NTN							
	85,000	1,000	0,07	AS1112	58	NTN							
	85,000	3,000	0,09	AXK1112	57	NTN							
	85,000	3,000	0,16	XS60X85X3	58	NTN							
	85,000	4,200	0,09	XS60X85X4.2	58	NTN							
	85,000	4,750	0,30	WS81112	58	NTN							
	85,000	7,500	0,08	K81112	57	NTN							
	85,000	17,000	0,77	81112	56	NTN							
	85,000	17,000	0,54	81112	56	NTN							
	85,000	25,000	1,28	NA4912R	42	NTN							
85,000	34,000	1,85	NA5912	42	NTN								
85,000	34,000	1,25	NK1A5912A	53	NTN								
85,000	40,000	1,42	NKX60	49	NTN								
85,000	45,000	2,36	NA6912R	42	NTN								
85,000	100,000	1,43	KD6085100LL	61	NTN								
86,500	40,000	1,47	NKX60Z	49	NTN								
95,000	7,500	0,72	WS81212	58	NTN								
95,000	11,000	0,44	K81212	57	NTN								
95,000	26,000	1,95	81212	56	NTN								
95,000	82,000	6,52	ARN50110	54	NTN								
110,000	9,000	0,49	K89312	57	NTN								
110,000	10,500	1,59	WS89312	58	NTN								

d	D	B	Kg	Reference					
60,325	69,850	38,100	0,17	PK60.3X69.8X38.1	40	NTN			
60,700	73,000	50,300	1,01	1R60.7X73X50.3	55	NTN			
	90,000	40,300	3,27	1R60.7X90X40.3	55	NTN			
60,800	82,100	7,800	0,04	ARXJ60.8X81.9X7.8	59	NTN			
61,000	66,000	19,800	0,15	K61X66X20	40	NTN			
	66,000	21,800	0,17	K61X66X21.8	40	NTN			
	66,000	31,800	0,07	KV61X66X31.8ZW	40	NTN			
	70,000	8,000	0,06	K61X70X8	40	NTN			
61,400	85,000	6,000	0,13	ARXJ61.4X85X6	59	NTN			
61,880	85,600	4,795	0,19	ARXJ61.8X85.6X4.7	59	NTN			
	86,000	3,985	0,12	ARXJ61.8X86X3.9	59	NTN			
62,000	70,000	23,800	0,31	K62X70X23.8	40	NTN			
	73,000	2,000	0,02	AKJ62X73X2	57	NTN			
	85,000	4,750	0,28	GS81112	58	NTN			
	95,000	5,700	0,20	ARXJ62X95X5.7	59	NTN			
	95,000	7,500	0,69	GS81212	58	NTN			
	110,000	10,500	1,04	GS89312	58	NTN			
62,150	74,000	50,000	0,47	1R62.1X74X50	55	NTN			
63,000	71,000	44,200	0,35	KV63X71X44.2ZW	40	NTN			
	71,000	50,300	0,58	KV63X71X50.3ZW	40	NTN			
	77,000	35,800	0,27	PK63X77X35.8	40	NTN			
	80,000	25,000	0,78	RNA4911R	41	NTN			
	80,000	25,000	1,49	RNA6911R	41	NTN			
	80,000	34,000	1,14	RNA5911	41	NTN			
	90,000	50,300	3,81	1R63X90X50.3	55	NTN			
63,500	73,025	25,400	0,12	PCJ404616	40	NTN			
	73,025	38,100	0,36	PCJ404624	40	NTN			
	76,200	38,350	0,81	M1-104824	55	NTN			
	76,200	44,700	0,95	M1-104828	55	NTN			
	82,550	38,100	0,94	MR405224	41	NTN			
	82,550	44,450	1,59	MR405228	41	NTN			
	87,800	3,985	0,09	ARXJ63.5X87.8X3.9	59	NTN			
64,000	70,000	15,800	0,05	K64X70X16	40	NTN			
	70,000	27,100	0,25	K64X70X27.1	40	NTN			
	71,000	36,800	0,14	K64X71X36.8	40	NTN			
	71,000	47,600	0,18	K64X71X47.6ZW	40	NTN			
	72,000	27,300	0,24	K64X72X27.3	40	NTN			
	72,000	31,100	0,40	K64X72X31.3	40	NTN			
	72,000	44,600	0,53	KV64X72X44.6ZW	40	NTN			
	91,800	0,800	0,05	AS64X91.8X0.8	58	NTN			
	180,000	200,000	18,68	NUKR180	51	NTN			
	180,000	200,000	17,00	NUKRT180X	51	NTN			
64,700	95,000	41,900	3,72	1R64.7X95X41.9	55	NTN			
65,000	70,000	19,800	0,16	K65X70X20	40	NTN			
	70,000	21,300	0,17	KV65X70X21.3	40	NTN			
	70,000	27,800	0,23	K65X70X27.8	40	NTN			
	70,000	29,800	0,16	K65X70X30	40	NTN			
	70,000	49,100	0,21	GK65X70X49.1XZW	40	NTN			
	70,000	62,300	0,40	GK65X70X62.3XZW	40	NTN			
	72,000	25,000	0,43	1R65X72X25	55	NTN			

d	D	B	Kg	Reference					
65,000	72,000	34,000	0,58	1R65X72X34	55	NTN			
	72,000	45,000	0,77	1R65X72X45	55	NTN			
	73,000	22,800	0,32	K65X73X23	40	NTN			
	73,000	25,000	0,16	1R65X73X25	55	NTN			
	73,000	29,600	0,39	KV65X73X29.6	40	NTN			
	73,000	29,800	0,40	K65X73X30	40	NTN			
	73,000	35,000	0,46	1R65X73X35	55	NTN			
	75,000	28,000	0,70	1R65X75X28	55	NTN			
	75,000	60,000	0,51	1R65X75X60	55	NTN			
	78,000	25,000	0,63	NK65/25R	41	NTN			
	78,000	35,000	0,88	NK65/35R	41	NTN			
	79,300	2,800	0,07	ARXJ65X79.3X2.8	59	NTN			
	80,000	35,500	0,94	K65X80X35.5	40	NTN			
	85,000	28,000	0,71	NKS65	41	NTN			
	85,000	30,000	0,48	RNA0-65X85X30	41	NTN			
	85,000	31,700	1,12	PK65X85X31.7	40	NTN			
	85,000	43,800	1,02	PK65X85X43.8	40	NTN			
	85,000	60,000	1,90	RNA0-65X85X60ZW	41	NTN			
	89,000	39,800	1,09	PK65X89X39.8	40	NTN			
	90,000	1,000	0,07	AS1113	58	NTN			
	90,000	2,500	0,11	XS65X90X2.5	58	NTN			
	90,000	3,000	0,10	AXK1113	57	NTN			
	90,000	3,000	0,13	XS65X90X3	58	NTN			
	90,000	5,250	0,24	WS81113	58	NTN			
	90,000	7,500	0,21	K81113	57	NTN			
	90,000	18,000	0,60	81113	56	NTN			
	90,000	25,000	1,37	NA4913R	42	NTN			
90,000	25,000	1,40	NK73/25R+1R65X73X25	42	NTN				
90,000	33,800	0,92	PK65X90X33.8	40	NTN				
90,000	34,000	1,97	NA5913	42	NTN				
90,000	34,000	0,68	NK1A5913A	53	NTN				
90,000	35,000	1,98	NK73/35R+1R65X73X35	42	NTN				
90,000	45,000	0,85	NA6913R	42	NTN				
91,000	54,800	2,48	PK65X91X54.8	40	NTN				
92,000	19,500	1,21	ARX65X92X19.5	59	NTN				
100,000	8,000	0,83	WS81213	58	NTN				
100,000	11,000	0,47	K81213	57	NTN				
100,000	27,000	1,55	81213	56	NTN				
115,000	9,000	0,53	K89313	57	NTN				
115,000	10,500	1,13	WS89313	58	NTN				
115,000	30,000	2,86	89313	56	NTN				
65,300	78,000	36,300	1,22	1R65.3X78X36.3	55	NTN			
66,000	75,000	40,200	0,92	1R66X75X40.2	55	NTN			
	76,000	35,800	0,37	PK66X76X35.8	40	NTN			
	80,000	40,200	1,43	1R66X80X40.2	55	NTN			
	88,000	1,200	0,05	AS66X88X1.2	58	NTN			
	88,000	1,600	0,10	AS66X88X1.6	58	NTN			
	88,000	1,800	0,11	AS66X88X1.8	58	NTN			
	88,000	2,000	0,04	AS66X88X2	58	NTN			
	88,000	2,200	0,05	AS66X88X2.2	58	NTN			
	89,500	6,600	0,07	ARXJ66X89.5X6.6	59	NTN			
67,000	73,000	28,800	0,30	K67X73X28.8	40	NTN			
	74,000	21,800	0,09	K67X74X21.8	40	NTN			
	74,000	24,300	0,30	K67X74X24.3	40	NTN			
	83,000	13,500	0,58	1R67X83X13.5	55	NTN			
	90,000	5,250	0,22	GS81113	58	NTN			
	100,000	8,000	0,78	GS81213	58	NTN			
	115,000	10,500	0,37	GS89313	58	NTN			

d	D	B	Kg	Reference	Brands
68,000	73,000	9,800	0,04	K68X73X9.8	40 NTN
	73,000	31,400	0,25	KV68X73X31.4ZW	40 NTN
	74,000	19,800	0,21	K68X74X20	40 NTN
	74,000	34,800	0,11	K68X74X35ZW	40 NTN
	75,000	20,800	0,15	K68X75X21	40 NTN
	75,000	23,300	0,10	K68X75X23.3	40 NTN
	76,000	26,800	0,13	K68X76X26.8	40 NTN
	76,000	36,300	0,18	K68X76X36.3ZW	40 NTN
	76,000	38,800	0,19	K68X76X38.8ZW	40 NTN
	76,000	47,800	0,23	K68X76X47.8ZW	40 NTN
	82,000	25,000	0,63	NK68/25R	41 NTN
	82,000	35,000	0,96	NK68/35R	41 NTN
	85,000	25,000	0,83	RNA4912R	41 NTN
	85,000	34,000	1,20	RNA5912	41 NTN
	85,000	35,000	1,52	RNA6912R	41 NTN
	85,000	38,200	1,83	1R68X85X38.2	55 NTN
	90,000	47,000	0,99	1R68X90X47	55 NTN
	90,000	48,000	0,99	1R68X90X48	55 NTN
	100,000	15,500	1,31	ARX68X100X15.5	59 NTN
	69,000	91,250	4,600	0,05	ARXJ69X91.2X4.6
69,850	82,550	44,700	1,04	M1-145228	55 NTN
	88,900	38,100	0,98	MR445624	41 NTN
	88,900	44,450	1,73	MR445628	41 NTN
70,000	76,000	19,800	0,22	K70X76X19.8	40 NTN
	76,000	19,800	0,21	K70X76X20	40 NTN
	76,000	29,800	0,11	K70X76X30	40 NTN
	78,000	22,800	0,12	K70X78X23	40 NTN
	78,000	29,800	0,44	K70X78X30	40 NTN
	78,000	38,750	0,85	1R70X78X38.7	55 NTN
	78,000	47,100	0,68	1R70X78X47.1	55 NTN
	80,000	25,000	0,67	1R70X80X25	55 NTN
	80,000	28,000	0,25	1R70X80X28	55 NTN
	80,000	30,000	0,81	1R70X80X30	55 NTN
	80,000	35,000	0,94	1R70X80X35	55 NTN
	80,000	39,800	0,46	PK70X80X39.8	40 NTN
	80,000	40,000	1,08	1R70X80X40	55 NTN
	80,000	44,800	0,29	PK70X80X44.8	40 NTN
	80,000	54,000	1,47	1R70X80X54	55 NTN
	80,000	56,000	1,52	1R70X80X56	55 NTN
	80,000	60,000	1,08	1R70X80X60	55 NTN
	80,000	92,000	0,85	1R70X80X92	55 NTN
	82,000	40,000	1,13	NK70X82X40	41 NTN
	85,000	25,000	0,77	NK70/25R	41 NTN
	85,000	35,000	1,09	NK70/35R	41 NTN
	85,000	40,500	1,71	1R70X85X40.5	55 NTN
	90,000	28,000	1,21	NKS70R	41 NTN
	90,000	30,000	0,51	RNA0-70X90X30	41 NTN
	90,000	48,300	2,84	1R70X90X48.3	55 NTN
	90,000	50,300	2,92	1R70X90X50.3	55 NTN
	90,000	56,300	3,30	1R70X90X56.3	55 NTN
	90,000	60,000	3,05	RNA0-70X90X60ZW	41 NTN
	95,000	1,000	0,07	AS1114	58 NTN
	95,000	4,000	0,10	AXK1114	57 NTN
	95,000	5,250	0,38	WS81114	58 NTN
	95,000	7,500	0,22	K81114	57 NTN
	95,000	18,000	0,96	81114	56 NTN
	95,000	25,000	1,51	NK80/25R+1R70X80X25	42 NTN
	95,000	35,000	1,42	NK80/35R+1R70X80X35	42 NTN
	95,000	40,000	1,80	NKX70	49 NTN

d	D	B	Kg	Reference	Brands	
70,000	95,000	41,900	2,12	1R70X95X41.9	55 NTN	
	100,000	30,000	1,57	NA4914R	42 NTN	
	100,000	40,000	3,00	NA5914	42 NTN	
	100,000	40,000	2,13	NK1A5914A	53 NTN	
	100,000	54,000	3,93	NA6914R	42 NTN	
	105,000	4,000	0,15	XS70X105X4	58 NTN	
	105,000	8,000	0,87	WS81214	58 NTN	
	105,000	11,000	0,20	K81214	57 NTN	
	105,000	27,000	2,45	81214	56 NTN	
	125,000	10,000	0,67	K89314	57 NTN	
	125,000	12,000	1,55	WS89314	58 NTN	
	125,000	34,000	3,73	89314	56 NTN	
	150,000	11,000	1,33	K87414	57 NTN	
	150,000	12,500	2,63	WS87414	58 NTN	
	165,000	96,000	12,90	ARX70X165X96	59 NTN	
	70,050	95,170	3,040	0,07	XS70X95.1X3	58 NTN
	70,300	85,000	38,100	1,58	1R70.3X85X38.1	55 NTN
71,000	78,000	27,800	0,22	K71X78X27.8	40 NTN	
	78,000	53,100	0,67	1R71X78X53.1	55 NTN	
	79,000	24,200	0,36	K71X79X24.2	40 NTN	
	85,000	40,000	1,60	1R71X85X40	55 NTN	
	130,000	41,000	2,93	ARX71X130X41	59 NTN	
72,000	78,000	39,800	0,21	K72X78X39.8ZW	40 NTN	
	80,000	19,300	0,10	KV72X80X19.3	40 NTN	
	80,000	35,800	0,03	KV72X80X35.8	40 NTN	
	80,000	39,800	0,55	KV72X80X39.8ZW	40 NTN	
	90,000	25,000	0,95	RNA4913R	41 NTN	
	90,000	34,000	1,37	RNA5913	41 NTN	
	90,000	45,000	1,70	RNA6913R	41 NTN	
	90,500	14,500	0,52	1R72X90.5X14.5	55 NTN	
	95,000	5,250	0,35	GS81114	58 NTN	
	105,000	8,000	0,84	GS81214	58 NTN	
	125,000	12,000	1,51	GS89314	58 NTN	
73,000	79,000	19,800	0,07	K73X79X20	40 NTN	
	79,000	24,800	0,26	K73X79X24.8	40 NTN	
	79,000	29,800	0,21	K73X79X30	40 NTN	
	81,000	37,500	0,53	K73X81X37.5	40 NTN	
	90,000	25,000	0,91	NK73/25R	41 NTN	
	90,000	35,000	1,29	NK73/35R	41 NTN	
	150,000	12,500	2,59	GS87414	58 NTN	
73,130	100,000	4,810	0,22	ARXJ73.1X100X4.8	59 NTN	
74,000	82,000	21,800	0,34	K74X82X21.8	40 NTN	
	90,000	49,800	0,32	K74X90X49.8	40 NTN	
	90,000	49,800	1,00	PK74X90X49.8	40 NTN	
	98,000	35,800	0,58	PK74X98X35.8	40 NTN	
75,000	81,000	19,800	0,20	KM.J75X81X20	40 NTN	
	81,000	19,800	0,21	KV75X81X19.8	40 NTN	
	81,000	29,800	0,23	K75X81X30	40 NTN	
	82,000	21,000	0,30	K75X82X21	40 NTN	
	83,000	19,800	0,27	PK75X83X19.8	40 NTN	
	83,000	22,800	0,34	K75X83X23	40 NTN	
	83,000	29,800	0,31	K75X83X30	40 NTN	
	83,000	32,600	0,48	KV75X83X32.6ZW	40 NTN	
	85,000	25,000	0,71	1R75X85X25	55 NTN	



								Brands		
d	D	B	Kg	Reference						
75,000	85,000	30,000	0,86	1R75X85X30	55	NTN				
	85,000	35,000	1,01	1R75X85X35	55	NTN				
	85,000	40,000	1,15	1R75X85X40	55	NTN				
	85,000	54,000	1,58	1R75X85X54	55	NTN				
	90,000	29,800	0,56	PK75X90X29.8	40	NTN				
	90,000	41,700	0,77	PK75X90X41.7	40	NTN				
	92,000	25,000	0,93	NK75/25R	41	NTN				
	92,000	35,000	0,49	NK75/35R	41	NTN				
	95,000	30,000	0,54	RNA0-75X95X30	41	NTN				
	95,000	60,000	2,16	RNA0-75X95X60ZW	41	NTN				
	100,000	1,000	0,08	AS1115	58	NTN				
	100,000	4,000	0,16	AXK1115	57	NTN				
	100,000	5,750	0,44	WS81115	58	NTN				
	100,000	7,500	0,09	K81115	57	NTN				
	100,000	19,000	1,08	81115	56	NTN				
	105,000	25,000	1,28	NK85/25R+1R75X85X25	42	NTN				
	105,000	30,000	2,28	NA4915R	42	NTN				
	105,000	35,000	1,81	NK85/35R+1R75X85X35	42	NTN				
	105,000	40,000	2,02	NA5915	42	NTN				
	105,000	49,800	1,01	PK75X105X49.8	40	NTN				
	105,000	54,000	4,17	NA6915R	42	NTN				
	110,000	8,000	0,92	WS81215	58	NTN				
	110,000	11,000	0,35	K81215	57	NTN				
	110,000	27,000	2,35	81215	56	NTN				
	110,000	27,000	1,69	81215J	56	NTN				
	110,000	82,000	4,14	ARN65125	54	NTN				
	135,000	11,000	0,93	K89315	57	NTN				
	135,000	12,500	1,88	WS89315	58	NTN				
	135,000	36,000	6,99	89315	56	NTN				
	152,000	28,500	3,00	ARX75X152X28.5	59	NTN				
	160,000	13,000	1,59	WS87415	58	NTN				
	76,000	80,000	9,000	0,02	K76X80X9	40	NTN			
		90,000	50,400	2,15	1R76X90X50.4	55	NTN			
90,000		60,200	2,56	1R76X90X60.2	55	NTN				
76,200	85,725	31,750	0,17	PK76.2X85.7X31.7	40	NTN				
	85,725	38,100	0,41	PK76.2X85.7X38.1	40	NTN				
	88,900	51,050	1,93	M1-185632	55	NTN				
	95,250	38,100	1,61	MR486024	41	NTN				
	95,250	44,450	1,89	MR486028	41	NTN				
77,000	100,000	5,750	0,41	GS81115	58	NTN				
	110,000	8,000	0,88	GS81215	58	NTN				
	135,000	12,500	1,84	GS89315	58	NTN				
78,000	85,000	23,300	0,11	K78X85X23.3	40	NTN				
	85,000	38,200	0,52	K78X85X38.2	40	NTN				
	85,000	41,800	0,20	K78X85X41.8ZW	40	NTN				
	86,000	35,800	0,38	K78X86X35.8	40	NTN				
	86,000	47,800	0,48	KV78X86X47.8ZW	40	NTN				
	160,000	13,000	3,10	GS87415	58	NTN				
79,000	91,000	52,500	1,95	1R79X91X52.5	55	NTN				
	91,000	63,000	2,30	1R79X91X63	55	NTN				
	95,000	52,500	2,70	1R79X95X52.5	55	NTN				
79,375	95,250	51,050	1,70	M1-106032	55	NTN				
80,000	86,000	19,800	0,08	K80X86X20	40	NTN				
	86,000	19,800	0,23	KV80X86X20	40	NTN				
	86,000	29,800	0,36	K80X86X30	40	NTN				

								Brands	
d	D	B	Kg	Reference					
80,000	88,000	25,400	0,42	K80X88X25.4	40	NTN			
	88,000	25,800	0,14	K80X88X26	40	NTN			
	88,000	27,800	0,30	K80X88X27.8	40	NTN			
	88,000	29,800	0,33	K80X88X30	40	NTN			
	88,000	51,800	0,75	GK80X88X51.8XZW	40	NTN			
	88,000	96,000	0,78	1R80X88X96	55	NTN			
	90,000	25,000	0,75	1R80X90X25	55	NTN			
	90,000	30,000	0,92	1R80X90X30	55	NTN			
	90,000	35,000	1,07	1R80X90X35	55	NTN			
	90,000	40,000	1,23	1R80X90X40	55	NTN			
	90,000	50,300	0,52	1R80X90X50.3	55	NTN			
	90,000	54,000	1,66	1R80X90X54	55	NTN			
	90,000	57,800	1,18	1R80X90X57.8	55	NTN			
	90,000	60,000	1,88	1R80X90X60	55	NTN			
	95,000	25,000	0,30	NK80/25R	41	NTN			
	95,000	30,000	0,82	RNA0-80X95X30	41	NTN			
	95,000	32,000	1,00	1R80X95X32	55	NTN			
	95,000	35,000	1,19	NK80/35R	41	NTN			
	95,000	56,000	1,47	RNA0-80X95X56ZW	41	NTN			
	95,000	57,900	1,87	1R80X95X57.9	55	NTN			
	96,000	37,800	0,41	PK80X96X37.8	40	NTN			
	100,000	30,000	1,14	RNA0-80X100X30	41	NTN			
	100,000	30,000	1,52	RNA4914R	41	NTN			
	100,000	40,000	1,28	RNA5914	41	NTN			
	100,000	54,000	1,66	RNA6914R	41	NTN			
	100,000	55,800	2,23	PK80X100X55.8	40	NTN			
	100,000	60,000	2,28	RNA0-80X100X60ZW	41	NTN			
	105,000	1,000	0,08	AS1116	58	NTN			
	105,000	3,400	0,18	XS80X105X3.4	58	NTN			
	105,000	4,000	0,17	AXK1116	57	NTN			
	105,000	5,750	0,47	WS81116	58	NTN			
	105,000	7,500	0,16	K81116	57	NTN			
	105,000	19,000	1,31	81116	56	NTN			
107,950	88,900	2,44	NK80X107.9X88.9	51	NTN				
110,000	25,000	1,34	NK90/25R+1R80X90X25	42	NTN				
110,000	30,000	2,47	NA4916R	42	NTN				
110,000	35,000	2,86	NK90/35R+1R80X90X35	42	NTN				
110,000	40,000	3,36	NA5916	42	NTN				
110,000	54,000	2,97	NA6916R	42	NTN				
110,000	96,000	2,53	NK10X110X96	41	NTN				
110,000	152,000	4,71	NA0-80X110X152	42	NTN				
115,000	8,500	1,04	WS81216	58	NTN				
115,000	11,000	0,56	K81216	57	NTN				
115,000	28,000	1,72	81216	56	NTN				
115,000	82,000	8,50	ARN70130	54	NTN				
140,000	11,000	1,48	K89316	57	NTN				
140,000	12,500	2,96	WS89316	58	NTN				
140,000	36,000	4,90	89316	56	NTN				
81,000	92,000	51,000	0,59	1R81X92X51	55	NTN			
	92,000	54,100	0,60	1R81X92X54.1	55	NTN			
	92,000	67,650	1,57	1R81X92X67.6	55	NTN			
	95,000	52,100	0,77	1R81X95X52.1	55	NTN			
82,000	105,000	5,750	0,44	GS81116	58	NTN			
	115,000	8,500	0,99	GS81216	58	NTN			
	140,000	12,500	1,93	GS89316	58	NTN			
82,550	95,250	51,050	0,71	M1-126032	55	NTN			
	107,950	44,450	1,85	MR526828	41	NTN			
	107,950	50,800	2,12	MR526832	41	NTN			

d	D	B	Kg	Reference		Brands
95,000	180,000	46,000	1,98	NA5919	42	NTN
95,250	120,650	50,800	3,62	MR607632	41	NTN
97,000	104,000	21,300	0,13	KV97X104X21.3	40	NTN
	107,000	29,800	0,73	K97X107X29.8	40	NTN
100,000	107,000	20,700	0,37	K100X107X21	40	NTN
	107,000	30,700	0,18	K100X107X31	40	NTN
	108,000	26,700	0,19	K100X108X27	40	NTN
	108,000	29,700	0,60	K100X108X30	40	NTN
	110,000	30,000	1,11	1R100X110X30	55	NTN
	110,000	40,000	2,31	1R100X110X40	55	NTN
	110,000	63,000	0,81	1R100X110X63	55	NTN
	115,000	32,000	1,86	1R100X115X32	55	NTN
	115,000	40,000	2,31	1R100X115X40	55	NTN
	115,000	54,000	3,14	1R100X115X54	55	NTN
	116,000	1,000	0,04	AS100X116X1	58	NTN
	116,000	41,300	1,11	PK100X116X41.3	40	NTN
	120,000	26,000	1,47	NK100/26R	41	NTN
	120,000	30,000	1,39	RNA0-100X120X30	41	NTN
	120,000	35,000	1,32	RNA4917R	41	NTN
	120,000	36,000	2,07	NK100/36R	41	NTN
	120,000	44,700	0,75	PK100X120X44.7	40	NTN
	120,000	46,000	2,67	RNA5917	41	NTN
	120,000	63,000	3,60	RNA6917R	41	NTN
	120,000	90,000	2,11	RNA0-100X120X90	41	NTN
	130,000	30,000	2,94	NK110/30R+1R100X110X30	42	NTN
	130,000	40,000	1,36	NK110/40R+1R100X110X40	42	NTN
	135,000	1,000	0,15	AS1120	58	NTN
	135,000	4,000	0,29	AXK1120	57	NTN
	135,000	4,000	0,20	XS100X135X4	58	NTN
	135,000	7,000	1,01	WS81120	58	NTN
	135,000	11,000	0,68	K81120	57	NTN
	135,000	25,000	1,79	81120	56	NTN
	140,000	17,000	1,67	ARX100X140X17	59	NTN
	140,000	40,000	3,86	NA4920	42	NTN
	140,000	60,000	2,13	PK100X140X60	40	NTN
	150,000	11,500	2,58	WS81220	58	NTN
	150,000	15,000	1,60	K81220	57	NTN
	150,000	38,000	2,56	81220	56	NTN
	170,000	13,000	1,54	K89320	57	NTN
	170,000	14,500	1,46	WS89320	58	NTN
170,000	42,000	4,27	89320	56	NTN	
210,000	50,000	19,00	87420	56	NTN	
101,600	127,000	50,800	2,57	MR648032	41	NTN
	127,000	57,400	4,14	M1-648036	55	NTN
102,000	135,000	7,000	0,97	GS81120	58	NTN
103,000	150,000	11,500	2,45	GS81220	58	NTN
	170,000	14,500	3,19	GS89320	58	NTN
104,000	110,000	30,000	0,23	1R104X110X30	55	NTN
105,000	112,000	20,700	0,26	K105X112X21	40	NTN
	112,000	30,700	0,19	K105X112X31	40	NTN
	112,000	33,800	0,41	K105X112X33.8	40	NTN
	113,000	29,200	0,62	K105X113X29.2	40	NTN
	119,000	12,500	0,17	KJ105X119X12.5	40	NTN
	125,000	26,000	1,53	NK105/26R	41	NTN





d	D	B	Kg	Reference		Brands
105,000	125,000	35,000	2,09	RNA4918R	41	NTN
	125,000	36,000	1,43	NK105/36R	41	NTN
	125,000	46,000	2,84	RNA5918	41	NTN
	125,000	63,000	3,80	RNA6918R	41	NTN
107,950	133,350	50,800	1,36	MR688432	41	NTN
110,000	117,000	23,700	0,32	K110X117X24	40	NTN
	118,000	29,200	0,65	K110X118X29.2	40	NTN
	120,000	30,000	1,23	1R110X120X30	55	NTN
	120,000	40,000	1,10	1R110X120X40	55	NTN
	125,000	40,000	2,54	1R110X125X40	55	NTN
	125,000	54,000	3,46	1R110X125X54	55	NTN
	125,000	90,000	1,96	1R110X125X90	55	NTN
	125,000	120,000	5,18	1R110X125X120	55	NTN
	130,000	30,000	1,85	NK110/30R	41	NTN
	130,000	35,000	2,13	RNA4919R	41	NTN
	130,000	40,000	2,46	NK110/40R	41	NTN
	130,000	46,000	2,67	RNA5919	41	NTN
	130,000	59,700	2,34	PK110X130X59.7	40	NTN
	130,000	63,000	4,73	RNA6919	41	NTN
	130,000	63,000	3,89	RNA6919R	41	NTN
	140,000	30,000	3,27	NA4822	42	NTN
	145,000	1,000	0,16	AS1122	58	NTN
	145,000	4,000	0,31	AXK1122	57	NTN
	145,000	7,000	1,11	WS81122	58	NTN
	145,000	11,000	0,73	K81122	57	NTN
	145,000	25,000	3,12	81122	56	NTN
	150,000	40,000	6,21	NA4922	42	NTN
	160,000	11,500	1,86	WS81222	58	NTN
160,000	15,000	1,17	K81222	57	NTN	
160,000	38,000	4,82	81222	56	NTN	
190,000	15,000	0,16	K89322	57	NTN	
190,000	16,500	2,38	WS89322	58	NTN	
195,000	38,000	10,20	ARX110X195X38	59	NTN	
112,000	145,000	7,000	1,11	GS81122	58	NTN
113,000	160,000	11,500	1,76	GS81222	58	NTN
	190,000	16,500	2,32	GS89322	58	NTN
114,300	139,600	160,000	12,58	1R114.3X139.6X160	55	NTN
	152,400	57,150	2,62	MR729636	41	NTN
115,000	123,000	26,700	0,40	K115X123X27	40	NTN
	125,000	33,700	0,66	K115X125X34	40	NTN
	135,000	32,000	0,70	NKS115	41	NTN
	140,000	40,000	3,42	RNA4920	41	NTN
	140,000	54,000	4,48	RNA5920	41	NTN
226,000	36,000	9,14	ARX115X226X36	59	NTN	
120,000	127,000	23,700	0,51	K120X127X24	40	NTN
	127,000	33,700	0,24	K120X127X34	40	NTN
	130,000	30,000	1,35	1R120X130X30	55	NTN
	130,000	40,000	1,80	1R120X130X40	55	NTN
	135,000	45,000	3,11	1R120X135X45	55	NTN
	135,000	60,000	4,16	1R120X135X60	55	NTN
	140,000	30,000	1,34	RNA4822	41	NTN
	140,000	40,000	1,83	NK120/40	41	NTN
	150,000	30,000	3,54	NA4824	42	NTN
	150,000	80,000	6,46	NK120X150X80	41	NTN
	155,000	1,000	0,17	AS1124	58	NTN

												Brands		
d	D	B	Kg	Reference										
120,000	155,000	4,000	0,35	AXK1124	57	NTN								
	155,000	4,000	0,60	XS120X155X4	58	NTN								
	155,000	7,000	1,19	WS81124	58	NTN								
	155,000	11,000	0,79	K81124	57	NTN								
	155,000	25,000	3,48	81124	56	NTN								
	155,000	56,000	14,00	ARX120X292X56	59	NTN								
	165,000	10,000	3,92	NA5924	42	NTN								
	165,000	45,000	2,88	NA4924	42	NTN								
	170,000	12,000	3,12	WS81224	58	NTN								
	170,000	15,000	0,63	K81224	57	NTN								
	170,000	39,000	7,98	81224	56	NTN								
	210,000	54,000	17,82	89324	56	NTN								
	122,000	155,000	7,000	1,13	GS81124	58	NTN							
123,000	170,000	12,000	1,99	GS81224	58	NTN								
125,000	133,000	34,700	0,28	K125X133X35	40	NTN								
	150,000	40,000	3,66	RNA4922	41	NTN								
	150,000	54,000	5,19	RNA5922	41	NTN								
	175,000	115,000	7,50	KDX125X175X115	61	NTN								
127,000	165,100	57,150	2,89	MR8010436	41	NTN								
130,000	138,000	29,800	0,52	K130X138X29.8	40	NTN								
	145,000	32,000	1,57	1R130X145X32	55	NTN								
	145,000	35,000	2,59	1R130X145X35	55	NTN								
	145,000	63,000	2,82	1R130X145X63	55	NTN								
	150,000	30,000	2,20	RNA4824	41	NTN								
	150,000	40,000	2,94	NK130/40	41	NTN								
	150,000	50,000	5,07	1R130X150X50	55	NTN								
	150,000	52,000	3,51	1R130X150X52	55	NTN								
	150,000	67,000	6,82	1R130X150X67	55	NTN								
	165,000	35,000	3,61	NA4826	42	NTN								
	165,000	90,000	4,74	NK130X165X90	41	NTN								
	170,000	1,000	0,22	AS1126	58	NTN								
	170,000	5,000	0,82	AXK1126	57	NTN								
	170,000	9,000	1,94	WS81126	58	NTN								
	170,000	12,000	0,81	K81126	57	NTN								
	170,000	30,000	1,80	81126	56	NTN								
	180,000	50,000	11,75	NA4926	42	NTN								
	180,000	67,000	5,60	NA5926	42	NTN								
	187,000	13,000	4,22	WS81226	58	NTN								
	188,000	28,000	5,06	ARX130X188X28	59	NTN								
	190,000	19,000	3,07	K81226	57	NTN								
	190,000	45,000	12,60	81226	56	NTN								
	225,000	58,000	10,80	89326	56	NTN								
	270,000	63,000	38,80	87426	56	NTN								
	132,000	170,000	9,000	1,85	GS81126	58	NTN							
	133,000	190,000	13,000	4,29	GS81226	58	NTN							
135,000	143,000	34,700	0,31	K135X143X35	40	NTN								
	145,000	39,700	1,34	K135X145X39.7	40	NTN								
	160,000	40,000	2,66	NKS135	41	NTN								
	165,000	45,000	5,52	RNA4924	41	NTN								
	165,000	60,000	5,11	RNA5924	41	NTN								
188,000	120,000	10,59	NK135X188X121	41	NTN									
139,700	177,800	76,200	4,20	MR8811248	41	NTN								

												Brands	
d	D	B	Kg	Reference									
140,000	150,000	33,700	0,77	K140X150X33.7	40	NTN							
	155,000	32,000	0,92	1R140X155X32	55	NTN							
	155,000	35,000	2,78	1R140X155X35	55	NTN							
	155,000	42,000	2,22	1R140X155X42	55	NTN							
	155,000	100,000	2,71	1R140X155X100	55	NTN							
	155,300	42,000	3,60	1R140X155.3X42	55	NTN							
	160,000	50,000	5,42	1R140X160X50	55	NTN							
	160,000	52,000	5,63	1R140X160X52	55	NTN							
	160,000	67,000	4,78	1R140X160X67	55	NTN							
	175,000	35,000	1,93	NA4828	42	NTN							
	178,000	9,500	1,37	WS81128	58	NTN							
	180,000	1,000	0,23	AS1128	58	NTN							
	180,000	5,000	0,87	AXK1128	57	NTN							
	180,000	12,000	1,29	K81128	57	NTN							
	180,000	31,000	5,45	81128	56	NTN							
	190,000	50,000	12,47	NA4928	42	NTN							
	190,000	67,000	18,54	NA5928	42	NTN							
	197,000	13,500	1,55	WS81228	58	NTN							
	200,000	19,000	2,17	K81228	57	NTN							
	200,000	46,000	4,25	81228	56	NTN							
240,000	60,000	12,49	89328	56	NTN								
142,000	180,000	9,500	1,39	GS81128	58	NTN							
143,000	200,000	13,500	1,60	GS81228	58	NTN							
145,000	153,000	25,700	0,51	K145X153X26	40	NTN							
	153,000	27,700	0,50	K145X153X28	40	NTN							
	165,000	35,000	2,82	RNA4826	41	NTN							
	170,000	32,000	3,34	NK145/32	41	NTN							
	170,000	42,000	2,93	NK145/42	41	NTN							
150,000	160,000	45,700	1,78	K150X160X46	40	NTN							
	165,000	32,000	0,92	1R150X165X32	55	NTN							
	165,000	40,000	2,26	1R150X165X40	55	NTN							
	165,000	42,000	3,54	1R150X165X42	55	NTN							
	170,000	52,000	2,00	1R150X170X52	55	NTN							
	170,000	60,000	4,63	1R150X170X60	55	NTN							
	180,000	50,000	6,69	RNA4926	41	NTN							
	180,000	67,000	11,13	RNA5926	41	NTN							
	188,000	9,500	2,19	WS81130	58	NTN							
	190,000	1,000	0,17	AS1130	58	NTN							
	190,000	5,000	0,92	AXK1130	57	NTN							
	190,000	12,000	1,38	K81130	57	NTN							
	190,000	31,000	5,81	81130	56	NTN							
	190,000	40,000	5,50	NA4830	42	NTN							
	210,000	60,000	10,66	NA4930	42	NTN							
152,000	190,000	9,500	1,47	GS81130	58	NTN							
155,000	163,000	25,700	0,54	K155X163X26	40	NTN							
	163,000	35,700	0,71	K155X163X36	40	NTN							
	175,000	35,000	2,00	RNA4828	41	NTN							
	180,000	32,000	2,37	NK155/32	41	NTN							
	180,000	42,000	4,98	NK155/42	41	NTN							
160,000	170,000	45,700	1,19	K160X170X46									

d	D	B	Kg	Reference						
160,000	200,000	1,000	0,27	AS1132	58	NTN				
	200,000	5,000	0,96	AXK1132	57	NTN				
	200,000	12,000	1,49	K81132	57	NTN				
	200,000	31,000	6,13	81132	56	NTN				
	200,000	40,000	2,89	NA4832	42	NTN				
	200,000	105,000	24,00	NK160X200X105	41	NTN				
162,000	200,000	9,500	2,34	GS81132	58	NTN				
165,000	173,000	35,700	1,16	K165X173X36	40	NTN				
	190,000	40,000	4,81	RNA4830	41	NTN				
	190,000	42,000	1,68	NK165/42	41	NTN				
165,100	190,500	12,700	0,54	KR65	44	NTN				
170,000	185,000	45,000	3,14	1R170X185X45	55	NTN				
	190,000	60,000	7,81	1R170X190X60	55	NTN				
	210,000	60,000	12,96	RNA4930	41	NTN				
	215,000	34,000	7,93	81134	56	NTN				
	215,000	45,000	3,99	NA4834	42	NTN				
	237,000	16,500	2,76	WS81234	58	NTN				
	240,000	55,000	17,08	81234	56	NTN				
173,000	240,000	16,500	2,80	GS81234	58	NTN				
175,000	183,000	31,700	0,76	K175X183X32	40	NTN				
	200,000	40,000	5,11	RNA4832	41	NTN				
180,000	195,000	45,000	4,57	1R180X195X45	55	NTN				
	205,000	69,000	12,06	1R180X205X69	55	NTN				
	220,000	60,000	13,59	RNA4932	41	NTN				
	225,000	34,000	3,06	81136	56	NTN				
	225,000	45,000	4,26	NA4836	42	NTN				
	225,000	65,000	9,63	NK180X225X65	41	NTN				
	250,000	56,000	8,76	81236	56	NTN				
	250,000	69,000	25,74	NA4936	42	NTN				
184,150	231,775	76,200	7,41	MR11614648	41	NTN				
185,000	195,000	36,700	0,57	K185X195X37	40	NTN				
	215,000	45,000	7,59	RNA4834	41	NTN				
190,000	210,000	50,000	7,17	1R190X210X50	55	NTN				
	215,000	69,000	12,54	1R190X215X69	55	NTN				
	230,000	60,000	9,54	RNA4934	41	NTN				
	240,000	50,000	16,86	NA4838	42	NTN				
195,000	205,000	36,700	1,24	K195X205X37	40	NTN				
	225,000	45,000	8,01	RNA4836	41	NTN				
	235,000	12,500	10,00	ARX195X235X12.5	59	NTN				
	235,000	20,000	11,00	ARX195X235X20	59	NTN				
200,000	220,000	50,000	7,50	1R200X220X50	55	NTN				
	225,000	80,000	15,39	1R200X225X80	55	NTN				
	250,000	37,000	4,00	81140	56	NTN				
	250,000	50,000	17,52	NA4840	42	NTN				
	250,000	125,000	14,80	NK100X250X125	41	NTN				
	280,000	80,000	12,20	NA4940	42	NTN				
205,000	250,000	69,000	19,59	RNA4936	41	NTN				
210,000	220,000	41,700	2,25	K210X220X42	40	NTN				

d	D	B	Kg	Reference					
210,000	240,000	50,000	9,60	RNA4838	41	NTN			
215,000	260,000	69,000	13,64	RNA4938	41	NTN			
220,000	230,000	41,700	2,37	K220X230X42	40	NTN			
	240,000	50,000	8,28	1R220X240X50	55	NTN			
	240,000	54,000	3,04	1R220X240X54	55	NTN			
	245,000	80,000	11,22	1R220X245X80	55	NTN			
	250,000	50,000	10,05	RNA4840	41	NTN			
225,000	270,000	50,000	6,37	NA4844	42	NTN			
	280,000	80,000	20,60	RNA4940	41	NTN			
230,000	280,000	60,000	7,57	NK130X280X60	41	NTN			
240,000	250,000	41,700	2,55	K240X250X42	40	NTN			
	265,000	60,000	18,30	1R240X265X60	55	NTN			
	265,000	80,000	6,10	1R240X265X80	55	NTN			
	270,000	50,000	10,80	RNA4844	41	NTN			
	300,000	60,000	30,00	NA4848	42	NTN			
	360,000	114,300	44,90	NA0-240X360X114.3	42	NTN			
242,000	260,000	40,000	2,21	1R242X260X40	55	NTN			
245,000	300,000	80,000	33,30	RNA4944	41	NTN			
260,000	285,000	60,000	9,82	1R260X285X60	55	NTN			
	285,000	120,000	9,84	1R260X285X120	55	NTN			
	290,000	100,000	9,94	1R260X290X100	55	NTN			
	320,000	60,000	32,40	NA4852	42	NTN			
265,000	280,000	49,700	5,30	K265X280X50	40	NTN			
	300,000	60,000	16,47	RNA4848	41	NTN			
	320,000	80,000	23,60	RNA4948	41	NTN			
280,000	305,000	69,000	6,77	1R280X305X69	55	NTN			
	320,000	13,000	1,88	ARX280X320X13	59	NTN			
	350,000	53,000	11,90	81156	56	NTN			
	350,000	69,000	31,00	NA4856	42	NTN			
282,000	300,000	45,000	2,89	1R282X300X45	55	NTN			
285,000	320,000	60,000	17,67	RNA4852	41	NTN			
290,000	360,000	100,000	31,80	RNA4952	41	NTN			
300,000	330,000	80,000	27,24	1R300X330X80	55	NTN			
	380,000	80,000	44,00	NA4860	42	NTN			
305,000	350,000	69,000	18,78	RNA4856	41	NTN			
320,000	350,000	80,000	29,40	1R320X350X80	55	NTN			
	400,000	80,000	46,40	NA4864	42	NTN			
330,000	380,000	80,000	25,56	RNA4860	41	NTN			
332,000	350,000	46,000	3,46	1R332X350X46	55	NTN			
340,000	460,000	96,000	50,00	81268	56	NTN			
350,000	400,000	80,000	29,00	RNA4864	41	NTN			

						 Brands	
d	D	B	Kg	Reference			
360,000	400,000	118,000	22,00	1R360X400X118	55	NTN	
	440,000	80,000	25,70	NA4872	42	NTN	
370,000	420,000	80,000	14,12	RNA4868	41	NTN	
380,000	460,000	118,000	14,00	RNA4968	41	NTN	
	480,000	100,000	44,50	NA4876	42	NTN	
390,000	440,000	80,000	14,80	RNA4872	41	NTN	
415,000	480,000	100,000	26,04	RNA4876	41	NTN	
440,000	490,000	160,000	93,00	1R440X490X160	55	NTN	
490,000	600,000	160,000	194,20	RNA4988	41	NTN	
500,000	670,000	135,000	298,00	812/500	56	NTN	



Classification by dimensions – Classement par dimensions
Klassifizierung nach Abmessungen – Classificazione per dimensione
Clasificación por dimensiones – Classificação por dimensões
Классификация по размерам – Klasyfikacja wg wymiarów

 Accessories

 Zubehör

 Accesorios

 Аксессуары

 Accessoires

 Accessori

 Acessórios

 Akcesoria

Adapter sleeves / Manchons de serrage / Spannhülsen / Bussole di trazione / Manguitos de apriete / Bucha de fixação / Закрепительные втулки / Tuleje wciągane

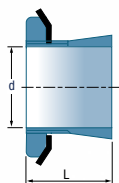

d	Reference	L	Kg
17	H204	24	0,04
	H304	28	0,05
20	H205	26	0,07
	H305	29	0,08
	H2305	35	0,09
25	H206	27	0,10
	H306	31	0,11
	H2306	38	0,13
30	H207	29	0,13
	H307	35	0,14
	H2307	43	0,17
35	H208	31	0,17
	H308	36	0,19
	H2308	46	0,22
40	H209	33	0,23
	H309	39	0,25
	H2309	50	0,28
45	H210	35	0,27
	H310	42	0,30
	H2310	55	0,36
50	H211	37	0,31
	H311	45	0,35
	H2311	59	0,42
55	H212	38	0,35
	H312	47	0,39
	H2312	62	0,48
60	H213	40	0,40
	H313	50	0,46
	H2313	65	0,56
60	H214	41	0,59
	H314	52	0,72
	H2314	68	0,90
65	H215	43	0,71
	H315	55	0,83
	H2315	73	1,05
70	H216	46	0,88
	H316	59	1,03
	H2316	18	1,28
75	H217	50	1,02
	H317	63	1,18
	H2317	82	1,45

d	Reference	L	Kg
80	H218	52	1,19
	H318	65	1,37
	H2318	86	1,69
85	H219	55	1,37
	H319	68	1,56
	H2319	90	1,92
90	H220	58	1,49
	H320	71	1,69
	H2320	97	2,15
	H3120	76	1,80
100	H222	63	1,93
	H322	77	2,18
	H2322	105	2,74
	H3122	81	2,25
110	H2324	112	3,19
	H3024	72	1,93
	H3124	88	2,64
115	H2326	121	4,60
	H3026	80	2,85
	H3126	92	3,66
125	H2328	131	5,55
	H3028	82	3,16
	H3128	97	4,34
135	H2330	139	6,63
	H3030	87	3,89
	H3130	111	5,52
140	H2332	147	9,14
	H3032	93	5,21
	H3132	119	7,67
150	H2334	154	10,20
	H3034	101	5,99
	H3134	122	8,38
160	H2336	161	11,30
	H3036	109	6,83
	H3136	131	9,50
170	H2338	169	12,60
	H3038	112	7,45
	H3138	141	10,80
180	H2340	176	13,90
	H3040	120	9,19
	H3140	150	12,10



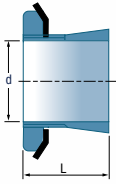

d	Reference	L	Kg
200	H2344H	186	17,00
	H3044H	126	10,30
	H3144	161	14,70
220	H2348H	199	20,00
	H3048H	133	13,20
	H3148H	172	17,60
240	H2352H	211	24,50
	H3052H	145	15,30
	H3152H	190	22,30
260	H2356H	224	28,40
	H3056H	152	17,70
	H3156H	195	25,10
280	H3060H	168	22,80
	H3160H	208	30,20
	H3260H	240	34,10
300	H3064H	171	24,60
	H3164H	226	34,90
320	H3068H	187	28,70
	H3168H	254	50,00
340	H3072H	188	30,50
	H3172	259	56,00
360	H3076H	193	35,80
380	H3080H	210	41,30

Withdrawal sleeves / Manchons de démontage / Abziehhülsen / Bussole di pressione / Manguitos de desmontaje / Bucha de desmontagem / Стяжные втулки / Tuleje wciskane

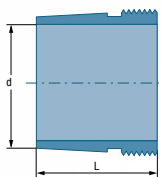

d	Reference	L	Kg
35	AH 308	29	0,090
	AH 2308	40	0,128
40	AH 309	31	0,109
	AH 2309	44	0,164
45	AHX 310	35	0,137
	AHX 2310	50	0,209
50	AHX 311	37	0,161
	AHX 2311	54	0,253
55	AHX 312	40	0,189
	AHX 2312	58	0,297
60	AH 313 G	42	0,253
	AH 2313 G	61	0,395
65	AH 314 G	43	0,280
	AHX 2314 G	64	0,466
70	AH 315G	45	0,031
	AHX 2315 G	68	0,534
75	AH 316	48	0,365
	AHX 2316	71	0,597
80	AHX 317	52	0,429
	AHX 2317	74	0,670
85	AHX 318	53	0,461
	AHX 3218	63	0,576
	AHX 2318	79	0,779
90	AHX 349	57	0,532
	AHX 2319	85	0,886
95	AHX 320	59	0,582
	AHX 2130	64	0,650
	AHX 3220	73	0,767
	AHX 2320	90	0,998
100	AHX 3122/100	68	0,760
	AHX 3222/100G	73	1,040
105	AHX 322	63	0,663
	AHX 3122	68	0,760
	AH 24122	82	0,730
	AHX 3222 G	82	1,040
	AHX 2322 G	98	1,350
110	AHX 3024/110	60	0,750
	AHX 3124/110	75	0,950

d	Reference	L	Kg
115	AHX 3024	60	0,750
	AH 24024	73	0,650
	AHX 3124	75	0,950
	AHX 3224 G	90	1,300
	AH 24124	93	1,000
	AHX 2324 G	105	1,600
120	AHX 3026/120	67	0,930
	AHX 3126/120	78	1,080
	AHX 2326/120 G	118	1,970
125	AHX 3026	67	0,930
	AHX 3126	78	1,080
	AH 24026	83	0,880
	AH 24126	94	1,150
	AHX 3226 G	98	1,580
	AHX 2326 G	115	1,970
130	AHX 3028/130	68	1,010
	AHX 3128/130	83	1,280
	AHX 2328/130 G	125	2,330
135	AHX 3028	68	1,010
	AH 24028	83	0,910
	AHX 3128	83	1,280
	AH 24128	99	1,250
	AHX 3228 G	104	1,840
	AHX 2328 G	125	2,330
140	AHX 3030/140	72	1,150
	AHX 3130/140	96	1,790
	AHX 3230/140 G	114	2,220
145	AHX 3030	72	1,150
	AH 24030	90	1,040
	AHX 3130 G	96	1,790
	AHX 3230 G	114	2,220
	AH 24130	115	1,560
	AHX 2330 G	135	2,820
150	AH 3032	77	2,060
	AH 24032	95	2,330
	AH 3132 G	103	3,210
	AH 24132	124	3,000
	AH 3232 G	124	4,080
	AH 2332 G	140	4,720
160	AH 3034	85	2,430
	AH 3134 G	104	3,400
	AH 24034	106	2,800
	AH 24134	125	3,210
	AH 3234 G	134	4,800
	AH 2334 G	146	5,250



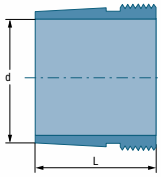

d	Reference	L	Kg
170	AH 3036	92	2,810
	AH 2236 G	105	3,390
	AH 24036	116	3,200
	AH 3136 G	116	3,880
	AH 24136	134	3,750
	AH 3236 G	140	5,320
	AH 2336 G	154	5,830
180	AH 3038 G	96	3,320
	AH 2238 G	112	4,200
	AH 24038	118	3,500
	AH 3138 G	125	4,890
	AH 3238 G	145	5,900
	AH 24138	146	4,280
	AH 2338 G	160	6,630
190	AH 3040 G	102	3,800
	AH 2240	118	4,680
	AH 24040	127	3,930
	AH 3140	134	5,490
	AH 3240	153	6,680
	AH 24140	158	5,100
200	AH 2340	170	7,540
	AOH 3044 G	111	7,290
	AOH 2244	130	9,100
	AOH 24044	138	8,200
	AOH 3144	145	10,400
	AOH 24144	170	10,500
220	AOH 2344	181	13,500
	AOH 3048	116	8,750
	AOH 24048	138	9,290
	AOH 3148	154	12,000
	AOH 24148	180	13,000
AOH 2348	189	15,500	

d	Reference	L	Kg
240	AOH 3052	128	10,700
	AOH 24052 G	162	12,700
	AOH 3152 G	172	15,500
	AOH 24152	202	16,000
	AOH 2352 G	205	18,900
260	AOH 3056	131	12,000
	AOH 24056 G	162	13,700
	AOH 3156 G	175	17,100
	AOH 24156	202	17,300
280	AOH 2356 G	212	21,300
	AOH 3060	145	14,400
	AOH 24060 G	184	16,800
	AOH 3160 G	192	20,400
300	AOH 24160	224	20,800
	AOH 3260 G	228	23,400
	AOH 3064 G	149	15,600
320	AOH 3164 G	209	24,300
	AOH 24164	242	24,200
	AOH 3068 G	162	19,100
340	AOH 3168 G	225	28,300
	AOH 24168	269	29,000
	AOH 3072 G	167	20,400
360	AOH 3172	229	33,000
	AH 24172H	269	30,800
	AOH 3076 G	176	22,700
380	AOH 3080 G	183	26,100

**Locknuts / Ecrous / Muttern / Ghiere /
Tuercas / Porcas / Гайки / Nakrętki**

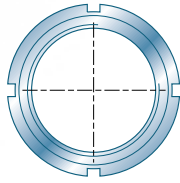

d	Reference	Thread	Kg
10	KM0	M10 x 0.75	0,005
12	KM1	M12 x 1	0,007
15	KM2	M15 x 1	0,010
17	KM3	M17 x 1	0,013
20	KM4	M20 x 1	0,019
25	KM5	M25 x 1,5	0,025
30	KM6	M30 x 1,5	0,043
35	KM7	M35 x 1,5	0,053
40	KM8	M40 x 1,5	0,085
45	KM9	M45 x 1,5	0,120
50	KM10	M50 x 1,5	0,150
55	KM11	M55 x 2	0,160
60	KM12	M60 x 2	0,170
65	KM13	M65 x 2	0,200
70	KM14	M70 x 2	0,240
75	KM15	M75 x 2	0,290
80	KM16	M80 x 2	0,400
85	KM17	M85 x 2	0,450
90	KM18	M90 x 2	0,560
95	KM19	M95 x 2	0,660
100	KM20	M100 x 2	0,700
105	KM21	M105 x 2	0,850
110	KM22	M110 x 2	0,970
115	KM23	M115 x 2	1,010
120	KM24	M120 x 2	1,080
125	KM25	M125 x 2	1,190
130	KM26	M130 x 2	1,250
135	KM27	M135 x 2	1,550
140	KM28	M140 x 2	1,560
145	KM29	M145 x 2	2,000
150	KM30	M150 x 2	2,030
155	KM31	M155 x 2	2,210
160	KM32	M160 x 2	2,590
165	KM33	M165 x 2	2,700

d	Reference	Thread	Kg
170	KM34	M170 x 2	2,800
180	KM35	M180 x 2	3,070
190	KM36	M190 x 2	3,390
200	KM37	M200 x 2	3,690
205	HML41T	Tr205x4	3,430
210	HM42T	Tr210x4	4,750
215	HML43T	Tr215x4	3,720
220	HM3044	Tr220x4	3,090
220	HM44T	Tr220x4	5,350
230	HM46T	Tr230x4	5,800
240	HM3048	Tr240x4	5,160
240	HM48T	Tr240x4	6,200
260	HM3052	Tr2460x4	5,670
250	HM50T	Tr250x4	7,000
260	HM52T	Tr260x4	8,400
280	HM3056	Tr280x4	6,780
280	HM56T	Tr280x4	9,600
300	HM3060	Tr300x4	9,620
300	HM3160	Tr300x4	11,700
320	HM3064	Tr320x5	9,940
320	HM3164	Tr320x5	13,000
340	HM3068	Tr340x5	11,700
340	HM3168	Tr340x5	23,000
360	HM3072	Tr360x5	12,000
360	HM3172	Tr360x5	25,000
380	HM3076	Tr380x5	14,900
380	HM3176	Tr380x5	30,800
400	HM3080	Tr400x5	16,900
420	HM3084	Tr420x5	17,400



**Lock-washer / Rondelles de blocage / Sicherungsbleche /
Rondelle di sicurezza / Arandela freno / Anilha de pressão /
Стопорные шайбы / Podkładki blokujące**

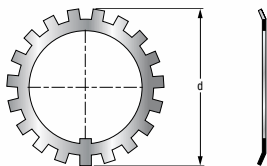

d	Reference	Kg
10	MB0	0,130
12	MB1	0,200
15	MB2	0,250
17	MB3	0,300
20	MB4	0,400
25	MB5	0,600
30	MB6	0,800
35	MB7	1,100
40	MB8	1,300
45	MB9	1,500
50	MB10	1,600
55	MB11	2,200
60	MB12	2,500
65	MB13	3,000
70	MB14	3,300
75	MB15	3,600
80	MB16	4,600
85	MB17	5,300
90	M18	6,200
95	M19	6,700
100	M20	7,700
105	MB21	8,300
110	MB22	9,400
115	MB23	10,800
120	MB24	10,800
125	MB25	11,800
130	MB26	11,500
140	MB28	14,200
150	MB30	18,000
160	MB32	22,900
170	MB34	24,700
180	MB36	26,800
190	MB38	27,800
200	MB40	29,300
200	MBL40	22,000
200	MB44	35,000
240	MB48	45,000
260	MB52	65,000
280	MB56	105,000

**Locking tabs / Etriers de blocage / Sicherungsbügel /
Staffe di bloccaggio / Brida de bloqueio / Estribo de fixação /
Блокирующие хомуты / Obejmy blokujące**

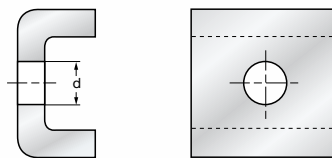

d	Reference	Kg
7	MS3044	2,100
9	MS3048	2,300
9	MS3052	2,300
9	MS3056	3,000
9	MS3060	3,200
9	MS3064	4,600
9	MS3068	4,600
9	MS3072	5,000
12	MS3076	5,300
12	MS3080	5,300
12	MS3160	3,800
12	MS3164	5,400
14	MS3168	6,700
14	MS3172	6,700

Self-locking precision nuts / Ecrous auto-bloquants de précision / Selbstsichernde Präzisionsmuttern / Ghiere autobloccanti di precisione / Tuercas de precisión / Porcas autobloqueadoras de precisão / Самоблокирующиеся прецизионные гайки / Precyzyjne nakrętki samohamowne

B range / Gamme B / Reihe B / Serie B / Gama B / Gama B / Серия B / Gama B

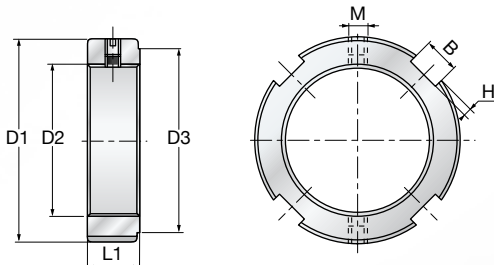

	D1	D2	D3	L1	M	B	H
B12	22	M12x1	18	8	M4	3	2
B15	25	M15x1	21	8	M4	3	2
B17	28	M17x1	24	10	M5	4	2
B20/1	32	M20x1	28	10	M5	4	2
B20/1,5	32	M20x1,5	28	10	M5	4	2
B25	38	M25x1,5	33	12	M5	5	2
B30	45	M30x1,5	40	12	M5	5	2
B35	52	M35x1,5	47	12	M5	5	2
B40	58	M40x1,5	52	14	M6	6	2,5
B45	65	M45x1,5	59	14	M6	6	2,5
B50	70	M50x1,5	64	14	M6	6	2,5
B55	75	M55x2	68	16	M8	7	3
B60	80	M60x2	73	16	M8	7	3
B65	85	M65x2	78	16	M8	7	3
B70	92	M70x2	85	18	M8	8	3,5
B75	98	M75x2	90	18	M8	8	3,5
B80	105	M80x2	95	18	M8	8	3,5
B85	110	M85x2	100	18	M8	8	3,5
B90	120	M90x2	110	20	M8	10	4
B95	125	M95x2	115	20	M8	10	4
B100	130	M100x2	120	20	M8	10	4
B110	145	M110x2	133	22	M8	12	5
B120	155	M120x2	138	24	M10	12	5
B150	195	M150x2	171	26	M12	14	6
B160	210	M160x3	188	28	M12	16	7
B180	230	M180x3	203	30	M12	18	8
B190	240	M190x3	214	30	M12	18	8

BR range / Gamme BR / Reihe BR / Serie BR / Gama BR / Gama BR / Серия BR / Gama BR

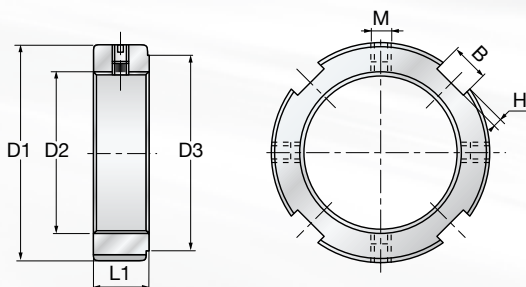

	BR 25	BR 30	BR 35	BR 40	BR 45	BR 50	BR 55	BR 60	BR 65	BR 70	BR 75	BR 80	BR 85	BR 90	BR 95	BR100	BR140
D1	38	45	52	58	65	70	75	80	85	92	98	105	110	120	125	130	180
D2	M25x1,5	M30x1,5	M35x1,5	M40x1,5	M45x1,5	M50x1,5	M55x2	M60x2	M65x2	M70x2	M75x2	M80x2	M85x2	M90x2	M95x2	M100x2	M140x2
D3	33	40	47	52	59	64	68	73	78	85	90	95	100	110	115	120	160
L1	12	12	12	14	14	14	16	16	16	18	18	18	18	20	20	20	26
M	M5	M5	M5	M6	M6	M6	M8	M8	M8	M8	M8	M8	M8	M8	M8	M8	M12
B	5	5	5	6	6	6	7	7	7	8	8	8	8	10	10	10	14
H	2	2	2	2,5	2,5	2,5	3	3	3	3,5	3,5	3,5	3,5	4	4	4	6



**BP range / Gamme BP / Reihe BP / Serie BP /
Gama BP / Гамма BP / Серия BP / Гамма BP**

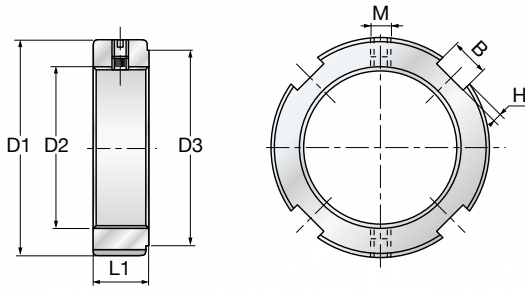

	BP 20/1	BP 20/1,5	BP 25	BP 30	BP 35	BP 40	BP 45	BP 50	BP 55	BP 60	BP 65	BP 70	BP 75	BP 80	BP 85	BP 90	BP 95	BP 100
D1	38	38	45	52	58	62	68	75	88	98	105	110	125	140	150	155	160	160
D2	M20x1	M20x1,5	M25x1,5	M30x1,5	M35x1,5	M40x1,5	M45x1,5	M50x1,5	M55x2	M60x2	M65x2	M70x2	M75x2	M80x2	M85x2	M90x2	M95x2	M100x2
D3	28	28	33	40	47	52	59	64	68	73	78	85	90	95	100	110	115	120
L1	20	20	20	22	22	22	24	25	32	32	32	35	38	38	38	38	38	40
M	M5	M5	M6	M6	M6	M8	M8	M8	M8	M8	M8	M8	M10	M10	M10	M10	M10	M10
B	5	5	5	5	6	6	6	7	8	8	8	8	10	12	12	12	12	12
H	2	2	2	2	2,5	2,5	2,5	3	3,5	3,5	3,5	3,5	4	5	5	5	5	5

**BPR range / Gamme BPR / Reihe BPR / Serie BPR /
Gama BPR / Гамма BPR / Серия BPR / Гамма BPR**

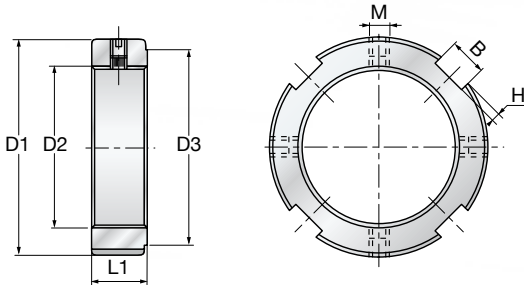

	BPR 20/1	BPR 20/1,5	BPR 25	BPR 30	BPR 35	BPR 40	BPR 45	BPR 50	BPR 55	BPR 60	BPR 65	BPR 70	BPR 75	BPR 80	BPR 85	BPR 90	BPR 95	BPR 100
D1	38	38	45	52	58	62	68	75	88	98	105	110	125	140	150	155	160	160
D2	M20x1	M20x1,5	M25x1,5	M30x1,5	M35x1,5	M40x1,5	M45x1,5	M50x1,5	M55x2	M60x2	M65x2	M70x2	M75x2	M80x2	M85x2	M90x2	M95x2	M100x2
D3	28	28	33	40	47	52	59	64	68	73	78	85	90	95	100	110	115	120
L1	20	20	20	22	22	22	24	25	32	32	32	35	38	38	38	38	38	40
M	M5	M5	M6	M6	M6	M8	M8	M8	M8	M8	M8	M8	M10	M10	M10	M10	M10	M10
B	5	5	5	5	6	6	6	7	8	8	8	8	10	12	12	12	12	12
H	2	2	2	2	2,5	2,5	2,5	3	3,5	3,5	3,5	3,5	4	5	5	5	5	5

**TB range / Gamme TB / Reihe TB / Serie TB /
Гамма TB / Гамма TB / Серия TB / Гамма TB**

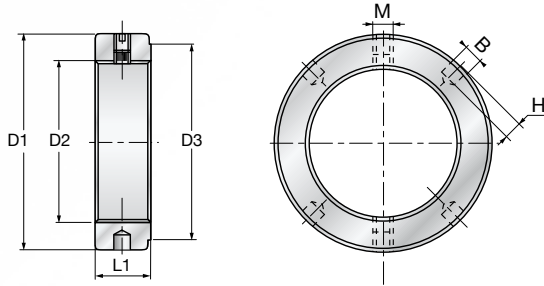

	TB 20/1	TB 20/1,5	TB 25	TB 30	TB 35	TB 40	TB 45	TB 50	TB 55	TB 60	TB 65	TB 70	TB 75	TB 80	TB 85	TB 90	TB 95	TB100
D1	32	32	38	45	52	58	65	70	75	80	85	92	98	105	110	120	125	130
D2	M20x1	M20x1,5	M25x1,5	M30x1,5	M35x1,5	M40x1,5	M45x1,5	M50x1,5	M55x2	M60x2	M65x2	M70x2	M75x2	M80x2	M85x2	M90x2	M95x2	M100x2
D3	28	28	33	40	47	52	59	64	68	73	78	85	90	95	100	110	115	120
L1	10	10	12	12	12	14	14	14	16	16	16	18	18	18	18	20	20	20
M	M5	M5	M5	M5	M5	M6	M6	M6	M8	M8	M8	M8	M8	M8	M8	M8	M8	M8
B	5	5	5	5	5	6	6	6	6	6	6	8	8	8	8	8	8	8
H	3,5	3,5	4	4,5	5	5,5	6	6	6	6	6	7	7	7	8	8	8	8

**TBR range / Gamme TBR / Reihe TBR / Serie TBR /
Гамма TBR / Гамма TBR / Серия TBR / Гамма TBR**

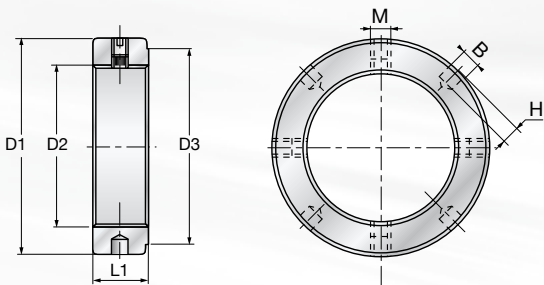

	TBR 25	TBR 30	TBR 35	TBR 40	TBR 45	TBR 50	TBR 55	TBR 60	TBR 65	TBR 70	TBR 75	TBR 80	TBR 85	TBR 90	TBR 95	TBR 100
D1	38	45	52	58	65	70	75	80	85	92	98	105	110	120	125	130
D2	M25x1,5	M30x1,5	M35x1,5	M40x1,5	M45x1,5	M50x1,5	M55x2	M60x2	M65x2	M70x2	M75x2	M80x2	M85x2	M90x2	M95x2	M100x2
D3	33	40	47	52	59	64	68	73	78	85	90	95	100	110	115	120
L1	12	12	12	14	14	14	16	16	16	18	18	18	18	20	20	20
M	M5	M5	M5	M6	M6	M6	M8	M8	M8	M8	M8	M8	M8	M8	M8	M8
B	5	5	5	6	6	6	6	6	6	8	8	8	8	8	8	8
H	4	4,5	5	5,5	6	6	6	6	6	7	7	7	8	8	8	8

**TBP range / Gamme TBP / Reihe TBP / Serie TBP /
Гамма TBP / Гамма TBP / Серия TBP / Гамма TBP**

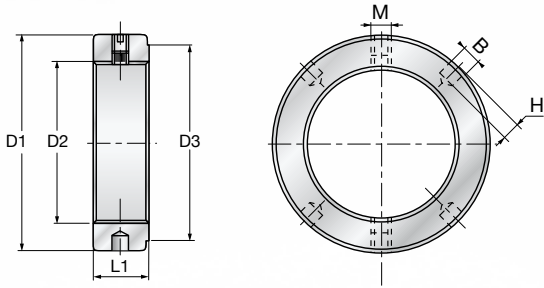

	TBP 20/1	TBP 20/1,5	TBP 25	TBP 30	TBP 35	TBP 40	TBP 45	TBP 50	TBP 55	TBP 60	TBP 65	TBP 70	TBP 75	TBP 80	TBP 85	TBP 90	TBP 95	TBP100
D1	38	38	45	52	58	62	68	75	88	98	105	110	125	140	150	155	160	160
D2	M20x1	M20x1,5	M25x1,5	M30x1,5	M35x1,5	M40x1,5	M45x1,5	M50x1,5	M55x2	M60x2	M65x2	M70x2	M75x2	M80x2	M85x2	M90x2	M95x2	M100x2
D3	28	28	33	40	47	52	59	64	68	73	78	85	90	95	100	110	115	120
L1	20	20	20	22	22	22	24	25	32	32	32	35	38	38	38	38	38	40
M	M5	M5	M6	M6	M6	M8	M8	M8	M8	M8	M8	M8	M10	M10	M10	M10	M10	M10
B	5	5	5	5	5	6	6	6	6	8	8	8	8	8	8	8	8	8
H	3,5	3,5	4	4,5	5	5,5	6	6	6	6	6	7	7	7	8	8	8	8

**TBPR range / Gamme TBPR / Reihe TBPR / Serie TBPR /
Гамма TBPR / Гамма TBPR / Серия TBPR / Гамма TBPR**

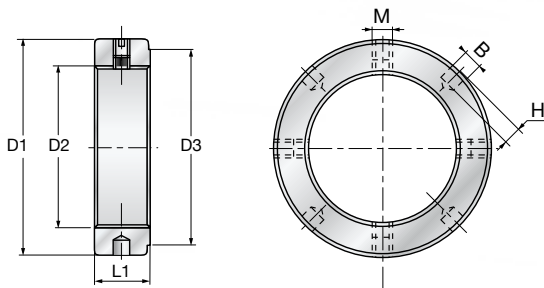

	TBPR 20/1	TBPR 20/1,5	TBPR 25	TBPR 30	TBPR 35	TBPR 40	TBPR 45	TBPR 50	TBPR 55	TBPR 60	TBPR 65	TBPR 70	TBPR 75	TBPR 80	TBPR 85	TBPR 90	TBPR 95	TBPR100
D1	38	38	45	52	58	62	68	75	88	98	105	110	125	140	150	155	160	160
D2	M20x1	M20x1,5	M25x1,5	M30x1,5	M35x1,5	M40x1,5	M45x1,5	M50x1,5	M55x2	M60x2	M65x2	M70x2	M75x2	M80x2	M85x2	M90x2	M95x2	M100x2
D3	28	28	33	40	47	52	59	64	68	73	78	85	90	95	100	110	115	120
L1	20	20	20	22	22	22	24	25	32	32	32	35	38	38	38	38	38	40
M	M5	M5	M6	M6	M6	M8	M8	M8	M8	M8	M8	M8	M10	M10	M10	M10	M10	M10
B	5	5	5	5	5	6	6	6	6	8	8	8	8	8	8	8	8	8
H	3,5	3,5	4	4,5	5	5,5	6	6	6	6	6	7	7	7	8	8	8	8

